



WELLINGTON, NEW ZEALAND

PURSUANT to *section 152* of the Land Transport Act 1998

I, *Harry James Duynhoven*, Minister for Transport Safety,

HEREBY make the following ordinary Rule:

Land Transport Rule: Traffic Control Devices 2004

SIGNED AT Wellington

This 6th day of December 2004

Harry James Duynhoven

Minister for Transport Safety

Land Transport Rule
Traffic Control Devices 2004

Rule 54002/2004

As at 1 May 2021

Land Transport Rule

Traffic Control Devices 2004

As at 1 May 2021

Contents

Compilation notes	1
Part 1 Rule requirements	2
Section 1 Application	2
1.1 Title	2
1.2 Scope of the rule	2
1.3 Objective of the rule	2
1.4 Date when rule comes into force	2
1.5 Application of rule provisions	2
Section 2 Role of road controlling authorities	3
Section 3 General requirements for traffic control devices	3
3.1 General safety requirements for traffic control devices	3
3.2 Use of traffic control devices	4
3.3 Matters to be taken into account when providing, modifying and removing traffic control devices	5
3.4 Trials of traffic control devices	5
Section 4 Traffic signs	7
4.1 Purposes of traffic signs	7
4.2 Provision of traffic signs	8
4.3 Types of traffic sign	10
4.4 General requirements for traffic signs	10
4.5 Specific requirements for traffic signs	14
4.6 Variable traffic signs	15
4.7 Advertising signs	15
Section 5 Markings	15
5.1 Purposes of markings	15
5.2 Provision of markings	15
5.3 Method of marking	16
5.4 General requirements for markings	16
5.5 Markings intended for advertising purposes or not connected with use of a road	18
5.6 Requirements for roadway art	18
5.7 Powers of Agency over markings	20
5.8 Powers of Agency over lower risk environments	21
5.9 Road controlling authority may appeal a notice from Agency	21
Section 6 Traffic signals	22

6.1	Types and purposes of traffic signals	22
6.2	Provision of traffic signals	22
6.3	General requirements for traffic signals	23
6.4	Steady vehicle displays in the form of a continuous display	25
6.5	Flashing vehicle displays	32
6.6	Pedestrian displays	34
Section 7	Channelling traffic	36
7.1	Provision of traffic control devices for channelling traffic	36
7.2	Centre-lines	36
7.2A	Wide centre-lines	37
7.3	No-passing lines	38
7.4	Flush medians	39
7.5	Edgelines	39
7.6	Shoulder markings	39
7.7	Traffic islands	39
7.8	Turn bays	41
7.9	Kerbs, slow points, chicanes and other structures	41
7.10	Delineators	42
7.11	Lane lines	42
7.12	Lanes	42
7.13	Variable lane control signs	43
Section 8	Pedestrian crossings, school crossing points, school patrols and other pedestrian facilities	45
8.1	Provision of traffic control devices for pedestrians	45
8.2	Pedestrian crossings	45
8.3	School patrols	48
8.4	School crossing points	49
8.5	Pedestrian traffic signals	51
8.6	Provision and maintenance of pedestrian crossings and school crossing points	51
8.7	Removal of pedestrian crossings and indications of pedestrian crossings	51
8.8	Other pedestrian facilities	52
Section 9	Level crossings	52
9.1	Interpretation	52
9.2	Traffic control devices at level crossings	52
9.3	Marking level crossings	53
9.4	Traffic signs, traffic signals and limit lines at level crossings	53
9.5	Exception in relation to requirements for vehicles to stop at specified level crossings	55
Section 10	Intersections	55
10.1	Intersections to be controlled	55
10.2	Intersections controlled by stop signs	56
10.3	Intersections controlled by give-way signs	56
10.4	Intersections controlled by roundabouts	56
10.5	Intersections controlled by traffic signals	57

10.6	‘Keep Clear’ zone at intersections	58
Section 11	Traffic control devices for special classes of vehicle and road user	58
11.1	Provision of signs and markings	58
11.2	Special vehicle lanes	59
11.3	Light-rail vehicle facilities	59
11.4	Facilities for cycles, wheeled recreational devices and mobility devices	60
11.5	Special motor vehicle facilities	61
11.6	Stock traffic	62
11.7	Manually-controlled stop signs	62
11.8	Barrier arms	63
Section 12	Stopping, standing and parking	63
12.1	Requirement to indicate prohibition on stopping	63
12.2	Means of indicating prohibition on stopping	64
12.3	Requirement to indicate restriction on parking	65
12.4	Types and means of indicating parking restrictions	65
12.5	General requirements for signing parking restrictions	69
12.6	Application of parking signs	71
12.7	General requirements for marking parking restrictions	72
Section 13	Responsibilities, functions and powers	73
13.1	Responsibilities of road controlling authorities	73
13.2	Responsibilities of rail access providers	73
13.3	Responsibilities of operators of manually-controlled stop signs	73
13.4	Responsibilities of Boards of Trustees	73
13.5	Responsibilities of school patrols	73
13.6	Responsibilities of school wardens	73
13.6A	Responsibilities of school bus operators	73
13.7	Responsibilities of all persons	74
13.8	Functions and powers of the Agency	74
13.9	Powers of the Police	75
Part 2 Definitions		77
Part 3 Schedules		88
Schedule 1 Signs		88
Schedule 2 Markings		329
[Ref. Cl. 7.12(3)(a)]		359
Schedule 3 Traffic signals		366

Compilation notes

1 General

This is a compilation of *Land Transport Rule: Traffic Control Devices 2004* that incorporates all the amendments to that Rule as at the date of the last amendment to it.

2 Format changes

Format changes to compilations are made so that the format of the compilation is consistent with current drafting practice, including:

- changes to the setting out of provisions, tables, and schedules:
- the repositioning of headings or notes:
- changes to typeface and type size:
- the addition or removal of boldface, italics, and similar textual attributes:
- the addition or removal of quote marks:
- changes to the case of letters or words:
- addition of history and editorial notes.

3 Amendments incorporated in this reprint

Land Transport Rule: Traffic Control Devices Amendment 2021

Land Transport Rule: Traffic Control Devices Amendment 2020

Land Transport Rule: Traffic Control Devices Amendment 2019

Land Transport Amendment Act 2017

Land Transport Rule: Traffic Control Devices Amendment 2017

Land Transport Rule: Traffic Control Devices Amendment 2016

Land Transport Rule: Traffic Control Devices Amendment 2015

Land Transport Rule: Traffic Control Devices Amendment 2014

Land Transport Rule: Traffic Control Devices Amendment 2013

Land Transport Rule: Traffic Control Devices Amendment 2012

Land Transport Rule: Traffic Control Devices Amendment 2011

Land Transport Rule: Traffic Control Devices Amendment 2010

Land Transport Management Amendment Act 2008

Land Transport Rule: Traffic Control Devices Amendment 2007

Land Transport Rule: Traffic Control Devices Amendment 2006

Land Transport Rule: Traffic Control Devices Amendment 2005

Part 1

Rule requirements

Section 1 Application

1.1 Title

This rule is *Land Transport Rule: Traffic Control Devices 2004*.

1.2 Scope of the rule

This rule:

- (a) specifies requirements for the design, construction, installation, operation and maintenance of traffic control devices; and
- (b) sets out the functions and responsibilities of road controlling authorities in providing traffic control devices to give effect to their decisions on the control of traffic.

1.3 Objective of the rule

The objective of this rule is to contribute to a safe and efficient roading environment for all road users by ensuring that traffic is controlled by means of traffic control devices that are safe, appropriate, effective, uniform and consistently applied.

1.4 Date when rule comes into force

This rule comes into force on 27 February 2005.

1.5 Application of rule provisions

1.5(1) If there is a conflict between a provision of this rule and the corresponding provision of a document incorporated by reference in the rule, the provision of this rule applies.

1.5(2) If there is a conflict between a provision of this Rule and an example included in this Rule, the provision of this Rule applies.

Clause 1.5(2): inserted, on 30 August 2020, by clause 2.1(2) of Land Transport Rule: Traffic Control Devices Amendment 2020.

Section 2 Role of road controlling authorities

- 2.1(1) A road controlling authority must:
- (a) authorise and, as appropriate, install or operate traffic control devices:
 - (i) if required by or under this rule or other enactment; or
 - (ii) to instruct road users of a prohibition or requirement that it has made concerning traffic on a road under its control; or
 - (iii) to warn road users of a hazard; and
 - (b) remove a traffic control device if required by or under this rule or other enactment.
- 2.1(2) A road controlling authority may authorise and, as appropriate, install, operate or remove traffic control devices:
- (a) if desirable for the guidance of traffic or to draw attention to a requirement that controls traffic; or
 - (b) to provide information to road users.

Section 3 General requirements for traffic control devices

3.1 General safety requirements for traffic control devices

Traffic control devices, whether used singly or in combination, must contribute to the safe and effective control of traffic, and must:

- (a) be safe and appropriate for the road, its environment or the use of the road; and
- (b) not dazzle, distract or mislead road users; and
- (c) convey a clear and consistent message to road users; and
- (d) be placed so as to:
 - (i) be visible to road users; and
 - (ii) be legible to road users, if of a type that includes written words or symbols; and
 - (iii) allow adequate time for the intended response from road users; and
- (e) comply with the relevant requirements in *Schedules 1, 2 and 3*; and

- (f) be maintained in good repair.

3.2 Use of traffic control devices

- 3.2(1) A traffic control device that was authorised by or under any enactment, including this Rule, at the time it was manufactured or installed may continue to be used for the purpose for which it was intended, unless:
- (a) an expiry date for the use of the traffic control device is specified in this Rule; or
 - (b) a replacement traffic control device is required by this Rule to be installed by a specified time; or
 - (c) it is unsafe or inadequate for its intended use; or
 - (d) it is damaged or worn to an extent that it requires repair.
- 3.2(2) Except as provided in *4.2(6)*, *4.2(9)*, *4.4(14)*, *4.4(17)* and *11.7(1)(b)*, a person must not provide or operate a traffic control device on a road without first obtaining approval from the road controlling authority in control of that road.
- 3.2(3) The Agency may, at any time, by notice in writing to a road controlling authority, prohibit the installation, or require the modification or removal, of a traffic control device that does not comply with this rule, or that presents, or may present, a hazard to road safety.
- 3.2(4) The Agency may direct a road controlling authority to install any traffic control device that the Agency considers necessary in the interests of the safe or efficient use of a road.
- 3.2(5) A person must not install on a road, or in or on a place visible from a road, a sign, device or object that is not a traffic control device, but that:
- (a) may be mistaken for a traffic control device; or
 - (b) may prevent the traffic control device from complying with *3.1(a)* to *(d)*.
- 3.2(6) A person must not:
- (a) damage or otherwise interfere with a traffic control device in any way; or
 - (b) remove or obscure a traffic control device unless authorised by:
 - (i) a road controlling authority; or
 - (ii) the Agency under *13.8*; or

- (iii) a member of the New Zealand Police under 13.9.

Clause 3.2(1): amended, on 1 November 2014, by *clause 2.1* of *Land Transport Rule: Traffic Control Devices Amendment 2014*.

Clause 3.2(1): replaced, on 1 April 2011, by *clause 2.1* of *Land Transport Rule: Traffic Control Devices Amendment 2010*.

Clause 3.2(3): amended, on 1 August 2008, by *Part 2* of *Schedule 3* of the *Land Transport Management Amendment Act 2008*.

Clause 3.2(4): amended, on 1 August 2008, by *Part 2* of *Schedule 3* of the *Land Transport Management Amendment Act 2008*.

Clause 3.2(6)(b)(ii): amended, on 1 August 2008, by *Part 2* of *Schedule 3* of the *Land Transport Management Amendment Act 2008*.

3.3 **Matters to be taken into account when providing, modifying and removing traffic control devices**

A road controlling authority, in deciding whether to provide, modify or remove a traffic control device, must:

- (a) comply with:
 - (i) relevant requirements in *Schedules 1, 2* and *3*; and
 - (ii) a safety management system developed by the road controlling authority for that area; and
 - (iii) a direction given by the Agency under 13.8; and
- (b) ensure that the impact of providing, modifying or removing the traffic control device is consistent with the current regional land transport plan for that area.

Clause 3.3(a)(iii): amended, on 1 August 2008, by *Part 2* of *Schedule 3* of the *Land Transport Management Amendment Act 2008*.

Clause 3.3(b): amended, on 1 May 2021, by *clause 2.1* of *Land Transport Rule: Traffic Control Devices Amendment 2021*.

3.4 **Trials of traffic control devices**

3.4(1) The Agency may, from time to time, by notice in the *Gazette*, authorise a road controlling authority to install and maintain a traffic control device for trial purposes.

3.4(2) If the Agency declines to authorise a trial under 3.4(1), the Agency must advise the road controlling authority of the grounds for doing so.

3.4(3) Although it may not otherwise comply with this rule, a traffic control device in 3.4(1) must comply with:

- (a) *subclauses 3.1(a), (b), (c), (d)* and *(f)*; and

- (b) *subclause 3.1(e)*, except to the extent approved by the Agency for the purpose of the trial.
- 3.4(4) The Agency must state the following in the *Gazette* notice:
 - (a) the purpose of the trial; and
 - (b) the place where the trial is to be held; and
 - (c) the period, not exceeding two years, of the trial; and
 - (d) the terms and conditions of the trial; and
 - (e) any type of traffic control device in use under this rule that is equivalent to the traffic control device to be used in the trial.
- 3.4(5) The Agency may impose any other terms and conditions on the trial of a traffic control device that the Agency considers necessary.
- 3.4(6) Not less than two weeks before a trial traffic control device is installed, a road controlling authority must advertise separately in at least two editions of a local newspaper circulating in the district in which the trial is to be held, the placement of the traffic control device to be trialled and the purpose of the trial.
- 3.4(7) The Agency may terminate the trial of a traffic control device by notice in writing to the road controlling authority, stating the grounds for the decision to terminate the trial, if the Agency considers it is unsafe to continue the trial or the circumstances relating to the trial have changed or the conditions of the trial are not being complied with.
- 3.4(8) If a trial is terminated in accordance with 3.4(7), the Agency must notify the termination of the trial by notice in the *Gazette*.
- 3.4(9) A road controlling authority must remove a traffic control device installed under 3.4(1) immediately following the receipt of notice under 3.4(7).
- 3.4(10) If the Agency is satisfied that the results of a trial justify a recommendation that this rule be amended to allow all road controlling authorities to use the traffic control device, the traffic control device may continue in use, subject to any conditions that the Agency may impose, until either:
 - (a) the rule is amended, in which case the traffic control device may continue in use provided that it complies with the amended rule; or

- (b) a decision is made not to amend the rule and, on written notification of this decision, the road controlling authority must remove the traffic control device immediately.

3.4(11) If 3.4(10) applies, and subject to 3.4(10)(b), the Agency may authorise road controlling authorities to conduct further trials by installing and maintaining the traffic control device at other locations for a period of time, subject to any conditions, and must notify the further use of the traffic control device by notice in the *Gazette*.

Clause 3.4(1): amended, on 1 August 2008, by *Part 2 of Schedule 3 of the Land Transport Management Amendment Act 2008*.

Clause 3.4(2): amended, on 1 August 2008, by *Part 2 of Schedule 3 of the Land Transport Management Amendment Act 2008*.

Clause 3.4(3)(b): amended, on 1 August 2008, by *Part 2 of Schedule 3 of the Land Transport Management Amendment Act 2008*.

Clause 3.4(4): amended, on 1 August 2008, by *Part 2 of Schedule 3 of the Land Transport Management Amendment Act 2008*.

Clause 3.4(5): amended, on 1 August 2008, by *Part 2 of Schedule 3 of the Land Transport Management Amendment Act 2008*.

Clause 3.4(7): amended, on 1 August 2008, by *Part 2 of Schedule 3 of the Land Transport Management Amendment Act 2008*.

Clause 3.4(8): amended, on 1 August 2008, by *Part 2 of Schedule 3 of the Land Transport Management Amendment Act 2008*.

Clause 3.4(10): amended, on 1 August 2008, by *Part 2 of Schedule 3 of the Land Transport Management Amendment Act 2008*.

Clause 3.4(11): amended, on 1 August 2008, by *Part 2 of Schedule 3 of the Land Transport Management Amendment Act 2008*.

Clause 3.4(11): replaced, on 1 April 2011, by *clause 2.2 of Land Transport Rule: Traffic Control Devices Amendment 2010*.

Section 4 Traffic signs

4.1 Purposes of traffic signs

A traffic sign may be:

- (a) ‘regulatory’ (including speed limit and parking signs), that is, it instructs road users by requiring or prohibiting specified actions in using a road;
- (b) ‘warning’, that is, it informs road users of hazards or of other features requiring a safe response on or near a road;
- (c) ‘advisory’, that is, it provides road users with information or guidance (including information about destinations,

routes, amenities, distances, street name signs and place names).

4.2 Provision of traffic signs

Regulatory signs

- 4.2(1) A road controlling authority must provide a regulatory sign to instruct road users of the speed at which they may travel where a speed limit changes, and at intervals within the speed limit area, as specified in *section 9 of Land Transport Rule: Setting of Speed Limits 2017*.
- 4.2(2) A road controlling authority must install regulatory signs in accordance with 4.2(3) to draw attention to a requirement, restriction or prohibition on road users when:
- (a) the road controlling authority has made the requirement, restriction or prohibition by bylaw (or other instrument) on a road under its control; or
 - (b) this rule or any other enactment requires the installation of a regulatory sign to draw attention to the requirement, restriction or prohibition; or
 - (c) this rule or any other enactment does not require the installation of a regulatory sign, but the road controlling authority considers it desirable that a sign be installed.
- 4.2(3) Unless specified elsewhere in this Rule, regulatory signs must be installed to instruct road users of a requirement, restriction or prohibition on traffic:
- (a) at each point where the requirement, restriction or prohibition applies; or
 - (b) where the requirement, restriction or prohibition applies to a length of road:
 - (i) at the start; and
 - (ii) after each intersection along its length; and
 - (iii) at the end; and
 - (iv) at intervals along its length, as specified in this rule or other enactment; or
 - (c) where the requirement, restriction or prohibition applies to a zone restriction at:
 - (i) each entry point to the zone; and

- (ii) intervals within the zone, as specified in this rule; and
- (iii) each exit point from the zone.

Permanent warning signs

- 4.2(4) A road controlling authority must install a permanent warning sign at any place where it considers special care or reduced speed is appropriate, and, in particular, must consider its appropriateness near the entrance to a school, kindergarten, pre-school centre or hospital.

Temporary warning signs

- 4.2(5) A road controlling authority must install temporary warning signs if it considers there is, or is likely to arise, at any place on a road, a temporary risk of:

- (a) danger to the public or to road workers; or
- (b) damage to the road.

- 4.2(6) For a temporary hazard, such as a disabled vehicle on the road, an accident, a slip, a washout or a broken transmission line, an appropriate temporary warning sign may be erected by:

- (a) emergency services personnel; or
- (b) a worker involved in removing the temporary hazard, or in making the hazard area safe.

- 4.2(7) A temporary sign under 4.2(5) and 4.2(6) must be removed as soon as the need for it has ended.

- 4.2(8) Despite 4.2(7), the Agency or a member of the New Zealand Police may, at any time, direct that a temporary warning sign be removed or additional signs be installed.

- 4.2(9) Any person may erect a 'warning' triangle sign on a roadway to inform approaching road users of an accident or a broken-down vehicle.

Advisory signs

- 4.2(10) A road controlling authority must install and maintain signs, as it considers necessary or desirable, to inform road users of destinations, routes, street names, distances, the names of localities or other information of value to road users.

Clause 4.2(1): amended, on 1 June 2019, by clause 2.1 of Land Transport Rule: Traffic Control Devices Amendment 2019.

Clause 4.2(3): amended, on 1 April 2011, by clause 2.3 of Land Transport Rule: Traffic Control Devices Amendment 2010.

Clause 4.2(8): amended, on 1 August 2008, by Part 2 of Schedule 3 of the Land Transport Management Amendment Act 2008.

4.3 Types of traffic sign

- 4.3(1) A traffic sign that displays appropriate regulatory, warning or advisory messages for road users may be either:
- (a) a 'permanent' sign; or
 - (b) a 'temporary' sign installed for a temporary hazard on a road, or a temporary risk of danger to road users or of damage to the road.
- 4.3(2) A 'variable' traffic sign, which is capable of displaying a different message to meet traffic management needs at different times, may be either a permanent or a temporary sign.

4.4 General requirements for traffic signs

Description of traffic signs

- 4.4(1) Subject to 4.4(2), a traffic sign, and the details on the sign, must comply with the minimum dimensions specified in *Schedule 1*.
- 4.4(2) The dimensions of a traffic sign may be increased provided that the dimensions of each letter, numeral, symbol or other detail on the sign are kept in approximate proportion to the dimensions of the other details on the sign.
- 4.4(3) Except as provided in 4.4(4) and 4.4(5), a traffic sign may display only words or symbols that are allowed by this rule.
- 4.4(4) Despite 4.4(1), 4.4(2), and 4.4(3), the Agency may, by notice in the *Gazette*, authorise the installation and maintenance of a traffic sign that does not comply with the colour, shape, dimensions, words, numerals, symbols, number of elements, background, border, or legend specified in *Schedule 1*.
- 4.4(5) A traffic sign, other than a regulatory sign, may display one monogram or one logo:
- (a) for a street name sign, to identify the road controlling authority or locality within a road controlling authority's area, or to mark the historical significance of the street name, provided that the monogram or logo does not detract from the legibility of the street name sign;
 - (b) for a sign other than one in (a), provided that:
 - (i) on a sign less than 1 m² in area, the monogram or logo is not larger than 30 cm²;

- (ii) on a sign 1 m² or greater in area, the monogram or logo is not larger than 100 cm²;
- (c) for a temporary warning sign, other than a supplementary temporary warning sign, initials or other identifying marks may be marked by means of a series of perforations provided that these do not affect the ability of the sign to perform safely and adequately for its intended use.

[Note: Temporary warning signs are within the series W1 to W7 in *Schedule 1*.]

- 4.4(6) A traffic sign may not display on the reverse side written material or a monogram, except:
- (a) another traffic sign as provided in 4.5(1); or
 - (b) a non-reflective sticker, label or other device no more than 100 cm², which may contain:
 - (i) details of the ownership of the sign; or
 - (ii) information that uniquely identifies the sign; or
 - (iii) details of manufacture, installation or maintenance;
 - (c) a sign complying with 4.4(5)(c).
- 4.4(7) If this rule requires a traffic sign or part of a traffic sign to be reflectorised, it must be:
- (a) reflectorised by the use of reflective material that is approved by the Agency by notice in the *Gazette*; or
 - (b) internally or externally illuminated so as to be visible when illuminated.
- 4.4(8) A traffic sign, or a letter, numeral, border or symbol displayed on a traffic sign, must be of a type and of the appropriate colour specified in *Schedule 1*.
- Installation of traffic signs*
- 4.4(9) A road controlling authority must install a traffic sign on the left-hand side of the road from the point of view of a person approaching the sign, except if a different position:
- (a) would be safer and more effective in the circumstances; or
 - (b) is specified in any enactment.
- 4.4(10) If a traffic sign has been installed on the left-hand side of the road, a sign conveying the same message may also be installed on the right-hand side of the road, on a traffic island or on a median.

Support for traffic signs

- 4.4(11) Written material (other than a supplementary notice relating to a passenger service) or a monogram must not be displayed on a pole on which a road controlling authority has installed a traffic sign.
- 4.4(12) The colour and form of a pole that is used to support a traffic sign specified in 6.3(4), 6.3(5), 8.2(9) and 9.4(3) may be used only for the purpose specified in those provisions.

Vehicle-mounted signs

- 4.4(13) A traffic sign must not be displayed on a vehicle unless:
- (a) allowed under 4.4(14) or 4.4(17) to 4.4(19), or under another enactment; or
 - (b) the display complies with *Schedule 1*.
- 4.4(14) A motor vehicle that is being used as a school bus must display on the outside of the vehicle a 'School Bus' sign, as specified in *Schedule 1*, at both the front and the rear.
- 4.4(15) A sign in 4.4(14) must be mounted:
- (a) at the rear, with its lower edge not less than 1.5 m from the ground in the centre-line, or to the right of the centre-line, of the school bus when it is facing forward;
 - (b) at the front, so as to be visible to road users approaching the vehicle from the front and on the opposite side of the roadway.
- 4.4(15A) When a vehicle in 4.4(14) displays a "School Bus" sign which incorporates flashing lights (sign W17-1.3, *Schedule 1*) the flashing lights must not be operated:
- (a) more than 20 seconds before the bus stops for the purpose of children alighting or boarding; or
 - (b) more than 20 seconds after the bus has moved away from the place at which it stopped.
- 4.4(16) When a vehicle in 4.4(14) is not being used as a school bus, the 'School Bus' sign must not be displayed.
- 4.4(17) A motor vehicle that is required under *Land Transport Rule: Vehicle Dimensions and Mass 2002* to display a vehicle-mounted sign must comply with the relevant provisions in that rule relating to vehicle-mounted signs.
- 4.4(18) An appropriate warning sign may be installed on a motor vehicle:

- (a) engaged in road maintenance or other work while moving along the road; or
 - (b) being used to inform other road users of the presence of a moving hazard including a vehicle in (a), stock or people in a parade or event.
- 4.4(19) A variable traffic sign that provides a range of information to motorists and that complies with 4.6 may be mounted on a motor vehicle if:
- (a) the vehicle remains stationary in a safe position on the roadside; or
 - (b) the vehicle is involved in temporary traffic management and operates in accordance with a traffic management plan and the message displayed remains the same while the vehicle is in motion.
- 4.4(20) The information that may be provided by a variable traffic sign in 4.4(19) includes:
- (a) traffic and road conditions applying and advice on actions motorists might take as a result; or
 - (b) future activity on or near the road that will affect motorists using that road in terms of route choice or travel delays.
- 4.4(21) When a motor vehicle is not being used for any of the purposes described in 4.4(18) or 4.4(19) the sign must not be displayed.
- Clause 4.4(4): amended, on 1 August 2008, by Part 2 of Schedule 3 of the Land Transport Management Amendment Act 2008.*
- Clause 4.4(4): amended, on 1 April 2011, by clause 2.4(1) of Land Transport Rule: Traffic Control Devices Amendment 2010.*
- Clause 4.4(4): amended, on 1 December 2016, by clause 2.1 of Land Transport Rule: Traffic Control Devices Amendment 2016.*
- Clause 4.4(5)(a): amended, on 1 November 2014, by clause 2.2 of Land Transport Rule: Traffic Control Devices Amendment 2014.*
- Clause 4.4(5)(c): inserted, on 1 April 2011, by clause 2.4(2) of Land Transport Rule: Traffic Control Devices Amendment 2010.*
- Note after clause 4.4(5)(c): inserted, on 1 April 2011, by clause 2.4(2) of Land Transport Rule: Traffic Control Devices Amendment 2010.*
- Clause 4.4(6)(c): inserted, on 1 April 2011, by clause 2.4(3) of Land Transport Rule: Traffic Control Devices Amendment 2010.*
- Clause 4.4(7)(a): amended, on 1 August 2008, by Part 2 of Schedule 3 of the Land Transport Management Amendment Act 2008.*
- Clause 4.4(15A): inserted, on 1 April 2011, by clause 2.4(4) of Land Transport Rule: Traffic Control Devices Amendment 2010.*

Clause 4.4(16): amended, on 6 October 2006, by *clause 2.1* of *Land Transport Rule: Traffic Control Devices Amendment 2006*.

Clause 4.4(19): replaced, on 1 April 2011, by *clause 2.4(5)* of *Land Transport Rule: Traffic Control Devices Amendment 2010*.

4.5 Specific requirements for traffic signs

Combining signs

4.5(1) A traffic sign must not be installed with another sign on the same pole or in the same location on the same building, wall or fence, except:

- (a) as provided in 9.4(7), 9.4(8), 10.5(2), 11.4(3), 12.5(6); or
- (b) if:
 - (i) each sign is installed so that its message is seen only by traffic for which the message is intended; and
 - (ii) the shape, size or orientation of any sign does not obscure the sign, or mislead or distract road users from the sign intended to be seen by traffic moving in another direction; or
- (c) if the additional sign is a supplementary sign, plate or notice.

Signs on traffic signals or pedestrian poles

4.5(2) A traffic sign must not be installed on:

- (a) a pole supporting a traffic signal, except as provided in 9.4(8) or 10.5(2); or
- (b) a black and white pole installed at a pedestrian crossing, except for:
 - (i) a school patrol stop sign;
 - (ii) the traffic control device required in 8.2(10).

Clause 4.5(1)(a): amended, on 1 January 2014, by *clause 2.1(1)* of *Land Transport Rule: Traffic Control Devices Amendment 2013*.

Clause 4.5(1)(a): amended, on 1 April 2011, by *clause 2.5(1)* of *Land Transport Rule: Traffic Control Devices Amendment 2010*.

Clause 4.5(1)(c): inserted, on 1 April 2011, by *clause 2.5(2)* of *Land Transport Rule: Traffic Control Devices Amendment 2010*.

Clause 4.5(2)(b): amended, on 1 January 2014, by *clause 2.1(2)* of *Land Transport Rule: Traffic Control Devices Amendment 2013*.

Clause 4.5(2)(b): amended, on 15 September 2005, by *clause 2.1* of *Land Transport Rule: Traffic Control Devices Amendment 2005*.

4.6 Variable traffic signs

A variable traffic sign must:

- (a) in changing from one traffic sign to another, conform to a protocol approved by the road controlling authority; and
- (b) display only traffic signs that comply with *Schedule 1* and that are approved by the road controlling authority.

4.7 Advertising signs

A sign, hoarding or similar structure used or intended to be used for the purposes of advertising must not contain:

- (a) reflective material, if it is likely to reflect the light from the lamps of any vehicle on the road; or
- (b) fluorescent or phosphorescent material, if it is likely to mislead or distract drivers from traffic signs installed in the vicinity or mask those signs.

Section 5 Markings

5.1 Purposes of markings

A marking (other than roadway art installed in accordance with 5.6(1)) has one of the following functions:

- (a) ‘regulatory’, that is, it instructs road users by requiring or prohibiting specified actions in using a road;
- (b) ‘warning’, that is, it informs road users of permanent hazards on a roadway or gives advance notice of features on or near a road;
- (c) ‘advisory’, that is, it provides road users with information or guidance in the intended use of the road.

Clause 5.1: amended, on 30 August 2020, by clause 2.2(1) of Land Transport Rule: Traffic Control Devices Amendment 2020.

5.2 Provision of markings

5.2(1) A road controlling authority must, except if the road surface makes this impracticable, provide markings if required to do so by this rule or any other enactment.

5.2(2) When providing markings for any of the purposes in 5.1 or when installing roadway art in accordance with 5.6(1), a road controlling authority must comply with this rule.

5.2(3) A road controlling authority may provide regulatory, warning, or advisory markings on a road under its control if necessary or

desirable for the guidance of traffic or to draw attention to a requirement that controls traffic.

Clause 5.2(2): amended, on 30 August 2020, by *clause 2.3(1)* of *Land Transport Rule: Traffic Control Devices Amendment 2020*.

Clause 5.2(3): amended, on 1 November 2015, by *clause 2.1* of *Land Transport Rule: Traffic Control Devices Amendment 2015*.

5.3 Method of marking

A marking may consist of:

- (a) for any marking: paint, material resembling paint, or non-reflectorised, reflectorised or illuminated pavement markers; or
- (b) for a marking that may supplement, but not replace, a regulatory marking or sign, or for roadway art installed in accordance with 5.6(1): contrasting surface texture or colour defining an area of road that is used for a specific purpose.

Clause 5.3(a): amended, on 30 August 2020, by *clause 2.4(1)* of *Land Transport Rule: Traffic Control Devices Amendment 2020*.

Clause 5.3(b): amended, on 30 August 2020, by *clause 2.4(2)* of *Land Transport Rule: Traffic Control Devices Amendment 2020*.

5.4 General requirements for markings

Description of markings

- 5.4(1) A marking, whether or not required under this rule, must comply with the relevant specifications in *Schedule 2*.
- 5.4(1A) Despite 5.4(1) and 5.4(2), the Agency may, by notice in the *Gazette*, authorise the installation and maintenance of a marking that does not comply with the colour, shape, dimensions, letters, words, numerals, or symbols specified in *Schedule 2*.
- 5.4(2) Subject to 5.4(2A) and 5.4(3), a marking must comply with the minimum dimensions specified in *Schedule 2*.
- 5.4(2A) The dimensions of markings intended solely for pedestrians or cyclists may be decreased provided that the dimensions of each letter, numeral or symbol are decreased in approximately the same proportion.
- 5.4(3) Subject to 5.4(3A), the dimensions of a marking may be increased provided that, from the viewpoint of a driver approaching the mark, the lateral dimensions of each letter, numeral, symbol or other detail displayed on the marking are

retained and all longitudinal dimensions are increased in the same proportion.

- 5.4(3A) The dimensions of the marks M3-1, M3-2 and M3-3, specified in *Schedule 2*, must not be increased.
- 5.4(4) If this rule requires a marking to be reflectorised, it must be:
- (a) reflectorised by the use of reflective material; or
 - (b) internally illuminated so as to be visible when illuminated.
- 5.4(5) A letter or numeral displayed by a marking must be of a type specified in *Schedule 2*.
- 5.4(6) A pavement marker that is applied or attached permanently to the roadway must be white or yellow, except if it is a marker that is:
- (a) blue and is installed on, or just to the left of, the centre-line of the roadway and is—
 - (i) a non-flashing pavement marker used only to mark the presence of a fire hydrant or other water source used for firefighting; or
 - (ii) a flashing, illuminated pavement marker used to indicate that the road may be slippery due to frost, ice, or snow; or
 - (b) red and is installed only on the left-hand side of the roadway to mark the edge of the safe, useable portion of the roadway; or
 - (c) green and is installed on, or just to the left of, the centre-line of the roadway and is used only to mark the presence of a culvert or other drain under the roadway.
- 5.4(7) A raised pavement marker that was installed before the commencement of this rule that does not comply with 5.4(6) must be removed by 30 June 2009.
- 5.4(8) A blue surface texture or colour may only be used for reserved parking areas that are restricted to use by disabled persons in accordance with 12.4(6).

Clause 5.4(1A): inserted, on 1 December 2016, by *clause 2.2(1)* of *Land Transport Rule: Traffic Control Devices Amendment 2016*.

Clause 5.4(2): amended, on 1 November 2014, by *clause 2.3(1)* of *Land Transport Rule: Traffic Control Devices Amendment 2014*.

Clause 5.4(2A): inserted, on 1 November 2014, by *clause 2.3(2)* of *Land Transport Rule: Traffic Control Devices Amendment 2014*.

Clause 5.4(3): replaced, on 1 April 2011, by clause 2.6(1) of Land Transport Rule: Traffic Control Devices Amendment 2010.

Clause 5.4(3A): inserted, on 1 April 2011, by clause 2.6(1) of Land Transport Rule: Traffic Control Devices Amendment 2010.

Clause 5.4(6): amended, on 1 December 2016, by clause 2.2(2) of Land Transport Rule: Traffic Control Devices Amendment 2016.

Clause 5.4(6)(a): replaced, on 1 December 2016, by clause 2.2(3) of Land Transport Rule: Traffic Control Devices Amendment 2016.

Clause 5.4(8): inserted, on 1 April 2011, by clause 2.6(2) of Land Transport Rule: Traffic Control Devices Amendment 2010.

5.5 **Markings intended for advertising purposes or not connected with use of a road**

A person must not install, on a roadway, a marking that is intended to be used for the purpose of advertising or other purpose not connected with the use of the road unless it is roadway art installed in accordance with 5.6(1).

Heading to clause 5.5: amended, on 30 August 2020, by clause 2.5(1) of Land Transport Rule: Traffic Control Devices Amendment 2020

Clause 5.5: amended, on 30 August 2020, by clause 2.5(2) of Land Transport Rule: Traffic Control Devices Amendment 2020.

5.6 **Requirements for roadway art**

5.6(1) Despite anything in 5.4, a road controlling authority may install any marking on a roadway (**roadway art**) if the roadway art:

- (a) is installed in a lower risk environment; and
- (b) does not resemble and is not similar to a marking described in this Rule; and
- (c) does not mislead road users about the meaning of any traffic control device; and
- (d) is not part of or visually integrated into a marking specified in *Schedule 2*.

5.6(2) In this Rule, **lower risk environment** means an area—

- (a) where the road controlling authority manages speeds, through the use of any combination of traffic control devices, roadside developments, roadway art and other changes in the road environment, with the aim to achieve an outcome where the operating speed of vehicles (except in emergency situations) is not more than 30km/h (whether or not the speed limit for the area is 30km/h); and

- (b) in relation to which it is reasonable for the road controlling authority to believe that outcome has been or will be achieved.

Example 1:

On a wide urban street with a 50km/h speed limit and that has a wide-angle intersection with another street, a road controlling authority has narrowed the roadway by installing planter boxes and removing car parks. It also paints an assortment of coloured circles on the roadway. The shapes do not resemble and are not similar to any markings described in this Rule, and are also not part of or visually integrated into any markings specified in *Schedule 2*.

Those measures will achieve an outcome where the operating speed of vehicles (except in emergency situations) is not more than 30km/h. The relevant area is a lower risk environment.

These painted circles are roadway art installed in accordance with *5.6(1)*.

Example 2:

A series of long rectangles are painted on the road, parallel to the kerb and perpendicular to oncoming vehicle traffic. These either resemble or are similar to markings for a pedestrian crossing, which are described in this Rule (see M1-1 in *Schedule 2*), so cannot be installed as roadway art under *5.6(1)*.

Example 3:

On a wide urban street that has a wide-angle intersection with another street, a road controlling authority has installed a sign advising to slow for pedestrians, with the aim of achieving an outcome where the operating speed of vehicles (except in emergency situations) is not more than 30km/h. However, it can be regularly observed that vehicles travel through the area at more than 30km/h. It is not reasonable to believe the outcome has been or will be achieved if nothing more is done. The relevant area is not a lower risk environment. Accordingly, roadway art cannot be installed in the area.

Clause 5.6: inserted, on 30 August 2020, by clause 2.6 of Land Transport Rule: Traffic Control Devices Amendment 2020.

5.7 Powers of Agency over markings

- 5.7(1) The Agency may, by notice in writing, require a road controlling authority to remove any marking from a roadway if one or more of the following applies:
- (a) the marking is a traffic control device, or the road controlling authority or the Agency considers the marking is a traffic control device, and the Agency considers on reasonable grounds that the marking does not comply with *Section 3*, clause 5.3, or clause 5.4:
 - (b) the marking is roadway art for the purposes of 5.6(1), or the road controlling authority or the Agency considers the marking is roadway art for the purposes of 5.6(1), and the Agency considers on reasonable grounds that the marking does not comply with 5.3 or has not been installed in accordance with 5.6(1):
 - (c) the Agency considers on reasonable grounds that the marking has been installed in breach of 5.5.
- 5.7(2) A notice in 5.7(1) must:
- (a) specify the marking or markings to be removed; and
 - (b) include the grounds on which the Agency requires the marking to be removed; and
 - (c) include a deadline for removal, which must be no earlier than 5 working days after the date the notice is given.
- 5.7(3) A road controlling authority that is given a notice under 5.7(1) must remove the marking or markings stated in the notice before the deadline stated in the notice.
- 5.7(4) If after the deadline stated in the notice the marking or markings have not been fully removed, the Agency may:
- (a) remove the marking or markings; and
 - (b) install markings that are traffic control devices that comply with this Rule.
- 5.7(5) Without limiting the Agency's powers under this clause, the Agency can also exercise its powers under 3.2(3) or 13.8(1) in respect of a marking that is roadway art for the purposes of 5.6(1) as if the marking were a traffic control device for the purposes of 3.2(3) or 13.8(1).

Clause 5.7: inserted, on 30 August 2020, by clause 2.6 of Land Transport Rule: Traffic Control Devices Amendment 2020.

5.8 Powers of Agency over lower risk environments

- 5.8(1) This clause applies to a marking that is roadway art for the purposes of 5.6(1), or that the road controlling authority or the Agency considers is roadway art for the purposes of 5.6(1) (**the relevant marking**).
- 5.8(2) If the Agency considers on reasonable grounds that the roadway on which the relevant marking has been installed is not a lower risk environment, the Agency may, by notice in writing, require a road controlling authority to install or remove traffic control devices or roadside developments or make other changes in the road environment (**take action**), with the aim of making the roadway a lower risk environment.
- 5.8(3) A notice in 5.8(2) must:
- (a) specify the action to be taken, including by specifying the outcome to be achieved from the action (for example, a roadway of a certain maximum width); and
 - (b) include the grounds on which the Agency requires that action to be taken; and
 - (c) include a deadline for that action to be taken, which must be no earlier than 5 working days after the date the notice is given.
- 5.8(4) A road controlling authority that is given a notice under 5.8(2) must take the action stated in the notice before the deadline stated in the notice.
- 5.8(5) If after the deadline stated in the notice the action has not been fully taken, the Agency may take the action or remaining action.
- 5.8(6) The Agency may issue a notice under this clause whether or not the Agency also issues a notice under 5.7(1) in respect of the relevant marking or exercise its powers under 3.2(3) or 13.8(1) in respect of the relevant marking.

Clause 5.8: inserted, on 30 August 2020, by clause 2.6 of Land Transport Rule: Traffic Control Devices Amendment 2020.

5.9 Road controlling authority may appeal a notice from Agency

- 5.9(1) A road controlling authority that receives a notice under 5.7(1) or a notice under 5.8(2) may appeal against that decision under section 106 of the Act.

Clause 5.9: inserted, on 30 August 2020, by clause 2.6 of Land Transport Rule: Traffic Control Devices Amendment 2020.

Section 6 Traffic signals

6.1 Types and purposes of traffic signals

Traffic signals must be one of the following types:

- (a) steady vehicle displays that when operational:
 - (i) provide continuous control of the movement of vehicles; or
 - (ii) are roundabout metering signals for the purposes described in 6.4(13); or
 - (iii) are ramp signals for the purpose described in 6.4(16); or
 - (iv) are temporary traffic signals for the purposes described in 6.4(21); or
- (b) when the circumstances warrant, flashing vehicle displays that, when operational, control the movement of vehicles or warn drivers that they must be prepared to stop; or
- (c) pedestrian displays that, when operational, control the movement of pedestrians.

Clause 6.1(a)(ii): amended, on 1 April 2011, by clause 2.7 of Land Transport Rule: Traffic Control Devices Amendment 2010.

6.2 Provision of traffic signals

6.2(1) At an area controlled by traffic signals, a road controlling authority must install markings and traffic signals as described in 6.2(1A) for:

- (a) each roadway approach to the area controlled; and
- (b) any driveway approach to the area controlled where the road controlling authority considers this necessary for the safe or efficient operation of the area controlled.

6.2(1A) For each approach, defined in 6.2(1), to the area controlled by traffic signals, the road controlling authority must install:

- (a) if practicable, a limit line in accordance with 6.3(3) to define the place where vehicles are required to stop in advance of the area controlled; and
- (b) a traffic signal in a position that is visible to road users approaching the area controlled either:
 - (i) adjacent to, and as close as practicable to the end of, the limit line where marked; or

- (ii) where there is no limit line, at the point of entry to the area controlled; and
 - (c) except for temporary traffic signals and flashing red traffic signals, at least one supplementary steady traffic signal in a position that is visible to road users stopped:
 - (i) at the limit line where marked; or
 - (ii) where there is no limit line, at the point of entry to the area controlled.
- 6.2(1B) On multilane approaches to an area controlled by traffic signals, a road controlling authority may comply with 6.2(1A)(b) and (c) by installing traffic signals that apply to individual lanes or that apply to a combination of lanes forming part of that approach.
- 6.2(2) The road controlling authority may install additional signals to allow the controlled area to be used safely and efficiently.
- Clause 6.2(1):* replaced, on 1 April 2011, by *clause 2.8 of Land Transport Rule: Traffic Control Devices Amendment 2010.*
- Clause 6.2(1A):* inserted, on 1 April 2011, by *clause 2.8 of Land Transport Rule: Traffic Control Devices Amendment 2010.*
- Clause 6.2(1A)(c):* amended, on 1 December 2016, by *clause 2.3 of Land Transport Rule: Traffic Control Devices Amendment 2016.*
- Clause 6.2(1B):* inserted, on 1 April 2011, by *clause 2.8 of Land Transport Rule: Traffic Control Devices Amendment 2010.*

6.3 General requirements for traffic signals

Description of traffic signals

- 6.3(1) Traffic signal displays must comply with:
- (a) *Schedule 3* for:
 - (i) shape, symbols and letters; and
 - (ii) size of display; and
 - (b) *AS/NZS2144:2002 Traffic signal lanterns* for brightness and colour, when existing lanterns are upgraded or replaced.

Signs at traffic signals

- 6.3(2) Except as provided in 6.4(15)(d), 9.4(8) or 10.5(2), a road controlling authority must not install a traffic sign on a pole that supports a traffic signal.

Markings at traffic signals

- 6.3(3) Where an area of road is controlled by traffic signals, unless the road surface makes it impracticable, a road controlling authority must mark, in accordance with *section 5*, the following on a roadway under its control:
- (a) a limit line, at the point of entry to an area controlled by traffic signals for each lane approaching the area, in the form of a white transverse line that:
 - (i) for a cycle lane, or a cycle storage area in advance of a cycle lane, is at least 100 mm wide; or
 - (ii) for every other lane, is at least 300 mm wide;
 - (b) white lines at least 100 mm wide to guide pedestrians at pedestrian traffic signals, in accordance with 8.5.

Mounting of signals

- 6.3(4) A steady traffic signal display, other than a temporary traffic signal or a pedestrian display, must be mounted on:
- (a) an unpainted pole or structure; or
 - (b) a yellow or grey painted pole.
- 6.3(5) A temporary traffic signal must be mounted on a yellow painted pole or stand and the top of the signal display must be not less than 2.5 m nor more than 4 m from the surface of the road.
- 6.3(6) If a traffic signal is a flashing red vehicle display:
- (a) of a type in 6.5(11), the traffic signal must be mounted on a pole that has alternate reflectorised red and white bands that are at least 225 mm wide; or
 - (b) of a type in 6.5(13), the traffic signal may be mounted on a pole that has alternate reflectorised red and white bands that are at least 225 mm wide.

Clause 6.3(1)(b): amended, on 1 April 2011, by *clause 2.9(a)* of *Land Transport Rule: Traffic Control Devices Amendment 2010*.

Clause 6.3(2): amended, on 1 April 2011, by *clause 2.9(b)* of *Land Transport Rule: Traffic Control Devices Amendment 2010*.

Clause 6.3(3)(b): amended, on 1 June 2019, by *clause 2.2* of *Land Transport Rule: Traffic Control Devices Amendment 2019*.

Clause 6.3(6): amended, on 1 April 2011, by *clause 2.9(c)* of *Land Transport Rule: Traffic Control Devices Amendment 2010*.

- 6.4 Steady vehicle displays in the form of a continuous display**
- 6.4(1) The configuration and combination of a steady vehicle display must comply with one of the displays in *Schedule 3*.
- 6.4(2) A steady vehicle display of a green, yellow or red disc signal applies to all traffic facing those signals, but may be overridden:
- (a) for a red disc display, by:
 - (i) a green or yellow arrow signal for traffic intending to travel in the direction indicated by the arrow;
 - (ii) a white B signal for buses, a white T signal for light-rail vehicles or a green cycle signal for cycles;
 - (iii) a yellow B signal for buses, a yellow T signal for light-rail vehicles or a yellow cycle signal for cycles;
 - (b) for a yellow disc display, by:
 - (i) a red or green arrow signal for traffic intending to travel in the direction indicated by the arrow;
 - (ii) a red B signal for buses, a red T signal for light-rail vehicles or a red cycle signal for cycles;
 - (c) for a green disc display, by:
 - (i) a red or yellow arrow signal for traffic intending to travel in the direction indicated by the arrow;
 - (ii) a red B signal for buses, a red T signal for light-rail vehicles or a red cycle signal for cycles.
- 6.4(2A) A steady vehicle display of a red arrow applies to all traffic intending to travel in the direction indicated by the arrow and is not overridden by a white or yellow B signal for buses, a white or yellow T signal for light-rail vehicles or a green or yellow cycle signal for cycles.
- Sequence of steady vehicle displays*
- 6.4(3) A steady vehicle display must operate in the following sequence, as appropriate:
- (a) a green disc signal followed by a yellow disc signal in the same column;
 - (b) a yellow disc signal followed by a red disc signal in the same column;
 - (c) a red disc signal followed by:
 - (i) a green disc signal or green arrow signal in the same column; or

- (ii) a green arrow signal in an adjacent column;
- (d) a green arrow signal followed by:
 - (i) a yellow disc signal or yellow arrow signal; or
 - (ii) in the case of a left turn green arrow signal, a green disc signal in an adjacent column provided that a signal phase for pedestrians that conflicts with the left-turning traffic does not commence when the left-turn green arrow signal changes to a green disc signal.
- (e) a yellow arrow signal followed by a red arrow signal in the same column, or if there is no red arrow signal in the same column, by a red disc signal or green disc signal in an adjacent column;
- (f) a red arrow signal followed by a green arrow signal in the same column, or if there is no green arrow signal in the same column, by a green disc signal in an adjacent column;
- (g) a green cycle signal, or a white B or white T signal followed by a yellow cycle, or a yellow B or yellow T signal in the same column or a green disc signal or green arrow signal in an adjacent column;
- (h) a yellow cycle, or a yellow B or yellow T signal followed by a red cycle, or a red B or red T signal in the same column or a red disc signal or red arrow signal in an adjacent column.

Operation of steady vehicle displays

- 6.4(4) In a single or multi-column steady vehicle display, other than for a roundabout signal or ramp signal display, at least one of the signals must be lit.
- 6.4(5) Two signals must not be displayed simultaneously in the same column, unless:
 - (a) both are green arrow signals; or
 - (b) one is a green disc signal and the other is a green arrow signal.
- 6.4(6) Traffic signals must operate so that vehicular traffic entering a controlled area in compliance with the signals from different approaches does not conflict, except for:

- (a) right-turning vehicular traffic against straight-through vehicular traffic from the opposite direction; or
 - (b) right-turning vehicular traffic against left-turning vehicular traffic from the opposite direction; or
 - (c) turning vehicular traffic against pedestrian traffic travelling in compliance with the traffic signal displays.
- 6.4(7) *Paragraph 6.4(6)(c)* does not apply if a green arrow signal is displayed and if vehicular traffic can proceed in the direction indicated by the arrow without having to give way to vehicular traffic and pedestrians that are allowed to proceed at the same time.
- 6.4(8) When vehicular traffic in different lanes approaching an area controlled by traffic signals is allowed to move in different directions at different times, multi-column traffic signals mounted side-by-side must be used to control the movement of vehicular traffic in the different lanes.
- 6.4(9) A steady yellow disc signal must be displayed for at least three seconds.
- Displays for special classes of vehicle*
- 6.4(10) If a bus lane traverses an area controlled by traffic signals, the road controlling authority:
- (a) must include a white B signal and may include a yellow B signal in the display of traffic signals to indicate when a bus is permitted to turn, or proceed straight ahead from the bus lane, when other vehicles are not allowed to make these movements; or
 - (b) must include a red B signal in the display of traffic signals to indicate when a bus may not proceed from the bus lane when other vehicles are allowed to move in the same general direction; or
 - (c) may include a column of white, yellow and red B signals in the display of traffic signals.
- 6.4(11) If a light-rail vehicle track traverses an area controlled by traffic signals, the road controlling authority:
- (a) must include a white T signal and may include a yellow T signal in the display of traffic signals to indicate when a light-rail vehicle is allowed to turn, or proceed straight ahead, when other vehicles are not allowed to make these movements; or

- (b) must include a red T signal in the display of traffic signals to indicate when a light-rail vehicle may not proceed along the light-rail vehicle track when other vehicles are allowed to move in the same general direction; or
 - (c) may include a column of white, yellow and red T signals in the display of traffic signals.
- 6.4(12) If a cycle lane traverses an area controlled by traffic signals, the road controlling authority:
- (a) must include a green cycle signal and may include a yellow cycle symbol in the display of traffic signals if cycles are allowed to enter an area controlled by signals when other traffic is not allowed to enter that area; or
 - (b) must include a red cycle signal in the display of traffic signals to indicate when a cycle is not allowed to proceed along the cycle lane when other vehicles are allowed to move in the same general direction; or
 - (c) may include a green, yellow and red cycle signal in the display of traffic signals.

Roundabout metering signals

- 6.4(13) Roundabout metering signals, with displays complying with one of the displays in *Schedule 3*, may be used to control the traffic from one or more of the approaches to a roundabout, if:
- (a) excessive queuing and delays are experienced on one or more approaches to the roundabout; or
 - (b) it is necessary to clear one of the approaches of a roundabout to allow a rail vehicle or an emergency vehicle to proceed safely; or
 - (c) it is necessary in order to increase the efficiency or safety of public transport services.
- 6.4(14) The area controlled by a roundabout metering signal must be at least 30 m in advance of, and control the movement of traffic approaching, the roundabout.
- 6.4(14A) The ‘give-way roundabout’ sign installed on an approach to a roundabout controlled by roundabout metering signals must comply with *10.4(1)(b)*.
- 6.4(15) A roundabout metering signal may be used as a mid-block pedestrian traffic signal if the following conditions are met:

- (a) the road on which the signal is installed must have a median island at the crossing point;
- (b) the pedestrian crossing must be staggered so that pedestrians must cross the road in two stages by being required to turn and travel along the median to reach the second half of the crossing;
- (c) each stage of the pedestrian crossing must operate independently;
- (d) a traffic sign directed toward traffic approaching the roundabout must be mounted on the signal pole or poles indicating that the signals may operate by roundabout demand.

Ramp signals

- 6.4(16) When traffic entering a motorway is to be controlled to prevent the breakdown of traffic flow on the motorway, ramp signals and signs, in the form and the display in 6.4(17) or the display and signal sequence in 6.4(19) and (20), must be used for the periods for which they are required.
- 6.4(17) A ramp signal must comprise at least:
- (a) for each approach lane to the signals on the ramp a display mounted on a single column (display A) with two single-column, 3-aspect traffic signals (*figure 3A* of *S4-3* in *Schedule 3*) separated by a traffic sign that displays the words ‘One Vehicle Per Green Each Lane’; and
 - (b) for each approach to the ramp and visible to approaching drivers in sufficient time to give them the option of avoiding entering the ramp, a display (display B) with a variable traffic sign that displays either the words ‘Ramp Signal On’ or a blank message; and
 - (i) where approach speeds are likely to exceed 70 km/h, one yellow disc signal mounted above the variable traffic sign and one yellow disc signal mounted below it; or
 - (ii) where approach speeds are not likely to exceed 70 km/h, the yellow disc signals may be omitted.
- 6.4(18) A ramp signal may also include, for each approach lane on the ramp in advance of display A, a display (display C) with a traffic signal warning sign erected above a variable traffic sign that displays either the words ‘Prepare to Stop’ or ‘Ramp Signal Off’.

- 6.4(19) When the ramp signal is in the 'off' state:
- (a) in display A, none of the traffic signal aspects may be illuminated; and
 - (b) in display B, the yellow disc signals, if present, and the variable traffic sign must be blank; and
 - (c) in display C, the variable traffic sign must read 'Ramp Signal Off'.
- 6.4(20) When the ramp signal is operational:
- (a) in display A, the signal display must operate in the following sequence:
 - (i) the yellow disc signals, must flash at approximately one Hertz, for a period of at least 10 seconds followed by:
 - (ii) the red disc signals followed by:
 - (iii) the green disc signals displayed for a maximum period of 1.3 seconds followed by:
 - (iv) the yellow disc signals displayed for a maximum period of 0.7 seconds followed by:
 - (A) the red disc signals in (a)(ii); or
 - (B) the red disc signals for at least 3 seconds followed by the ramp signals moving to the 'off' state described in 6.4(19);
 - (b) in display B, the variable traffic sign must read "Ramp Signal On" and the yellow disc signals, if present, must comply with the specifications in *Schedule 3* and flash alternatively at approximately one Hertz with approximately equal on- and off-times.
 - (c) in display C, the variable traffic sign must read 'Prepare to Stop'.

Temporary traffic signals

- 6.4(21) A road controlling authority may install and operate temporary traffic signals, for a continuous period not exceeding six months, to control traffic only when:
- (a) because of road works or other temporary obstruction, a section of road has been reduced in width to one lane or must be closed to through traffic periodically; or

- (b) a temporary intersection has been created to allow construction vehicles or other vehicles to cross or enter a roadway.

6.4(22) Temporary traffic signals may operate only when:

- (a) temporary warning signs are installed advising approaching drivers that the traffic signals are operating; and
- (b) the sequence and timing of displays and other operating requirements of the signals comply with a traffic management plan approved by the road controlling authority.

6.4(23) Temporary traffic signals may operate for non-continuous periods at the same site provided that the signals and all temporary warning signs associated with their operation are removed, securely covered or are otherwise not visible to approaching drivers when the signals are not operating.

Clause 6.4(1): amended, on 1 April 2011, by *clause 2.10(1)* of *Land Transport Rule: Traffic Control Devices Amendment 2010*.

Clause 6.4(2A): inserted, on 1 November 2014, by *clause 2.4(1)* of *Land Transport Rule: Traffic Control Devices Amendment 2014*.

Clause 6.4(3)(d): replaced, on 1 November 2014, by *clause 2.4(2)* of *Land Transport Rule: Traffic Control Devices Amendment 2014*.

Clause 6.4(10)(a): amended, on 1 June 2019, by *clause 2.3* of *Land Transport Rule: Traffic Control Devices Amendment 2019*.

Clause 6.4(11)(c): replaced, on 15 September 2005, by *clause 2.2* of *Land Transport Rule: Traffic Control Devices Amendment 2005*.

Clause 6.4(13): replaced, on 1 April 2011, by *clause 2.10(2)* of *Land Transport Rule: Traffic Control Devices Amendment 2010*.

Clause 6.4(14): replaced, on 1 April 2011, by *clause 2.10(2)* of *Land Transport Rule: Traffic Control Devices Amendment 2010*.

Clause 6.4(14A): inserted, on 1 April 2011, by *clause 2.10(2)* of *Land Transport Rule: Traffic Control Devices Amendment 2010*.

Clause 6.4(15): replaced, on 1 April 2011, by *clause 2.10(2)* of *Land Transport Rule: Traffic Control Devices Amendment 2010*.

Clause 6.4(17)(a): replaced, on 6 October 2006, by *clause 2.2(1)* of *Land Transport Rule: Traffic Control Devices Amendment 2006*.

Clause 6.4(17)(b): amended, on 1 November 2014, by *clause 2.4(3)* of *Land Transport Rule: Traffic Control Devices Amendment 2014*.

Clause 6.4(17)(b)(i): inserted, on 1 November 2014, by *clause 2.4(4)* of *Land Transport Rule: Traffic Control Devices Amendment 2014*.

Clause 6.4(17)(b)(ii): inserted, on 1 November 2014, by *clause 2.4(4)* of *Land Transport Rule: Traffic Control Devices Amendment 2014*.

Clause 6.4(19)(a): amended, on 6 October 2006, by *clause 2.2(2)* of *Land Transport Rule: Traffic Control Devices Amendment 2006*.

Clause 6.4(19)(b): amended, on 1 November 2014, by *clause 2.4(5)* of *Land Transport Rule: Traffic Control Devices Amendment 2014*.

Clause 6.4(20)(a): amended, on 6 October 2006, by *clause 2.2(3)* of *Land Transport Rule: Traffic Control Devices Amendment 2006*.

Clause 6.4(20)(b): replaced, on 1 November 2014, by *clause 2.4(6)* of *Land Transport Rule: Traffic Control Devices Amendment 2014*.

6.5 Flashing vehicle displays

Flashing yellow displays for warning of signal malfunction

- 6.5(1) If traffic signals are out of order because of a signal display outage or for maintenance, yellow signals flashing at approximately one Hertz with approximately equal on- and off-times must be displayed and be visible to all traffic approaching the area controlled by the traffic signals.

Flashing yellow displays for signal commissioning or restart

- 6.5(2) When traffic signals are commissioned, or are being restarted after a signal outage in 6.5(4)(a) has ended, yellow disc signals flashing at approximately one Hertz must be displayed, and must be:
- (a) visible to all traffic approaching the area controlled by the traffic signals; and
 - (b) displayed for at least 10 seconds and be followed by a period of at least three seconds when all approaches to the area controlled by the traffic signals are displaying red signals.
- 6.5(3) For the avoidance of doubt, 6.5(2) does not apply to a signal controller installed before the commencement of this rule, provided it complies when upgraded or replaced.
- 6.5(4) A signal display outage occurs when:
- (a) the signals cease to operate because of:
 - (i) a power failure occurring; or
 - (ii) the signals being switched off temporarily with the approval of the road controlling authority; or
 - (b) a traffic signal controller detects non-compliance with:
 - (i) *subclause 6.4(4)* and only one full operating signal display remains functioning for that approach; or
 - (ii) *subclause 6.4(5), 6.4(6) or 6.4(7)*.

Flashing yellow displays for advance warning traffic signals

- 6.5(5) A road controlling authority may install advance-warning traffic signals when queues of traffic regularly occur or there are traffic signals in close proximity, and:
- (a) the existing road alignment does not provide sufficient safe stopping distance of the queue or traffic signals and cannot reasonably be altered to overcome the deficiency; and
 - (b) the road controlling authority has considered the use of advance-warning signs and considers that advance-warning traffic signals are more appropriate.
- 6.5(6) Advance-warning traffic signals must comprise two yellow disc signals that comply with the specifications in *Schedule 3* and that flash alternately at approximately one Hertz with approximately equal on- and off-times.
- 6.5(7) Advance-warning traffic signals must flash only when:
- (a) a queue has been detected that requires that approaching drivers be informed; or
 - (b) the yellow or red signal is displayed on the traffic signals installed in close proximity.
- 6.5(8) A road controlling authority must install a warning sign and one of the accompanying supplementary warning signs in *Schedule 1* in conjunction with advance-warning traffic signals.
- 6.5(9) When providing advance-warning traffic signals, a road controlling authority must install the signals:
- (a) on the left-hand side of the road (except if they would not be visible to approaching road users, then they may be installed on the right-hand side of the road); and
 - (b) so that the signals:
 - (i) face road users approaching the signals; and
 - (ii) are visible to approaching road users.
- 6.5(10) A road controlling authority may install additional advance-warning traffic signals to increase the effectiveness of the advance-warning traffic signals.
- Flashing red displays for level crossings*
- 6.5(11) Traffic signals at a level crossing must comprise two red disc signals mounted horizontally that flash alternately.

- 6.5(12) While the signals in 6.5(11) are flashing, they may be supplemented with an audible warning device as an additional warning to road users not to enter the controlled area.
- Flashing red displays for special situations and emergency vehicle access*
- 6.5(13) Signals for controlling traffic in special situations or at emergency vehicle access points must comprise:
- (a) two red disc signals mounted horizontally or vertically; or
 - (b) two red disc signals mounted horizontally and placed immediately above a yellow disc signal.
- 6.5(14) The signals in 6.5(13)(b) must operate in the following sequence:
- (a) a steady yellow disc signal that must be displayed for at least three seconds and for no longer than six seconds;
 - (b) two red disc signals that must flash alternately and, after the minimum time consistent with safe operation, a blank display.
- 6.6 Pedestrian displays**
- 6.6(1) A road controlling authority may install pedestrian traffic signals only in conjunction with steady vehicle displays.
- 6.6(2) If providing pedestrian traffic signals, a road controlling authority must install the signals in a position on a roadway under its control so that the signals clearly indicate to pedestrians when they may enter the roadway.
- 6.6(3) Pedestrian traffic signals must comprise the following:
- (a) a green walking human figure signal; and
 - (b) a red standing human figure signal placed immediately above the green human figure signal.
- 6.6(3A) A countdown pedestrian signal, comprising a white or yellow display (conforming to the description in *Schedule 3*) showing the number of seconds remaining in the pedestrian clearance period, may only be installed beside pedestrian traffic signals at:
- (a) mid-block pedestrian traffic signals; or
 - (b) intersections where all of the approaches to the area controlled by traffic signals are controlled by red signals at the same time while pedestrians are permitted to cross.

- 6.6(3B) A countdown pedestrian signal, described in 6.6(3A), must only be displayed at the same time as the flashing red standing human figure display described in 6.6(4).
- 6.6(4) Except as provided in 6.6(5), pedestrian traffic signals must operate in the following sequence:
- (a) a steady green walking human figure symbol to indicate the period during which a pedestrian is allowed to enter a roadway followed by a flashing red standing human figure symbol to indicate the period during which a pedestrian is expected to finish crossing a roadway;
 - (b) either the display at (a) or a steady red standing human figure, displayed for at least two seconds, to indicate when a pedestrian must not enter a roadway followed by:
 - (i) the display at (a); or
 - (ii) a blank display followed by:
 - (A) the display at (a); or
 - (B) a steady red standing human symbol followed by the display at (a).
- 6.6(5) A nearside pedestrian traffic signal may only be installed at mid-block pedestrian traffic signals and must operate in the following sequence:
- (a) a steady green walking human figure symbol to indicate the period during which a pedestrian is allowed to enter a roadway followed by;
 - (b) a steady red standing human figure, displayed for at least two seconds, to indicate when a pedestrian must not enter a roadway followed by:
 - (i) the display at (a); or
 - (ii) a blank display followed by:
 - (A) the display at (a); or
 - (B) a steady red standing human symbol followed by the display at (a).

[Note: See definitions of 'mid-block pedestrian traffic signal' and 'nearside pedestrian traffic signal' in *Part 2 Definitions*.]

Clause 6.6(3A): inserted, on 1 April 2011, by *clause 2.11(1)* of *Land Transport Rule: Traffic Control Devices Amendment 2010*.

Clause 6.6(3B): inserted, on 1 April 2011, by *clause 2.11(1)* of *Land Transport Rule: Traffic Control Devices Amendment 2010*.

Clause 6.6(4): amended, on 1 April 2011, by *clause 2.11(2)* of *Land Transport Rule: Traffic Control Devices Amendment 2010*.

Clause 6.6(5): inserted, on 1 April 2011, by *clause 2.11(3)* of *Land Transport Rule: Traffic Control Devices Amendment 2010*.

Note after clause 6.6(5): inserted, on 1 April 2011, by *clause 2.11(3)* of *Land Transport Rule: Traffic Control Devices Amendment 2010*.

Section 7 Channelling traffic

7.1 Provision of traffic control devices for channelling traffic

7.1(1) A road controlling authority may provide traffic control devices to channel traffic for the purposes of improving traffic safety and the efficiency of traffic movement.

7.1(2) Channelling traffic is achieved by using traffic control devices, separately or in combination, to define parts of a roadway that are generally available to road users.

7.1(3) Traffic control devices that are used to channel traffic include:

- (a) centre-lines;
- (aa) wide centre-lines;
- (b) no-passing lines;
- (c) flush medians;
- (d) edgelines;
- (e) shoulder markings;
- (f) traffic islands either raised above, or flush with, the road surface;
- (g) turn bays;
- (h) kerbs, slow points, chicanes and other structures;
- (i) delineators;
- (j) lane lines;
- (k) variable lane control signs.

Clause 7.1(3): amended, on 1 January 2014, by *clause 2.2* of *Land Transport Rule: Traffic Control Devices Amendment 2013*.

7.2 Centre-lines

7.2(1) A road controlling authority may mark a centre-line on a roadway that is 5.1 m or more in width.

7.2(2) A centre-line must be marked with:

- (a) a white broken or continuous single line that is not less than 100 mm wide; or
- (b) a regular pattern of raised white pavement markers; or
- (c) a no-passing line in one of the forms described in 7.3; or
- (d) a continuous white line bounding a flush median as described in 7.4, or
- (e) wide centre-lines as described in 7.2A.

7.2(3) On a two-way roadway that is marked in three or more lanes (not including cycle lanes), the two directions of traffic must, as appropriate to the number of lanes, the speed limit and the anticipated volume of traffic, be separated or indicated by the following:

- (a) a barrier; or
- (b) median; or
- (c) a centre-line, which must be defined by marking:
 - (i) a white, continuous line distinguishable from the lines marking the lanes; or
 - (ii) a no-passing line in one of the forms described in 7.3; or
 - (iii) a flush median described in 7.4; or
 - (iv) wide centre-lines as described in 7.2A; or
- (d) the use of variable lane control signs installed in accordance with 7.13.

7.2A Wide centre-lines

7.2A(1) A road controlling authority may mark wide centre-lines on a roadway if the road controlling authority considers that increasing the separation between traffic travelling in opposite directions would improve the overall operating safety of the road.

7.2A(2) Wide centre-lines must be marked with two approximately parallel lines spaced not less than 0.5 m and not more than 1.5 m apart and each of which is one of the following:

- (a) a broken or continuous white centre-line that is not less than 100 mm wide; or
- (b) a continuous yellow no-passing line that is not less than 100 mm wide; or

- (c) a line preceding a no-passing line that is not less than 100 mm wide and consists of a series of yellow dashes, each of which is not longer than 15 m.

Clause 7.2(2)(d): amended, on 1 January 2014, by *clause 2.3(1)* of *Land Transport Rule: Traffic Control Devices Amendment 2013*.

Clause 7.2(2)(e): inserted, on 1 January 2014, by *clause 2.3(2)* of *Land Transport Rule: Traffic Control Devices Amendment 2013*.

Clause 7.2(3)(c): amended, on 1 January 2014, by *clause 2.3(3)* of *Land Transport Rule: Traffic Control Devices Amendment 2013*.

Clause 7.2A: inserted, on 1 January 2014, by *clause 2.3(4)* of *Land Transport Rule: Traffic Control Devices Amendment 2013*.

7.3 No-passing lines

- 7.3(1) A road controlling authority may mark a no-passing line on a section of roadway if the road controlling authority considers that there is a risk to safety from vehicles that, when passing other vehicles (other than stationary vehicles or cycles) that are moving in the same direction, intrude into a lane that is being used by traffic travelling in the opposite direction.
- 7.3(2) A no-passing line applies to traffic that normally travels to the left of the line and must consist of a continuous yellow line not less than 100 mm wide that is marked:
- (a) approximately 100 mm to the left of either:
 - (i) another continuous yellow line; or
 - (ii) a broken or continuous white line in the form described in 7.2(2)(a); or
 - (iii) a dashed yellow line in the form described in 7.3(3); or
 - (iv) a regular pattern of raised white or yellow pavement markers; or
 - (b) not less than 0.5 m and not more than 1.5 m to the left of another line that together with the no-passing line forms wide centre-lines as described in 7.2A.
- 7.3(3) If practicable, a no-passing line must be preceded by a line not less than 100 mm wide and consisting of a series of yellow dashes, each of which is not longer than 15 m, to inform drivers of the existence of the no-passing line ahead.

Clause 7.3(2): replaced, on 1 January 2014, by *clause 2.4* of *Land Transport Rule: Traffic Control Devices Amendment 2013*.

7.4 Flush medians

- 7.4(1) A road controlling authority may mark a flush median on a roadway if the road controlling authority considers there would be safety and efficiency benefits in:
- (a) separating turning traffic and through traffic; or
 - (b) providing pedestrians with a place to pause while crossing a road; or
 - (c) providing greater separation between traffic travelling in opposite directions; or
 - (d) limiting lane widths to reduce traffic speed.
- 7.4(2) A flush median must comprise an area marked by white diagonal lines that are painted along the middle of the roadway and are bounded by approximately parallel, longitudinal white lines.

7.5 Edgelines

- 7.5(1) If a road controlling authority considers it is desirable, it may mark an edgeline at or near the far left or far right side of the roadway to define an area of roadway for use by vehicles.
- 7.5(2) An edgeline must be marked or defined by one or more of the following:
- (a) a broken or continuous white line; or
 - (b) a kerb.

7.6 Shoulder markings

- 7.6(1) A road controlling authority may mark white diagonal shoulder markings on a road if the road controlling authority considers it is desirable to differentiate the shoulder from the roadway.
- 7.6(2) A road controlling authority must mark a sealed shoulder in the form described in 7.6(1) if it is:
- (a) 2.5 m wide or more, exclusive of any marked parking area; and
 - (b) being used, or is likely to be used, by motor vehicles as a lane.

7.7 Traffic islands

- 7.7(1) A road controlling authority may provide a traffic island to:
- (a) channel traffic;

- (b) provide protection for pedestrians, cyclists or other road users crossing a road;
- (c) give advance warning of an intersection to approaching traffic;
- (d) provide for, and protect, traffic control devices;
- (e) prevent undesirable or unnecessary traffic movements.

Raised traffic islands

7.7(2)

When providing a raised traffic island, a road controlling authority must:

- (a) install, on the traffic island, reflectorised traffic signs complying with *section 4* that the road controlling authority considers are necessary to guide drivers around the traffic island; and
- (b) place markings or delineators on the roadway beside the traffic island to inform drivers of the presence and extent of the traffic island.

7.7(3)

Before a road controlling authority installs, plants or places any object on a raised traffic island, it must consider the purpose of that object and the risks to road users. If the road controlling authority determines that the object is necessary, or that the risk it poses requires management, the road controlling authority must:

- (a) install barriers around the object; or
- (b) ensure that the object is frangible; or
- (c) take such measures as are reasonable in the circumstances to mitigate any foreseeable risk.

Flush traffic islands

7.7(4)

A flush traffic island must have:

- (a) its area defined by continuous white lines; and
- (b) a pattern of white diagonal lines or chevron stripes in the area within the edgelines, if the size of the island allows or requires this.

Clause 7.7(3): replaced, on 1 November 2015, by clause 2.2 of Land Transport Rule: Traffic Control Devices Amendment 2015.

7.8 Turn bays

- 7.8(1) A road controlling authority may mark a turn bay on a roadway if the road controlling authority considers that there would be safety or efficiency benefits in separating turning traffic from through traffic.
- 7.8(2) A right-turn bay, which may incorporate white diagonal markings, must be bounded by:
- (a) a centre-line to the right, in the form described in 7.2(2); and
 - (b) a dashed or continuous line to the left.
- 7.8(3) A left-turn bay may be bounded by:
- (a) a lane line to the right, in a form described in 7.11(b)(i); and
 - (b) a dashed or continuous white line to the left.

7.9 Kerbs, slow points, chicanes and other structures

- 7.9(1) A road controlling authority may provide a traffic control device, including a kerb, road hump, chicane, or slow point, on or adjacent to a road, as appropriate, to:
- (a) channel traffic movement; or
 - (b) restrict the speed of traffic; or
 - (c) discourage the use of the road by through vehicles in general or by vehicles of an inappropriate design or size, and for which alternative routes are available; or
 - (d) provide a continuation of a pedestrian or cycle route and alert drivers to the presence of pedestrians or cyclists.
- 7.9(2) A road controlling authority may use signs, markings or delineators in conjunction with a structure in 7.9(1).
- 7.9(3) A road hump, chicane, slow point or other channelling device, on or adjacent to a road, that is intended to reduce the travelling speed of vehicles must be illuminated or have reflective delineators or reflective signs installed so that the structure is visible.
- 7.9(4) Permanent growth, or a traffic control device or other object placed on a structure in 7.9(1), must not impair visibility.

7.10 Delineators

- 7.10(1) A road controlling authority may use delineators to regulate, warn or advise traffic.
- 7.10(2) Delineators have the following functions:
- (a) ‘regulatory’, that is, they instruct road users by requiring or prohibiting specified actions in using a roadway, when used:
 - (i) to supplement, or as a substitute for, markings; or
 - (ii) to override markings for the purposes of temporary traffic management;
 - (b) ‘warning’, that is, they inform road users of hazards on a roadway or give advance notice of features on or near the roadway;
 - (c) ‘advisory’, that is, they provide road users with information and guidance in using a road more effectively and safely.
- 7.10(3) Delineators, if used to provide road users with an indication of the travel path to follow, must be installed:
- (a) at regular intervals on substantially straight sections of roadway; and
 - (b) at intervals based on the degree of curvature or lateral movement where there are curves or changes in direction.

7.11 Lane lines

A lane line may be:

- (a) marked or indicated by one or more traffic control devices in 7.1(3)(a) to (i); or
- (b) marked with:
 - (i) a white broken or continuous single line that is not less than 100 mm wide; or
 - (ii) a regular pattern of raised white pavement markers.

7.12 Lanes

- 7.12(1) A lane, including a cycle lane, may be indicated to road users by one or more traffic control devices used singly or in combination, including:
- (a) traffic control devices in 7.1(3); or

- (b) other markings that comply with *section 5*.
- 7.12(2) If the use of a lane is restricted to a specific class or classes of vehicle, the traffic control devices that indicate the restriction must comply with *section 11*.
- 7.12(3) A lane that may be used only by road users who are travelling straight ahead or turning in a specific direction must be clearly indicated by:
- (a) at least one lane-usage arrow marked within the lane that complies with the relevant specifications in *Schedule 2*; or
 - (b) at least one sign provided above the lane that complies with the relevant requirements in *Schedule 1*.

7.13 Variable lane control signs

- 7.13(1) The use of a lane may be controlled by means of variable lane control signs that are installed above the lane and that display:
- (a) a red diagonal cross, indicating that the lane is not available to road users that are travelling in the direction facing the sign; or
 - (b) a green downward-facing arrow, indicating that the lane may be used by road users that are travelling in the direction facing the sign; or
 - (c) a yellow diagonal arrow facing to the bottom left or right corner of the sign, indicating that road users must, as soon as practicable, move to the adjacent lane to the left or right; or
 - (d) if 7.13(7) applies, a blank display indicating to road users that the lane is available for use.
- 7.13(2) The symbols in 7.13(1) must comply with the relevant requirements in *Schedule 1*.
- 7.13(3) If a lane has road users travelling in opposite directions at different times, only the following combinations of symbols may be displayed:
- (a) a green downward-facing arrow displayed for one direction with a red diagonal cross displayed for the opposite direction;
 - (b) a yellow diagonal arrow displayed for one direction with a red diagonal cross displayed for the opposite direction;
 - (c) a red diagonal cross displayed in both directions.

- 7.13(4) If the use of a lane is changed so as to reverse the direction in which road users must travel, the symbols displayed must have the following sequence:
- (a) a green downward-facing arrow displayed for one direction with a red diagonal cross displayed for the opposite direction, followed by either:
 - (i) a diagonal yellow arrow displayed for one direction with a red diagonal cross displayed for the opposite direction followed by a red diagonal cross displayed for both directions; or
 - (ii) a red diagonal cross displayed in both directions;
 - (b) a red diagonal cross displayed for one direction with a green downward-facing arrow displayed for the opposite direction, in the reverse order from that specified in (a).
- 7.13(5) A red diagonal cross specified in 7.13(4)(a)(i) or (ii) that is displayed concurrently for both directions must operate for a period that allows safe clearance of traffic from the lane.
- 7.13(6) If the use of a lane is changed to exclude road users travelling in one direction for a period, after which the lane reopens for road users travelling in the same direction, the symbols displayed must comply with the sequence in 7.13(4)(a)(i) or (ii), followed by a green downward-facing arrow displayed for the one direction with a red diagonal cross displayed for the opposite direction.
- 7.13(7) If lanes used for road users that are travelling in opposite directions are separated by physical barriers:
- (a) the signs above each lane may be a green downward-facing arrow, a yellow diagonal arrow, a diagonal red cross or a blank display facing road users travelling in that lane; and
 - (b) symbols do not have to be displayed for road users travelling in the opposite direction.
- 7.13(8) If 7.13(7) applies, the symbols displayed must comply with either of the following sequences:
- (a) a green downward-facing arrow or a blank display, followed by a diagonal yellow arrow, followed by either:
 - (i) a diagonal red cross followed by a green downward-facing arrow; or
 - (ii) a green downward-facing arrow; or

- (b) a blank display followed by a diagonal yellow arrow, followed by either:
 - (i) a red diagonal cross, followed by a blank display; or
 - (ii) a blank display.

Section 8 Pedestrian crossings, school crossing points, school patrols and other pedestrian facilities

8.1 Provision of traffic control devices for pedestrians

8.1(1) A road controlling authority must use one or more of the following means of controlling traffic when requiring drivers to stop their vehicle while pedestrians cross a roadway:

- (a) providing a pedestrian crossing;
- (b) authorising a school patrol, and:
 - (i) specifying the pedestrian crossing at which it may operate; or
 - (ii) providing a school crossing point at which the school patrol operates;
- (c) providing pedestrian traffic signals.

8.1(2) A road controlling authority may use one or more of the following means of assisting pedestrians to cross a roadway but which, unless installed in conjunction with one of the devices described in 8.1(1), does not require a driver to stop their vehicle while a pedestrian crosses the roadway:

- (a) school wardens;
- (b) devices, including:
 - (i) signs;
 - (ii) markings, including flush medians;
 - (iii) surface texture or raised platforms;
 - (iv) kerb extensions or traffic islands.

8.2 Pedestrian crossings

8.2(1) A road controlling authority may, except for areas controlled by traffic signals, mark a pedestrian crossing on a road for which a speed limit of 50 km/h or less is set.

8.2(2) A road controlling authority may mark a pedestrian crossing on a road for which a speed limit of more than 50 km/h is set if it

- has obtained the approval of the Agency and complies with any conditions specified in the approval.
- 8.2(3) A pedestrian crossing must be marked in reflectorised white and as specified in *Schedule 2*.
- 8.2(3A) If white does not contrast with the colour of the adjacent roadway, the roadway must be resurfaced or marked to provide a contrast to the white lines.
- 8.2(4) A pedestrian crossing must be marked in accordance with 8.2(3), and if applicable with 8.2(3A), by 30 June 2007.
- 8.2(5) A pedestrian crossing must not, by 30 June 2006, exceed 15 m from one side of the roadway to the other side unless it is:
- (a) interrupted by one or more traffic islands to form two or more pedestrian crossings; or
 - (b) replaced by traffic signals.
- 8.2(6) Markings for a pedestrian crossing must be placed, as far as practicable, either at right angles to the middle line of the roadway or so as to provide the most convenient route for pedestrians.
- 8.2(7) A pedestrian crossing must be placed so that:
- (a) it is visible to a driver approaching the crossing from any direction; and
 - (b) the driver's view of the entire length of the pedestrian crossing is unobstructed by any permanent growth, construction or physical feature.

Lighting pedestrian crossings

- 8.2(8) A pedestrian crossing, other than a pedestrian crossing that in the opinion of the road controlling authority will not generally be used at night, must be kept illuminated when street lights are operating so that the crossing markings and a pedestrian on the crossing are visible.

Poles, markings and other indicators of pedestrian crossings

- 8.2(9) A road controlling authority must install, within 2 m from each end of a pedestrian crossing and on a traffic island that separates two pedestrian crossings, a pole that is:
- (a) 75 mm or more in width and 2 m or more in height; and
 - (b) marked with alternate parallel bands of black and white, which may be reflectorised, each of which is approximately 300 mm wide.

- 8.2(10) A road controlling authority must place on every pole in 8.2(9) either:
- (a) an internally illuminated amber globe (that may flash at between 40 to 60 flashes each minute) that is 300 mm or more in diameter; or
 - (b) a fluorescent, reflectorised orange sign in the form of a disk that is 400 mm or more in diameter.
- 8.2(11) To inform approaching traffic of the presence of a pedestrian crossing, a road controlling authority, on each approach to the pedestrian crossing:
- (a) must place a pedestrian crossing warning sign before the pedestrian crossing; and
 - (b) must, if practicable, mark a limit line that consists of a white line that is not less than 300 mm wide and not less than 5 m from the pedestrian crossing; and
 - (c) may mark a pedestrian crossing warning marking in the form of a diamond on the road surface.
- 8.2(12) To inform approaching traffic of the presence of a pedestrian waiting to cross at a pedestrian crossing, a road controlling authority may install and maintain an on-roadway flashing yellow light system that is:
- (a) installed as described in diagram M1-4 of *Schedule 2*; and
 - (b) illuminated only when a pedestrian waiting to cross is detected and remains illuminated only for a period sufficient to permit the pedestrian to cross the pedestrian crossing.

Clause 8.2(2): amended, on 1 August 2008, by *Part 2 of Schedule 3 of the Land Transport Management Amendment Act 2008*.

Clause 8.2(3A): inserted, on 6 October 2006, by *clause 2.3(1) of Land Transport Rule: Traffic Control Devices Amendment 2006*.

Clause 8.2(4): replaced, on 6 October 2006, by *clause 2.3(2) of Land Transport Rule: Traffic Control Devices Amendment 2006*.

Clause 8.2(5): amended, on 6 October 2006, by *clause 2.3(3) of Land Transport Rule: Traffic Control Devices Amendment 2006*.

Clause 8.2(7)(b): replaced, on 1 November 2014, by *clause 2.5(1) of Land Transport Rule: Traffic Control Devices Amendment 2014*.

Clause 8.2(10)(b): amended, on 17 January 2008, by *clause 2.1 of Land Transport Rule: Traffic Control Devices Amendment 2007*.

Clause 8.2(11)(b): replaced, on 6 October 2006, by *clause 2.4 of Land Transport Rule: Traffic Control Devices Amendment 2006*.

Clause 8.2(12): inserted, on 1 April 2011, by clause 2.12 of Land Transport Rule: Traffic Control Devices Amendment 2010.

8.3 School patrols

- 8.3(1) A road controlling authority may, in writing, authorise the Board of Trustees of a school to appoint persons as members of school patrols at specified school crossing points or pedestrian crossings to assist, direct and supervise children on their way to or from school.
- 8.3(2) When appointing members of school patrols the Board of Trustees:
- (a) for a school crossing point, must appoint adults to supervise the school patrol and school crossing point; and
 - (b) for a marked pedestrian crossing, may appoint adults to supervise the school patrol and pedestrian crossing.
- 8.3(3) A road controlling authority may, at any time, by notice in writing, withdraw an authorisation it has given under 8.3(1).
- 8.3(4) The Agency may require that a road controlling authority withdraw an authorisation given under 8.3(1).
- 8.3(5) The withdrawal of an authorisation under 8.3(3) or 8.3(4) takes effect when the road controlling authority or the Agency notifies the Board of Trustees, in writing, of the withdrawal.
- 8.3(6) A member of a school patrol must wear, as appropriate, a raincoat or vest that identifies them clearly and enables them to be visible to approaching drivers.
- 8.3(7) A member of a school patrol must use a 'School Patrol' sign that complies with *Schedule 1* mounted on a white or black and white striped pole at least 35 mm in diameter and not less than 1.5 m in length.

Functions and duties of school patrols

- 8.3(8) A school patrol must control the approach of the driver of a vehicle to a pedestrian crossing or school crossing point by extending into the roadway, and keeping extended, the 'School Patrol' sign, so as to display its wording clearly to the driver and, at the same time, may direct pedestrians to enter the crossing.
- 8.3(9) A school patrol must not extend the 'School Patrol' sign into the roadway to stop a vehicle except during a pause in the flow of traffic, having regard to the number of vehicles approaching the crossing.

Clause 8.3(4): amended, on 1 August 2008, by *Part 2 of Schedule 3 of the Land Transport Management Amendment Act 2008.*

Clause 8.3(5): amended, on 1 August 2008, by *Part 2 of Schedule 3 of the Land Transport Management Amendment Act 2008.*

8.4 School crossing points

- 8.4(1) A road controlling authority may provide a school crossing point on a road for which a speed limit of 50 km/h or less is set.
- 8.4(2) A road controlling authority may provide a school crossing point on a road for which a speed limit of more than 50 km/h is set if it has obtained the approval of the Agency and complies with the conditions of the approval.
- 8.4(3) Before establishing a school crossing point, a road controlling authority must obtain the agreement of the Board of Trustees of each school that is served by the school crossing point.
- 8.4(4) A school crossing point must be placed so that:
- (a) it, and the school patrol when operating, is visible to a driver approaching the crossing point from any direction; and
 - (b) the driver's view of the entire length of the crossing is unobstructed by any permanent growth, construction or physical feature.
- 8.4(5) A road controlling authority must indicate the presence and position of a school crossing point by marking or installing in accordance with the relevant requirements of *Schedule 2*:
- (a) a white, reflectorised limit line on each approach; and
 - (b) at each end of the crossing point, a permanent white support post or pole; and
 - (c) when a school patrol is operating:
 - (i) at least one 'Children' flag sign installed adjacent to each vehicle limit line on each approach to the crossing point; and
 - (ii) a 'School Patrol' sign at each end of the crossing point; and
 - (d) a 'Children' sign, with a 'School' supplementary sign, permanently mounted on each approach to the school crossing point facing approaching traffic.
- 8.4(6) Markings for a school crossing point must be placed, as far as practicable, either at right angles to the middle line of the

roadway or so as to provide the most convenient route for pedestrians.

- 8.4(7) Unless 8.4(8) applies, all ‘School Patrol’ signs and ‘Children’ flag signs must be removed from a school crossing point when a school patrol is not operating.
- 8.4(8) ‘School Patrol’ signs and ‘Children’ flag signs may be stored at a school crossing point in storage devices that must:
- (a) be designed to enclose the circular panel of a school patrol stop sign so that it is not readily visible when inside the storage device; and
 - (b) be white or grey in colour, with white or grey fittings, except that the surfaces of the storage device facing the footpath or the roadway may display a road safety message for pedestrians, providing that the message is not readily visible or distracting to vehicular traffic approaching the school crossing point; and
 - (c) unless the school patrol stop sign handle is white, shield the handle of the school patrol stop sign so that no black and white bands are visible when the school patrol sign is inside the storage device; and
 - (d) be oriented to present the smallest possible dimensions to vehicular traffic approaching the school crossing point.
- 8.4(9) A school patrol sign storage device that complies with 8.4(8)—
- (a) may also be used to store the fluorescent ‘Children’ flag signs if the signs are not readily visible when stored; and
 - (b) may be mounted on the white pole used to hinge the school patrol stop sign at a school crossing point.

Clause 8.4(2): amended, on 1 August 2008, by *Part 2 of Schedule 3 of the Land Transport Management Amendment Act 2008*.

Clause 8.4(4)(b): replaced, on 1 November 2014, by *clause 2.5(2) of Land Transport Rule: Traffic Control Devices Amendment 2014*.

Clause 8.4(5)(d): amended, on 1 November 2015, by *clause 2.3 of Land Transport Rule: Traffic Control Devices Amendment 2015*.

Clause 8.4(7): amended, on 1 June 2019, by *clause 2.4 of Land Transport Rule: Traffic Control Devices Amendment 2019*.

Clause 8.4(8): inserted, on 1 June 2019, by *clause 2.4 of Land Transport Rule: Traffic Control Devices Amendment 2019*.

Clause 8.4(9): inserted, on 1 June 2019, by *clause 2.4 of Land Transport Rule: Traffic Control Devices Amendment 2019*.

8.5 Pedestrian traffic signals

- 8.5(1) A road controlling authority may install pedestrian traffic signals, at an intersection controlled by traffic signals, to indicate to pedestrians when they may enter a roadway.
- 8.5(2) If 8.5(1) applies, markings must be installed to guide the movement of pedestrians.
- 8.5(2A) A road controlling authority may not mark a pedestrian crossing in an area controlled by traffic signals.
- 8.5(3) A road controlling authority may install pedestrian traffic signals complying with *section 6* to control the movement of pedestrians at locations other than intersections.

Clause 8.5(2A): inserted, on 6 October 2006, by clause 2.5 of Land Transport Rule: Traffic Control Devices Amendment 2006.

8.6 Provision and maintenance of pedestrian crossings and school crossing points

A pedestrian crossing or school crossing point on a roadway may be provided and maintained only by the road controlling authority that controls that roadway.

8.7 Removal of pedestrian crossings and indications of pedestrian crossings

- 8.7(1) The Agency may, at any time by notice in writing to a road controlling authority, require the road controlling authority to:
- (a) remove a pedestrian crossing; or
 - (b) remove, or refrain from providing, additional indication of the presence or position of a pedestrian crossing, whether or not the crossing is approved under this rule.
- 8.7(2) On receiving a notice under 8.7(1), the road controlling authority must:
- (a) immediately remove from the area of the pedestrian crossing all markings and other indications of a crossing; or
 - (b) if relevant, immediately remove, and subsequently refrain from providing, the additional indicators referred to in the notice.

Clause 8.7(1): amended, on 1 August 2008, by Part 2 of Schedule 3 of the Land Transport Management Amendment Act 2008.

8.8 Other pedestrian facilities

School wardens

- 8.8(1) A Board of Trustees of a school may appoint a person as a school warden to assist, direct and supervise children at a point at which they may cross the road on their way to and from school.
- 8.8(2) A Board of Trustees must advise the road controlling authority before establishing a school warden system.
- 8.8(3) A school warden must wear, as appropriate, a raincoat or vest that identifies them clearly and enables them to be visible to approaching drivers.

Crossing places

- 8.8(4) A road controlling authority may provide signs, markings, surface texture or raised platforms or kerb extensions and traffic islands or other techniques to guide a pedestrian to a place at which to cross a roadway.
- 8.8(5) If a road controlling authority installs a device in 8.8(4) that does not require a driver to stop their vehicle to allow a pedestrian to cross the roadway, the road controlling authority must ensure that the device conveys a clear and consistent message to road users.

Section 9 Level crossings

9.1 Interpretation

In this section, 'public road' has the same meaning as the definition of 'road' in *section 315 of the Local Government Act 1974*.

9.2 Traffic control devices at level crossings

- 9.2(1) To inform road users of a level crossing and to promote safe responses from road users approaching and crossing the level crossing, a road controlling authority:
- (a) must install warning signs on a public road in advance of the level crossing; and
 - (b) may install warning signs on any other road in advance of a level crossing; and
 - (c) may provide other traffic control devices in advance of the level crossing.

- 9.2(2) A rail access provider, after consultation with the road controlling authority, may install warning signs and other appropriate traffic control devices at a level crossing to promote safe responses from road users at the level crossing.

9.3 Marking level crossings

- 9.3(1) Except if the road surface makes this impracticable, a road controlling authority must mark on a public road, and may mark on any other road, on each lane approaching a level crossing, the word 'RAIL' and the capital letter 'X' when:

- (a) the road approaching the level crossing has a speed limit of 70 km/h or more; or
- (b) traffic approaches the level crossing in more than one lane.

- 9.3(2) The road markings in 9.3(1) must be reflectorised white.

- 9.3(3) On the approaches to a level crossing to which neither 9.3(1)(a) nor 9.3(1)(b) applies, the road controlling authority may, if it considers that additional indication to road users is desirable, place on the road surface the markings in 9.3(1) in accordance with 9.3(2).

- 9.3(4) A rail access provider may mark the road surface of a level crossing with cross-hatching to indicate the area that a road user must not enter when the road user's intended passage through that area is blocked by traffic.

- 9.3(5) An area in 9.3(4) must be marked using yellow reflectorised material and comply with *Schedule 2*.

9.4 Traffic signs, traffic signals and limit lines at level crossings

- 9.4(1) A rail access provider may provide, at a level crossing:

- (a) a give-way sign, stop sign, barrier arms or flashing traffic signals; and
- (b) a crossbuck sign; and
- (c) when there is more than one railway track, a '(number of)' tracks sign.

- 9.4(2) If one of the traffic control devices in 9.4(1)(a) is installed, a rail access provider must, except if the road surface makes this impracticable, mark a limit line at least 300 mm wide at a level crossing, which:

- (a) must be reflectorised yellow, if the level crossing is controlled by a stop sign; or

- (b) must be reflectorised white, if the level crossing is controlled by a give-way sign or by a flashing traffic signal.
- 9.4(3) A rail access provider may install, at a level crossing, poles that have reflectorised red and white alternate bands that are at least 225 mm wide.
- 9.4(4) If a level crossing is controlled by a stop sign, the road controlling authority must mark, not more than 10 m before the limit line, the word 'stop' in capital letters at least 2 m high, unless the road surface makes this impracticable.
- 9.4(5) If a level crossing is controlled by a give-way sign, the road controlling authority must, unless the road surface makes this impracticable, mark, not more than 20 m before the limit line, a triangular give-way symbol that complies with *Schedule 2*.
- 9.4(6) Instead of a triangular symbol in 9.4(5), a roadway that, before the commencement of this rule, was marked by the word 'way' preceded by the word 'give', in capital letters at least 2 m high, may continue to be marked in that way until the words are either permanently removed or overlaid, after which the triangular give-way symbol must be marked.
- 9.4(7) If a level crossing is controlled by a stop sign or give-way sign, a rail access provider may install the following combination of signs on the same pole:
 - (a) a give-way or stop sign; and
 - (b) a crossbuck sign; and
 - (c) if appropriate, a 'Look For Trains' sign or a '(number of)' tracks sign, or both.
- 9.4(8) If a level crossing is controlled by traffic signals, a rail access provider may install the following signs on the poles supporting the traffic signals:
 - (a) a crossbuck sign; and
 - (b) if appropriate, a 'Stop On Red' sign or a '(number of)' tracks sign, or both.
- 9.4(9) If a level crossing is controlled by traffic signals, a rail access provider may install barrier arms on the poles supporting the traffic signals, which must:
 - (a) be lowered over the approach to the level crossing when movement by road traffic is prohibited; and

- (b) consist of reflectorised red and white alternate bands that comply with *Schedule 1*.

Clause 9.4(3): amended, on 1 April 2011, by *clause 2.13(1)* of *Land Transport Rule: Traffic Control Devices Amendment 2010*.

Clause 9.4(9): amended, on 1 April 2011, by *clause 2.13(2)* of *Land Transport Rule: Traffic Control Devices Amendment 2010*.

9.5 Exception in relation to requirements for vehicles to stop at specified level crossings

9.5(1) A road controlling authority may, in compliance with 9.5 of the *Land Transport (Road User) Rule 2004*, install an ‘Exempt’ sign as a supplementary sign to each ‘Level Crossing’ (symbolic train) warning sign installed in advance of the level crossing, if satisfied that:

- (a) rail vehicles are piloted across the level crossing at a speed of less than 15 km/h; and
- (b) the level crossing does not have stop signs installed, and the visibility in either direction along the railway line from a point 37 m in advance of the limit line is 33 m or more; and
- (c) the road is used by scheduled passenger service vehicles or is on a school bus route; and
- (d) the rail access provider has approved the proposed exception.

9.5(2) If any of the conditions in 9.5(1)(a) to (d) does not apply, but the road controlling authority considers that an ‘Exempt’ sign is justified, the road controlling authority must obtain the approval of the Agency for its installation.

Clause 9.5(2): amended, on 1 August 2008, by *Part 2* of *Schedule 3* of the *Land Transport Management Amendment Act 2008*.

Section 10 Intersections

10.1 Intersections to be controlled

An intersection that has four or more approaching roadways must be controlled by:

- (a) stop or give-way signs; or
- (b) a roundabout; or
- (c) traffic signals.

10.2 Intersections controlled by stop signs

If an intersection is controlled by a stop sign, the sign must be installed in accordance with *section 4* and, unless the road surface makes this impracticable, the following must be marked on the roadway:

- (a) a limit line that consists of a yellow line that is not less than 300 mm wide; and
- (b) not more than 10 m before the limit line, the word 'stop' in white capital letters at least 2 m high.

10.3 Intersections controlled by give-way signs

10.3(1) If an intersection is controlled by a give-way sign, the sign must be installed in accordance with *section 4* and, unless the road surface makes this impracticable, the following must be marked on the roadway:

- (a) a limit line that consists of a white line that is not less than 300 mm wide; and
- (b) not more than 20 m before the limit line, a triangular give-way symbol that complies with *Schedule 2*.

10.3(2) Instead of a triangular give-way symbol in *10.3(1)(b)*, a roadway that, before the commencement of this rule, was marked by the word 'way' preceded by the word 'give', in white capital letters at least 2 m high, may continue to be marked in that way until the words are either permanently removed or overlaid, after which the triangular give-way symbol must be marked.

10.4 Intersections controlled by roundabouts

10.4(1) Subject to *10.4(2)*, if an intersection has a roundabout installed, each entry to the roundabout must have a limit line that consists of a white line that is not less than 300 mm wide and must be controlled by either:

- (a) both:
 - (i) a 'give-way roundabout' sign that complies with *Schedule 1*; and
 - (ii) a triangular give-way symbol that complies with *Schedule 2*, marked on the roadway not more than 20 m before the limit line; or
- (b) roundabout metering signals that comply with *section 6*; and

- (i) a 'give-way roundabout' sign that complies with *Schedule 1*, and that has been mounted on a reflectorised, fluorescent yellow-green backing board that provides a border of at least 150 mm; and
 - (ii) a triangular give-way symbol that complies with *Schedule 2*, marked on the roadway not more than 20 m before the limit line; or
- (c) traffic signals.
- 10.4(2) If a single-lane roundabout and its approaches have safe and appropriate engineering measures installed to slow vehicles, and the measured mean operating speeds on the approaches and through the roundabout are 30 km/h or less, the roundabout may operate without the markings, signs or signals described in *10.4(1)*.
- 10.4(3) Instead of a triangular give-way symbol in *10.4(1)(a)(ii)*, a roadway that, before the commencement of this Rule, was marked by the word "way" preceded by the word "give", in white capital letters at least 2 m high, may continue to be marked in that way until the words are permanently removed, after which the triangular give-way symbol must be marked.
- 10.4(4) If more than one lane for motor vehicles enters a roundabout from any approach, a road controlling authority must mark arrows on each approach lane to direct drivers into the correct departure lanes.
- 10.4(5) If a section of the roadway around a roundabout, or an exit from that section of roadway, has more than one lane for motor vehicles, a road controlling authority must mark lane lines to direct the flow of traffic.

Clause 10.4: replaced, on 1 April 2011, by clause 2.14 of Land Transport Rule: Traffic Control Devices Amendment 2010.

10.5 Intersections controlled by traffic signals

- 10.5(1) A road controlling authority must ensure that the form, dimensions, symbols displayed, operation and performance of traffic signals installed at an intersection comply with *section 6*.
- 10.5(2) A road controlling authority may install one or more of the following traffic signs on a pole supporting a traffic signal at an intersection:
- (a) a 'Keep Left' sign;

- (b) a 'Turning Traffic Give-Way To Pedestrians' sign;
- (c) a 'Turn Left At Any Time With Care' sign;
- (d) a sign prohibiting, absolutely or conditionally, pedestrians, vehicles or classes of vehicle from moving in a specific direction;
- (e) a sign requiring, absolutely or conditionally, pedestrians, vehicles or classes of vehicle to move in a specific direction;
- (f) a sign or notice directed solely towards pedestrians and not generally visible to approaching vehicles, warning or advising pedestrians on the use of the traffic signals or of the controlled area;
- (g) a street name sign.

10.6 'Keep Clear' zone at intersections

10.6(1) A road controlling authority may mark the road surface of an intersection, or a place used as a vehicle entrance or exit, to indicate the area that a road user must not enter when the road user's intended passage through that area is blocked by traffic.

10.6(2) An area in *10.6(1)* must be marked, in compliance with *Schedule 2*, by means of either:

- (a) yellow reflectorised material in the form of diagonal cross-hatched markings; or
- (b) the words 'keep clear' marked in yellow between lines that define the area.

Clause 10.6(2): amended, on 1 May 2021, by *clause 2.2 of Land Transport Rule: Traffic Control Devices Amendment 2021*.

Section 11 Traffic control devices for special classes of vehicle and road user

11.1 Provision of signs and markings

A road controlling authority that is providing a special route or setting aside a specific area of roadway for a class or classes of road user that is intended to impose restrictions on other road users must provide signs and markings as specified in *11.2*, *11.3* or *11.4*.

11.2 Special vehicle lanes

11.2(1) If defining a part of a road as a special vehicle lane, a road controlling authority must, at the start of the special vehicle lane and after each intersection, along its length:

- (a) mark on the road surface a white symbol, that complies with *Schedule 2*, defining the class or classes of vehicle for which the lane has been reserved; and
- (b) if for other than a 24-hour restriction, install a special vehicle lane sign that complies with *Schedule 1*:
 - (i) defining the class or classes of vehicle for which the lane has been reserved; and
 - (ii) stating the periods for which the reservation applies.

11.2(2) A road controlling authority may provide the following traffic control devices to discourage use of a special vehicle lane by other vehicles, or to draw attention to the likely presence of vehicles entitled to the use of the lane:

- (a) additional white special vehicle lane symbols described in *11.2(1)(a)* or signs described in *11.2(1)(b)* along the length of the lane; or
- (b) if for a 24-hour restriction, special vehicle lane signs; or
- (c) a surface treatment that provides a contrasting colour or texture to that of adjacent lanes used by other vehicles:
 - (i) at locations along the length of the lane; or
 - (ii) along the length of the lane.

Clause 11.2(1): amended, on 1 April 2011, by *clause 2.15* of *Land Transport Rule: Traffic Control Devices Amendment 2010*.

11.3 Light-rail vehicle facilities

Lanes

11.3(1) If a light-rail vehicle track is within, and runs parallel to, a roadway, a road controlling authority may:

- (a) separate the track from other traffic by installing a traffic island, kerbs or other physical means of channelling traffic; or
- (b) define a special vehicle lane for light-rail vehicles by marking symbols or words defining the class and, where appropriate, installing signs conforming with *11.2(1)(b)*.

Safety zone

- 11.3(2) At a designated light-rail vehicle stop, a road controlling authority may provide a safety zone to warn drivers of, and provide some protection for, passengers entering or leaving the light-rail vehicle.

11.4 Facilities for cycles, wheeled recreational devices and mobility devices

Paths shared by cycles and other users

- 11.4(1) For a shared path used by cycles, a road controlling authority:
- (a) must install appropriate signs or markings that comply with *Schedule 1* or *Schedule 2*, defining the class or classes of path user:
 - (i) at the start of the shared path; and
 - (ii) after each roadway or any other pathway with which it intersects; and
 - (b) must install signs or markings advising users that the shared path ends, unless signs or markings are installed to advise who may use any path that continues beyond the end of the shared path; and
 - (c) may install signs or markings at other intervals along the shared path.
- 11.4(2) If pedestrians, cycles, wheeled recreational devices, or mobility devices are restricted to a specific side or part of a path, or where the path is separated for users travelling in different directions, a road controlling authority:
- (a) must install signs or markings indicating the nature of the restriction:
 - (i) at the start of the restricted section of path; and
 - (ii) after each roadway or any other pathway with which it intersects; and
 - (b) must install signs or markings advising users that the restriction ends, unless signs or markings are installed to advise of any restriction or who may use any path that continues beyond the end of the restricted or separated section of path; and
 - (c) may install signs or markings at other intervals along the restricted section of the path.

Cycle, pedestrian, wheeled recreational device and mobility device signs

- 11.4(3) A road controlling authority may install on the same pole a combination of signs that relate to cycles, to pedestrians, to riders of wheeled recreational devices or to riders of mobility devices.

Parking on footpaths, cycle paths or shared paths

- 11.4(4) A road controlling authority may install facilities for the parking, standing or storage of cycles, wheeled recreational devices or mobility devices on a footpath, footway, cycle path or shared path.

Control where a cycle path or shared path crosses a roadway

- 11.4(5) When a cycle path or a shared path used by cycles crosses a roadway, a road controlling authority may, as appropriate, control either the movement of users of the path or traffic along the roadway by means of stop or give-way signs or by the installation of traffic signals, in the same manner as described in 10.5 for an intersection.

Clause 11.4: replaced, on 1 April 2011, by *clause 2.16 of Land Transport Rule: Traffic Control Devices Amendment 2010.*

Clause 11.4(1): replaced, on 1 June 2019, by *clause 2.5(1) of Land Transport Rule: Traffic Control Devices Amendment 2019.*

Clause 11.4(2): replaced, on 1 June 2019, by *clause 2.5(2) of Land Transport Rule: Traffic Control Devices Amendment 2019.*

11.5 Special motor vehicle facilities

Motorways

- 11.5(1) A road controlling authority that designates a road as a motorway under *section 73 of the Government Roadway Powers Act 1989* must erect appropriate motorway signs, described in *Schedule 1*, that clearly advises road users of the extent of the motorway designation.

Weight and dimension restrictions

- 11.5(2) If a road controlling authority restricts the use of a road, it must install, in advance of the restricted area, signs complying with *Schedule 1* that detail the extent of the restriction, so that drivers have reasonable notice of the restriction.

Special routes or zone restriction for motor vehicles

- 11.5(3) A road controlling authority that is defining a special route or zone restriction under any enactment must provide signs that comply with *Schedule 1*:
- (a) for special routes:
 - (i) in advance of the start of the route; and
 - (ii) in advance of any changes in direction and at intervals to confirm route choice; and
 - (iii) at the end of the route.
 - (b) in advance of, at each entry point to and at each exit point from, a zone restriction.

Road construction zones

- 11.5(4) If a road controlling authority designates a road, or any specified part of a road as a road construction zone, it must mark the boundaries of that zone by signs that comply with *Schedule 1*.

Clause 11.5(1): amended, on 1 August 2008, by *Part 2* of *Schedule 3* of the *Land Transport Management Amendment Act 2008*.

Clause 11.5(3)(a)(iii): inserted, on 1 April 2011, by *clause 2.17(a)* of *Land Transport Rule: Traffic Control Devices Amendment 2010*.

Clause 11.5(3)(b): replaced, on 1 April 2011, by *clause 2.17(b)* of *Land Transport Rule: Traffic Control Devices Amendment 2010*.

11.6 Stock traffic

The owner, or the person in charge, of stock on a road must take steps to ensure that approaching drivers are given reasonable warning of the presence of the stock, and, if a road controlling authority has required and approved a traffic control device for this purpose, must ensure that the device is installed.

11.7 Manually-controlled stop signs

11.7(1) Manually controlled stop sign—

- (a) means a stop sign controlled by a person who—
 - (i) is at the location where the stop sign is displayed; and
 - (ii) has direct line of sight of traffic approaching the stop sign; and
- (b) includes a hand-held stop sign.

- 11.7(2) A manually-controlled stop sign, other than a school patrol sign in 8.3(7), 8.3(8), 8.3(9), or 8.4(5)(c)(ii), may be used only:

- (a) to control traffic for an activity approved by a road controlling authority under a traffic management plan; or
 - (b) to control traffic as part of the movement of an overdimension or overweight vehicle that is operating under *Land Transport Rule: Vehicle Dimensions and Mass 2016*.
- 11.7(3) The operator of a manually-controlled stop sign must control the approach of the driver of a vehicle by displaying the sign to the driver and keeping the sign displayed so that its wording is clearly visible to the driver and may, at the same time, direct vehicles that are travelling in the opposite direction to proceed.
- 11.7(4) The reverse side or alternate display of a manually-controlled stop sign may be blank or display either the word 'go' or the word 'slow'.

Clause 11.7: replaced, on 1 June 2019, by *clause 2.6 of Land Transport Rule: Traffic Control Devices Amendment 2019*.

11.8 **Barrier arms**

If a road controlling authority considers it necessary to control the movement of vehicles beyond a point on a roadway and considers that, to achieve this, it is desirable to use a physical barrier, the road controlling authority may install a barrier arm that:

- (a) must be put in place when movement by road traffic beyond the barrier arm is prohibited; and
- (b) must consist of red and white alternate bands that comply with *Schedule 1*.

Clause 11.8(b): amended, on 1 June 2019, by *clause 2.7 of Land Transport Rule: Traffic Control Devices Amendment 2019*.

Section 12 Stopping, standing and parking

12.1 Requirement to indicate prohibition on stopping

- 12.1(1) If a road controlling authority prohibits, at all times, the stopping of vehicles on a section of road it must advise road users of this by the means specified in *12.2(1)* or *12.2(2)*.
- 12.1(2) If a road controlling authority prohibits the stopping of vehicles on a section of road for a specified period or periods, it must advise road users of this by the means specified in *12.2(2)*.
- 12.1(3) If a road controlling authority considers it necessary to draw the attention of road users to a prohibition, under any enactment, on

the stopping of vehicles on a section of roadway or road, it must do so by the means specified in 12.2(1) or 12.2(2).

- 12.1(4) If a road controlling authority prohibits the stopping of vehicles on a section of road to provide an additional traffic lane or ensure the free-flowing movement of traffic in the adjacent lane, it must do so by the means specified in 12.2(3).
- 12.1(5) If a road controlling authority prohibits the stopping of vehicles on a section of road by setting aside a specific area of roadway for a special vehicle lane, it must do so by the means specified in 11.2.
- 12.1(6) If a road controlling authority conditionally prohibits the stopping of vehicles on a section of road to ensure access to a fire hydrant, it must do so by the means specified in 12.2(5).

12.2 Means of indicating prohibition on stopping

- 12.2(1) A prohibition on stopping may be indicated by marking a broken yellow line that:
- (a) must be not less than 100 mm wide;
 - (b) consists of painted strips not longer than 1 m and separated by gaps not longer than 2 m;
 - (c) if there is a kerb, is not more than 1 m from the adjacent kerb of the roadway to indicate that the stopping of vehicles is prohibited on that side of the roadway;
 - (d) if there is no kerb, is located to indicate that the stopping of vehicles is prohibited if any part of a vehicle stopped on that side of the road is closer to the centre of the road than the broken yellow line.
- 12.2(2) A prohibition on stopping may be indicated by installing 'No Stopping' signs (with arrows or supplementary notices, as appropriate, to define the area and time of application):
- (a) at right angles to the roadway (or in a way that clearly indicates the area of the road to which the restriction applies between any two signs), facing in the direction in which traffic on the side of the roadway in which the sign is installed is approaching the sign; and
 - (b) at a distance between any two signs of not more than 100 m, or 500 m on a road on which a speed limit exceeding 70 km/h is set.

- 12.2(3) A prohibition on stopping may be indicated by installing ‘Clearway’ signs (with supplementary notices, as appropriate, to define the area and time of application):
- (a) at right angles to the roadway facing in the direction in which traffic on the side of the roadway in which the sign is erected is approaching the sign; and
 - (b) that apply to the roadway past the sign in the direction in which that traffic is travelling as far as the next intersection on the same side of the road as the sign or the next ‘Clearway’ sign on that side, whichever is the nearer; and
 - (c) at distances of not more than 100 m between any two signs.
- 12.2(4) A prohibition on stopping may be indicated by installing a special vehicle lane in accordance with 11.2.
- 12.2(5) A road controlling authority may ensure access to a fire hydrant by marking a roadway in accordance with *SNZ PAS 4509:2008 New Zealand firefighting water supplies code of practice*.
- Clause 12.2(5): amended, on 1 April 2011, by clause 2.18 of Land Transport Rule: Traffic Control Devices Amendment 2010.*

12.3 Requirement to indicate restriction on parking

If a road controlling authority imposes a restriction on the parking of vehicles it must instruct road users by the means specified in 12.4.

12.4 Types and means of indicating parking restrictions

Parking at an angle to the roadway

- 12.4(1) If a road controlling authority restricts vehicles to parking only at an angle to the direction of the roadway, the road controlling authority must:
- (a) unless the road surface makes it impracticable, indicate this by marking parallel lines to indicate the allowed angle of parking and may install suitable signs with arrows to denote the extent of the restricted area; or
 - (b) if the road surface makes it impracticable to mark the road, install suitable signs with arrows to denote the extent of the restricted area.
- 12.4(1A) Where a road controlling authority restricts the direction of vehicle entry into angle parking spaces, it must provide a sign

that complies with *Schedule 1*, and that specifies the direction of entry.

Loading zone

- 12.4(2) A road controlling authority may restrict the parking of vehicles by designating an area of road as a loading zone to which a time restriction may also apply.
- 12.4(3) A road controlling authority must provide, in accordance with *12.5*, signs that comply with *Schedule 1*, and that specify the class of vehicle, class of road user or designated activity to which the loading zone is restricted.
- 12.4(4) Except as provided in *12.4(5)*, a road controlling authority must, unless this is impracticable, indicate a loading zone by marking:
- (a) where the parking area is intended for parking parallel to the edge of the roadway:
 - (i) a continuous yellow line at right angles to the kerb or roadway edge at each end of the area of the roadway; and
 - (ii) a broken or continuous yellow line parallel to the kerb or roadway edge, not less than 2 m and not more than 3 m from the kerb or roadway edge; or
 - (b) where the parking area is intended for parking at an angle, a continuous yellow line on the left and right side of each parking space within the loading zone.
- 12.4(5) A marking is not required for a bus stop unless:
- (a) the bus stop is located within a parking zone declared under *12.4(13)*; or
 - (b) the space reserved for a bus extends more than 6 m on either side of a single 'Bus Stop' sign.
- 12.4(5A) A road controlling authority may mark on the area of roadway that is designated as a loading zone, letters or symbols that describe the loading zone and that conform with the specifications in figures M3-1 to M3-3A or M8-1 and M8-2 in *Schedule 2*.

Reserved parking

- 12.4(6) A road controlling authority may restrict the parking of vehicles by designating an area of road for reserved parking, which may be time restricted.

- 12.4(7) A road controlling authority must indicate a reserved parking area by providing, in accordance with 12.5, appropriate signs that comply with *Schedule 1*, and which must specify the class of vehicle, class of road user or designated activity to which the reserved parking area is restricted.
- 12.4(8) A road controlling authority must, unless this is impracticable, mark a reserved parking area:
- (a) where the parking area is intended for parking parallel to the edge of the roadway by:
 - (i) a continuous yellow line at right angles to the kerb or roadway edge at each end of the area of the roadway; and
 - (ii) a broken or continuous yellow line parallel to the kerb or roadway edge, not less than 2 m nor more than 3 m from the kerb or roadway edge; or
 - (b) where the parking area is intended for parking at an angle, a continuous yellow line on the left and right side of each parking space within the reserved parking area.
- 12.4(9) A road controlling authority may mark on an area of roadway that is reserved for parking by a specified class of vehicle or road user, or for a specified purpose, letters or symbols that describe the area reserved for parking and that conform with the specifications in figures M3-5, M3-6, M8-1 or M8-2 in *Schedule 2*.
- 12.4(9A) A road controlling authority may mark, on an area of roadway that is reserved for parking by the holders of approved disabled persons' parking permits, a blue surface texture or colour.
- Time-restricted parking*
- 12.4(10) A road controlling authority may restrict the parking of vehicles by designating an area of road to be time-restricted.
- 12.4(11) A road controlling authority must indicate a time-restricted parking area by providing, in accordance with 12.5, appropriate signs that comply with *Schedule 1*, and which must specify the time limit to which parking in the area is restricted.
- 12.4(12) A road controlling authority may mark on an area of roadway that is time restricted, letters or symbols that describe the restriction and that conform with the specifications in figures M8-1 and M8-2 in *Schedule 2*.

Zone parking

- 12.4(13) A road controlling authority may control the parking of vehicles by declaring an area to be a parking zone that is subject to a parking zone control in accordance with *12.4(13A)* and *12.4(13B)*.
- 12.4(13A) A road controlling authority must only declare an area to be a parking zone if persons using vehicles could reasonably be expected to be aware of the parking zone control in the area without the need for parking signs at each intersection (if any) within the area, having regard to:
- (a) the nature of the area; and
 - (b) the nature of the parking zone control; and
 - (c) traffic patterns into and within the area; and
 - (d) the nature and number of entry points to the area; and
 - (e) any other factor present that would influence a reasonable person's understanding of the parking control in the area.
- 12.4(13B) A road controlling authority, when declaring an area to be a parking zone:
- (a) may prohibit or restrict parking to a specified class or description of vehicle or road user; and
 - (b) may permit parking within the area subject to payment of a fee, or with a time restriction, or both.
- 12.4(14) The parking zone controls do not apply to an area that has a no stopping restriction, or is a loading zone, reserved parking area or time-restricted parking area, where these occur within a parking zone.
- 12.4(15) The road controlling authority must indicate a parking zone by providing, in accordance with *12.5*, appropriate signs that comply with *Schedule 1* and that specify the nature of the parking restriction.

Clause 12.4(1A): inserted, on 1 April 2011, by *clause 2.19(1)* of *Land Transport Rule: Traffic Control Devices Amendment 2010*.

Clause 12.4(5): replaced, on 1 April 2011, by *clause 2.19(2)* of *Land Transport Rule: Traffic Control Devices Amendment 2010*.

Clause 12.4(5)(a): amended, on 1 June 2019, by *clause 2.8(1)* of *Land Transport Rule: Traffic Control Devices Amendment 2019*.

Clause 12.4(5A): inserted, on 1 April 2011, by *clause 2.19(3)* of *Land Transport Rule: Traffic Control Devices Amendment 2010*.

Clause 12.4(9): amended, on 1 June 2019, by *clause 2.8(2)* of *Land Transport Rule: Traffic Control Devices Amendment 2019*.

Clause 12.9: amended, on 1 January 2014, by *clause 2.5(1)* of *Land Transport Rule: Traffic Control Devices Amendment 2013*.

Clause 12.4(9): replaced, on 1 April 2011, by *clause 2.19(4)* of *Land Transport Rule: Traffic Control Devices Amendment 2010*.

Clause 12.4(9A): inserted, on 1 April 2011, by *clause 2.19(5)* of *Land Transport Rule: Traffic Control Devices Amendment 2010*.

Clause 12.4(12): inserted, on 1 April 2011, by *clause 2.19(6)* of *Land Transport Rule: Traffic Control Devices Amendment 2010*.

Clause 12.4(13): replaced, on 1 June 2019, by *clause 2.8(3)* of *Land Transport Rule: Traffic Control Devices Amendment 2019*.

Clause 12.4(13): amended, on 1 January 2014, by *clause 2.5(2)* of *Land Transport Rule: Traffic Control Devices Amendment 2013*.

Clause 12.4(13A): inserted, on 1 June 2019, by *clause 2.8(3)* of *Land Transport Rule: Traffic Control Devices Amendment 2019*.

Clause 12.4(13B): inserted, on 1 June 2019, by *clause 2.8(3)* of *Land Transport Rule: Traffic Control Devices Amendment 2019*.

Clause 12.4(14): amended, on 1 June 2019, by *clause 2.8(4)* of *Land Transport Rule: Traffic Control Devices Amendment 2019*.

Clause 12.4(14): replaced, on 1 April 2011, by *clause 2.19(7)* of *Land Transport Rule: Traffic Control Devices Amendment 2010*.

Clause 12.4(15): amended, on 1 June 2019, by *clause 2.8(5)* of *Land Transport Rule: Traffic Control Devices Amendment 2019*.

Clause 12.4(15): inserted, on 1 April 2011, by *clause 2.19(7)* of *Land Transport Rule: Traffic Control Devices Amendment 2010*.

12.5

General requirements for signing parking restrictions

12.5(1)

Except as provided in *12.5(2)*, *12.5(3)* and *12.5(4)*, a road controlling authority must indicate a parking restriction, other than a parking zone control in a parking zone, by providing parking signs, as specified in *Schedule 1* and, if appropriate, with arrows or supplementary notices, defining their area or time of application:

- (a) at each end of the section of roadway affected; and
- (b) at or near both sides of any intervening intersection; and
- (c) at distances of not more than 100 m between any two signs.

- 12.5(2) Where a road controlling authority has indicated the extent of a loading zone (except for a bus stop), reserved parking area or time-restricted parking area by means of markings, as described in 12.4(5A), 12.4(9) or 12.4(12), it may, instead of complying with 12.5(1), indicate that parking restriction by providing parking signs, as specified in *Schedule 1* and, if appropriate, with arrows or supplementary notices, defining their area or time of application:
- (a) within the area and close to the end of the area furthest from an approaching driver; and
 - (b) at distances of not more than 200 m between any two signs.
- 12.5(2A) Where a road controlling authority has indicated the extent of a bus stop in accordance with 12.4(4)(a), the road controlling authority may, instead of complying with 12.5(1), indicate that bus stop:
- (a) by providing signs as specified in *Schedule 1* and, if appropriate, with arrows or supplementary notices, defining their area or time of application:
 - (i) within the area and close to the end of the area furthest from an approaching driver; and
 - (ii) at distances of not more than 200 m between any two signs; and
 - (b) if the bus stop is longer than 30 m in total, by marking on the area of roadway designated as a bus stop the words 'BUS STOP' conforming with the specifications in figure M3-2 or M3-2A.
- 12.5(3) A road controlling authority must indicate the extent of a parking zone by providing signs, that indicate the nature of the parking restriction and that include the word 'Zone':
- (a) where the zone starts with the words 'Zone Begins'; and
 - (b) where the zone ceases and no other parking zone control in a parking zone applies with the words 'Zone Ends'; and
 - (c) within the zone:
 - (i) at intervals sufficient to notify road users, but not more than 200 m apart unless the zone is interrupted for more than 200 m by an area subject to a different restriction; and
 - (ii) after an area where a different restriction applies.

- 12.5(4) A road controlling authority does not have to provide signs to indicate a restriction on parking, or the extent of the restriction, if parking is controlled by parking machines that are located at, or immediately adjacent to, each vehicle parking space.
- 12.5(5) Where a parking machine controls a parking space or spaces, the fees, time limits and any other restrictions, that apply on that day to the parking space or spaces, must be displayed on or next to the parking machine.
- 12.5(6) More than one but no more than four parking signs, or a special vehicle lane sign and no more than three parking signs, may be erected on the same pole or in the same location on the same building, wall or fence, provided that the signs and the order in which they appear conform with the specifications contained in series *R6 Parking signs* in *Schedule 1*.

Clause 12.5(1): amended, on 1 June 2019, by *clause 2.9(1) of Land Transport Rule: Traffic Control Devices Amendment 2019*.

Clause 12.5(1): replaced, on 1 April 2011, by *clause 2.20 of Land Transport Rule: Traffic Control Devices Amendment 2010*.

Clause 12.5(2): amended, on 1 June 2019, by *clause 2.9(2) of Land Transport Rule: Traffic Control Devices Amendment 2019*.

Clause 12.5(2): amended, on 1 November 2014, by *clause 2.6 of Land Transport Rule: Traffic Control Devices Amendment 2014*.

Clause 12.5(2): replaced, on 1 April 2011, by *clause 2.20 of Land Transport Rule: Traffic Control Devices Amendment 2010*.

Clause 12.5(2A): inserted, on 1 June 2019, by *clause 2.9(3) of Land Transport Rule: Traffic Control Devices Amendment 2019*.

Clause 12.5(3): amended, on 1 June 2019, by *clause 2.9(4) of Land Transport Rule: Traffic Control Devices Amendment 2019*.

Clause 12.5(3)(b): amended, on 1 June 2019, by *clause 2.9(5) of Land Transport Rule: Traffic Control Devices Amendment 2019*.

Clause 12.5(3): replaced, on 1 April 2011, by *clause 2.20 of Land Transport Rule: Traffic Control Devices Amendment 2010*.

Clause 12.5(4): inserted, on 1 April 2011, by *clause 2.20 of Land Transport Rule: Traffic Control Devices Amendment 2010*.

Clause 12.5(5): inserted, on 1 April 2011, by *clause 2.20 of Land Transport Rule: Traffic Control Devices Amendment 2010*.

Clause 12.5(6): inserted, on 1 April 2011, by *clause 2.20 of Land Transport Rule: Traffic Control Devices Amendment 2010*.

12.6 Application of parking signs

- 12.6(1) A parking restriction that is indicated by a sign incorporating the letter ‘P’ or ‘P\$’ on the top of the sign, or that relates to a

loading zone, applies between the hours of 8 am and 6 pm on days other than public holidays, unless otherwise specified on the sign or on a supplementary sign.

- 12.6(2) The expression ‘other times’, or an expression that has a similar effect, on a parking sign means that the restriction applies only during the time specified, but does not apply during the times specified by an immediately adjacent sign that notifies a different time restriction.
- 12.6(3) Parking signs, other than those in 12.6(1) and 12.6(2), apply at all hours of the day and night, unless a time period is specified on the sign.
- 12.6(4) Parking signs installed by road controlling authorities must conform with the specification of series *R6 Parking signs* in *Schedule 1*.
- 12.6(5) The combination of words and symbols used on parking signs have the meanings defined in series *R6 Parking signs* in *Schedule 1*.

Clause 12.6(1): amended, on 1 April 2011, by *clause 2.21(1)* of *Land Transport Rule: Traffic Control Devices Amendment 2010*.

Clause 12.6(4): replaced, on 1 April 2011, by *clause 2.21(2)* of *Land Transport Rule: Traffic Control Devices Amendment 2010*.

Clause 12.6(5): inserted, on 1 April 2011, by *clause 2.21(2)* of *Land Transport Rule: Traffic Control Devices Amendment 2010*.

12.7 General requirements for marking parking restrictions

- 12.7(1) If a road controlling authority marks an area to indicate parking spaces or the angle at which vehicles must park or letters, numerals or symbols to indicate other details about the parking restriction, those markings must be white, except if the area is a loading zone or reserved parking, for which the markings must be yellow.
- 12.7(2) Despite 12.4(8) and 12.7(1), the colour of the markings indicating a parking space that is reserved for ‘residents permit parking’ may be white, unless the parking space is reserved for all hours of the day and night.

Clause 12.7: amended, on 1 January 2014, by *clause 2.6* of *Land Transport Rule: Traffic Control Devices Amendment 2013*.

Clause 12.7(2): inserted, on 1 November 2015, by *clause 2.4(2)* of *Land Transport Rule: Traffic Control Devices Amendment 2015*.

Section 13 Responsibilities, functions and powers

13.1 Responsibilities of road controlling authorities

13.1(1) A road controlling authority must comply with this rule when providing, installing, modifying or maintaining a traffic control device or roadway art installed in accordance with 5.6(1).

13.1(2) A road controlling authority must comply with an instruction given by the Agency under 13.8.

Clause 13.1(1): amended, on 30 August 2020, by clause 2.7(1) of *Land Transport Rule: Traffic Control Devices Amendment 2020*.

Clause 13.1(2): amended, on 1 August 2008, by Part 2 of Schedule 3 of the *Land Transport Management Amendment Act 2008*.

13.2 Responsibilities of rail access providers

A rail access provider must comply with this rule when installing, modifying, maintaining or removing a traffic control device that is within the area of a level crossing.

13.3 Responsibilities of operators of manually-controlled stop signs

An operator of a manually-controlled stop sign must comply with 11.7.

Clause 13.3: amended, on 1 June 2019, by clause 2.10(1) of *Land Transport Rule: Traffic Control Devices Amendment 2019*.

13.4 Responsibilities of Boards of Trustees

A person who is a member of a Board of Trustees must comply with 8.3 and 8.8.

13.5 Responsibilities of school patrols

A person who is a member of a school patrol must comply with 8.3.

13.6 Responsibilities of school wardens

A person who is a school warden must comply with 8.8.

13.6A Responsibilities of school bus operators

A person who is a school bus operator must ensure that 4.4(14) to (16) are complied with.

Clause 13.6A: inserted, on 6 October 2006, by clause 2.6 of *Land Transport Rule: Traffic Control Devices Amendment 2006*.

13.7 Responsibilities of all persons

A person must not:

- (a) unless that person is a member of the New Zealand Police, or is authorised by a road controlling authority or the Agency, install, modify, remove or obscure a traffic control device or roadway art installed in accordance with 5.6(1);
- (b) damage or otherwise interfere with a traffic control device;
- (c) mark or install, or allow to be marked or installed, on a road, or in or on a place that is visible from a road, a sign, device or object that appears to be a traffic control device but is not;
- (d) install a traffic control device that bears a logo, monogram, sign of sponsorship, sign indicating an association with a business, or any information other than that specified in this rule;
- (e) use any fluorescent or phosphorescent reflective material or lights in a manner that is inconsistent with 4.7.

Clause 13.7(a): amended, on 30 August 2020, by *clause 2.8(1)* of *Land Transport Rule: Traffic Control Devices Amendment 2020*.

Clause 13.7(a): amended, on 1 August 2008, by *Part 2* of *Schedule 3* of the *Land Transport Management Amendment Act 2008*.

13.8 Functions and powers of the Agency

- 13.8(1) The Agency may, by notice in writing, direct a road controlling authority to provide, modify, maintain or remove a traffic control device if:
- (a) the Agency considers this is necessary in the interests of the safe or efficient use of a road; or
 - (b) the traffic control device does not comply with this rule.
- 13.8(2) The Agency may, in accordance with 3.4(1), authorise a trial of a traffic control device that does not comply with this rule or other enactment.
- 13.8(3) The Agency may, in accordance with 4.2(8), direct that a temporary sign be removed or additional signs be installed.
- 13.8(4) The Agency may, in accordance with 4.4(4), authorise the installation and maintenance of a traffic sign that does not comply with this rule.

- 13.8(4A) The Agency may, in accordance with 5.7 and 5.8, exercise powers in relation to a marking that is roadway art for the purposes of 5.6(1), or that the road controlling authority or the Agency considers is roadway art for the purposes of 5.6(1).
- 13.8(5) The Agency may, in accordance with 9.5(2), approve the installation of an 'Exempt' sign.
- 13.8(6) The Agency may audit a road controlling authority for compliance with this rule and may specify matters to be addressed in the audit.

Heading to clause 13.8: amended, on 1 August 2008, by Part 2 of Schedule 3 of the *Land Transport Management Amendment Act 2008*.

Clause 13.8(1): amended, on 1 August 2008, by Part 2 of Schedule 3 of the *Land Transport Management Amendment Act 2008*.

Clause 13.8(2): amended, on 1 August 2008, by Part 2 of Schedule 3 of the *Land Transport Management Amendment Act 2008*.

Clause 13.8(3): amended, on 1 August 2008, by Part 2 of Schedule 3 of the *Land Transport Management Amendment Act 2008*.

Clause 13.8(4): amended, on 1 August 2008, by Part 2 of Schedule 3 of the *Land Transport Management Amendment Act 2008*.

Clause 13.8(4A): inserted, on 30 August 2020, by clause 2.9(1) of *Land Transport Rule: Traffic Control Devices Amendment 2020*.

Clause 13.8(5): amended, on 1 August 2008, by Part 2 of Schedule 3 of the *Land Transport Management Amendment Act 2008*.

Clause 13.8(6): amended, on 1 August 2008, by Part 2 of Schedule 3 of the *Land Transport Management Amendment Act 2008*.

13.9 Powers of the Police

- 13.9(1) A member of the New Zealand Police may install, modify, remove, or direct the removal of a traffic control device if:
- (a) public disorder exists or is imminent; or
 - (b) danger to any member of the public exists or is anticipated; or
 - (c) it is considered necessary in the interests of the safe or efficient use of a road.
- 13.9(2) A member of the New Zealand Police who installs, modifies, removes or directs the removal of a traffic control device under 13.9(1) must notify the road controlling authority of this as soon as is reasonably practicable.
- 13.9(3) A member of the New Zealand Police may, in accordance with 4.2(8), direct that a temporary sign be removed or that additional signs be installed.

Part 2

Definitions

Act means the *Land Transport Act 1998*.

Agency means the New Zealand Transport Agency established under section 93 of the *Land Transport Management Act 2003*.

Barrier means a traffic control device that is intended to prevent or discourage a vehicle from moving out of the section of roadway on which it is travelling.

Bollard means a short post installed in the road, especially as part of a traffic island.

Bus means a passenger service vehicle that has more than nine seating positions (including the driver's seating position).

Bus lane has the same meaning as in clause 1.6 of the Land Transport (Road User) Rule 2004.

Bus-only lane means a lane reserved for the use of buses only.

Carpool means a shared use of a vehicle by a driver and one or more passengers, usually for commuting to a similar or nearby destination including place of employment, business or educational facility.

Centre-line

- (a) in relation to any portion of a roadway not marked with a flush median, means one or more broken or solid lines of paint or raised studs (or any combination of those lines and studs) intended to separate opposing traffic;
- (b) in relation to any portion of a roadway marked with a flush median, means the longitudinal white line that forms the left side of the flush median as viewed by a driver facing forward.

Channel means to guide or direct into defined paths and to separate through, turning or opposing traffic.

Chicane means a device that channels traffic by means of a series of alternating turns designed to reduce traffic speed.

Clearway means a length of roadway over which a no-stopping parking restriction applies for the purpose of increasing the number of through traffic lanes or providing increased space to allow for the free movement of traffic during the period for which the clearway restriction applies.

Cycle

- (a) means a vehicle having at least two wheels and that is designed primarily to be propelled by the muscular energy of the rider; and
- (b) includes a power-assisted cycle.

Cycle lane means a longitudinal strip within a roadway designed for the passage of cycles.

Cycle path

- (a) means part of the road that is physically separated from the roadway that is intended for the use of cyclists, but which may be used also by pedestrians; and
- (b) includes a cycle track formed under *section 332* of the *Local Government Act 1974*.

Delineator means a traffic control device including a guide post, chevron board, bollard, barrel or barrier, that is placed on or beside a roadway to guide road users.

Driver means a person driving a vehicle; and includes the rider of an all-terrain vehicle, a motor cycle, a moped, a cycle, a mobility device or a wheeled recreational device.

Driveway means a place used or appearing to be used as a vehicle entrance to or exit from land fronting a roadway.

Edgeline means a marking used to indicate the far left or far right side of the roadway.

Electric vehicle has the same meaning as in clause 1.6 of the Land Transport (Road User) Rule 2004.

Emergency services personnel means any member of the New Zealand Police, a fire service or an ambulance service.

Flush median means a median marked in accordance with 7.4(2).

Footpath means a path or way principally designed for, and used by, pedestrians; and includes a footbridge.

Goods vehicle means a motor vehicle that is:

- (a) designed exclusively or principally for the carriage of goods; or
- (b) used for the collection or delivery of goods in the course of trade.

Heavy vehicle lane means a lane reserved for the use of heavy vehicles by a marking or sign installed:

- (a) at the start of the lane; and
- (b) at each point at which the lane resumes after an intersection.

Intersection

- (a) in relation to two or more intersecting or meeting roadways, means that area contained within the prolongation or connection of the lateral boundary lines of each roadway; but

- (b) if two roadways are separated only by a traffic island or by a median less than 10 m wide, the roadways must be regarded as one roadway.

Lane

- (a) means a longitudinal strip of roadway that is intended for the passage of vehicles or a specific class of vehicle that is separated from other parts of the roadway by a longitudinal line or lines of paint or raised studs; and
- (b) includes:
 - (i) a cycle lane; and
 - (ii) a lane for the use of vehicular traffic that is at least 2.5 m wide; and
 - (iii) a lane of a two-way road divided by a centre-line.

Left side in relation to a vehicle, means its side to the left of the vehicle when the vehicle is facing forward.

Level crossing

- (a) means a place where:
 - (i) a railway line crosses a road or street on the same level; or
 - (ii) the public is permitted to cross a railway line on the same level; and
- (b) includes a bridge used for both rail vehicles and road traffic on the same level; but
- (c) does not include a railway line on a road that is intended solely for the use of light-rail vehicles.

Light-rail vehicle

- (a) means a rail vehicle that is designed to run along a road among other road vehicles and users; and
- (b) includes a tram; but
- (c) does not include:
 - (i) a rail vehicle approaching or on a level crossing; or
 - (ii) a rail vehicle while it is on a railway line that is not on a road.

Light-rail vehicle lane means a lane reserved for the use of light-rail vehicles by a marking or sign installed:

- (a) at the start of the lane (unless the light-rail vehicle lane is a continuous loop); and
- (b) at each point at which the lane resumes after an intersection.

Limit line means a line marked on the surface of the roadway to indicate the place where traffic is required to stop for the purpose of complying with a stop sign, give-way sign, pedestrian crossing, school crossing point or traffic signal.

Local authority means a regional council, a district council, a county council or a city council.

Loading zone means an area of marked roadway designated solely for the purpose of loading or unloading goods or passengers.

Lower risk environment has the meaning given by 5.6(2)

Marking means a line, symbol, pattern, message, numeral, pavement marker or other device set in the roadway or applied or attached to the road surface.

Median means a strip of land that may be part of a road and that separates vehicles travelling in opposite directions.

Mid-block pedestrian traffic signal means a pedestrian traffic signal that is not located at an intersection.

Motor home means a motor vehicle that is permanently fitted out for accommodation by the inclusion of sleeping and cooking facilities and must have more than half of the vehicle floor area (including the floor area of both tractor and trailer if a combination vehicle) fitted out for accommodation.

Motor vehicle has the same meaning as in *section 2(1)* of the Act.

Nearside pedestrian traffic signal means a pedestrian traffic signal installed on the same side of a road as the pedestrian is crossing from.

Normal braking means the level of braking applied to a vehicle that does not lock any of the vehicle's wheels and permits the vehicle to decelerate without adversely affecting directional control.

Normal vision means the visual acuity required of a person to obtain and hold a driver licence, in accordance with the *Land Transport (Driver Licensing) Rule 1999*.

Parking means:

- (a) in relation to any portion of a road where parking is for the time being governed by the location of parking machines placed under a bylaw of a local authority, the stopping or standing of a vehicle on that portion of the road for any period exceeding five minutes;
- (b) in relation to any other portion of a road, the stopping or standing of a vehicle (other than a vehicle picking up or setting down passengers in a loading zone or reserved parking area, and entitled to do so) on that portion of the road.

Parking machine means a parking meter or other device that is used to collect payment in exchange for parking a vehicle in a particular place for a limited time.

Parking zone control means any control on parking imposed by a road controlling authority when declaring an area to be a parking zone under *12.4(13)*.

Passenger service vehicle has the same meaning as in *section 2(1)* of the Act.

Pedestrian

- (a) means a person on foot on a road; and
- (b) includes a person in or on any contrivance equipped with wheels or revolving runners that is not a vehicle.

Pedestrian crossing means a pedestrian crossing duly established and marked on a roadway in accordance with 8.2.

Pedestrian traffic signals means traffic signals to control the movement of pedestrians crossing the roadway.

Power-assisted cycle means a cycle to which is attached one or more auxiliary propulsion motors that have a combined maximum power output not exceeding 300 watts.

Public holiday means the following days:

- (a) Christmas Day;
- (b) Boxing Day;
- (c) if Christmas Day falls on a Friday, the following Monday;
- (d) if Christmas Day falls on a Saturday or a Sunday, the following Monday and Tuesday;
- (e) New Year's Day;
- (f) 2 January;
- (g) if New Year's Day falls on a Friday, the following Monday;
- (h) if New Year's Day falls on a Saturday or a Sunday, the following Monday and Tuesday;
- (i) Waitangi Day;
- (j) if Waitangi Day falls on a Saturday or a Sunday, the following Monday;
- (k) Good Friday;
- (l) Easter Sunday;
- (m) Easter Monday;
- (n) Anzac Day;
- (o) if Anzac Day falls on a Saturday or a Sunday, the following Monday;
- (p) the birthday of the reigning Sovereign (observed on the first Monday in June);
- (q) Labour Day (being the fourth Monday in October);
- (r) the day of the anniversary of a province or the day locally observed as that day.

Rail access provider in relation to a railway line, means the person who controls the use of the railway line by rail operators (including that person if it is also a railway operator) whether or not that person engages an employee, agent, contractor or volunteer to exercise or assist in exercising control on its behalf; but does not include those individuals.

Rail vehicle

- (a) means any vehicle that operates on, or uses, a railway line; and
- (b) includes a locomotive, rail carriage, rail wagon, railcar, light-rail vehicle, rail maintenance vehicle (whether or not self-propelled), and any other vehicle prescribed as a rail vehicle by any enactment; but
- (c) does not include a vehicle designed to operate both on and off rails while it is not operating on rails.

Reflective material (or retroreflective material) means any material that is designed to reflect incident light back towards the light source, or in a specific direction; but does not include a reflector.

Reserved parking means an area of roadway reserved for parking by a specified class or classes of vehicle or class or classes of road user, or for a specified purpose.

Rider means a person riding an animal, an all-terrain vehicle, a motorcycle, a moped, a cycle, a mobility device or a wheeled recreational device.

Right side in relation to a vehicle, means its side to the right of the vehicle when the vehicle is facing forward.

Road includes:

- (a) a street; and
- (b) a motorway; and
- (c) a beach; and
- (d) a place to which the public have access, whether as of right or not; and
- (e) all bridges, culverts, ferries and fords forming part of a road or street or motorway, or a place referred to in (d); and
- (f) all sites at which vehicles may be weighed for the purposes of the Act or any other enactment.

Road controlling authority in relation to a road:

- (a) means the authority, body, or person having control of the road; and
- (b) includes a person acting under and within the terms of a delegation or authorisation given by the controlling authority.

Road hump means a short, elevated portion of roadway used as a means of reducing the speed of vehicles travelling on the roadway.

Road user means a driver, rider, passenger or pedestrian.

Roadway means that portion of the road used or reasonably usable for the time being for vehicular traffic in general.

Roundabout means an intersection with one or more marked lanes or lines of traffic, all of which are for the use of vehicles travelling in a clockwise direction around a central traffic island.

Safe stopping distance means the minimum distance required for a driver of normal vision, driving at a safe operating speed for the road, to recognise a hazard and decelerate with normal braking to stop completely before reaching the hazard.

Safety zone means a portion of roadway:

- (a) indicated by a structure installed on the roadway; and
- (b) that has, near the end first met by approaching vehicles travelling along the side of the roadway on which the safety zone is established, a device displaying to approaching drivers the words 'Safety Zone'.

School bus

- (a) means a bus that is being used, whether or not for hire or reward:
 - (i) for transporting school children to or from school with or without their teachers; or
 - (ii) principally for transporting school children to or from a school function; but
- (b) does not include a bus that:
 - (i) is being used principally for transporting school children to or from a school function; and
 - (ii) is carrying no more passengers than the seated capacity specified in the bus's certificate of loading; and
 - (iii) is not displaying a 'School bus' sign.

Shared path means an area of road, separated from a roadway, that may be used by some or all of the following persons at the same time: pedestrians, cyclists, riders of mobility devices and riders of wheeled recreational devices.

Shoulder means any part of a road not designed to be used by motor vehicles in travelling along the road and, on a sealed road, includes:

- (a) any unsealed part of the road; and
- (b) any sealed part of the road outside an edgeline on the road.

Special route means a roadway or a series of linked roadways which vehicles of a specified class or classes are required or encouraged to use.

Special vehicle lane means a lane defined by signs or markings and restricted to a specified class or classes of vehicle; and includes a bus lane, a transit lane, a cycle lane, and a light-rail vehicle lane.

Standing means stopping:

- (a) for the purpose of picking up or setting down passengers, or, in the case of a small passenger service vehicle stand, for the purposes of waiting for hire; and
- (b) while a vehicle remains attended by the driver at all times.

Supplementary sign, plate or notice means a sign, plate or notice installed below or in combination with another sign to provide additional information that relates directly to the content of the other sign, and that has no clear independent meaning.

Temporary traffic signals means traffic signals that are installed for the temporary control of traffic.

Traffic calming device means a device that is intended, generally in association with other traffic control devices, to moderate the volumes or speeds of traffic in an area so they are consistent with the road environment and its use.

Traffic control device

- (a) means a device used on a road for the purpose of traffic control; and
- (b) includes any:
 - (i) sign, signal, or notice; or
 - (ii) traffic calming device; or
 - (iii) marking or road surface treatment; but
- (c) does not include roadway art installed in accordance with 5.6(1).

Traffic island means a defined area within a roadway, which may be flush with the roadway or raised, and from which vehicular traffic is intended to be excluded.

Traffic sign means a board, plate, screen or other device, whether or not illuminated, displaying words, figures, symbols or other material intended to instruct, advise, inform or guide traffic on a road; and includes a 'children crossing' flag, a manually-controlled stop sign, a parking control sign and variable message signs; but does not include a traffic signal.

Traffic signal means a set of illuminated displays complying with *section 6* and that are steady, flashing or pedestrian displays.

Traffic signal controller means the equipment and programming associated with it that controls the duration and sequence of signal displays.

Transit lane has the same meaning as in clause 1.6 of the Land Transport (Road User) Rule 2004.

Turn bay means an area of roadway that is reserved for vehicles making, or waiting to make, a turn.

Vehicle has the same meaning as in *section 2(1)* of the Act.

Visible means able to be seen from a safe stopping distance.

Wheeled recreational device:

- (a) means a vehicle that is a wheeled conveyance (other than a cycle that has a wheel diameter exceeding 355 mm) and that is propelled by human power or gravity; and
- (b) includes a conveyance to which are attached one or more auxiliary propulsion motors that have a combined maximum power output not exceeding 300 W.

Wide centre-lines means the marking described in *7.2A(2)*.

Zone restriction means an area of roadway the use of which is restricted (with or without a time restriction) to:

- (a) a specified class or classes of vehicle; or
- (b) a specified class or classes of road user.

Part 2, Definitions, Agency: inserted, on 1 August 2008, by *Part 2 of Schedule 3 of the Land Transport Management Amendment Act 2008*.

Part 2, Definitions, bus lane: replaced, on 1 September 2017, by *clause 6(2) of Land Transport Rule: Traffic Control Devices Amendment 2017*.

Part 2, Definitions, bus lane, paragraph (b): amended, on 1 November 2014, by *clause 3.1(1) of Land Transport Rule: Traffic Control Devices Amendment 2014*.

Part 2, Definitions, bus lane, paragraph (b): replaced, on 15 September 2005, by *clause 3.2(1) of Land Transport Rule: Traffic Control Devices Amendment 2005*.

Part 2, Definitions, bus-only lane: inserted, on 1 June 2019, by *clause 2.11(4) of Land Transport Rule: Traffic Control Devices Amendment 2019*.

Part 2, Definitions, Carpool: inserted, on 1 April 2011, by *clause 3.1 of Land Transport Rule: Traffic Control Devices Amendment 2010*.

Part 2, Definitions, Director: revoked, on 1 August 2008, by *Part 2 of Schedule 3 of the Land Transport Management Amendment Act 2008*.

Part 2, Definitions, Driveway: inserted, on 1 April 2011, by *clause 3.1 of Land Transport Rule: Traffic Control Devices Amendment 2010*.

Part 2, Definitions, electric vehicle: inserted, on 1 September 2017, by *clause 6(1) of Land Transport Rule: Traffic Control Devices Amendment 2017*.

Part 2, Definitions, Emergency services personnel: amended, on 1 May 2021, by *clause 2.3(1) of Land Transport Rule: Traffic Control Devices Amendment 2021*.

Part 2, Definitions, **heavy vehicle lane**: inserted, on 1 June 2019, by clause 2.11(4) of Land Transport Rule: Traffic Control Devices Amendment 2019.

Part 2, Definitions, **light-rail vehicle**: replaced, on 15 September 2005, by clause 3.1 of Land Transport Rule: Traffic Control Devices Amendment 2005.

Part 2, Definitions, **light-rail vehicle lane**: replaced, on 1 November 2015, by clause 2.5 of Land Transport Rule: Traffic Control Devices Amendment 2015.

Part 2, Definitions, **Lower risk environment**: inserted, on 30 August 2020, by clause 2.10(1) of Land Transport Rule: Traffic Control Devices Amendment 2020.

Part 2, Definitions, **Mid-block pedestrian traffic signal**: inserted, on 1 April 2011, by clause 3.1 of Land Transport Rule: Traffic Control Devices Amendment 2010.

Part 2, Definitions, **Motor home**: inserted, on 1 April 2011, by clause 3.1 of Land Transport Rule: Traffic Control Devices Amendment 2010.

Part 2, Definitions, **Nearside pedestrian traffic signal**: inserted, on 1 April 2011, by clause 3.1 of Land Transport Rule: Traffic Control Devices Amendment 2010.

Part 2, Definitions, **Parking**: amended, on 1 April 2011, by clause 3.2(1) of Land Transport Rule: Traffic Control Devices Amendment 2010.

Part 2, Definitions, **Parking machine**: inserted, on 1 April 2011, by clause 3.1 of Land Transport Rule: Traffic Control Devices Amendment 2010.

Part 2, Definitions, **parking zone control**: inserted, on 1 June 2019, by clause 2.11(4) of Land Transport Rule: Traffic Control Devices Amendment 2019.

Part 2, Definitions, **passenger service vehicle**: amended, on 6 October 2006, by clause 3.1(1) of Land Transport Rule: Traffic Control Devices Amendment 2006.

Part 2, Definitions, **power-assisted cycle**: amended, on 6 October 2006, by clause 3.1(2) of Land Transport Rule: Traffic Control Devices Amendment 2006.

Part 2, Definitions, **Public holiday**: replaced, on 1 May 2021, by clause 2.3(2) of Land Transport Rule: Traffic Control Devices Amendment 2021.

Part 2, Definitions, **Rider**: inserted, on 1 April 2011, by clause 3.1 of Land Transport Rule: Traffic Control Devices Amendment 2010.

Part 2, Definitions, **School bus**: replaced, on 1 January 2014, by clause 3.1 of Land Transport Rule: Traffic Control Devices Amendment 2013.

Part 2, Definitions, **Shared path**: inserted, on 1 April 2011, by clause 3.1 of Land Transport Rule: Traffic Control Devices Amendment 2010.

Part 2, Definitions, **Standing**: amended, on 1 October 2017, by Part 5 of Schedule 3 of Land Transport Amendment Act 2017.

Part 2, Definitions, **Supplementary sign, plate or notice**: inserted, on 1 April 2011, by clause 3.1 of Land Transport Rule: Traffic Control Devices Amendment 2010.

Part 2, Definitions, **Traffic control device**: replaced, on 30 August 2020, by clause 2.10(2) of Land Transport Rule: Traffic Control Devices Amendment 2020.

Part 2, Definitions, **traffic sign**: amended, on 1 June 2019, by clause 2.11(2) of Land Transport Rule: Traffic Control Devices Amendment 2019.

Part 2, Definitions, **transit lane**: replaced, on 1 September 2017, by clause 6(3) of Land Transport Rule: Traffic Control Devices Amendment 2017.

Part 2, Definitions, **transit lane**, paragraph (e): inserted, on 15 September 2005, by clause 3.2(2) of Land Transport Rule: Traffic Control Devices Amendment 2005.

Part 2, Definitions, **Wheeled recreational device**: inserted, on 1 April 2011, by clause 3.1 of Land Transport Rule: Traffic Control Devices Amendment 2010.

Part 2, Definitions, **Wide centre-lines**: inserted, on 1 January 2014, by clause 3.2 of Land Transport Rule: Traffic Control Devices Amendment 2013.

Part 2, Definitions, **Zone parking**: revoked, on 1 June 2019, by clause 2.11(1) of Land Transport Rule: Traffic Control Devices Amendment 2019.

Part 2, Definitions, **Zone restriction**: replaced, on 1 June 2019, by clause 2.11(3) of Land Transport Rule: Traffic Control Devices Amendment 2019.

Part 2, Definitions, **Zone restriction**: amended, on 1 January 2014, by clause 3.3 of Land Transport Rule: Traffic Control Devices Amendment 2013.

Part 3 Schedules

Schedule 1

Signs

- All measurements are shown in millimetres, unless otherwise indicated.
- The letter 'R' after a colour indicates that the colour must either be made of retroreflective material or be internally or externally illuminated so as to be clearly visible to approaching drivers.
- The letter 'F' after a colour indicates that the colour must be fluorescent.
- The letter 'f' after a colour indicates that the colour may be fluorescent.
- When, after a colour, the letters 'R', 'F' or 'f' are combined (for example, 'RF' or 'Rf') each individual letter retains its individual meaning as provided above.
- The size of lettering and numerals is shown by two figures separated by a diagonal slash. The first figure is the letter height in millimetres and the second figure is stroke width in millimetres.
- All red diagonal bars are sloping 45° from top left to bottom right unless otherwise specified.
- The word 'rural' after the name or description of a sign indicates that the sign is used on roads having a speed limit that is a Limited Speed Zone or is at least 70 km/h.
- The word 'urban' after the name or description of a sign indicates that the sign is used on roads having a speed limit that is less than 70 km/h.
- The word 'shaft' with a dimension refers to shaft-width of an arrow having a head-length and -width at least twice the shaft-width.
- 'Tpt Med' means the typeface used is Transport Medium.
- The words 'lit' and 'unlit' refer to the state of the lighting devices used to display the message on the sign.
- The word 'effective' is used where the message is lit and describes the effective width of the lighting, which is generally wider than the spacing or diameter of the lighting devices used.
- The size of a symbol is shown as width x height.
- Within the described 'shape and size', the corners of signs may be rounded.
- A traffic control device that conforms substantially with the form of a traffic control device prescribed in this Schedule is deemed to be an authorised traffic control device.

Regulatory signs

R1 Speed limit signs

R1-1	Standard		
	<i>Highest speed limit is the number of km/h shown on the sign.</i>		
Shape and size	circle 600 mm diameter		
Background	white (R)		
Border	red (R) 75 mm		
Legend	Description	Colour	Size
	'[speed limit in km/h]'	black	200/31
R1-1.1	100 km/h		
	<i>Highest speed limit is 100 km/h.</i>		
Shape and size	circle 600 mm diameter		
Background	white (R)		
Border	red (R) 75 mm		
Legend	Description	Colour	Size
	'100'	black	200/28
R1-1.2	110 km/h		
	<i>The speed limit is 110 km/h.</i>		
Shape and size	circle 600 mm diameter		
Background	white (R)		
Border	red (R) 75 mm		
Legend	Description	Colour	Size
	'110'	black	200/32
R1-2	Variable speed		
	<i>Highest speed limit is the number of km/h shown on the sign.</i>		
Shape and size	rectangle 800 x 800 mm		
Background	white (R)		
Border	None		
Legend	Description	Colour	Size
- sign	R1-1 sign with a changeable speed value	red (R)	circle 600 mm diameter
- option	optional lights in each corner, which may flash in alternate diagonal pairs	yellow or white when lit	effective 90 mm diameter circles

R1-2.1		Variable speed	
<i>Highest speed limit is the number of km/h shown on the sign.</i>			
Shape and size	rectangle 800 x 800 mm		
Background	black (unlit)		
Border	None		
Legend	Description	Colour	Size
- sign	R1-1 with a changeable speed value	roundel red (lit) or red (R)	600 mm diameter (effective) 90 mm roundel width
		numerals yellow (lit) or white (lit)	200/31 (effective) (numeral size may be increased up to 25%)
- option A	optional lights in each corner, which may flash in alternate diagonal pairs	yellow or white when lit	90 mm diameter (effective) circles
- option B	when the roundel comprises two or more concentric rings of illuminated elements, the outer ring must be continuously lit, but the inner rings may flash at approximately 1 Hertz	red when lit	outer ring 600 mm diameter (effective), inner rings sized to achieve a 90 mm roundel width
R1-3		Derestriction	
<i>Highest speed limit is 100 km/h.</i>			
Shape and size	circle 600 mm diameter		
Background	white (R)		
Border	None		
Legend	Description	Colour	Size
	bar sloping from top right to bottom left	black	150 mm wide
R1-4		<i>(Revoked)</i>	
R1-5		Speed limit with locality	
<i>Highest speed limit is the number of km/h shown on the sign; combined with name of locality reached.</i>			
Shape and size	R1-1 speed limit sign above an A17-1 locality sign		

R1-5.1		Urban/urban threshold	
<i>Highest speed limit is the number of km/h shown on the sign; combined with name of locality reached. Three options.</i>			
Shape and size	rectangle 900 x 1200 mm		
Option A			
Background	green (R) or blue (R)		
Border	white (R) 30 mm		
Legend	Description	Colour	Size
	R1-1 above	black, red (R) and white (R)	as for R1-1
	'[locality]'	white (R)	75/19
Option B			
Background	White		
Border	Black		
Legend	Description	Colour	Size
	R1-1 above	black, red (R) and white (R)	as for R1-1
	'[locality]'	black	75/19
Option C			
Background	Black		
Border	white (R) 30 mm		
Legend	Description	Colour	Size
	R1-1 above	black, red (R) and white	as for R1-1
	'[locality]'	white (R)	75/19

R1-5.2		Rural threshold	
<i>Highest speed limit is the number of km/h shown on the sign; combined with name of locality reached. Three options.</i>			
Shape and size	rectangle 1900 x 2700 mm		
<i>Option A</i>			
Background	green (R) or blue (R)		
Border	white (R) 30 mm		
Legend	Description	Colour	Size
	R1-1 above optional	black, red (R) and white (R)	as for R1-1
	‘WELCOME’	white (R)	100/15.5
	‘TO’ above	white (R)	100/15.5
	‘[locality]’	white (R)	160/40
<i>Option B</i>			
Background	White		
Border	Black		
Legend	Description	Colour	Size
	R1-1 above optional	black, red (R) and white (R)	as for R1-1
	‘WELCOME’	black	100/15.5
	‘TO’ above	black	100/15.5
	‘[locality]’	black	160/40
<i>Option C</i>			
Background	Black		
Border	white (R) 30 mm		
Legend	Description	Colour	Size
	R1-1 above optional	black, red (R) and white (R)	as for R1-1
	‘WELCOME’	white (R)	100/15.5
	‘TO’ above	white (R)	100/15.5
	‘[locality]’	white (R)	160/40

R1-5.3		Motorway ends threshold	
<i>Highest speed limit is the number of km/h shown on the sign and advises the motorway, with the special road rules that apply, ends.</i>			
Shape and size	rectangle 900 x 1200 mm		
Background	green (R)		
Border	white (R) 30 mm		
Legend	Description	Colour	Size
	as for R1-1	black, red (R) and white (R)	as for R1-1
	with border	white (R)	20 mm
	above		
	‘MOTORWAY’	white (R)	120/16.8
	‘ENDS’	white (R)	120/16.8
R1-5.4		Motorway begins threshold	
<i>Highest speed limit is the number of km/h shown on the sign, advises the named motorway begins and informs that pedestrians and cycles are not permitted beyond the sign.</i>			
Shape and size	rectangle 1200 x 1600 mm		
Background	green (R)		
Border	white (R) 30 mm		
Legend	Description	Colour	Size
	as for R1-1	black, red (R) and white (R)	as for R1-1
	with border	white (R)	30 mm
	above		
	‘[motorway name]’	white (R)	120/16.8
	‘MOTORWAY’ above	white (R)	120/16.8
	R5-2 ‘no pedestrian’ beside	black, red (R) and white (R)	as for R5-2
	R5-1 ‘no cycling’	black, red (R) and white (R)	as for R5-1
R1-5.5		Safer Speed Area Threshold	
<i>The speed limit shown on the sign has been set in accordance with Safe System principles and applies to the roads in the area beyond the sign.</i>			
Shape and size	rectangle 750 x 1200 mm (approach speed < 60 km/h)		
	900 x 1500 mm (approach speed 60 – 80 km/h)		
	1200 x 1900 mm (approach speed > 80 km/h)		

Background	blue (R) or green (R)		
Border	white (R) 30 mm		
Legend	Description	Colour	Size
	R1-1	white (R), red (R) and black	As for R1-1
	above		600 mm diameter (approach speed < 60 km/h)
			750 mm diameter (approach speed 60 – 80 km/h)
	“Safer”	white (R)	900 mm diameter (approach speed > 80 km/h)
	“Speed”		100/20 upper case
	“Area”		75/19 lower case (approach speed < 60 km/h)
			120/24 upper case 90/22.5 lower case (approach speed 60 – 80 km/h)
			160/32 upper case 120/30 lower case (approach speed > 80 km/h)

R1-5.6	Motorway or expressway threshold		
	<i>The speed limit is the number of km/h shown on the sign and optionally advises the name of the motorway or expressway or locality.</i>		
Shape and size	Rectangle, at least 900 x 1200 mm or larger as necessary to fit the speed limit sign and the motorway, expressway or locality name. The width to height ratio of the sign must be between 1:1.2 and 1:1.7.		
Background	green (R)		
Border	white (R) 25 mm		
Legend	Description	Colour	Size
	R1-1, R1-1.1 or R1-1.2	White (R), red (R) and black	As for R1-1, R1-1.1 or R1-1.2 600 mm diameter
	with border,		
	above		
	Optional ‘[Motorway name]’ or ‘[Expressway name]’ or ‘[Locality]’ (mixed case text),	white (R)	120/19.2
	above		

	Optional 'Motorway' or 'Expressway'	white (R)	120/19.2
R1-6	School zone variable		
	<i>Highest speed limit is the number of km/h shown on the sign that applies to a school zone.</i>		
Shape and size	R1-2 or R1-2.1 sign (background, border, legend as for R1-2 or R1-2.1), above a 'School Zone' supplementary sign		
	'School Zone' supplementary sign		
Shape and size	rectangle 750 x 550 mm		
Background	yellow-green (RF)		
Border	black 20 mm		
Legend	Description	Colour	Size
	'SCHOOL'	black	125/19.5
	'ZONE'	black	125/19.5

R1-6.1	School zone fixed		
	<i>Highest speed limit is the number of km/h shown on the sign that applies to a school zone during the time specified. Must only be used on No exit or Give-way or Stop sign controlled side roads adjacent to the school zone signed by R1-6 signs.</i>		
Shape and size	rectangle 860 x 1500 mm		
Background	white (R)		
Border	red (R) 30 mm		
Legend	Description	Colour	Size
	'SCHOOL'	black	100/15.5
	'ZONE'	black	100/15.5
	R1-1 above, for example, '8:25 - 9 AM'	black, red (R) and white	as for R1-1
	'2:55 - 3:15 PM'	black	80/12.4
	'SCHOOL DAYS'	black	80/12.4

R1-7	School zone ends		
	<i>School zone speed limit ends and limit reverts to the permanent speed limit.</i>		
Shape and size	rectangle backing board 840 x 1500 mm (white (R) background) incorporating R1-1, 600 mm diameter sign (background, border and legend as for R1-1) above a 'School Zone Ends' supplementary sign		
	'School Zone Ends' supplementary sign		
Shape and size	rectangle 800 x 800 mm		

Background	yellow-green (RF)		
Border	black 30 mm		
Legend	Description	Colour	Size
	‘SCHOOL’	black	125/19.5
	‘ZONE’	black	125/19.5
	‘ENDS’	black	125/19.5

R1-8	Temporary speed limit		
	<i>Highest speed limit is the number of km/h shown on the sign.</i>		
Shape and size	R1-1, 600 mm diameter sign (background, border and legend as for R1-1) above a ‘Temporary’ supplementary sign		
	‘Temporary’ supplementary sign		
Shape and size	rectangle 900 x 300 mm		
Background	orange (RF)		
Border	black 15 mm		
Legend	Description	Colour	Size
	‘TEMPORARY’	black	100/14

R1-8.1	Temporary speed limit		
	<i>Highest speed limit is the number of km/h shown on the sign.</i>		
Shape and size	rectangle backing board, 1200 x 1200 mm (white background, black border, legend as for R1-1 (900 mm diameter)) above a ‘Temporary’ supplementary sign		
	‘Temporary’ supplementary sign		
Shape and size	rectangle 1200 x 400 mm		
Background	orange (RF)		
Border	black 20 mm		
Legend	Description	Colour	Size
	‘TEMPORARY’	black	175/24.5

R1-8.2	Temporary speed limit for slippery surface		
	<i>Combination R1-1 speed limit sign above a W3-2 slippery surface, temporary warning sign to advise drivers that the speed limit displayed is a temporary speed limit due to an unsafe, slippery road surface. Two options.</i>		
	Option A		
Shape and size	R1-1 speed limit sign: circle 750mm diameter above W3-2 temporary warning sign: diamond 750mm square		
Background	R1-1 speed limit sign: White (R)		

	W3-2 temporary warning sign: Orange (RF)		
Border	R1-1 speed limit sign: Red (R) 95mm W3-2 temporary warning sign: Black 25mm		
Legend	Description	Colour	Size
R1-1	‘[speed limit in km/h]’ Above	black	250/40
W3-2	‘[symbol of a car skidding]’	black	600mm x 550mm
Option B			
Shape and size	R1-1 speed limit sign on rectangle backing board 1200mm x 1200mm above W3-2 temporary warning sign on rectangle backing board 1200mm x 1200mm		
Background	Backing boards: White (R)		
Border	Black 30mm or may have no border		
Legend	Description	Colour	Size
	R1-1 speed limit sign above	White (R), red (R) R1-1 speed limit sign above	900mm or 1200mm diameter
	W3-2 slippery surface temporary warning	Orange (RF) and black, as for W3-2	Diamond 850mm square

R1-8.3 Temporary speed limit for Unsafe Structure

Combination R1-1 speed limit sign above a W1-1.13 bridge repairs, road works supplementary – bridge repairs sign to advise that the speed limit displayed is a temporary speed limit due to an unsafe structure. Two options.

Option A

Shape and size	R1-1 speed limit sign: circle 750 mm diameter above W1-1.13 road works supplementary: rectangle 900 x 450 mm		
Background	R1-1 speed limit sign: White (R) W1-1.13 road works supplementary – bridge repairs sign: Orange (RF)		
Border	R1-1 speed limit sign: Red (R) 95mm W1-1.13 road works supplementary sign: Black 25mm		
Legend	Description	Colour	Size
R1-1	‘[speed limit in km/h]’ above	black	250/40

W1-1.13			
Option B	‘BRIDGE’	black	120/19.2
Shape and size	‘REPAIRS’	black	120/19.2
Background			
	R1-1 speed limit sign on rectangle backing board 1200 x 1200 mm above		
	W1-1.13 road works supplementary – bridge repairs sign: rectangle 1200 x 600 mm		
Border	Backing boards: White (R)		
Legend	Black 30mm or may have no border		
	Description	Colour	Size
	R1-1 speed limit sign on rectangle backing board 1200mm x 1200mm above	White (R), red (R) R1-1 speed limit sign above	900mm or 1200mm diameter
	W1-1.13 road works supplementary – bridge repairs sign	Orange (RF) and black, as for W1-1.13	Rectangle 1200 x 600 mm

R2 Stop and give way

R2-1	Stop		
	<i>Meaning set out in clauses 4.1 and 4.2 of Land Transport (Road User) Rule 2004.</i>		
Shape and size	octagon 750 mm wide		
Background	red (R)		
Border	white (R) 25 mm		
Legend	Description	Colour	Size
	‘STOP’	white (R)	220/30.8

R2-2	Give way		
	<i>Meaning set out in clauses 4.1, 4.2 and 4.6 of Land Transport (Road User) Rule 2004.</i>		
Shape and size	equilateral triangle, sides 865 mm long		
Background	white (R)		
Border	red (R) 65 mm		
Legend	Description	Colour	Size
	‘GIVE’	red (R)	125/18

	'WAY'	red (R)	100/12.5
--	-------	---------	----------

R2-2.1 Give way – supplementary – 'locality' traffic

Supplementary sign to R2-2 Give way applies to traffic travelling toward the specified locality.

Shape and size rectangle 900 x 600 mm

Background white (R)

Border red (R) 20 mm

Legend	Description	Colour	Size
	'[locality]'	red (R)	150/21
	'TRAFFIC'	red (R)	150/21

R2-2.2 Give way – supplementary – straight-ahead traffic

Supplementary sign to R2-2 Give way applies to traffic travelling straight ahead.

Shape and size rectangle 900 x 800 mm

Background white (R)

Border red (R) 20 mm

Legend	Description	Colour	Size
	'STRAIGHT'	red (R)	150/19
	'AHEAD'	red (R)	150/21
	'TRAFFIC'	red (R)	150/21

R2-2.3 Give way – supplementary – right-turning traffic

Supplementary sign to R2-2 Give way applies to traffic making a right turn.

Shape and size rectangle 900 x 800 mm

Background white (R)

Border red (R) 20 mm

Legend	Description	Colour	Size
	'RIGHT'	red (R)	150/21
	'TURNING'	red (R)	150/21
	'TRAFFIC'	red (R)	150/21

R2-2.4 Give way – supplementary – left-turning traffic

Supplementary sign to R2-2. Give way applies to traffic making a left turn.

Shape and size rectangle 900 x 800 mm

Background white (R)

Border	red (R) 20 mm		
Legend	Description	Colour	Size
	‘LEFT’	red (R)	150/21
	‘TURNING’	red (R)	150/21
	‘TRAFFIC’	red (R)	150/21
R2-3	Give way roundabout		
	<i>Meaning set out in clause 4.6 of the Land Transport (Road User) Rule 2004.</i>		
Shape and size	equilateral triangle sides 865 mm long which may be mounted above an optional rectangle 600 x 250 mm		
Background	white (R)		
Border	triangle red (R) 65 mm, rectangle red (R) 15 mm		
Legend	Description	Colour	Size
	triangle: ‘symbol of 3 circulating arrows’	Black	shaft 37 mm
	rectangle: ‘GIVE WAY’ (optional)	red (R)	100/12.5
R2-2.5	Give way – supplementary – to cyclists		
	<i>Supplementary sign for R2-2. Reinforces requirement for drivers to give way to cyclists crossing the road on a priority controlled cycle path, in accordance with clause 4.1 of the Land Transport (Road User) Rule 2004 and subclause 11.4(5) of the Land Transport Rule: Traffic Control Devices 2004.</i>		
Shape and size	Rectangle 900 × 300mm		
Background	White (R)		
Border	Red (R) 20mm		
Legend	Description	Colour	Size
	“TO CYCLISTS”	red (R)	120/16.8
R2-2.6	Give way – supplementary – to cyclists and pedestrians		
	<i>Supplementary sign for R2-2. Reinforces requirement for drivers to give way to cyclists and pedestrians crossing the road on a priority controlled shared path, in accordance with clause 4.1 of the Land Transport (Road User) Rule 2004 and subclause 11.4(5) of the Land Transport Rule: Traffic Control Devices 2004.</i>		
Shape and size	Rectangle 900 × 450mm		
Background	White (R)		
Border	Red (R) 20mm		
Legend	Description	Colour	Size
	‘TO CYCLISTS &’	red (R)	120/15.6
	‘PEDESTRIANS’	red (R)	120/15.6

R2-3.1	Give-way roundabout variable		
	<i>Meaning set out in clause 4.6 of Land Transport (Road User) Rule 2004.</i>		
Shape and size	1200 x 1200 mm		
Background	black (unlit)		
Border	None		
Legend	Description	Colour	Size
	form of R2-3 sign	edge-line of triangle red (lit)	effective 65 mm wide
		arrows yellow (lit) or white (lit)	effective shaft 37 mm 100/12.5
		'GIVE WAY' yellow (lit) or white(lit)	effective 100/12.5
R2-4	School patrol stop		
	<i>Meaning set out in clause 3.9 of Land Transport (Road User) Rule 2004.</i>		
Shape and size	circle 750 mm diameter. Note: The sign may be perforated providing this does not affect the ability of the sign to perform safely and adequately for its intended use.		
Background	red (F)		
Border	None		
Legend	Description	Colour	Size
	'SCHOOL PATROL' curved to lie approximately parallel with the top edge of the sign, above	white (R)	100/9.5
	'STOP'	white (R)	285/35.5
R2-5	Hand-held stop		
	<i>Meaning set out in clause 3.8 of Land Transport (Road User) Rule 2004.</i>		
Shape and size	circle (top 60 mm removed) 450 mm diameter		
Background	red (R)		
Border	white (R) 15 mm		
Legend	Description	Colour	Size
	'STOP'	white (R)	200/19

R2-5.1	Hand-held go		
	<i>Meaning set out in clause 3.8 of Land Transport (Road User) Rule 2004.</i>		
Shape and size	circle (top 60 mm removed) 450 mm diameter		
Background	green (R)		
Border	white (R) 15 mm		
Legend	Description	Colour	Size
	'GO'	white (R)	200/31
R2-5.2	Hand-held slow		
	<i>Meaning set out in clause 3.8 of Land Transport (Road User) Rule 2004.</i>		
Shape and size	circle (top 60 mm removed) 450 mm diameter		
Background	green (R)		
Border	white (R) 15 mm		
Legend	Description	Colour	Size
	'SLOW'	white (R)	200/19
R2-6	Stop on red signal		
	<i>Used to reinforce requirement to stop at temporary or part-time signals.</i>		
Shape and size	rectangle 600 x 600 mm		
Background	white (R)		
Border	red (R) 15 mm		
Legend	Description	Colour	Size
	'STOP'	black	100/23
	'ON RED'	black	100/14
	'SIGNAL'	black	100/14

R2-6.1	Stop on red signal – variable		
	<i>Drivers must comply with red signal - used as an alternative message to R2-3.1.</i>		
Shape and size	rectangle 1200 x 1000 mm		
Background	black (unlit)		
Border	red, effective width 30 mm		
Legend	Description	Colour	Size
	‘STOP’	yellow (lit) or white (lit)	effective 200/31
	‘ON RED’	yellow (lit) or white (lit)	effective 200/31
	‘SIGNAL’	yellow (lit) or white (lit)	effective 200/31
R2-6.2	Stop here on red signal		
	<i>Drivers must stop for a red signal at the spot indicated by the sign.</i>		
Shape and size	rectangle 450 x 750 mm		
Background	white (R)		
Border	red (R) 15 mm		
Legend	Description	Colour	Size
	‘STOP’	black	120/17.2
	‘HERE’	black	120/17.2
	‘ON RED’	black	100/14
	‘SIGNAL’	black	100/14
R2-7	One way give way		
	<i>Meaning set out in subclause 4.1(3) of the Land Transport (Road User) Rule 2004.</i>		
Shape and size	circle 600 mm diameter		
Background	white (R)		
Border	red (R) 75 mm		
Legend	Description	Colour	Size
	‘upward arrow’ left of	red (R)	shaft 40 mm wide
	‘downward arrow’	black	shaft 60 mm wide
R2-7.1	Single lane supplementary Give way		
	<i>Supplementary to R2-7 reinforcing requirement to give way.</i>		
Shape and size	rectangle 600 x 250 mm		
Background	white (R)		

Border	red (R) 11 mm		
Legend	Description	Colour	Size
	‘GIVE WAY’	red (R)	100/12.5

R2-8	Single lane priority		
	<i>Traffic travelling in opposite direction should give way.</i>		
Shape and size	rectangle 450 x 500 mm		
Background	blue (R)		
Border	white (R) 15 mm		
Legend	Description	Colour	Size
	‘upward arrow’ left of	white (R)	shaft 60 mm wide
	‘downward arrow’	red (R) with white (R) border 3 mm	shaft 40 mm wide

R2-9	Turning traffic give way to pedestrians		
	<i>Reinforcing requirement to give way to pedestrians at traffic signals as set out in clause 3.2 of Land Transport (Road User) Rule 2004.</i>		
Shape and size	rectangle 375 x 475 mm		
Background	white (R)		
Border	red (R) 11 mm		
Legend	Description	Colour	Size
	‘TURNING’	black	50/7
	‘TRAFFIC’	black	50/7
	‘GIVE WAY’	black	50/7
	‘TO’	black	50/7
	‘PEDESTRIANS’	black	50/7

R2-9.1	Turning traffic give way to cyclists		
	<i>Reinforces requirement to give way to cyclists on a cycle path when turning at a give way sign, stop sign or traffic signals, in accordance with clause 3.2 or 4.1 of the Land Transport (Road User) Rule 2004. May supplement R2-1 or R2-2 signs or be installed on a pole supporting a traffic signal.</i>		
Shape and size	Rectangle 400 × 500mm		
Background	White (R)		
Border	Red (R) 15mm		
Legend	Description	Colour	Size
	‘TURNING’	black	50/7
	‘TRAFFIC’	black	50/7
	‘GIVE WAY’	black	50/7
	‘TO’	black	50/7
	‘CYCLISTS’	black	50/7

R2-9.2	Straight ahead traffic give way to cyclists		
	<i>Reinforces requirement to give way to cyclists on a cycle path when proceeding straight ahead from a give way or stop sign, in accordance with clause 4.1 of the Land Transport (Road User) Rule 2004. May supplement R2-1 or R2-2 signs.</i>		
Shape and size	Rectangle 400 × 600mm		
Background	White (R)		
Border	Red (R) 15mm		
Legend	Description	Colour	Size
	‘STRAIGHT’	black	50/7
	‘AHEAD’	black	50/7
	‘TRAFFIC’	black	50/7
	‘GIVE WAY’	black	50/7
	‘TO’	black	50/7
	‘CYCLISTS’	black	50/7
R2-10	Ramp signals – one vehicle per green each lane or line of traffic		
	<i>Only one vehicle per lane or line of traffic may proceed during each green phase of the associated traffic signal displays.</i>		
Shape and size	rectangle 1000 x 530 mm installed on traffic signal pole where ramp signals operate periodically (<i>subclause 6.4(20)</i>)		
Background	white (R)		
Border	red (R) 25 mm		
Legend	Description	Colour	Size
	‘ONE VEHICLE’	black	100/15.5
	‘PER GREEN’	black	100/15.5
	‘EACH LANE’	black	100/15.5
R2-11.1	Railway crossing flashing signal combination		
	<i>Meaning set out in subclause 9.2(3) of Land Transport (Road User) Rule 2004.</i>		
Shape and size	W15-3 above W15-4 (if used) above flashing signal head above R2-6		
R2-11.2	Railway crossing Stop sign combination		
	<i>Meaning set out in subclause 9.2(1) of Land Transport (Road User) Rule 2004.</i>		
Shape and size	W15-3 above W15-4 (if used) above R2-1 above W15-7 (if used)		

R2-11.3	Railway crossing Give-way sign combination		
	<i>Meaning set out in subclause 9.2(2) of Land Transport (Road User) Rule 2004.</i>		
Shape and size	W15-3 above W15-4 (if used) above R2-2		
R3	Direction and placement		
R3-1	No left turn		
	<i>No left turn.</i>		
Shape and size	circle 400 mm (urban), 600 mm (rural) diameter		
Background	white (R)		
Border	red (R) 50 mm (urban), 75 mm (rural)		
Legend	Description	Colour	Size
	‘diagonal bar’ superimposed on	red	bar 35 mm (urban), 50 mm (rural)
	‘left-turning arrow’	black	shaft 40 mm (urban), 60 mm (rural)
R3-2	No right turn		
	<i>No right turn.</i>		
Shape and size	circle 400 mm (urban), 600 mm (rural) diameter		
Background	white (R)		
Border	red (R), 50 mm (urban), 75 mm (rural)		
Legend	Description	Colour	Size
	‘diagonal bar’ superimposed on	red (R)	bar 35 mm (urban), 50 mm (rural)
	‘right-turning arrow’	black	shaft 40 mm (urban), 60 mm (rural)
R3-3	No U-turn		
	<i>No U-turn.</i>		
Shape and size	circle 400 mm (urban), 600 mm (rural) diameter		
Background	white (R)		
Border	red (R) 50 mm (urban), 75 mm (rural)		
Legend	Description	Colour	Size
	‘diagonal bar’ superimposed on	red (R)	bar 35 mm (urban), 50 mm (rural)
	‘upside down U arrow’	black	shaft 40 mm (urban), 60 mm (rural)

R3-4	No entry		
	<i>No entry.</i>		
Shape and size	circle 400 mm (urban), 600 mm (rural) diameter		
Background	red (R)		
Border			
Legend	Description	Colour	Size
	‘bar’	white (R)	320 x 80 mm (urban), 480 x 120 mm (rural)
	‘NO ENTRY’ central within bar	red (R)	50/6 (urban), 75/9.5 (rural)

R3-5.1 **Supplementary – except buses**

Supplementary sign for R3-1, R3-2, R3-3 or R3-4 signs excepting buses from ban on the relevant movement or R3-8, R3-9, R3-10 or R3-11 signs excepting buses from the requirement to make the relevant movement.

Shape and size rectangle 600 x 400 mm

Background white (R)

Border red (R) 20 mm

Legend	Description	Colour	Size
	‘EXCEPT’	black	100/15.5
	‘BUSES’	black	100/15.5

R3-5.2 Supplementary – except cycles			
<i>Supplementary sign for R3-1, R3-2, R3-3 or R3-4 signs excepting cycles from a ban on the relevant movement and for R3-8, R3-9, R3-10, R3-11 or R3-12 signs excepting cycles from the requirement to make the relevant movement.</i>			
Shape and size	Rectangle 400 × 250mm		
Background	White (R)		
Border	Red(R) 15mm		
Legend	Description	Colour	Size
	‘EXCEPT’	black	65/10.4
	‘CYCLES’	black	65/10.4

R3-5.3 Supplementary – except authorised vehicles			
<i>Supplementary sign for R3-1, R3-2, R3-3 or R3-4 signs excepting vehicles authorised by the road controlling authority from ban on the relevant movement or R3-8, R3-9, R3-10 or R3-11 signs excepting authorised vehicles from the requirement to make the relevant movement.</i>			
Shape and size	rectangle 600 x 600 mm		
Background	white (R)		
Border	red (R) 20 mm		
Legend	Description	Colour	Size
	‘EXCEPT’	black	100/15.5
	‘AUTHORISED’	black	100/15.5
	‘VEHICLES’	black	100/15.5

R3-5.4 Supplementary – except “class” or “description” of vehicle			
<i>Supplementary sign for R3-1, R3-2, R3-3 or R3-4 signs excepting the class or description of vehicle specified by the road controlling authority from the ban on the relevant movement or R3-8, R3-9, R3-10 or R3-11 signs excepting the class and description of vehicle from the requirement to make the relevant movement.</i>			
Shape and size	rectangle at least 600 x 400 mm and large enough to comfortably accommodate the legend		
Background	white (R)		
Border	red (R) 20 mm		
Legend	Description	Colour	Size
	‘EXCEPT’	black	100/15.5
	‘CLASS’ or ‘DESCRIPTION’ of vehicle	black	100/15.5

R3-6	Road closed		
	<i>Road closed – entry beyond the sign prohibited.</i>		
Shape and size	circle 400 mm (urban), 600 mm (rural) diameter		
Background	white (R)		
Border	red (R) 40 mm (urban), 60 mm (rural)		
Legend	Description	Colour	Size
	‘ROAD’	black	75/9.5 (urban),
	‘CLOSED’	black	100/12.5 (rural)
R3-7	Wrong way		
	<i>Drivers must not proceed beyond the sign.</i>		
Shape and size	rectangle 900 x 600 mm		
Background	red (R)		
Border	white (R) 25 mm		
Legend	Description	Colour	Size
	‘WRONG’	white (R)	150/23
	‘WAY’	white (R)	150/23
R3-7.1	Wrong way – go back		
	<i>Drivers must not proceed beyond this point and must reverse their direction out of the roadway.</i>		
Shape and size	rectangle 900 x 1200 mm		
Background	red (R)		
Border	white 25 mm		
Legend	Description	Colour	Size
	‘WRONG’	white (R)	150/23
	‘WAY’	white (R)	150/23
	‘stripe’	white (R)	750 x 25 mm
	‘GO’	white (R)	150/23
	‘BACK’	white (R)	150/23

R3-8	Turn left		
	<i>Turn left.</i>		
Shape and size	circle 400 mm (urban), 600 mm (rural) diameter		
Background	blue (R)		
Border	white (R) 15 mm (urban), 20 mm (rural)		
Legend	Description	Colour	Size
	‘left-turning arrow’	white (R)	shaft 50 mm (urban), 80 mm (rural)
R3-9	No turns		
	<i>Travel straight ahead – no turns.</i>		
Shape and size	circle 400 mm (urban), 600 mm (rural) diameter		
Background	blue (R)		
Border	white (R) 15 mm (urban), 20 mm (rural)		
Legend	Description	Colour	Size
	‘arrow pointing upward’	white (R)	shaft 50 mm (urban), 80 mm (rural)
R3-10	Turn right		
	<i>Turn right.</i>		
Shape and size	circle 400 mm (urban), 600 mm (rural) diameter		
Background	blue (R)		
Border	white (R) 15 mm (urban), 20 mm (rural)		
Legend	Description	Colour	Size
	‘right-turning arrow’	white (R)	shaft 50 mm (urban), 80 mm (rural)
R3-11	Turn		
	<i>Must turn either left or right.</i>		
Shape and size	circle 400 mm (urban), 600 mm (rural) diameter		
Background	blue (R)		
Border	white (R) 15 mm (urban), 20 mm (rural)		
Legend	Description	Colour	Size
	‘symbol with a left- and right-turning arrow head on common shaft’	white (R)	shaft 40 mm (urban), 60 mm (rural)

R3-12	One way			
	<i>Traffic may travel only in the direction shown by the arrow.</i>			
Shape and size	rectangle 600 x 250 mm			
Background	blue (R)			
Border	white (R) 10 mm			
Legend	Description	Colour	Size	
	‘horizontal arrow showing direction of travel’,	white (R)	shaft 75 mm	
	‘ONE WAY’ central within arrow	blue (R)	50/7	
R3-13	Keep left – single disc			
	<i>Keep left.</i>			
Shape and size	circle 400 mm (urban), 600 mm (rural) diameter			
Background	blue (R)			
Border	white (R) 15 mm (urban), 20 mm (rural)			
Legend	Description	Colour	Size	
	‘arrow pointing downward to the left at 45° to vertical’	white (R)	shaft 50 mm (urban), 80 mm (rural)	
R3-13.1	Keep left – twin disc			
	<i>Keep left.</i>			
Shape and size	two circles in a vertical pair, each 300 mm diameter			
Background	blue (R)			
Border	white (R) 10 mm			
Legend	Description	Colour	Size	
	‘arrow pointing downward to the left at 45° to vertical’	white (R)	shaft 40 mm	
R3-13.2	Keep right			
	<i>Keep right.</i>			
Shape and size	circle 400 mm (urban), 600 mm (rural) diameter			
Background	blue (R)			
Border	white (R) 15 mm (urban), 20 mm (rural)			
Legend	Description	Colour	Size	
	‘arrow pointing downward to the right at 45° to vertical’	white (R)	shaft 50 mm (urban), 80 mm (rural)	

R3-13.3 Truck mounted attenuator display

The display, installed on a vehicle equipped with an attenuator used to protect work being conducted on the road immediately beyond the sign, provides warning and indicates which side of the attenuator truck drivers should pass.

Shape and size rectangle 2200 x 3600 mm

Background symmetrical chevron with stripes sloping down at 45 degrees to each side, comprised of alternating red (R) and white (R) bands approximately 250 mm wide, measured perpendicular to the stripe. The chevron stripes may be applied only to the outer 500 mm at the top, bottom and sides of the sign and the central, rectangular panel, 1200 x 2600 mm, may be black, grey or white, or may be cut out.

Border none

Legend	Description	Colour	Size
	‘large lights’ (optional) at top left and right which flash simultaneously above one of Display A, B or C	yellow (when lit)	Diameter at least 300 mm
	Display A: ‘arrow pointing diagonally down to the left’ comprised of a pattern of lights above	Lights: yellow (when lit)	effective shaft width 180 mm
	R3-13 ‘keep left’	R3-13: blue (R) background, white (R) border and arrow	Diameter 1500 mm
	Display B: ‘arrow pointing diagonally down to the right’ comprised of a pattern of lights above	Lights: yellow (when lit)	effective shaft width 180 mm
	R3-13.2 ‘keep right’	R3-13.2: blue (R) background, white (R) border and arrow	diameter 1500 mm
	Display C: ‘a diagonal cross’ comprised of a pattern of lights above the shape of an R3-13 sign. Note: in this mode, the white arrow of the R3-13 must not be displayed.	Lights: yellow (when lit) R3-13 shape: blue (R) background and white (R) border	effective shaft width 180 mm diameter 1500 mm
Operation	Option 1 The two large lights at the top of the sign flash at a pulse rate of between 55 and 75 flashes per minute alternately with the illuminated portion of Display		

A, B or C, which also flashes at a pulse rate of between 55 and 75 flashes per minute.
Option 2
The large lights remain unlit (or are not fitted) while Display A, B or C are illuminated at a pulse rate of between 55 and 75 flashes per minute.

R3-14	Barrier arm		
	<i>When in place across a roadway, road traffic movement beyond the barrier arm is prohibited.</i>		
Shape and size	rectangle width varied to suit roadway being controlled x 50 mm height		
Front of barrier arm			
Background	any area of the barrier not forming part of the reflectorised area must be white		
Border	none		
Legend	Description	Colour	Size
	‘alternating vertical bands’	red (R) and white (R)	280 mm 180 mm
Reverse of barrier arm			
Background	any area of the barrier not forming part of the reflectorised area must be white		
Border	none		
Legend	Description	Colour	Size
	pattern of at least 3 rectangles equally spaced across the arm	red (R)	280 x 50 mm

R4	Lane use		
R4-1	Overhead lane use arrows – left/right turn		
	<i>Driver in lane must turn left or right (as appropriate) at next intersection.</i>		
Shape and size	rectangle 750 x 900 mm		
Background	white (R)		
Border	red (R) 25 mm		
Legend	Description	Colour	Size
	‘arrow pointing upward to the left or right (as appropriate)’	black	shaft 100 mm

R4-2	Overhead lane use arrows – straight ahead		
	<i>Driver in lane must travel straight ahead at next intersection.</i>		
Shape and size	rectangle 750 x 900 mm		
Background	white (R)		
Border	red (R) 25 mm		
Legend	Description	Colour	Size
	‘arrow pointing up’	black	shaft 100 mm
R4-3	Overhead lane use arrows – combination		
	<i>Driver in lane must turn left or right (as appropriate) or straight ahead at next intersection</i>		
Shape and size	rectangle 750 x 900 mm		
Background	white (R)		
Border	red (R) 25 mm		
Legend	Description	Colour	Size
	‘arrow pointing upward to the left or right (as appropriate) with arrow pointing up’	black	shaft 100 mm
R4-4	Lane control signs – downward-facing arrow		
	<i>Driver may proceed in lane.</i>		
Shape and size	rectangle 300 x 300 mm		
Background	black (unlit)		
Border	none		
Legend	Description	Colour	Size
	‘downward facing arrow’	green (lit)	shaft effective width 40 mm
R4-5	Lane control sign – diagonal arrow – change lanes now		
	<i>Driver must move to adjacent lane in direction indicated as soon as possible.</i>		
Shape and size	rectangle 300 x 300 mm		
Background	black (unlit)		
Border	none		
Legend	Description	Colour	Size
	‘left or right (as appropriate) diagonally downward arrow’	yellow (lit) or white (lit)	shaft effective width 40 mm

R4-6	Lane control sign – diagonal cross – lane closed		
	<i>Driver must not use lane.</i>		
Shape and size	rectangle 300 x 300 mm		
Background	black (unlit)		
Border	none		
Legend	Description	Colour	Size
	‘diagonal cross’	red (lit)	strokes effective width 40 mm
R4-7	Bus lane		
	<i>Adjacent lane is a bus lane available to buses, cycles, mopeds and motorcycles.</i>		
Shape and size	rectangle at least 600 x 600 mm		
Background	white (R)		
Border	red (R) 15 mm		
Legend	Description	Colour	Size
	‘symbol of bus (side-on)’ above	black	465 x 160 mm
	‘LANE’	black	120/17
R4-7.1	Bus only		
	<i>Adjacent lane is available only to buses.</i>		
Shape and size	rectangle at least 600 x 600 mm		
Background	white (R)		
Border	red (R) 15 mm		
Legend	Description	Colour	Size
	‘symbol of bus (side-on)’ above	black	465 x 160 mm
	‘ONLY’	black	120/17

R4-7.2	Bus Lane or Bus Only – single period		
	<i>Adjacent lane is a special vehicle lane available only to heavy motor vehicles.</i>		
Shape and size	rectangle 600 x height to fit text		
Background	white (R)		
Border	red (R) 15 mm		
Legend	Description	Colour	Size
	‘symbol of bus (side-on)’	black	465 x 160 mm
	‘LANE’ or ‘ONLY’	black	120/17
	‘[time period]’ for example:		
	7.30 – 9.30 AM	black	‘[hours]’ 80/13.6, ‘[minutes]’ 40/6.8, ‘AM’ or ‘PM’ 30/5.2
	MON - FRI	black	‘[days]’ 40/6.8

R4-7.3	Bus Lane or Bus Only – two periods		
	<i>Adjacent lane is a special vehicle lane available only to heavy motor vehicles.</i>		
Shape and size	rectangle 600 x height to fit text		
Background	white (R)		
Border	red (R) 15 mm		
Legend	Description	Colour	Size
	‘symbol of bus (side-on)’	black	465 x 160 mm
	‘LANE’ or ‘ONLY’	black	120/17
	‘[time periods]’ for example:		
	‘7.30 – 9.30 AM’	black	‘[hours]’ 80/13.6, ‘[minutes]’ 40/6.8, ‘AM’ or ‘PM’ 30/5.2
	‘4.00 – 6.00 PM’		
	MON - FRI		‘[days]’ 40/6.8

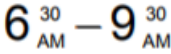
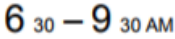
R4-8	Transit lane - single peak period		
	<i>Adjacent lane is available only to passenger service vehicles, vehicles carrying not less than the indicated number of occupants, cycles and motorcycles, during the periods indicated.</i>		
Shape and size	rectangle 600 x 700 mm		
Background	white (R)		
Border	red (R) 30 mm		
Legend	Description	Colour	Size
	‘TRANSIT’	black	80/13.6
	‘LANE’	black	80/13.6
	‘T2’ (or ‘T3’) within	white (R)	90/14
	‘barrel-like shape’	red (R)	195 x 130 mm
	to left of		
	‘symbol of car with 2 (or 3) occupants’	black	175 x 150 mm
	Time period, for example:	black	‘[minutes]’ 40/6.8
			‘[hours]’ 80/13.6
	or		‘AM’ (or ‘PM’) 30/5.2
			
	‘MON - FRI’	black	‘[days]’ 40/6.8

R4-8.1 Transit lane - two periods, same day

Adjacent lane is available only to passenger service vehicles, vehicles carrying not less than the indicated number of occupants, cycles and motorcycles, during the periods indicated.

Shape and size rectangle 600 x 775 mm

Background white (R)

Border red (R) 30 mm

Legend	Description	Colour	Size
	'TRANSIT'	black	80/13.6
	'LANE'	black	80/13.6
	'T2' (or 'T3') within 'barrel-like shape'	white (R)	90/14
	to left of 'symbol of car with 2 (or 3) occupants'	black	175 x 150 mm
	Time period, for example:		
	'6:30 – 10 AM'	black	'[minutes]' 40/6.8 '[hours]' 80/13.6
	'3:30 – 7PM'	black	'AM' (or 'PM') 30/5.2
	'MON – FRI'	black	'[days]' 40/6.8

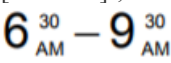
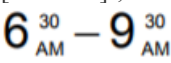
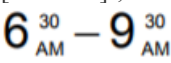
R4-8.2 Transit lane - two periods, different days – horizontal																
<i>Adjacent lane is available only to passenger service vehicles, vehicles carrying not less than the indicated number of occupants, cycles and motorcycles, during the periods indicated.</i>																
Shape and size	rectangle 750 x 600 mm															
Background	white (R)															
Border	red (R) 25 mm															
Legend	<table border="1"> <thead> <tr> <th>Description</th> <th>Colour</th> <th>Size</th> </tr> </thead> <tbody> <tr> <td>‘TRANSIT LANE’</td> <td>black</td> <td>75/12.7</td> </tr> <tr> <td>‘T2’ (or ‘T3’) within barrel-like shape to left of symbol of car with 2 (or 3) occupants</td> <td>white (R)</td> <td>90/14</td> </tr> <tr> <td>Time period: ‘[Period 1]’, for example </td> <td>black</td> <td>‘[minutes]’ 40/6.8, ‘[hours]’ 80/13.6, ‘AM’ (or ‘PM’) 30/5.2</td> </tr> <tr> <td>‘MON – FRI’ beside ‘[Period 2]’ in the same format as [Period 1] above</td> <td>black</td> <td>‘[days]’ 40/6.8</td> </tr> </tbody> </table>	Description	Colour	Size	‘TRANSIT LANE’	black	75/12.7	‘T2’ (or ‘T3’) within barrel-like shape to left of symbol of car with 2 (or 3) occupants	white (R)	90/14	Time period: ‘[Period 1]’, for example 	black	‘[minutes]’ 40/6.8, ‘[hours]’ 80/13.6, ‘AM’ (or ‘PM’) 30/5.2	‘MON – FRI’ beside ‘[Period 2]’ in the same format as [Period 1] above	black	‘[days]’ 40/6.8
Description	Colour	Size														
‘TRANSIT LANE’	black	75/12.7														
‘T2’ (or ‘T3’) within barrel-like shape to left of symbol of car with 2 (or 3) occupants	white (R)	90/14														
Time period: ‘[Period 1]’, for example 	black	‘[minutes]’ 40/6.8, ‘[hours]’ 80/13.6, ‘AM’ (or ‘PM’) 30/5.2														
‘MON – FRI’ beside ‘[Period 2]’ in the same format as [Period 1] above	black	‘[days]’ 40/6.8														

R4-8.3 Transit lane - two periods, different days – vertical																
<i>Adjacent lane is available only to passenger service vehicles, vehicles carrying not less than the indicated number of occupants, cycles and motorcycles, during the period indicated.</i>																
Shape and size	rectangle 600 x 850 mm															
Background	white (R)															
Border	red (R) 30 mm															
Legend	<table border="1"> <thead> <tr> <th>Description</th> <th>Colour</th> <th>Size</th> </tr> </thead> <tbody> <tr> <td>‘TRANSIT’</td> <td>black</td> <td>75/12.7</td> </tr> <tr> <td>‘LANE’</td> <td>black</td> <td>75/12.7</td> </tr> <tr> <td>‘T2’ (or ‘T3’) within ‘barrel-like shape’ to left of ‘symbol of car with 2 (or 3) occupants’</td> <td>white (R)</td> <td>90/14</td> </tr> <tr> <td>Time period: ‘[Period 1]’ above ‘[Period 2]’ where each period is described as in R4-8</td> <td>black</td> <td>‘[minutes]’ and ‘[hours]’ 50/8.5 ‘AM’ (or ‘PM’) 30/5.2 ‘[days]’ 50/8.5</td> </tr> </tbody> </table>	Description	Colour	Size	‘TRANSIT’	black	75/12.7	‘LANE’	black	75/12.7	‘T2’ (or ‘T3’) within ‘barrel-like shape’ to left of ‘symbol of car with 2 (or 3) occupants’	white (R)	90/14	Time period: ‘[Period 1]’ above ‘[Period 2]’ where each period is described as in R4-8	black	‘[minutes]’ and ‘[hours]’ 50/8.5 ‘AM’ (or ‘PM’) 30/5.2 ‘[days]’ 50/8.5
Description	Colour	Size														
‘TRANSIT’	black	75/12.7														
‘LANE’	black	75/12.7														
‘T2’ (or ‘T3’) within ‘barrel-like shape’ to left of ‘symbol of car with 2 (or 3) occupants’	white (R)	90/14														
Time period: ‘[Period 1]’ above ‘[Period 2]’ where each period is described as in R4-8	black	‘[minutes]’ and ‘[hours]’ 50/8.5 ‘AM’ (or ‘PM’) 30/5.2 ‘[days]’ 50/8.5														

R4-8.4	Transit lane - ends		
	<i>Transit lane ends.</i>		
Shape and size	rectangle 600 x 600 mm		
Background	white (R)		
Border	red (R) 30 mm		
Legend	Description	Colour	Size
	‘TRANSIT LANE’	black	75/12.7
	‘T2’ (or ‘T3’) within	white (R)	90/14
	‘barrel-like shape’	red (R)	345 x 230 mm
	‘ENDS’	black	100/17

R4-8.5	Transit and heavy vehicle lane		
	<i>Adjacent lane is a special vehicle lane available only to vehicles entitled to use a transit lane and to heavy motor vehicles.</i>		

Shape and size	rectangle 600 x 900 mm		
Background	white (R)		
Border	red (R) 15 mm		
Legend	Description	Colour	Size
	‘TRANSIT’	black	80/13.6
	‘T2 (or T3) within	white (R)	90/14
	barrel-like shape’ to the left of	red (R)	195 x 130 mm
	‘symbol of car with 2 (or 3) passengers’ above	black	175 x 150 mm
	‘symbol of truck (side on)’ above	black	320 x 160 mm
	‘LANE’	black	80/13.6

R4-9	Cycle lane		
	<i>Adjacent lane is available to cycles.</i>		
Shape and size	rectangle 600 x 600 mm		
Background	white (R)		
Border	red (R) 15 mm		
Legend	Description	Colour	Size
	‘symbol of cycle’ above	black	305 x 200 mm
	‘LANE’	black	120/17

R4-9.1	Cycle only		
	<i>Adjacent path is available only to cycles.</i>		
Shape and size	rectangle at least 600 x 600 mm		
Background	white (R)		
Border	red (R) 15 mm		
Legend	Description	Colour	Size
	‘symbol of cycle’ above	black	305 x 200 mm
	‘ONLY’	black	120/17

R4-10	Heavy vehicle lane		
	<i>Adjacent lane is a special vehicle lane available only to heavy motor vehicles.</i>		
Shape and size	rectangle 600 x 600 mm		
Background	white (R)		
Border	red (R) 15 mm		
Legend	Description	Colour	Size
	‘symbol of truck (side on)’	black	320 x 160 mm
	‘LANE’	black	120/17
R4-11	Shared path		
	<i>Adjacent path is available to pedestrians and cycles.</i>		
Shape and size	rectangle 400 x 600 mm		
Background	white (R)		
Border	red (R) 13 mm		
Legend	Description	Colour	Size
	‘symbol of pedestrian’ above	black	145 x 260 mm
	‘symbol of cycle’	black	230 x 150 mm
R4-11.1	Shared path – defined positions for users		
	<i>Adjacent shared path has defined positions for pedestrians and cycles.</i>		
Shape and size	rectangle 600 x 600 mm		
Background	white (R)		
Border	red (R) 20 mm		
Legend	Description	Colour	Size
	‘symbol of pedestrian’	black	145 x 260 mm
	above ‘ONLY’	black	80/11.2
	separated by line	black	10 mm wide
	from ‘symbol of cycle’	black	230 x 150 mm
	above ‘ONLY’	black	80/11.2
R4-12	Emergency stopping lane		
	<i>Adjacent lane is available only for the purposes of avoiding a collision or stopping in an emergency.</i>		
Shape and size	rectangle 1500 x 850 mm		
Background	white (R)		
Border	red (R) 20 mm		
Legend	Description	Colour	Size
	‘EMERGENCY’	black	160/24.5
	‘STOPPING’	black	160/24.5
	‘LANE ONLY’	black	160/24.5

R4-12.1 Emergency stopping lane – specified time			
<i>Adjacent lane is available only for the purposes of avoiding a collision or stopping in an emergency during the period specified.</i>			
Shape and size	rectangle 1500 x 1100 mm		
Background	white (R)		
Border	red (R) 20 mm		
Legend	Description	Colour	Size
	‘EMERGENCY’	black	160/24.5
	‘STOPPING’	black	160/24.5
	‘LANE ONLY’	black	160/24.5
	Time period, for example: 6³⁰ – 9³⁰ AM	black	‘hours’ 160/24.5, ‘minutes’ 80/12.2 ‘AM’ (or ‘PM’) 80/12.2
R4-12.2 Emergency stopping lane (combination)			
<i>Meaning set out in subclause 2.12(3) of the Land Transport (Road User) Rule 2004. Adjacent lane is available for the purposes of avoiding a collision or stopping in an emergency and for use by the class or classes of vehicles and for the times specified on another sign installed below this sign.</i>			
Shape and size	rectangle 900 x 600 mm		
Background	white (R)		
Border	red (R) 15 mm		
Legend	Description	Colour	Size
	‘EMERGENCY’	black	100/15.5
	‘STOPPING’	black	100/15.5
	‘LANE’	black	100/15.5

R4-13	Signal bypass lane – do not stop for signals – advance notice		
	<i>The special vehicle lane described by the sign is outside the area controlled by traffic signals ahead and vehicles entitled to use this lane do not need to comply with the signals displayed.</i>		
Shape and size	rectangle width 600 mm, height (at least 900 mm) to fit content		
Background	white (R)		
Border	red (R) 15 mm		
Legend	Description	Colour	Size
	'[text or symbols]' describing special vehicle lane (as detailed below) above	appropriate for type of special vehicle lane as detailed below	
	'LANE'	black	80/13.6
	'DO NOT'	black	80/13.6
	'STOP'	black	80/13.6
	'FOR'	black	80/13.6
	'SIGNALS'	black	80/13.6
Details – text or symbols			
One or more of the following symbols or text may be used on an R4-13 or R4-13.1 sign. If the lane is a transit lane the 'TRANSIT and transit symbols' should be located above any other class description.			
	Description	Colour	Size
	'TRANSIT and symbols'	black	80/13.6
	'TRANSIT'	black	80/13.6
	'T2 (or T3)' within 'barrel-like shape' to the left of	white (R)	90/14
	'symbol of car with 2 (or 3) passengers'	red (R)	195 x 130 mm
	'symbol of cycle'	black	175 x 150 mm
	'symbol of bus (side on)'	black	305 x 200 mm
	'symbol of truck (side on)'	black	465 x 160 mm
	'TAXI'	black	320 x 160 mm
	'[text]' to describe vehicle class	black	80/13.6

R4-13.1	Signal bypass lane – signals do not apply		
	<i>The special vehicle lane described by the sign is outside the area controlled by traffic signals and vehicles entitled to use this lane do not need to comply with the signals displayed.</i>		
Shape and size	rectangle width 600 mm, height (at least 900 mm) to fit content		
Background	white (R)		
Border	red (R) 15 mm		
Legend	Description	Colour	Size
	'[text or symbols]' describing special vehicle lane (as detailed below sign R4-13) above	appropriate for type of special vehicle lane (as detailed below sign R4-13)	
	'LANE'	black	80/13.6
	'SIGNALS'	black	80/13.6
	'DO NOT'	black	80/13.6
	'APPLY'	black	80/13.6
	'downward facing arrow'	black	shaft 40 mm

R4-13.2 Signal bypass lane – do not stop for signals supplementary

The special vehicle lane described by the sign above this supplementary sign is outside the area controlled by traffic signals and vehicles entitled to use the lane do not need to comply with the signals displayed.

Note: this sign must only be used as a supplementary sign in combination with an appropriate R4-7 to R4-12 or R4-14 series sign.

Shape and size rectangle 600 x 600 mm

Background white (R)

Border 15 mm red (R)

Legend	Description	Colour	Size
	'DO NOT'	black	80/14.4
	'STOP'	black	80/14.4
	'FOR'	black	80/14.4
	'SIGNALS'	black	80/14.4

R4-13.3 Special vehicle signal bypass lane – signals do not apply

The special vehicle lane below the sign is outside the area controlled by traffic signals and vehicles entitled to use the lane do not need to comply with the signals displayed.

Option A

Shape and size rectangle 2400 x 1200 mm

Background white (R)

Border 40 mm red (R)

Legend	Description	Colour	Size
	'SIGNALS'	black	200/36
	'DO NOT APPLY'	black	200/36
	'Downward pointing arrow' (type E)	Black	Shaft 80 mm

Option B

Shape and size rectangle 1500 x 1500 mm

Background white (R)

Border 40 mm red (R)

Legend	Description	Colour	Size
	'SIGNALS'	black	200/36
	'DO NOT'	black	200/36
	'APPLY'	black	200/36
	'Downward pointing arrow' (type E)	Black	Shaft 80 mm

R4-14 Special vehicle lane – two or more classes of vehicle

The adjacent lane, or lane below, if the sign is installed overhead, is a special vehicle lane reserved for the classes of vehicle shown on the sign.

Note: when the bus symbol is shown on the sign, cycles, mopeds and motorcycles may also use the lane, unless any of those classes is specifically excluded on a supplementary sign.

When "TRANSIT" and the transit symbols are included on the sign, passenger service vehicles, cycles, mopeds, motorcycles and vehicles carrying at least the number of people indicated on

the sign may also use the lane, unless any of those classes is specifically excluded on a supplementary sign.

Option A

Shape and size	rectangle 600 mm wide x height to suit the classes of vehicle		
Background	white (R)		
Border	15 mm red (R)		
Legend	Description	Colour	Size
	'[TEXT or symbols]' describing the classes of vehicle (as detailed below) above	(as detailed below)	(as detailed below)
	'LANE'	black	120/19.2

Details – text or symbols for R4-14 signs

The following symbols or text may be shown on R4-14 signs. If the lane is a transit lane, "TRANSIT" and the transit symbols should be shown above any other vehicle class.

Description	Colour	Size
"TRANSIT" above	Black	80/14.4
"T2 (or T3)" within	White (R)	90/14.4
"barrel-like shape" to the left of	Red (R)	195 x 130mm
"symbol of car with 2 (or 3) occupants"	Black	175 x 150mm
"symbol of a bus (side on)"	Black	465 x 160mm
"symbol of a cycle"	Black	245 x 160mm
"E V" (abbreviation for electric vehicle)	Black	120/21.6
"symbol of a motorcycle"	Black	305 x 160mm
"symbol of a truck (side on)" may include "3.5 t" within the truck symbol	Black White (R)	320 x 160mm 60/9.6
"TAXI"	Black	100/16
"[TEXT]" to describe the class of vehicle	Black	100/16

R4-14.1 Special vehicle lane – two classes of vehicle only

The adjacent lane, or lane below, if the sign is installed overhead, is a special vehicle lane reserved for two classes of vehicle only, as shown on the sign.

Shape and size Rectangle 600mm wide x height to suit the classes of vehicle

Background White (R)

Border	15mm red (R)		
Legend	Description	Colour	Size
	“[TEXT or symbols]” describing the classes of vehicle (as detailed below) above	(as detailed below)	(as detailed below)
	“ONLY”	Black	120/19.2

Details – text or symbols for R4-14.1 signs

Any two of the following symbols or text may be shown on R4-14.1 signs.

Description	Colour	Size
“symbol of a bus (side on)”	Black	465 x 160mm
“symbol of a cycle”	Black	265 x 160mm
“E V” (abbreviation for electric vehicle)	Black	120/21.6
“symbol of a motorcycle”	Black	305 x 160mm
“symbol of a truck (side on)” may include “3.5 t” within the truck symbol	Black White (R)	320 x 160mm 60/9.6
“TAXI”	Black	100/16
“[TEXT]” to describe the class of vehicle	Black	100/16

R5 Road user restrictions

R5-1	No cycling		
	<i>No cycling beyond the sign.</i>		
Shape and size	circle 400 mm (urban), 600 mm (rural) diameter		
Background	white (R)		
Border	red (R) 40 mm (urban), 60 mm (rural)		
Legend	Description	Colour	Size
	‘diagonal bar’ superimposed on	red (R)	bar 30 mm (urban), 45 mm (rural)
	‘symbol of cycle’	black	280 x 180 mm (urban), 420 x 270 mm (rural)
R5-2	No pedestrians		
	<i>No pedestrians beyond the sign.</i>		
Shape and size	circle 400 mm (urban), 600 mm (rural) diameter		
Background	white (R)		
Border	red (R) 40 mm (urban), 60 mm (rural)		
Legend	Description	Colour	Size
	‘diagonal bar’ superimposed on	red (R)	bar 30 mm (urban), 45 mm (rural)
	‘symbol of pedestrian’	black	160 x 280 mm (urban), 240 x 420 mm (rural)
R5-3	No heavy motor vehicles		
	<i>No heavy motor vehicles beyond the sign.</i>		
Shape and size	circle 400 mm (urban), 600 mm (rural) diameter		
Background	white (R)		
Border	red (R) 40 mm (urban), 60 mm (rural)		
Legend	Description	Colour	Size
	‘diagonal bar’ superimposed on’	red (R)	bar 30 mm (urban), 45 mm (rural)
	‘symbol of truck’	black	265 x 130 mm (urban), 400 x 200 mm (rural)

R5-4	Height restriction		
	<i>Vehicles over height shown in metres not permitted.</i>		
Shape and size	circle 600 mm diameter		
Background	white (R)		
Border	red (R) 60 mm		
Legend	Description	Colour	Size
	‘[vertical clearance] m’ between	black	numeral 150/19 ‘m’ 75/15
	‘two arrow heads’	black	100 x 100 mm
R5-5	Pedestrians		
	<i>Pedestrians must use the route indicated to proceed beyond the sign.</i>		
Shape and size	circle 400 mm (urban), 600 mm (rural) diameter		
Background	blue (R)		
Border	white (R) 15 mm (urban), 20 mm (rural)		
Legend	Description	Colour	Size
	‘symbol of pedestrian’	white (R)	160 x 280 mm (urban), 240 x 420 mm (rural)
R5-6	All cycles must exit		
	<i>Cycles must use the route indicated to proceed beyond the sign.</i>		
Shape and size	rectangle at least 600 x 600 mm		
Background	white (R)		
Border	red (R) 15 mm		
Legend	Description	Colour	Size
	‘arrow pointing in direction to follow’ above	black	shaft 40 mm
	‘symbol of cycle’	black	305 x 200 mm

R5-7	Road classification – class C		
	<i>Weight of vehicle is limited to class C beyond the sign. Regulation 5(5), Heavy Motor Vehicle Regulations 1974.</i>		
Shape and size	circle 250 mm diameter		
Background	white (R)		
Border	red (R) 15 mm		
Legend	Description	Colour	Size
	‘CLASS’	black	50/5
	‘C’	black	100/14
R5-7.1	Road classification – class I		
	<i>To indicate class C classification of weight ends and standard weight limits apply.</i>		
Shape and size	circle 250 mm diameter		
Background	white (R)		
Border	red (R) 15 mm		
Legend	Description	Colour	Size
	‘CLASS’	black	50/5
	‘I’	black	100/14
R5-7.2	Road classification – temporary class I		
	<i>To indicate that a class C road is temporarily a class I road.</i>		
Shape and size	rectangle 275 x 512 mm		
Background	white (R)		
Border	none		
Legend	Description	Colour	Size
	‘R5-7.1’, above	white (R), red and black	circle 250 mm diameter
	‘UNTIL’	black	50/5
	‘[day] [month]’	black	50/5
	‘[year]’	black	50/5

R5-8	Heavy vehicles – maximum length		
	<i>Maximum length of vehicles permitted beyond sign.</i>		
Shape and size	rectangle 1200 x 975 mm		
Background	white (R)		
Border	red (R) 25 mm		
Legend	Description	Colour	Size
	‘HEAVY VEHICLES’	black	100/12.5
	‘MAX. LENGTH’	black	150/21
	‘INCLUDING TRAILER’	black	100/14
	‘[length] m’	black	numeral 150/21 ‘m’ 75/15
R5-9	Heavy vehicle – bridge limits		
	<i>Restrictions for heavy vehicles on a bridge – axle weight, or gross weight or speed. One “panel” used for each limit and a sign may be comprised of a selection of 1 or 2 or of all 3 panels. Panel 2, relating to gross weight has two options. Where Option (a) of Panel 2 is used the sign may show any of the figures “30”, “40”, “50”, “60”, “70”, “80”, or “90” followed by “% of Class I”, in which case the maximum weight on any 2 or more adjacent axles shall not exceed the stated percentage of the maximum sum of axle mass or the total vehicle mass described in Tables 1.2, 1.3, 1.4 or 1.5 of Part 1 Axle Mass Limits – General Access or Tables 2.1 or 2.2 of Part 2 Total Mass Limits – General Access in Schedule 3 of Land Transport Rule: Vehicle Dimensions and Mass 2016.</i>		
Shape and size	rectangle 900 x 600 mm (one panel) 900 x 750 mm (two panels) 900 x 900 mm (three panels)		
Background	white (R)		
Border	red (R) 25 mm		
Legend	Description	Colour	Size
	‘HEAVY VEHICLE’	black	100/13
	‘BRIDGE LIMITS’	black	100/13
	Panel 1: ‘AXLES [weight] kg’	black	Text 75/12 ‘kg’ Tpt Med ‘x’ height 50 mm
	Panel 2: Option (a) ‘GROSS [percent] OF CLASS 1’ or Option (b) ‘GROSS [weight] kg’	black	‘GROSS’ 70/11.2 others 70/9.1 Text 75/12 ‘kg’ Tpt Med ‘x’ height 50 mm
	Panel 3: ‘SPEED [speed] km/h’	black	Text 75/12 ‘km/h’ Tpt Med ‘x’ height 50 mm

R5-9.1 Heavy vehicle bridge limit, axle sets*Restrictions for heavy vehicles on a bridge – axle sets.***Shape and size** Rectangle 1200 x height to fit text**Background** White (R)**Border** Red (R) 25mm

Legend	Description	Colour	Size
	‘HEAVY VEHICLE’ above	black	Text 100/13
	‘BRIDGE AXLE SET LIMITS’ above	black	Text 100/13
	‘[axle set combination] [total weight allowed on the entire axle set] T’	black	Text 75/12 ‘T’ Tpt Med ‘x’ height 50 mm

R5-9.2 Heavy vehicle bridge limit, number of axles and gross weight*Restrictions for heavy vehicles on a bridge – number of axles and gross weight.***Shape and size** Rectangle 1200 × height to fit text**Background** White (R)**Border** Red (R) 30mm

Legend	Description	Colour	Size
	‘HEAVY VEHICLE’ above	black	Text 100/13
	‘BRIDGE GROSS LIMITS’ above	black	Text 100/13
	‘NO. OF AXLES – GROSS WEIGHT’ above two columns	black	Text 75/12
	‘[number of axles] – [gross weight in tonnes] T’	black	Text 75/12 ‘T’ Tpt Med ‘x’ height 50 mm

R5-9.3 Heavy vehicle bridge limit, axle sets, number of axles and gross weight and speed

Restrictions for heavy vehicles on a bridge – axle sets or number of axles and gross weight or speed. One “panel” used for each limit type and a sign may be comprised of a selection of appropriate panels.

Option A (vertical format)

Shape and size	Rectangle 1200 × height to fit text		
Background	White (R)		
Border	Red (R) 25mm		
Legend	Description	Colour	Size
	‘HEAVY VEHICLE’ above	black	Text 100/13
	‘BRIDGE LIMITS’ above	black	Text 100/13
	Panel 1:		
	‘AXLE SETS’ above	black	Text 75/12
	‘[axle set combination] [total weight allowed on the entire axle set] T’	black	Text 75/12 ‘T’ Tpt Med ‘x’ height 50 mm
	Panel 2:		
	‘GROSS’ above	Black	Text 75/12
	‘NO. OF AXLES – GROSS WEIGHT’ above two columns	Black	Text 75/12
	‘[number of axles] – [gross weight in tonnes] T’	Black	Text 75/12 ‘T’ Tpt Med ‘x’ height 50 mm
	Panel 3:		
	‘SPEED LIMIT 30 km/h	Black	Text 75/12 ‘km/h’ Tpt Med ‘x’ height 50 mm

Option B (horizontal format)

Shape and size	Rectangle 2100 × height to fit text		
Background	White (R)		
Border	Red (R) 25mm		
Legend	Description	Colour	Size
	‘HEAVY VEHICLE’ above	black	Text 100/13
	‘BRIDGE LIMITS’ above	black	Text 100/13
	Panel 1:		
	‘AXLE SETS’ above	black	Text 75/12
	‘[axle set combination] [gross weight in tonnes] T’	black	Text 75/12

			'T' Tpt Med 'x' height 50 mm
	Next to Panel 2:		
	'GROSS' above	Black	Text 75/12
	'NO. OF AXLES – GROSS WEIGHT' above two columns	Black	Text 75/12
	'[number of axles] – [gross weight in tonnes] T'	Black	Text 75/12 'T' Tpt Med 'x' height 50 mm
	Panel 3:		Text 75/12 'T'
	'SPEED LIMIT 30 km/h	Black	Text 75/12 'km/h' Tpt Med 'x' height 50 mm

R5-9.4 Heavy vehicle bridge speed limit restriction

Advises drivers of heavy vehicles of a bridge speed limit restriction at the specified speed limit.

Shape and size	Rectangle 900 × 750mm		
Background	White (R)		
Border	Red (R) 25mm		
Legend	Description	Colour	Size
	'HEAVY VEHICLE' above	black	100/13
	'BRIDGE' above	black	100/13
	'SPEED LIMIT' above	black	100/13
	'SPEED [speed] km/h''	black	Text 75/12 'km/h' Tpt Med 'x' height 50 mm

R5-10	Heavy vehicle – axle limits		
	<i>Maximum axle weight permitted beyond sign.</i>		
Shape and size	rectangle 1000 x 750 mm		
Background	white (R)		
Border	red (R) 25 mm		
Legend	Description	Colour	Size
	‘HEAVY VEHICLE’	black	100/12.5
	‘AXLE LIMIT’	black	100/14
	‘[weight] kg’	black	numerals 150/21 ‘kg’ 75/15
R5-11	No camping		
	<i>No camping at any time in the area designated by the sign.</i>		
Shape and size	rectangle 600 x 800 mm		
Background	white (R)		
Border	red (R) 30 mm		
Legend	Description	Colour	Size
	‘circle’ with	red (R)	diameter 400 mm border 40 mm
	‘diagonal bar’ superimposed on	red (R)	bar 30 mm wide
	‘symbol A20-S5’ (symbol of tent above a caravan) above	black	240 x 300 mm
	‘NO’	red (R)	50/7.7
	‘CAMPING’	red (R)	50/7.7
R5-12	No campervan waste		
	<i>The dumping of waste from campervans is not permitted at the effluent or other dump site beyond the sign.</i>		
Shape and size	circle 400 mm (urban) 600 mm (rural) diameter		
Background	white (R)		
Border	red (R)		
Legend	Description	Colour	Size
	‘diagonal bar’ superimposed on	red (R)	bar 30 mm (urban) 45 mm (rural)
	a ‘campervan waste’ (A20-S14) symbol	black	200 x 200 (urban) 300 x 300 (rural)

R5-13 **No cruising zone**

The roadway is within a no cruising zone. Cruising is defined in the Land Transport Act 1998.

Option A

Shape and size rectangle 600 x 600 mm

Background white (R)

Border red (R) 15 mm

Legend	Description	Colour	Size
	'NO'	black	100/14
	'CRUISING'	black	100/14
	'ZONE'	black	100/14

Option B

Shape and size rectangle 600 x height to fit text

Background white (R)

Border red (R) 15 mm

Legend	Description	Colour	Size
	'NO'	black	100/14
	'CRUISING'	black	100/14
	'[time period]' for example '10.30PM-6.30AM'	black	'[hours]' 80/13.6 '[minutes]' 40/6.8 'AM' or 'PM' 30/5.2
	'ZONE'	black	100/14

R5-13.1 No cruising zone begins

The roadway beyond the sign is a no cruising zone. Cruising is defined in the Land Transport Act 1998.

Option A

Shape and size rectangle 600 x 600 mm

Background white (R)

Border red (R) 15 mm

Legend	Description	Colour	Size
	'NO'	black	100/14
	'CRUISING'	black	100/14
	'ZONE'	black	100/14
	'BEGINS'	black	100/14

Option B

Shape and size rectangle 600 x height to fit text

Background white (R)

Border red (R) 15 mm

Legend	Description	Colour	Size
	'NO'	black	100/14
	'CRUISING'	black	100/14
	'[time period]' for example '10.30PM-6.30AM'	black	'[hours]' 80/13.6 '[minutes]' 40/6.8 'AM' or 'PM' 30/5.2
	'ZONE'	black	100/14
	'BEGINS'	black	100/14

R5-13.2 No cruising zone ends

The no cruising zone that exists before the sign now ends. Cruising is defined in the Land Transport Act 1998.

Option A

Shape and size rectangle 600 x 600 mm

Background white (R)

Border red (R) 15 mm

Legend	Description	Colour	Size
	'NO'	black	100/14
	'CRUISING'	black	100/14
	'ZONE'	black	100/14
	'ENDS'	black	100/14

Option B

Shape and size rectangle 600 x height to fit text

Background white (R)

Border red (R) 15 mm

Legend	Description	Colour	Size
	'NO'	black	100/14
	'CRUISING'	black	100/14
	'[time period]' for example '10.30PM-6.30AM'	black	'[hours]' 80/13.6 '[minutes]' 40/6.8 'AM' or 'PM' 30/5.2
	'ZONE'	black	100/14
	'ENDS'	black	100/14

Parking sign - components

Every parking sign is comprised of up to four components defining the restriction by:

- Component 1 type of restriction
- Component 2 class of vehicle affected or type of parking
- Component 3 period of application
- Component 4 area of road affected

Sign colours

- (a) Signs where a no stopping symbol (R6-1A) or no parking symbol (R6-1B) is used have a white (R) background with a red (R) border and:
 - (i) the legend may be red (R) or black; and
 - (ii) any symbol (R6-2S) used is red (R).
- (b) Signs where a ‘P’ (R6-1C) or ‘P\$’ (R6-1D) is used have a blue (may be reflectorised) background with any R6-2S symbol used, legend and border white (may be reflectorised).

Sign format

A parking sign may be in one of the following formats.

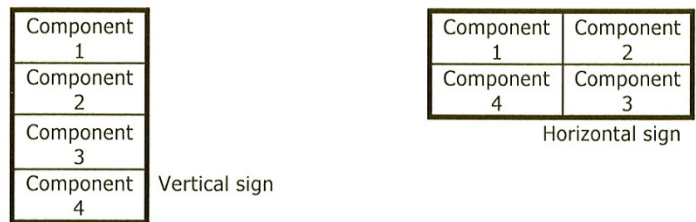

All parking signs must include one of the R6-1 symbols in Component 1 and may include, as appropriate, information detailed in R6-2, R6-3 or R6-4 in components 2, 3 or 4 respectively. Where one or more of components 2, 3 or 4 are not included, the vertical height of the sign may be reduced, however, the width must be retained.

For ‘Zone Begins’, ‘Zone Ends’ and some ‘Clearway’ signs the width of the vertical sign must be at least 600 mm. For all other parking signs the vertical signs must be at least 300 mm wide and the horizontal signs at least 600 mm wide.

Sign plate

A sign plate is a single, flat substrate upon which one or more signs may be affixed.

Sign panel

A sign panel may be comprised of 1, 2, 3 or 4 parking signs or may be comprised of a special vehicle lane sign that is required by clause 11.2(1)(b) or 11.2(2)(a) and no more than three parking signs in order to comply with 12.5(6). Each sign may be on a separate sign plate or combined on a sign plate with one or more of the other signs. One or more sign plates may comprise the panel. No more than one panel may be installed on the same pole or at the same location on the same building, wall or fence.

Typical layouts of signs within a panel

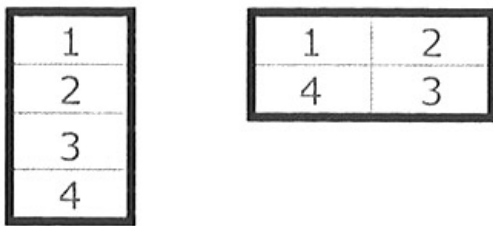

Panels with 1 sign

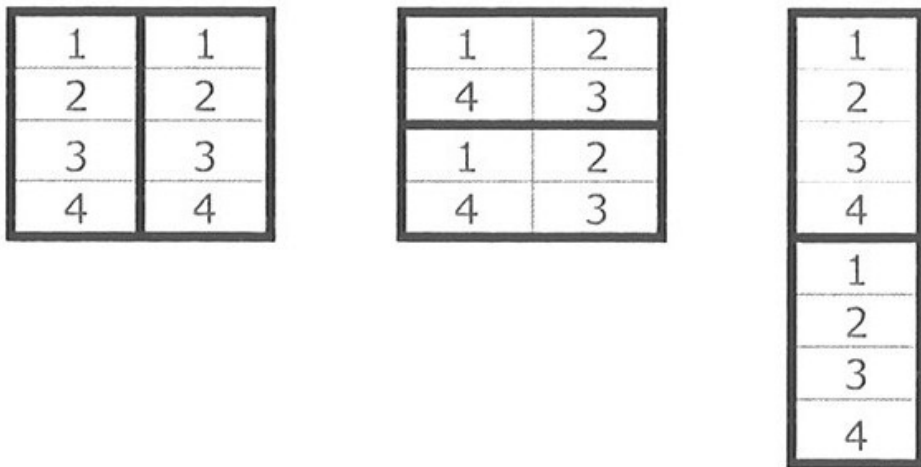

Panels with 2 signs

1	1
2	2
3	3
4	4
1	2
4	3

1	2
4	3
1	1
2	2
3	3
4	4

1	2
4	3
1	2
4	3
1	2
4	3

Panels with 3 signs

1	1
2	2
3	3
4	4
1	1
2	2
3	3
4	4

1	1
2	2
3	3
4	4
1	2
4	3
1	2
4	3

1	2
4	3
1	1
2	2
3	3
4	4
1	2
4	3

1	2
4	3
1	2
4	3
1	1
2	2
3	3
4	4

1	2
4	3
1	2
4	3
1	2
4	3
1	2
4	3

Panels with 4 signs

Order of signs within a panel

- (a) No sign incorporating a R6-1C must appear above a sign containing a R6-1D symbol.
- (b) No sign incorporating a R6-1C or a R6-1D must appear above a sign containing a R6-1B symbol.
- (c) No sign incorporating a R6-1B must appear above a sign containing a R6-1A symbol.
- (d) Any sign incorporating the words ‘Other Times’ must appear at the bottom of the panel.
- (e) A special vehicle lane sign installed on a panel must appear above all parking signs on that panel.

R6-1 Parking signs – Component 1 – Type of restriction

Signs explaining type of restriction in place in the area designated by the sign.

R6-1A No stopping

Drivers may not stop, stand or park in the area designated by the sign at all times (ie 24 hours, 7 days a week) unless a lesser time is indicated in Component 3.

Legend	Description	Colour	Dimensions
	circular border	red (R)	When used as a stand alone sign circle diameter 600 mm, border 75 mm wide, cross bars 60 mm wide.
	diagonal cross	red (R)	When used within a sign circle diameter 100 mm, border 12.5 mm wide, cross bars 10 mm wide.
	background	blue (R)	

R6-1B No parking

Drivers may not stop, stand or park at all times (ie 24 hours, 7 days a week) unless a lesser time is indicated in Component 3 except for drivers of the class or classes of vehicles indicated on the sign in Component 2 who may not stop stand or park other than for the purpose of loading passengers or goods and providing the driver remains in attendance of the vehicle.

Legend	Description	Colour	Dimensions
	circular border	red (R)	diameter 100 mm, border 12.5 mm wide
	diagonal bar	red (R)	bar 10 mm wide
	‘P’	black	60/9

R6-1C Parking permitted

Parking is permitted, generally for a specified maximum period, between 8:00 am and 6:00 pm every day except public holidays unless otherwise indicated in Component 3.

Legend	Description	Colour	Dimensions
	'P'	white on blue	100/17

R6-1C.1 Parking permitted, specified time Option 1

Parking permitted for the maximum period shown

Legend	Description	Colour	Dimensions
	'P'	white on blue	100/17
	'60' or such other period in a form described in R6-1T	white on blue	75/11.5

R6-1C.2 Parking permitted, specified time Option 2

Parking permitted for the maximum period shown

Legend	Description	Colour	Dimensions
	'P'	white on blue	100/17
	'60' or such other period in a form described in R6-1T	white on blue	75/11.5

R6-1D Parking permitted subject to fee

Parking permitted subject to the payment of a fee, generally for a specified maximum period, between the times of 8:00 am and 6:00 pm every day except public holidays unless otherwise indicated in Component 3. The maximum period or periods, the hours during which parking is permitted and the fees that apply must be displayed on each vending machine within the section of road or zone.

Legend	Description	Colour	Dimensions
	'P\$'	white on blue	'P' 100/17
			'\$' 75/11.5

R6-1D.1 Parking permitted subject to fee and maximum period of stay

Parking permitted subject to the payment of a fee and specified maximum period. The specified period must appear below the R6-1D 'P\$' symbol and not on the same row.

Legend	Description	Colour	Dimensions
	'P\$'	white on blue	'P' 100/17, '\$' 75/11.5
	'60' or such other period in a form described in R6-1T	white on blue	75/11.5

R6-1T Parking signs – Component 1 – time limits

Information detailing the parking time limits applying to the place designated by the sign.

R6-1T.1 Time in minutes up to one hour

Maximum time in minutes permitted, normally 2, 5, 10, 15 or 30 minutes but may be any number although commonly multiples of 10 or 15 minutes.

Example format	Colour	Dimensions
'2', '5', '10', '15', '30'	white on blue	75/11.5

R6-1T.2 Time in minutes up to 4 hours

Maximum time in minutes permitted, normally 60, 90, etc multiples of 30 minutes.

Example format	Colour	Dimensions
'60', '90', '120', '150', '180'	white on blue	75/11.5

R6-1T.3 Time in hours, 4 hours or more, up to 3 days

Maximum time in hours permitted, normally 4, 8, etc.

Example format	Colour	Dimensions
'6 hr'	white on blue	numerals 75/11.5 characters NZ Tpt Med 'x' height 50 mm

R6-1T.4 Time in days for 24 hours or more

Maximum time in days (24 hour periods).

Example format	Colour	Dimensions
'2 days'	white on blue	numerals 75/11.5 characters NZ Tpt Med 'x' height 50 mm

R6-2 Parking signs – Component 2 – Class of vehicle affected / type of parking

Information relating to the type of vehicle or type of parking affected by a parking sign.

R6-2A Text or symbols that may appear below or beside Symbol R6-1A

Clearway

Indicates the area is a no stopping area for specified periods for all vehicles. Vehicles stopping or parking are liable to be towed away.

Legend	Description	Colour	Dimensions
	'CLEARWAY'	red (R) or black	75/11.5 – when used to indicate where the clearway begins or ends and at the beginning of each block within the area 50/7 – if used within any block along the length of the clearway

R6-2B Text or symbols that may appear below or beside Symbol R6-1B

Bus stop

A stop for buses to allow the loading or unloading of passengers or at a terminus or stage point of a bus route and the driver must stay with the vehicle.

Legend	Description	Colour	Dimensions
	'[bus symbol]'	red (R) or black	symbol see R6-2S
	'Bus Stop'	red (R) or black	NZ Tpt Med 'x' height 35 mm

Carpool stop

A stop for approved carpool vehicles to pick up or drop off passengers.

Legend	Description	Colour	Dimensions
	'[car pool symbol]'	red (R) or black	symbol see R6-2S
	'Carpool Stop'	red (R) or black	NZ Tpt Med 'x' height 35 mm

Coach stop

A stop for coaches to allow the loading or unloading of passengers. Parking of the coach is not permitted and while the coach is stopped the driver must stay with the vehicle.

Legend	Description	Colour	Dimensions
	'[bus symbol]'	red (R) or black	symbol see R6-2S
	'Coach Stop'	red (R) or black	NZ Tpt Med 'x' height 35 mm

Pick-up and drop-off

The area is available only for picking up waiting passengers or dropping off passengers and the driver must stay with the vehicle.

Legend	Description	Colour	Dimensions
	'Pick Up'	red (R) or black	NZ Tpt Med 'x' height 35 mm
	'Drop Off'		

Small passenger service vehicle (PSV) stand

A stand for vehicles designed to carry less than 13 people used in a small passenger service providing the driver stays with the vehicle.

Option A

Legend	Description	Colour	Dimensions
	'Taxi Stand'	red (R) or black	NZ Tpt Med 'x' height 35 mm

Option B

Legend	Description	Colour	Dimensions
	'Small PSV'	red (R) or black	NZ Tpt Med 'x' height 35 mm
	'Stand'		

Tram stop

A stop for trams (light rail vehicles) to allow the loading or unloading of passengers or at a terminus or stage point of a tram route and the driver must stay with the vehicle.

Legend	Description	Colour	Dimensions
	'[tram symbol]'	red (R) or black	symbol see R6-2S
	'Tram Stop'	red (R) or black	NZ Tpt Med 'x' height 35 mm

Vehicle class or description not otherwise described

Only the specified class or description of vehicle described may stop, or stand providing the driver stays with the vehicle.

Legend	Description	Colour	Dimensions
	'[words describing the vehicle or class of vehicle]'	red (R) or black	NZ Tpt Med 'x' height 35 mm

R6-2C Text or symbols that may appear below or beside symbol R6-1C or R6-1D**Angle parking**

The area must be used with the parked vehicle at an angle to the direction of vehicle travel past the space. [See also 'forward in' and 'reverse in']

Legend	Description	Colour	Dimensions
	'Angle Parking'	white on blue	NZ Tpt Med 'x' height 35 mm

Authorized vehicles

Vehicles displaying a label or permit showing authorisation by a road controlling authority.

Legend	Description	Colour	Dimensions
	'Authorised'	white on blue	NZ Tpt Med 'x' height 35 mm
	'Vehicles'		

Bus parking

A place where buses may park.

Legend	Description	Colour	Dimensions
	'[bus symbol]'	white on blue	symbol see R6-2S

Carpool parking

Vehicles may only park when displaying an approved car pooling parking permit.

Legend	Description	Colour	Dimensions
	'[car pool symbol]'	white on blue	symbol see R6-2S
	'Carpool'	white on blue	NZ Tpt Med 'x' height 35 mm

Cycle parking

A cycle rack or other parking place reserved for cycles.

Legend	Description	Colour	Dimensions
	'[cycle symbol]'	white on blue	symbol see R6-2S

Diplomatic corps

Vehicles belonging to, or associated with, Embassies, Consuls, etc. entitled to, and displaying, CC, DC or FC vehicle number plates.

Legend	Description	Colour	Dimensions
	‘Diplomatic’ ‘Corps’	white on blue	NZ Tpt Med ‘x’ height 35 mm

Disabled parking

Vehicles may only park when displaying an approved disabled parking permit

Legend	Description	Colour	Dimensions
	‘[disabled symbol]’	white on blue	symbol see R6-2S

Electric vehicle charging

A parking place with a charging station, reserved for electric vehicles to charge their batteries.

Legend	Description	Colour	Dimensions
	‘[electric vehicle charging symbol]’	white on blue	symbol see R6-2S

Emergency vehicles

Vehicles clearly identifiable as being an emergency vehicle as defined in the Land Transport (Road User) Rule.

Legend	Description	Colour	Dimensions
	‘Emergency’ ‘Vehicles’	white on blue	NZ Tpt Med ‘x’ height 35 mm

Except

When used on a sign with a ‘P’ (R6-1C) or ‘P\$’ (R6-1D) symbol means the restriction and, if appropriate, the fee does not apply to the class or classes described following the word ‘Except’.

Must not be used on signs displaying either the no stopping (R6-1A) or no parking (R6-1B) symbol in relation to a class or classes of vehicles.

Legend	Description	Colour	Dimensions
	‘Except’ above	white on blue	NZ Tpt Med ‘x’ height 35 mm
	‘[words describing class]’ or	white on blue	NZ Tpt Med ‘x’ height 35 mm
	‘[symbol]’	white on blue	symbol see R6-2S

Forward parking

Relating to angle parking, means the driver must enter in a forward direction only.

Legend	Description	Colour	Dimensions
	'Forward In'	white on blue	NZ Tpt Med 'x' height 35 mm

Goods vehicles

Vehicles designed exclusively or principally for the carriage of goods or used for the collection or delivery of goods in the course of trade as defined in the Land Transport (Road User) Rule.

Legend	Description	Colour	Dimensions
	'Goods Vehicles'	white on blue	NZ Tpt Med 'x' height 35 mm

Goods service vehicles

Vehicles designed exclusively or principally for the carriage of goods and being used in a goods service defined in the Land Transport Act 1998.

Legend	Description	Colour	Dimensions
	'Goods Service' 'Vehicles'	white on blue	NZ Tpt Med 'x' height 35 mm

Loading zone

Vehicles may load and unload passengers and goods unless limited to either passengers or goods as described on the sign. The zone may be restricted to specific classes of vehicles and may be time limited.

Legend	Description	Colour	Dimensions
	'Loading Zone'	white on blue	NZ Tpt Med 'x' height 35 mm

Motorcycle parking

A parking place reserved for motorcycles or mopeds.

Legend	Description	Colour	Dimensions
	'[motor cycle symbol]'	white on blue	symbol see R6-2S

Motor home parking

A parking space reserved for motorhomes.

Legend	Description	Colour	Dimensions
	'[motorhome symbol]'	white on blue	symbol see R6-2S

Parking over roadway edge

A road controlling authority has, by appropriate legal means:

- (a) declared a former footpath or part of a footpath as roadway; or*
- (b) approved parking on the berm or other area to the left of the road edge line; and the driver may park their vehicle over the kerb or other edge line.*

Legend	Description	Colour	Dimensions
--------	-------------	--------	------------

‘[park over kerb symbol]’	white on blue	symbol see R6-2S
---------------------------	---------------	------------------

Pay parking conditions displayed on parking machine

The conditions of parking, including fees and times, are displayed on the parking machine.

Legend	Description	Colour	Dimensions
	“Conditions on Parking Machine”	white on blue	NZ Tpt Med ‘x’ height 35 mm

Police

Vehicles clearly identifiable as being owned and used by New Zealand Police.

Legend	Description	Colour	Dimensions
	‘Police’	white on blue	NZ Tpt Med ‘x’ height 35 mm

Residents permit parking

Parking permitted only for residents who hold and display a permit issued by the road controlling authority.

Legend	Description	Colour	Dimensions
	‘Residents’	white on blue	NZ Tpt Med ‘x’ height 35 mm
	‘Permit’		
	‘Parking’		

Reverse in parking

Relating to angle parking, means the driver must enter by reversing only.

Legend	Description	Colour	Dimensions
	‘Reverse In’	white on blue	NZ Tpt Med ‘x’ height 35 mm

Small PSV parking

A place where vehicles designed to carry less than 13 people used in a small passenger service may park.

Option A

Legend	Description	Colour	Dimensions
	‘Taxi’	white on blue	NZ Tpt Med ‘x’ height 35 mm

Option B

Legend	Description	Colour	Dimensions
	‘Small PSV’	white on blue	NZ Tpt Med ‘x’ height 35 mm

Vehicle class (not otherwise described)

A place where the specific class of vehicle described may park.

Legend	Description	Colour	Dimensions
	'[words describing class]'	white on blue	NZ Tpt Med 'x' height 35 mm

R6-2S Symbols used with appropriate R6 signs

Bus or coach

Description	Use	Colour	Dimensions
	R6-2B	red (R) on white (R)	symbol centered within a rectangle 200 x 100 mm
	R6-2C	white on blue	symbol 100 x 100 mm

Carpool

Description	Use	Colour	Dimensions
	R6-2B	red (R) on white (R)	symbol centered within a rectangle 200 x 100 mm
	R6-2C	white on blue	symbol 100 x 100 mm

Cycle

Description	Use	Colour	Dimensions
	R6-2C	white on blue	symbol centered within a rectangle 200 x 100 mm symbol 150 x 100 mm

Disabled

Description	Use	Colour	Dimensions
	R6-2C	white on blue	symbol centered within a rectangle 200 x 100 mm symbol 85 x 100 mm

Electric vehicle charging

Description	Use	Colour	Dimensions
	R6-2C	white on blue	symbol centred within a rectangle 200 x 100 mm symbol 100 x 100 mm

Heavy motor vehicle

Description	Use	Colour	Dimensions
	R6-2C	white on blue	symbol centered within a rectangle 200 x 100 mm symbol 200 x 100 mm

Mobility device

Description

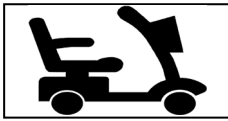

Use

R6-2C

Colour

white on blue

Dimensions

symbol centered within a rectangle 200 x 100 mm

symbol 120 x 100 mm

Motorcycle or moped

Description



Use

R6-2C

Colour

white on blue

Dimensions

symbol centered within a rectangle 200 x 100 mm

symbol 190 x 100 mm

Motorhome

Description

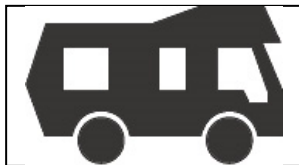

Use

R6-2C

Colour

white on blue

Dimensions

symbol centered within a rectangle 200 x 100 mm

symbol 160 x 100 mm

Park off roadway

Description



Use

R6-2C

Colour

white on blue

Dimensions

symbol centered within a rectangle 200 x 100 mm

symbol 100 x 100 mm

Park over kerb

Description



Use

R6-2C

Colour

white on blue

Dimensions

symbol centered within a rectangle 200 x 100 mm

symbol 100 x 100 mm

Tram (light rail vehicle)

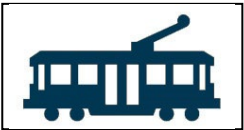
Description	Use	Colour	Dimensions
	R6-2B	red (R) on white (R)	symbol centered within a rectangle 200 x 100 mm
	R6-2C	white on blue	symbol 185 x 100 mm

R6-3 Parking signs – Component 3 – Period of application

Information detailing the time for which a parking restriction applies where this differs from the standard period of operation described for R6-1A, R6-1B, R6-1C or R6-1D.

Note: Character heights must be at least doubled on 'Zone Begins', 'Zone Ends' and 'Clearway Begins' and 'Clearway Ends' signs.

Abbreviations	Meaning of symbol or words	Minimum dimensions
min	minute, minutes	NZ Tpt Med 'x' height 25 mm
hr	hour, hours	NZ Tpt Med 'x' height 25 mm
am	morning	NZ Tpt Med 'x' height 25 mm
pm	afternoon	NZ Tpt Med 'x' height 25 mm
Noon	midday, 1200 hrs	NZ Tpt Med 'x' height 25 mm
Mon, Tue, Wed, Thu, Fri, Sat, Sun	days of the week	NZ Tpt Med 'x' height 25 mm
Jan, Feb, Mar, Apr, May, Jun, Jul, Aug, Sep, Oct, Nov, Dec	months of the year	NZ Tpt Med 'x' height 25 mm

Periods	Meaning of symbol or words	Minimum dimensions
8 am, 2 pm	Whole hours	NZ Tpt Med 'x' height 25 mm
6.15 am, 8.30 am, 7.45 pm	Parts of hours – generally (not exclusively) 15, 30 or 45 minutes past the hour	NZ Tpt Med 'x' height 25 mm
7 – 9 am, 4 – 6 pm	Period which begins and ends either in the morning or after midday	NZ Tpt Med 'x' height 25 mm
9 am – 4 pm	Period which begins in the morning and ends after midday	NZ Tpt Med 'x' height 25 mm
Mon - Fri	Days during which common restriction applies – first day to last day of a period in the same week	NZ Tpt Med 'x' height 25 mm

January, Jun – Sep, 10 Nov – 20 Feb	Time of year during which a common restriction applies	NZ Tpt Med ‘x’ height 25 mm
7 – 9 am 4 – 5.30 pm Mon - Fri	Two time periods within a single day or a common group of days	NZ Tpt Med ‘x’ height 25 mm
9 am – 4 pm Mon – Fri 9 am – Noon Saturday	Different times apply on two separate days or groups of days	NZ Tpt Med ‘x’ height 25 mm
6 pm Sat - 6 am Sun	Period starting one day finishing the following day	NZ Tpt Med ‘x’ height 25 mm
6 pm Fri - 6 am Mon	Continuous period starting one day and finishing 2 or more days later	NZ Tpt Med ‘x’ height 25 mm
6 pm – Midnight Thu – Sat Midnight – 6 am Fri - Sun	Period starting one day finishing the following day for several days during the week	NZ Tpt Med ‘x’ height 25 mm
Includes 6 – 9 pm Friday	Supplementary description extending on one day the period during which a common restriction applies.	NZ Tpt Med ‘x’ height 25 mm
Extended to 9 pm Fri	Supplementary description extending on one day the period during which a common restriction applies.	NZ Tpt Med ‘x’ height 25 mm
Except Sunday or Except Sun	Supplementary description indicating the restriction which, without the notice would apply every day, does not apply on a specific day of each week.	NZ Tpt Med ‘x’ height 25 mm
Except Sat - Sun	Supplementary description indicating the restriction which, without the notice would apply every day, does not apply on specific days of each week.	NZ Tpt Med ‘x’ height 25 mm
Every Day	Supplementary description indicating the restriction applies each day including public holidays.	NZ Tpt Med ‘x’ height 25 mm
At All Times	Supplementary description indicating the restriction applies 24 hours a day, every day. This may reinforce an existing 24 hour, 7 day restriction or extend the period of application of sign which normally applies for a lesser period (e.g. a P60).	NZ Tpt Med ‘x’ height 25 mm
Other Times	Supplementary description which: - if used on a sign which normally applies 24 hours a day every day (e.g. a bus stop), means all such other times not covered by any other signs for the same location which describe specific periods other restrictions apply. - if used on a sign which normally applies 8 am to 6pm every day except public holidays (e.g. a P60), means all such other times within those periods not covered by any other signs for the same location which describe specific periods other restrictions apply.	NZ Tpt Med ‘x’ height 25 mm

At All Other Times	Supplementary description if used on a sign which normally applies 8 am to 6pm every day except public holidays (e.g. a P60), means the restriction applies all such other times not covered by any other signs for the same location which describe specific periods other restrictions apply.	NZ Tpt Med 'x' height 25 mm
School Days	Supplementary description indicating the restriction applies only on days when pupils attend the school	NZ Tpt Med 'x' height 25 mm
Times Vary	The maximum parking period and times when parking is permitted or a fee must be paid may vary at different times of the day or days of the week. Used for pay parking where the conditions of parking are displayed on the parking machine.	NZ Tpt Med 'x' height 25 mm
10 min Maximum	loading or other activity limited by time: e.g. 10 minutes	NZ Tpt Med 'x' height 25 mm

R6-4 Parking signs – Component 4 – Extent of restriction
Information which describes the length of road or area affected by a parking sign.

Note: Character heights must be at least doubled on 'Zone Begins', 'Zone Ends' and 'Clearway Begins' and 'Clearway Ends' signs.

Arrow – left facing
Restriction on the sign applies for a length of road to the left of or before the sign.

Description	Use	Colour	Dimensions
	R6-1A or B	red (R) on white (R)	shaft width 15 mm
	R6-1C or D	white on blue	

Arrow – right facing
Restriction on the sign applies for a length of road to the right of or after the sign.

Description	Use	Colour	Dimensions
	R6-1A or B	red (R) on white (R)	shaft width 15 mm
	R6-1C or D	white on blue	

Arrow –facing left and right
Restriction on the sign applies for a length of road to the left and right or before and after the sign.

Description	Use	Colour	Dimensions
	R6-1A or B	red (R) on white (R)	shaft width 15 mm
	R6-1C or D	white on blue	

Next [distance] metres
Restriction on the sign applies for the specified length ([distance] in metres) of road beyond the sign.

Description	Use	Colour	Dimensions
-------------	-----	--------	------------

NEXT [distance] m	R6-1A or B	red (R) on white (R)	NZ Tpt Med 'x' height 50 mm
	R6-1C or D	white on blue	

For [distance] kilometres

Restriction on the sign applies for the specified length ([distance] in kilometres) of road beyond the sign.

Description	Use	Colour	Dimensions
FOR [distance] km	R6-1A or B	red (R) on white (R)	NZ Tpt Med 'x' height 50 mm
	R6-1C or D	white on blue	

Parking zone

The restriction on the sign applies to the surrounding area of roadway. The extent of the zone must be indicated by signs as described in clause 12.5(3).

Description	Use	Colour	Dimensions
ZONE or Zone	R6-1A or B	red (R) on white (R)	NZ Tpt Med 'x' height 50 mm
	R6-1C or D	white on blue	

Restriction begins

Restriction in Component 1 of the sign, which applies for a length of road or within a zone beyond the sign, begins. Any previous restriction, which applied for a length of road or within a zone before the sign, ends and is replaced by the new restriction.

Description	Use	Colour	Dimensions
BEGINS or Begins	R6-1A or B	red (R) on white (R)	NZ Tpt Med 'x' height 50 mm
	R6-1C or D	white on blue	

Restriction ends

Restriction in Component 1 of the sign, which applied for a length of road or within a zone before the sign, ends.

Description	Use	Colour	Dimensions
ENDS or Ends	R6-1A or B	red (R) on white (R)	NZ Tpt Med 'x' height 50 mm
	R6-1C or D	white on blue	

Description of area

A description of the area to which the parking restriction applies.

Description	Use	Colour	Dimensions
-------------	-----	--------	------------

‘[Words describing the area]’	R6-1A or B	red (R) or black on white (R)	NZ Tpt Med ‘x’ height 35 mm
	R6-1C or D	white on blue (may be reflectorised)	NZ Tpt Med ‘x’ height 35 mm

R6-5.1 Pay parking area identification supplementary

Supplementary parking sign to provide information such as a location code or area identification number for use in a technology based system for paying parking fees

Shape and size rectangle at least 300mm x 200mm. Sign dimensions may be increased to accommodate the legend or to match the parking sign it is supplementing.

Background blue (may be reflectorised)

Border white (may be reflectorised) 10mm

Legend	Description	Colour	Size
	such words or symbols as are necessary to convey the parking fees payment related information in no more than two lines	Words: white (may be reflectorised) symbols and background: as for the symbol and its background	Words: NZ Tpt Med ‘x’ height 25mm symbols and background: to fit within a rectangle of 180 x 180mm maximum
	code numerals or letters	White (may be reflectoriSed)	60/8.4

R7 General regulatory

R7-1 Keep left unless passing

Drivers must use left lane unless passing.

Shape and size rectangle 1350 x 750 mm

Background white (R)

Border red (R) 35 mm

Legend	Description	Colour	Size
---------------	--------------------	---------------	-------------

'KEEP LEFT'	black	120/24
'UNLESS'	black	120/24
'PASSING'	black	120/24

R7-1A	Keep left unless passing - urban		
	<i>Drivers must use left lane unless passing.</i>		
	<i>Note: This sign may be used only in urban areas as an alternative for a R7-1 sign.</i>		
Shape and size	rectangle 750 x 700 mm		
Background	white (R)		
Border	red (R) 18 mm		
Legend	Description	Colour	Size
	'KEEP'	black	100/14
	'LEFT'	black	100/14
	'UNLESS'	black	100/14
	'PASSING'	black	100/14
R7-1.1	Use left lane unless passing		
	<i>Drivers must use left lane unless passing.</i>		
Shape and size	rectangle 750 x 700 mm		
Background	black		
Border	red (R) 25 mm		
Legend	Description	Colour	Size
	'USE'	white (R)	100/14
	'LEFT LANE'	white (R)	100/14
	'UNLESS'	white (R)	100/14
	'PASSING'	white (R)	100/14
R7-2.1	Supplementary 'Begins'		
	<i>The restriction, requirement or other regulatory message contained on the sign above commences and applies beyond the sign.</i>		
Shape and size	rectangle 600 x 250 mm [may supplement any relevant regulatory sign]		
Background	white (R)		
Border	red (R) 10 mm		
Legend	Description	Colour	Size
	'BEGINS'	black	100/15.5

R7-2.2	Supplementary ‘Ends’		
	<i>The restriction, requirement or other regulatory message contained on the sign above ends.</i>		
Shape and size	rectangle 600 x 250 mm [may supplement any relevant regulatory sign]		
Background	white (R)		
Border	red (R) 10 mm		
Legend	Description	Colour	Size
	‘ENDS’	black	100/15.5
R7-2.3	Supplementary Next [distance]		
	<i>The restriction, requirement or other regulatory message contained on the sign above applies for the next [distance] metres.</i>		
Shape and size	rectangle 600 x 250 mm [may supplement any relevant regulatory sign]		
Background	white (R)		
Border	red (R) 10 mm		
Legend	Description	Colour	Size
	NEXT ‘[distance] m’ or NEXT ‘[distance]’ km’	black	100/15.5, ‘km’ or ‘m’ 50/10
R7-10	General regulatory		
	<i>Drivers must comply with the restriction, prohibition or direction described in the text on the sign.</i>		
Shape and size	rectangle at least 600 x 600 mm and sufficient to comfortably accommodate the legend		
Background	white (R)		
Border	red (R) 25 mm		
Legend	Description	Colour	Size
	‘[such words as are necessary to convey the restriction, prohibition or direction to traffic]’	black	100/14
R7-10.1	General regulatory – variable message		
	<i>Drivers must comply with the restriction, prohibition or direction described in the text on the sign.</i>		
Shape and size	rectangle sized to suit message requirements		
Background	black (unlit)		
Border	red (lit) effective width 25 mm, OR, where the variable message sign conveys only regulatory messages, may be red (R) 25 mm		
Legend	Description	Colour	Size

‘[such words as are necessary to convey the restriction, prohibition or direction to traffic in no more than 3 lines of text per screen and no more than 2 screens of text. If 2 screens are used the text must alternate between the 2 and not scroll between them.]’	yellow (lit) or white (lit)	effective 200/31
--	-----------------------------	------------------

Warning – Temporary

W1 Road works

W1-1	Road works symbol		
	<i>There are road works ahead.</i>		
Shape and size	diamond 750 mm square		
Background	orange (RF)		
Border	black 15 mm		
Legend	Description	Colour	Size
	‘symbol of person digging’	black	500 x 600 mm

W1-1B	Road works symbol (alternative form)		
	<i>There are road works ahead.</i>		
Shape and size	square 1200 x 1200 mm		
Background	white (R)		
Border	black 30 mm		
Legend	Description	Colour	Size
	W1-1 sign	orange (RF) and black	diamond 850 mm square

W1-1.1	Road works supplementary – “next [distance] km”		
	<i>There are road works for the next ‘[distance] km’ ahead. Two options.</i>		
	Option A		
Shape and size	rectangle 900 x 300 mm [supplements W1-1]		
Background	orange (RF)		
Border	black 25 mm		
Legend	Description	Colour	Size
	‘NEXT [distance] km’	black	‘NEXT’ 100/14, numeral 150/24, ‘km’ Tpt Med ‘x’ height 75 mm

Option B			
Shape and size	rectangle 1200 x 450 mm [supplements W1-1B]		
Background	orange (RF)		
Border	black 30 mm		
Legend	Description	Colour	Size
	‘NEXT [distance] km’	black	‘NEXT’ 125/17.5, numeral 175/28, ‘km’ Tpt Med ‘x’ height 90 mm

W1-1.2	Road works supplementary – new seal		
	<i>Newly laid road surface. Two options.</i>		
Option A			
Shape and size	rectangle 900 x 300 mm [supplements W1-1]		
Background	orange (RF)		
Border	black 25 mm		
Legend	Description	Colour	Size
	‘NEW SEAL’	black	120/19.2

Option B			
Shape and size	rectangle 1200 x 450 mm [supplements W1-1B]		
Background	orange (RF)		
Border	black 30 mm		
Legend	Description	Colour	Size
	‘NEW SEAL’	black	160/25.6

W1-1.3	Road works supplementary – mobile machinery (1-line)		
	<i>A mobile machine of the type named is operating beyond the sign. Two options.</i>		
Option A			
Shape and size	rectangle 900 x 300 mm [supplements W1-1]		
Background	orange (RF)		
Border	black 25 mm		
Legend	Description	Colour	Size
	for example: ‘GRADER’	black	120/19.2

Option B			
Shape and size	rectangle 1200 x 450 mm [supplements W1-1B]		

Background	orange (RF)		
Border	black 30 mm		
Legend	Description	Colour	Size
	for example:		
	‘GRADER’	black	160/25.6

W1-1.4	Road works supplementary – mobile machinery (2-line)		
	<i>A mobile machine of the type named is operating beyond the sign. Two options.</i>		
	Option A		
Shape and size	rectangle 900 x 450 mm [supplements W1-1]		
Background	orange (RF)		
Border	black 25 mm		
Legend	Description	Colour	Size
	for example:		
	‘WEED’	black	120/19.2
	‘SPRAYER’	black	120/19.2
	Option B		
Shape and size	rectangle 1200 x 600 mm [supplements W1-1B]		
Background	orange (RF)		
Border	black 30 mm		
Legend	Description	Colour	Size
	for example:		
	‘WEED’	black	160/25.6
	‘SPRAYER’	black	160/25.6
W1-1.5	Road works supplementary – road marking		
	<i>Road marker is operating beyond the sign. Two options.</i>		
	Option A		
Shape and size	rectangle 900 x 450 mm [supplements W1-1]		
Background	orange (RF)		
Border	black 25 mm		
Legend	Description	Colour	Size
	‘ROAD’	black	120/19.2
	‘MARKING’	black	120/19.2
	Option B		
Shape and size	rectangle 1200 x 600 mm [supplements W1-1B]		
Background	orange (RF)		
Border	black 30 mm		
Legend	Description	Colour	Size
	‘ROAD’	black	160/25.6
	‘MARKING’	black	160/25.6

W1-1.6		Road works supplementary – on side road		
<i>There are road works on the next side road. Two options.</i>				
Option A				
Shape and size	rectangle 900 x 450 mm [supplements W1-1]			
Background	orange (RF)			
Border	black 25 mm			
Legend	Description	Colour	Size	
	‘ON SIDE’	black	120/19.2	
	‘ROAD’	black	120/19.2	
Option B				
Shape and size	rectangle 1200 x 600 mm [supplements W1-1B]			
Background	orange (RF)			
Border	black 30 mm			
Legend	Description	Colour	Size	
	‘ON SIDE’	black	160/25.6	
	‘ROAD’	black	160/25.6	
W1-1.7		Road works supplementary – shoulder closed		
<i>The road shoulder is not able to be used – road width could be restricted. Two options.</i>				
Option A				
Shape and size	rectangle 900 x 450 mm [supplements W1-1]			
Background	orange (RF)			
Border	black 25 mm			
Legend	Description	Colour	Size	
	‘SHOULDER’	black	120/16.8	
	‘CLOSED’	black	120/16.8	
Option B				
Shape and size	rectangle 1200 x 600 mm [supplements W1-1B]			
Background	orange (RF)			
Border	black 30 mm			
Legend	Description	Colour	Size	
	‘SHOULDER’	black	160/22.4	
	‘CLOSED’	black	160/22.4	

W1-1.8		Road works supplementary – surveying		
<i>Surveyors are operating beyond the sign. Two options.</i>				
Option A				
Shape and size	rectangle 900 x 300 mm [supplements W1-1]			
Background	orange (RF)			
Border	black 25 mm			
Legend	Description	Colour	Size	
	‘SURVEYING’	black	120/16.8	
Option B				
Shape and size	rectangle 1200 x 450 mm [supplements W1-1B]			
Background	orange (RF)			
Border	black 30 mm			
Legend	Description	Colour	Size	
	‘SURVEYING’	black	160/22.4	
W1-1.9		Road works supplementary – works end		
<i>The area of road work has ended. Two options.</i>				
Option A				
Shape and size	rectangle 900 x 300 mm [supplements W1-1]			
Background	orange (RF)			
Border	black 25 mm			
Legend	Description	Colour	Size	
	‘WORKS END’	black	120/16.8	
Option B				
Shape and size	rectangle 1200 x 450 mm [supplements W1-1B]			
Background	orange (RF)			
Border	black 30 mm			
Legend	Description	Colour	Size	
	‘WORKS END’	black	160/22.4	

W1-1.10	<i>(Revoked)</i>		
<hr/>			
W1-1.11	Road works supplementary – wet tar		
<i>The road surface ahead has liquid bitumen or is very soft or the surface has other material which may affect vehicle stability or may spray and adhere to other vehicles. Two options.</i>			
Option A			
Shape and size	rectangle 900 x 300 mm [supplements W1-1]		
Background	orange (RF)		
Border	black 25 mm		
Legend	Description	Colour	Size
	‘WET TAR’	black	120/19.2
Option B			
Shape and size	rectangle 1200 x 450 mm [supplements W1-1B]		
Background	orange (RF)		
Border	black 30 mm		
Legend	Description	Colour	Size
	‘WET TAR’	black	160/25.6
<hr/>			
W1-1.12	Road works supplementary – skid testing		
<i>There will be slow moving vehicles ahead, testing the skid resistance of the road surface. Two options.</i>			
Option A			
Shape and size	rectangle 900 x 450 mm [supplements W1-1]		
Background	orange (RF)		
Border	black 25 mm		
Legend	Description	Colour	Size
	‘SKID’	black	120/19.2
	‘TESTING’	black	120/19.2
Option B			
Shape and size	rectangle 1200 x 600 mm [supplements W1-1B]		
Background	orange (RF)		
Border	black 30 mm		
Legend	Description	Colour	Size
	‘SKID’	black	160/25.6

	‘TESTING’	black	160/25.6
--	-----------	-------	----------

W1-1.13 Road works supplementary – bridge repairs

The bridge ahead is undergoing repairs. Two options.

Option A

Shape and size rectangle 900 x 450 mm [supplements W1-1]

Background orange (RF)

Border black 25 mm

Legend	Description	Colour	Size
	‘BRIDGE’	black	120/19.2
	‘REPAIRS’	black	120/19.2

Option B

Shape and size rectangle 1200 x 600 mm
[supplements W1-1B]

Background orange (RF)

Border black 30 mm

Legend	Description	Colour	Size
	‘BRIDGE’	black	160/25.6
	‘REPAIRS’	Black	160/25.6

W1-2 Road works 1 or 2 km

There are road works 1 or 2 km ahead.

Shape and size rectangle 1200 x 1800 mm

Background white (R)

Border black 30 mm

Legend	Description	Colour	Size
	W1-1 above	As for W1-1	As for W1-1
	‘1 km’ or ‘2 km’	black	Numeral 300/48, ‘km’ Tpt Med ‘x’ height 200 mm

W1-2B Road works 1 or 2 km (alternative form)

There are road works 1 or 2 km ahead

Shape and size rectangle 1200 x 600 mm

Background	white (R)		
Border	black 30 mm		
Legend	Description	Colour	Size
	'1 km' or '2 km'	black	numerals 300/48, 'km' Tpt Med 'x' height 200 mm

W1-3	Road works – 1 or 2 km delays possible		
	<i>There are road works 1 or 2 km ahead and delays are possible.</i>		
Shape and size	rectangle 2400 x 1800 mm		
Background	white (R)		
Border	black 40 mm		
Legend	Description	Colour	Size
	W1-1 above	as for W1-1	as for W1-1
	'1 km' or '2 km' to the left of words	black	numerals 300/48, 'km' Tpt Med 'x' height 200 mm
	'DELAYS'	black	200/28
	'POSSIBLE'	black	200/28

W1-4	Road works supplementary – temporary speed limit ahead		
	<i>There are road works with a temporary speed limit ahead</i>		
Shape and size	rectangle 1200 x 600 mm [supplements W1-1B]		
Background	white (R)		
Border	black 30 mm		
Legend	Description	Colour	Size
	'[speed]' to the left of	black	numerals 300/48
	'km/h'	black	Tpt Med 'x' height 85 mm
	'AHEAD'	black	120/19.2

W2 Hazard warning

W2-1 Hazard warning symbol			
<i>A hazard, described by a supplementary sign, exists beyond the sign. Two options.</i>			
Option A			
Shape and size	diamond 750 mm square		
Background	orange (RF)		
Border	black 15 mm		
Legend	Description	Colour	Size
	‘symbol of an exclamation mark’	black	225 x 740 mm
Option B			
Shape and size	square 1200 x 1200 mm		
Background	white (R)		
Border	black 30 mm		
Legend	Description	Colour	Size
	W2-1 sign, diamond 850 mm square	black and orange (RF)	as for W2-1

W2-1.1 Hazard warning supplementary – flooding			
<i>There is likely to be water across the road ahead. Two options.</i>			
Option A			
Shape and size	rectangle 900 x 300 mm [supplements W2-1]		
Background	orange (RF)		
Border	black 25 mm		
Legend	Description	Colour	Size
	‘FLOODING’	black	120/16.8
Option B			
Shape and size	rectangle 1200 x 450 mm [supplements W2-1B]		
Background	orange (RF)		
Border	black 30 mm		
Legend	Description	Colour	Size
	‘FLOODING’	black	160/22.4

W2-1.2	Hazard warning supplementary – washout		
	<i>Part of the road ahead has been washed out. Two options.</i>		
	Option A		
Shape and size	rectangle 900 x 300 mm [supplements W2-1]		
Background	orange (RF)		
Border	black 25 mm		
Legend	Description	Colour	Size
	‘WASHOUT’	black	120/19.2

	Option B		
Shape and size	rectangle 1200 x 450 mm [supplements W2-1B]		
Background	orange (RF)		
Border	black 30 mm		
Legend	Description	Colour	Size
	‘WASHOUT’	black	160/25.6

W2-1.3	Hazard warning supplementary – linecrew		
	<i>Linecrew are working ahead. Two options.</i>		
	Option A		
Shape and size	rectangle 900 x 300 mm [supplements W2-1]		
Background	orange (RF)		
Border	black 25 mm		
Legend	Description	Colour	Size
	‘LINECREW’	black	120/19.2
	Option B		
Shape and size	rectangle 1200 x 450 mm [supplements W2-1B]		
Background	orange (RF)		
Border	black 30 mm		
Legend	Description	Colour	Size
	‘LINECREW’	black	160/25.6

W2-1.4		Hazard warning supplementary – blasting	
<i>There is blasting ahead – expect explosions or being required to stop. Two options.</i>			
Option A			
Shape and size	rectangle 900 x 300 mm [supplements W2-1]		
Background	orange (RF)		
Border	black 25 mm		
Legend	Description	Colour	Size
	‘BLASTING’	black	120/19.2
Option B			
Shape and size	rectangle 1200 x 450 mm [supplements W2-1B]		
Background	orange (RF)		
Border	black 30 mm		
Legend	Description	Colour	Size
	‘BLASTING’	black	160/25.6
W2-1.5		Hazard warning supplementary – tree felling	
<i>Trees are being felled beside the road. Two options.</i>			
Option A			
Shape and size	rectangle 900 x 450 mm [supplements W2-1]		
Background	orange (RF)		
Border	black 25 mm		
Legend	Description	Colour	Size
	‘TREE’	black	120/19.2
	‘FELLING’	black	120/19.2
Option B			
Shape and size	rectangle 1200 x 600 mm [supplements W2-1B]		
Background	orange (RF)		
Border	black 30 mm		
Legend	Description	Colour	Size
	‘TREE’	black	160/25.6
	‘FELLING’	black	160/25.6

W2-1.6 Hazard warning supplementary – trucks crossing

Trucks are crossing where they do not normally or in greater numbers. Two options.

Option A

Shape and size rectangle 900 x 450 mm [supplements W2-1]

Background orange (RF)

Border black 25 mm

Legend	Description	Colour	Size
	'TRUCKS'	black	120/19.2
	'CROSSING'	black	120/19.2

Option B

Shape and size rectangle 1200 x 600 mm [supplements W2-1B]

Background orange (RF)

Border black 30 mm

Legend	Description	Colour	Size
	'TRUCKS'	black	160/25.6
	'CROSSING'	black	160/25.6

W2-1.7 Hazard warning supplementary – logging trucks

Logging trucks are crossing where they do not normally or there are more of them on the road than usual. Two options.

Option A

Shape and size rectangle 900 x 450 mm [supplements W2-1]

Background orange (RF)

Border black 25 mm

Legend	Description	Colour	Size
	'LOGGING'	black	120/19.2
	'TRUCKS'	black	120/19.2

Option B

Shape and size rectangle 1200 x 600 mm [supplements W2-1B]

Background orange (RF)

Border black 30 mm

Legend	Description	Colour	Size
	'LOGGING'	black	160/25.6
	'TRUCKS'	black	160/25.6

W2-1.8 Hazard warning supplementary – no road marking

Road marking has been removed, obscured or is yet to be installed where it would be expected to be marked. Two options.

Option A

Shape and size rectangle 900 x 450 mm [supplements W2-1]

Background orange (RF)

Border black 25 mm

Legend	Description	Colour	Size
	‘NO ROAD’	black	120/19.2
	‘MARKING’	black	120/19.2

Option B

Shape and size rectangle 1200 x 600 mm [supplements W2-1B]

Background orange (RF)

Border black 30 mm

Legend	Description	Colour	Size
	‘NO ROAD’	black	160/25.6
	‘MARKING’	black	160/25.6

W2-1.9 Hazard warning supplementary – signals changed

The traffic signals ahead have had the displays or sequence of displays changed. Two options.

Option A

Shape and size rectangle 900 x 450 mm [supplements W2-1]

Background orange (RF)

Border black 25 mm

Legend	Description	Colour	Size
	‘SIGNALS’	black	120/19.2
	‘CHANGED’	black	120/19.2

Option B

Shape and size rectangle 1200 x 600 mm [supplements W2-1B]

Background orange (RF)

Border black 30 mm

Legend	Description	Colour	Size
	‘SIGNALS’	black	160/25.6
	‘CHANGED’	black	160/25.6

W2-1.10	Hazard warning supplementary – signals not working		
	<i>The traffic signals ahead are not operating. Two options.</i>		
	Option A		
Shape and size	rectangle 900 x 450 mm [supplements W2-1]		
Background	orange (RF)		
Border	black 25 mm		
Legend	Description	Colour	Size
	‘SIGNALS NOT’	black	100/14
	‘WORKING’	black	120/16.8
	Option B		
Shape and size	rectangle 1200 x 600 mm [supplements W2-1B]		
Background	orange (RF)		
Border	black 30 mm		
Legend	Description	Colour	Size
	‘SIGNALS NOT’	black	150/21
	‘WORKING’	black	160/22.4
W2-1.11	Hazard warning supplementary – new road layout		
	<i>The road layout ahead has been changed recently. Two options.</i>		
	Option A		
Shape and size	rectangle 900 x 450 mm [supplements W2-1]		
Background	orange (RF)		
Border	black 25 mm		
Legend	Description	Colour	Size
	‘NEW ROAD’	black	120/16.8
	‘LAYOUT’	black	120/16.8
	Option B		
Shape and size	rectangle 1200 x 600 mm [supplements W2-1B]		
Background	orange (RF)		
Border	black 30 mm		
Legend	Description	Colour	Size
	‘NEW ROAD’	black	160/22.4
	‘LAYOUT’	black	160/22.4
W2-1.12	Hazard warning supplementary – traffic survey		

A traffic survey is being conducted ahead. Two options.

Option A**Shape and size** rectangle 900 x 450 mm [supplements W2-1]**Background** orange (RF)**Border** black 25 mm

Legend	Description	Colour	Size
	'TRAFFIC'	black	120/19.2
	'SURVEY'	black	120/19.2

Option B**Shape and size** rectangle 1200 x 600 mm [supplements W2-1B]**Background** orange (RF)**Border** black 30 mm

Legend	Description	Colour	Size
	'TRAFFIC'	black	160/25.6
	'SURVEY'	black	160/25.6

W2-1.13 Hazard warning supplementary – cycle race*There is a cycle race ahead – expect cyclists. Two options.***Option A****Shape and size** rectangle 900 x 300 mm [supplements W2-1]**Background** orange (RF)**Border** black 25 mm

Legend	Description	Colour	Size
	'CYCLE RACE'	black	120/16.8

Option B**Shape and size** rectangle 1200 x 450 mm [supplements W2-1B]**Background** orange (RF)**Border** black 30 mm

Legend	Description	Colour	Size
	'CYCLE RACE'	black	160/22.4

W2-1.14	Hazard warning supplementary – runners		
	<i>There is a running event ahead – expect runners. Two options.</i>		
	Option A		
Shape and size	rectangle 900 x 300 mm [supplements W2-1]		
Background	orange (RF)		
Border	black 25 mm		
Legend	Description	Colour	Size
	‘RUNNERS’	black	120/19.2
	Option B		
Shape and size	rectangle 1200 x 450 mm [supplements W2-1B]		
Background	orange (RF)		
Border	black 30 mm		
Legend	Description	Colour	Size
	‘RUNNERS’	black	160/25.6
W2-1.15	Hazard warning supplementary – walkers		
	<i>There is a walking event ahead – expect walkers. Two options.</i>		
	Option A		
Shape and size	rectangle 900 x 300 mm [supplements W2-1]		
Background	orange (RF)		
Border	black 25 mm		
Legend	Description	Colour	Size
	‘WALKERS’	black	120/19.2
	Option B		
Shape and size	rectangle 1200 x 450 mm [supplements W2-1B]		
Background	orange (RF)		
Border	black 30 mm		
Legend	Description	Colour	Size
	‘WALKERS’	black	160/25.6
W2-1.16	Hazard warning supplementary – cyclists ahead		
	<i>There is a cycling event ahead – expect cyclists. Two options.</i>		
	Option A		
Shape and size	rectangle 900 x 450 mm [supplements W2-1]		
Background	orange (RF)		

Border	black 25 mm		
Legend	Description	Colour	Size
	‘CYCLISTS’	black	120/19.2
	‘AHEAD’	black	120/19.2
Option B			
Shape and size	rectangle 1200 x 600 mm [supplements W2-1B]		
Background	orange (RF)		
Border	black 30 mm		
Legend	Description	Colour	Size
	‘CYCLISTS’	black	160/25.6
	‘AHEAD’	black	160/25.6

W2-1.17 Hazard warning supplementary – runners ahead

There is a running event ahead – expect runners. Two options.

Option A

Shape and size rectangle 900 x 450 mm [supplements W2-1]

Background orange (RF)

Border black 25 mm

Legend	Description	Colour	Size
	‘RUNNERS’	black	120/19.2
	‘AHEAD’	black	120/19.2

Option B

Shape and size rectangle 1200 x 600 mm [supplements W2-1B]

Background orange (RF)

Border black 30 mm

Legend	Description	Colour	Size
	‘RUNNERS’	black	160/25.6
	‘AHEAD’	black	160/25.6

W2-1.18 Hazard warning supplementary – walkers ahead

There is a walking event ahead – expect walkers. Two options.

Option A

Shape and size rectangle 900 x 450 mm [supplements W2-1]

Background orange (RF)

Border	black 25 mm		
Legend	Description	Colour	Size
	‘WALKERS’	black	120/19.2
	‘AHEAD’	black	120/19.2
Option B			
Shape and size	rectangle 1200 x 600 mm [supplements W2-1B]		
Background	orange (RF)		
Border	black 30 mm		
Legend	Description	Colour	Size
	‘WALKERS’	black	160/25.6
	‘AHEAD’	black	160/25.6

W2-1.19		Hazard warning supplementary – accident	
<i>There has been an accident ahead. Two options.</i>			
Option A			
Shape and size	rectangle 900 x 300 mm [supplements W2-1]		
Background	orange (RF)		
Border	black 25 mm		
Legend	Description	Colour	Size
	‘ACCIDENT’	black	120/19.2
Option B			
Shape and size	rectangle 1200 x 450 mm [supplements W2-1B]		
Background	orange (RF)		
Border	black 30 mm		
Legend	Description	Colour	Size
	‘ACCIDENT’	black	160/25.6
W2-1.20		Hazard warning supplementary – fire	
<i>There is a fire ahead. Two options.</i>			
Option A			
Shape and size	rectangle 900 x 300 mm [supplements W2-1]		
Background	orange (RF)		
Border	black 25 mm		
Legend	Description	Colour	Size
	‘FIRE’	black	120/21.6
Option B			
Shape and size	rectangle 1200 x 450 mm [supplements W2-1B]		
Background	orange (RF)		
Border	black 30 mm		
Legend	Description	Colour	Size
	‘FIRE’	black	160/28.8

W2-1.21 Hazard warning supplementary – funeral

There is a funeral ahead – there could be a large number of slow-moving or parked cars and pedestrians. Two options.

Option A

Shape and size rectangle 900 x 300 mm [supplements W2-1]

Background orange (RF)

Border black 25 mm

Legend	Description	Colour	Size
	‘FUNERAL’	black	120/19.2

Option B

Shape and size rectangle 1200 x 450 mm [supplements W2-1B]

Background orange (RF)

Border black 30 mm

Legend	Description	Colour	Size
	‘FUNERAL’	black	160/25.6

W2-1.22 Hazard warning supplementary – film crew

There is a crew filming ahead – expect people and equipment. Two options.

Option A

Shape and size rectangle 900 x 300 mm [supplements W2-1]

Background orange (RF)

Border black 25 mm

Legend	Description	Colour	Size
	‘FILM CREW’	black	120/19.2

Option B

Shape and size rectangle 1200 x 450 mm [supplements W2-1B]

Background orange (RF)

Border black 30 mm

Legend	Description	Colour	Size
	‘FILM CREW’	black	160/25.6

W2-1.23	Hazard warning supplementary – hidden queue		
	<i>There is likely to be a queue ahead which may be obscured. Two options.</i>		
	Option A		
Shape and size	rectangle 900 x 450 mm [supplements W2-1]		
Background	orange (RF)		
Border	black 25 mm		
Legend	Description	Colour	Size
	‘HIDDEN’	black	120/19.2
	‘QUEUE’	black	120/19.2
	Option B		
Shape and size	rectangle 1200 x 600 mm [supplements W2-1B]		
Background	orange (RF)		
Border	black 300 mm		
Legend	Description	Colour	Size
	‘HIDDEN’	black	160/25.6
	‘QUEUE’	black	160/25.6
W2-1.24	Hazard warning supplementary – barrier arms not working		
	<i>The barrier arms are not operating. Two options.</i>		
	Option A		
Shape and size	rectangle 900 x 450 mm [supplements W2-1]		
Background	orange (RF)		
Border	black 25 mm		
Legend	Description	Colour	Size
	‘BARRIERS’	black	120/16.8
	‘NOT WORKING’	black	120/15.6
	Option B		
Shape and size	rectangle 1200 x 600 mm [supplements W2-1B]		
Background	orange (RF)		
Border	black 30 mm		
Legend	Description	Colour	Size
	‘BARRIERS’	black	160/22.4
	‘NOT WORKING’	black	160/20.8

W2-1.25 Hazard warning supplementary – pedestrians*There are likely to be pedestrians on the road ahead. Two options.***Option A****Shape and size** Rectangle 900 × 300mm, supplements W2-1**Background** orange (RF)**Border** black 25 mm

Legend	Description	Colour	Size
	‘PEDESTRIANS’	black	100/14

Option B**Shape and size** Rectangle 1200 × 450mm, supplements W2-1B**Background** orange (RF)**Border** black 30 mm

Legend	Description	Colour	Size
	‘PEDESTRIANS’	black	150/21

W2-1.26 Hazard warning supplementary – cyclists merging*There are likely to be cyclists merging with other traffic on the road ahead. Two options.***Option A****Shape and size** Rectangle 900 × 450mm, supplements W2-1**Background** orange (RF)**Border** black 25 mm

Legend	Description	Colour	Size
	‘CYCLISTS’	black	120/15.6
	‘MERGING’	black	120/15.6

Option B**Shape and size** Rectangle 1200 × 600mm, supplements W2-1B**Background** orange (RF)**Border** black 30 mm

Legend	Description	Colour	Size
	‘CYCLISTS’	black	160/20
	‘MERGING’	black	160/20

W3		Specific warning		
W3-1	Slips			
	<i>Slips or fallen debris on the road ahead.</i>			
Shape and size	diamond 750 mm square			
Background	orange (RF)			
Border	black 15 mm			
Legend	Description	Colour	Size	
	‘symbol of debris falling from bank’	black	700 x 550 mm	
W3-2	Slippery surface			
	<i>Danger of skidding ahead.</i>			
Shape and size	diamond 750 mm square			
Background	orange (RF)			
Border	black 15 mm			
Legend	Description	Colour	Size	
	‘symbol of car skidding’	black	600 x 550 mm	
W3-2.1	Slippery surface supplementary – ice/grit			
	<i>Danger of skidding ahead due to ice or grit.</i>			
Shape and size	rectangle 900 x 300 mm [supplements W3-2]			
Background	orange (RF)			
Border	black 15 mm			
Legend	Description	Colour	Size	
	‘ICE / GRIT’	black	125/18	
W3-2.2	Slippery surface supplementary – slow when wet			
	<i>Warns road users to slow down to avoid the danger of skidding due to the wet road surface.</i>			
Shape and size	rectangle 900 x 450 mm [supplements W3-2]			
Background	orange (RF)			
Border	black 25 mm			
Legend	Description	Colour	Size	
	‘SLOW’	black	120/21.6	
	‘WHEN WET’	Black	120/19.2	
W3-3	Gravel surface			

Loose stones or chips – metal surface or new seal ahead.

Shape and size	diamond 750 mm square		
Background	orange (RF)		
Border	black 15 mm		
Legend	Description	Colour	Size
	‘symbol of car throwing up stones at oncoming car with broken window’	black	620 x 320 mm

W3-3.1 Gravel surface supplementary – new seal

Loose stones or chips – new seal ahead.

Shape and size	rectangle 900 x 300 mm [supplements W3-3]		
Background	orange (RF)		
Border	black 15 mm		
Legend	Description	Colour	Size
	‘NEW SEAL’	black	125/18

W3-3.2 Gravel surface supplementary – seal repairs

Loose stones or chips – patches of new seal ahead.

Shape and size	rectangle 900 x 400 mm [supplements W3-3]		
Background	orange (RF)		
Border	black 15 mm		
Legend	Description	Colour	Size
	‘SEAL’	black	125/19.5
	‘REPAIRS’	black	125/19.5

W3-4.1 Stock – cattle

Cattle ahead.

Shape and size	diamond 750 mm square		
Background	orange (RF)		
Border	black 15 mm		
Legend	Description	Colour	Size
	‘symbol of a cow’	black	550 x 400 mm

W3-4.2	Stock – sheep		
	<i>Sheep ahead.</i>		
Shape and size	diamond 750 mm square		
Background	orange (RF)		
Border	black 15 mm		
Legend	Description	Colour	Size
	‘symbol of a sheep’	black	500 x 400 mm
W3-5	Traffic signals ahead		
	<i>Temporary traffic signals ahead.</i>		
Shape and size	diamond 750 mm square		
Background	orange (Rf)		
Border	black 25 mm		
Legend	Description	Colour	Size
	‘symbol of traffic signals’	black with red (R), yellow (R) and green (R) circular inserts	420 x 615 mm circles 95 mm diameter
W3-6	Manual traffic control		
	<i>Manual traffic control ahead.</i>		
Shape and size	diamond 750 mm square		
Background	orange (Rf)		
Border	black 25 mm		
Legend	Description	Colour	Size
	‘symbol of person holding flag’	black	600 x 600 mm
W3-6.1	Supplementary – please stop on request		
	<i>Stop when requested to do so, may supplement a W6-2 or W2-1.12, and, where appropriate, may replace a W6-2.</i>		
Shape and size	rectangle 900 x 400 mm		
Background	orange (Rf)		
Border	black 25 mm		
Legend	Description	Colour	Size
	‘PLEASE STOP’	black	100/14
	‘ON REQUEST’	black	100/14

W3-7	Site access distance ahead		
	<i>Access to the work site is the specified distance and road side indicated.</i>		
Shape and size	rectangle 1200 x 1200 mm		
Background	orange (Rf)		
Border	black 25 mm		
Legend	Description	Colour	Size
	‘SITE’	black	125/19.5
	‘ACCESS’	black	125/19.5
	‘[distance] m’ all beside	black	numerals 160/24.5, ‘m’ 140/35
	‘symbol indicating access location’	black	100 x 900 mm
W3-8	Site access		
	<i>Sign indicating site access location.</i>		
Shape and size	rectangle 1200 x 1200 mm		
Background	orange (Rf)		
Border	black 25 mm		
Legend	Description	Colour	Size
	‘SITE’	black	160/24.5
	‘ACCESS’	black	160/24.5
	‘arrow pointing to left or right’	black	shaft 100 mm
W3-9	Uneven surface		
	<i>The road ahead has an uneven surface.</i>		
Shape and size	diamond 600 mm square		
Background	orange (Rf)		
Border	black 25 mm		
Legend	Description	Colour	Size
	‘symbol with two humps’	black	560 x 160 mm

W4 Lane management

W4-1.1	Lane closed – two-lane, one-way road		
	<i>Left or right lane (as appropriate) of two lanes, stops ahead.</i>		
Shape and size	rectangle 750 x 750 mm		
Background	white (R)		
Border	black 25 mm		
Legend	Description	Colour	Size
	‘up arrow and a left- or right-turning arrow’ below	black	shafts 65 mm
	‘triangular shape indicating lane closure’	orange (Rf)	350 x 230 mm
W4-1.2	Lane closed – three-lane, one-way road		
	<i>Left or right lane (as appropriate) of three lanes, stops ahead.</i>		
Shape and size	rectangle 750 x 750 mm		
Background	white (R)		
Border	black 25 mm		
Legend	Description	Colour	Size
	‘2 up arrows and a left- or right-turning arrow’ below	black	shafts 65 mm
	‘triangular shape indicating lane closure’	orange (Rf)	230 x 230 mm
W4-1.3	Lane closed – four-lane, one-way road		
	<i>Left or right lane (as appropriate) of four lanes, stops ahead.</i>		
Shape and size	rectangle 1500 x 1200 mm		
Background	white (R)		
Border	black 25 mm		
Legend	Description	Colour	Size
	‘3 up arrows and a left- or right-turning arrow’ below	black	shafts 100 mm
	‘triangular shape indicating lane closure’	orange (Rf)	360 x 350 mm

W4-1.4	Lane closed – centre lane, three lane, one way road		
	<i>Centre lane of three lanes stops ahead, traffic in centre lane move to left or right lane (as appropriate)</i>		
Shape and size	rectangle 750 x 750 mm		
Background	white (R)		
Border	black 25 mm		
Legend	Description	Colour	Size
	‘3 up arrows with parallel shafts at the base, centre arrow turning left or right’ below	black	shafts 100 mm
	‘trapezoidal shape indicating lane closure’	orange (Rf)	230 x 300 mm
W4-2.1	Lane shift – two-lane, one-way road		
	<i>Both lanes of two are required to move to the left or right (as appropriate).</i>		
Shape and size	rectangle 750 x 750 mm		
Background	white (R)		
Border	black 25 mm		
Legend	Description	Colour	Size
	‘2 arrows with parallel shafts moving from left to right or right to left’ between	black	shafts 65 mm
	‘2 trapezoidal shapes indicating road shape’	orange (Rf)	230 x 575 mm
W4-2.2	Lane shift – three-lane, one-way road		
	<i>All lanes of three are required to move to the left or right (as appropriate).</i>		
Shape and size	rectangle 1500 x 1200 mm		
Background	white (R)		
Border	black 25 mm		
Legend	Description	Colour	Size
	‘3 arrows with parallel shafts moving from left to right or right to left’ between	black	shafts 100 mm
	‘2 trapezoidal shapes indicating road shape’	orange (Rf)	350 x 670 mm

W4-3	Merging traffic – main road		
	<i>A lane enters from the specified side beyond the sign and is required to merge.</i>		
Shape and size	rectangle 750 x 750 mm		
Background	white (R)		
Border	black 25 mm		
Legend	Description	Colour	Size
	‘2 parallel up arrows with third arrow at 45° joining between	black	shafts 100 mm
	‘2 triangular shapes indicating road shape’	orange (Rf)	380 x 420 mm
W4-4	Merging traffic – side road		
	<i>Beyond the sign driver must merge with main road.</i>		
Shape and size	rectangle 750 x 750 mm		
Background	white (R)		
Border	black 25 mm		
Legend	Description	Colour	Size
	‘2 parallel arrows at 45° with third up arrow joining between	black	shaft 100 mm
	‘a trapezoid and a triangle indicating road shape’	orange (Rf)	trapezoid 160 x 950 mm, triangle 420 x 420 mm
W4-5	Advance exit		
	<i>An exit leaves from the specified side beyond the sign.</i>		
Shape and size	rectangle 750 x 750 mm		
Background	white (R)		
Border	black 25 mm		
Legend	Description	Colour	Size
	‘2 parallel up arrows with third arrow at 45° upwards left or right (as appropriate)’ between	black	shafts 100 mm
	‘2 triangular shapes indicating road shape’	orange (Rf)	380 x 380 mm

W4-6	Exit direction		
	<i>Indicates location of exit.</i>		
Shape and size	rectangle 750 x 750 mm		
Background	orange (Rf)		
Border	black 25 mm		
Legend	Description	Colour	Size
	‘EXIT’	black	250/62
	‘arrow at 45° upwards left or right (as appropriate)’	black	shaft 110 mm
W4-7	One lane – one side narrowing		
	<i>Road reduces to one lane from either left or right (as indicated).</i>		
Shape and size	diamond 750 mm square [must be supplemented by W4-7.1]		
Background	orange (Rf)		
Border	black 15 mm		
Legend	Description	Colour	Size
	‘symbol of road narrowing left or right’	black	240 x 420 mm
W4-7.1	One lane – supplementary sign		
	<i>Supplements W4-7 or W4-8</i>		
Shape and size	rectangle 900 x 300 mm		
Background	orange (Rf)		
Border	black 15 mm		
Legend	Description	Colour	Size
	‘ONE LANE’	black	125/18
W4-8	One lane – both sides narrowing		
	<i>Road reduces to one lane, both sides narrow.</i>		
Shape and size	diamond 750 mm square [must be supplemented by W4-7.1]		
Background	orange (Rf)		
Border	black 15 mm		
Legend	Description	Colour	Size
	‘symbol of road narrowing both sides’	black	240 x 420 mm

W4-9	Arrow board – variable		
	<i>Drivers should move in the direction indicated to pass the vehicle displaying the sign. The sign is normally mounted on a vehicle used to protect work being conducted on the road immediately beyond the sign.</i>		
Shape and size	rectangle 1200 x 600 mm		
Background	black or black (unlit)		
Border	none		
Legend	Description	Colour	Size
	‘pattern of light sources forming the shape of an arrow pointing left or right’	yellow (lit)	effective line width of shaft and arrow head, 80 mm
	The pattern may be a cyclic display where the arrow shaft is extended as the arrowhead moves in stages in the direction drivers are required to move. The incremental changes and the timing of the cyclic display will vary depending on the technology used.		

W4-10	Distance ahead supplementary		
	<i>The warning applies the stated distance beyond the sign (may supplement W4 series signs).</i>		
Shape and size	rectangle 1200 x 400 mm		
Background	orange (Rf)		
Border	black 25 mm		
Legend	Description	Colour	Size
	‘[distance] m’	black	200/34, ‘m’ 140/35

W4-11	Diverge		
	<i>The road diverges on both sides of an obstruction ahead.</i>		
Shape and size	diamond 600 mm square		
Background	orange (Rf)		
Border	black 15 mm		
Legend	Description	Colour	Size
	‘downward diagonal arrows facing left and right’	black	shafts 80 mm

W5	Closure/detour		
W5-1	Road closed ahead		
	<i>Road closed ahead.</i>		
Shape and size	rectangle 1000 x 750 mm		

Background	orange (Rf)		
Border	black 25 mm		
Legend	Description	Colour	Size
	'ROAD'	black	125/21
	'CLOSED'	black	125/21
	'AHEAD'	black	125/21

W5-1.1 Exit closed ahead

The next exit from the road is closed and drivers will have to detour.

Shape and size	rectangle 1000 x 750 mm		
Background	orange (Rf)		
Border	black 25 mm		
Legend	Description	Colour	Size
	'EXIT'	black	125/21
	'CLOSED'	black	125/21
	'AHEAD'	black	125/21

W5-2 Detour ahead follow 'symbol'

Detour ahead – the alternative route is indicated by a symbol in form of W5-2.11, 2.12 or 2.13.

Shape and size	rectangle 1000 x 750 mm		
Background	orange (Rf)		
Border	black 25 mm		
Legend	Description	Colour	Size
	'DETOUR'	black	125/21
	'AHEAD'	black	125/21
	'FOLLOW' beside	black	100/15.5
	'detour symbol, W5-2.11, 2.12 or 2.13'	black and white (R)	as for W5-2.11, 2.12 or 2.13

W5-2.11 Detour symbol – square

Symbol used on W5-2 sign to describe a detour route.

Shape and size	square 150 x 150 mm		
Background	white (R)		
Border	black 10 mm		

W5-2.12	Detour symbol – circle		
	<i>Symbol used on W5-2 sign to describe a detour route.</i>		
Shape and size	circle 225 mm diameter		
Background	white (R)		
Border	black 10 mm		
W5-2.13	Detour symbol – diamond		
	<i>Symbol used on W5-2 sign to describe a detour route.</i>		
Shape and size	diamond 150 mm square		
Background	white (R)		
Border	black 10 mm		
W5-2.14	Detour symbol – State Highway		
	<i>Symbol used on W5-3 sign to describe a State Highway detour route.</i>		
Shape and size	State Highway shield 160 x 160 mm		
Background	red (R)		
Border	white (R) 10 mm		
W5-2.21	Detour direction indicators – 90° right (left) turn		
	<i>Indicates detour turns right or left as appropriate.</i>		
Shape and size	rectangle 900 x 400 mm		
Background	orange (Rf)		
Border	black 25 mm		
Legend	Description	Colour	Size
	‘symbol W5-2.11, 2.12 or 2.13’ beside	black and white (R)	as for W5-2.11, 2.12 or 2.13
	‘arrow pointing left or right’	black	shaft 30 mm
W5-2.22	Detour direction indicators – right (left) veer		
	<i>Indicates detour veers right or left as appropriate.</i>		
Shape and size	rectangle 900 x 400 mm		
Background	orange (Rf)		
Border	black 25 mm		
Legend	Description	Colour	Size

	‘symbol W5-2.11, 2.12 or 2.13’ beside	black and white (R)	as for W5-2.11, 2.12 or 2.13
	‘arrow diagonally left or right’	black	shaft 30 mm

W5-2.23 Detour direction indicators – straight ahead

Indicates detour goes straight ahead.

Shape and size rectangle 900 x 400 mm

Background orange (Rf)

Border black 25 mm

Legend	Description	Colour	Size
	‘symbol W5-2.11, 2.12 or 2.13’ beside	black and white (R)	as for W5-2.11, 2.12 or 2.13
	‘arrow pointing up’	black	shaft 30 mm

W5-3		Emergency State Highway detour route sign	
<i>Detour to the State Highway ahead – the alternative route is indicated by a W5-2.14 symbol.</i>			
Shape and size	rectangle 1000 x 1000 mm		
Background	orange (Rf)		
Border	black		
Legend	Description	Colour	Size
	‘STATE’	black	125/21
	‘HIGHWAY’	black	125/21
	‘DETOUR’	black	125/21
	‘FOLLOW’ beside	black	100/15.5
	‘symbol in the form of W5-2.14’	white (R) and red (R)	as for W5-2.14
W5-3.1		Emergency detour route direction indicator signs	
<i>Indicates detour goes straight ahead.</i>			
Shape and size	rectangle 900 x 400 mm		
Background	orange (Rf)		
Border	black 25 mm		
Legend	Description	Colour	Size
	‘symbol W5-2.14’ beside	white (R) and red (R)	as for W5-2.14
	‘arrow oriented up, diagonally or sideways’	black	shaft 30 mm
W5-4		Detour ends	
<i>Detour ends – normal route continues.</i>			
Shape and size	rectangle 900 x 400 mm		
Background	orange (Rf)		
Border	black 25 mm		
Legend	Description	Colour	Size
	‘DETOUR’	black	160/27.5
	‘ENDS’	black	160/27.5

W5-5	Crossing closed please use alternative crossing		
	<i>Pedestrian crossing point closed use alternative crossing.</i>		
Shape and size	rectangle 900 x 400 mm		
Background	orange (Rf)		
Border	black 25 mm		
Legend	Description	Colour	Size
	'CROSSING CLOSED'	black	75/10.5
	'PLEASE USE'	black	75/10.5
	'ALTERNATIVE CROSSING'	black	75/9.5
W5-6	Footpath closed please use other side		
	<i>Footpath closed use other side of roadway.</i>		
Shape and size	rectangle 900 x 400 mm		
Background	orange (Rf)		
Border	black 25 mm		
Legend	Description	Colour	Size
	'FOOTPATH CLOSED'	black	75/10.5
	'PLEASE USE'	black	75/11.5
	'OTHER SIDE'		
W5-7.11	Pedestrian direction indicators – 90° left (right) turn		
	<i>Pedestrian detour turns left or right.</i>		
Shape and size	rectangle 900 x 500 mm		
Background	orange (Rf)		
Border	black 25 mm		
Legend	Description	Colour	Size
	'arrow pointing left or right (as appropriate)' beside	black	shaft 30 mm
	'pedestrian symbol'	black	240 x 360 mm

W5-7.12	Pedestrian direction indicators – left (right) veer		
	<i>Pedestrian detour veers left or right.</i>		
Shape and size	rectangle 900 x 500 mm		
Background	orange (Rf)		
Border	black 25 mm		
Legend	Description	Colour	Size
	‘arrow pointing diagonally left or right (as appropriate)’ beside	black	shaft 30 mm
	‘pedestrian symbol’	black	240 x 360 mm
W5-7.13	Pedestrian direction indicators – straight ahead		
	<i>Pedestrian detour goes straight ahead.</i>		
Shape and size	rectangle 900 x 500 mm		
Background	orange (Rf)		
Border	black 25 mm		
Legend	Description	Colour	Size
	‘arrow pointing up’ beside	black	shaft 30 mm
	‘pedestrian symbol’	black	240 x 360 mm
W5-8.11	Cycle direction indicators – 90° left (right) turn		
	<i>Cycle detour turns left or right.</i>		
Shape and size	rectangle 900 x 500 mm		
Background	orange (Rf)		
Border	black 25 mm		
Legend	Description	Colour	Size
	‘arrow pointing left or right (as appropriate)’ beside	black	shaft 30 mm
	‘cycle symbol’	black	420 x 240 mm

W5-8.12	Cycle direction indicators – left (right) veer		
	<i>Cycle detour veers left or right.</i>		
Shape and size	rectangle 900 x 500 mm		
Background	orange (Rf)		
Border	black 25 mm		
Legend	Description	Colour	Size
	‘arrow pointing diagonally left or right (as appropriate)’ beside	black	shaft 30 mm
	‘cycle symbol’	black	420 x 240 mm

W5-8.13	Cycle direction indicators – straight ahead		
	<i>Cycle detour goes straight ahead.</i>		
Shape and size	rectangle 900 x 500 mm		
Background	orange (Rf)		
Border	black 25 mm		
Legend	Description	Colour	Size
	‘arrow pointing up’ beside	black	shaft 30 mm
	‘cycle symbol’	black	420 x 240 mm

W6 Incident warning

W6-1	Accident		
	<i>Accident ahead (for use by Police only).</i>		
Shape and size	rectangle 850 x 250 mm		
Background	orange (Rf)		
Border	black 20 mm		
Legend	Description	Colour	Size
	‘ACCIDENT’	black	100/16

W6-2	Fire		
	<i>Fire ahead (for use by a fire service only).</i>		
Shape and size	rectangle 850 x 250 mm		
Background	orange (Rf)		
Border	black 20 mm		
Legend	Description	Colour	Size
	‘FIRE’	black	100/16

W6-3	Emergency		
	<i>An emergency ahead (for use by an emergency service only).</i>		
Shape and size	rectangle 850 x 250 mm		
Background	orange (Rf)		
Border	black 20 mm		
Legend	Description	Colour	Size
	'EMERGENCY'	black	100/16
W6-4	Warning triangle		
	<i>Vehicle disabled, accident or hazard ahead. May be installed by any person (see 4.2(9)).</i>		
Shape and size	triangle with equal sides 325 mm long		
Background	none or white		
Border	red (R) 37 mm		
W6-5	Crash		
	<i>There has been a crash ahead. The maximum speed limit is 20 km/h until clear of the crash. (For use by emergency services personnel involved in dealing with the crash only)</i>		
Shape and size	rectangle 850 x 250 mm divided into two panels: left panel 600 x 250 mm; right panel 250 x 250 mm		
Background	left panel orange (Rf); right panel white (R)		
Border	left panel black 20 mm; right panel none		
Legend	Description	Colour	Size
	left panel 'CRASH'	black	100/15.5
	right panel R1-1	roundel red (R)	diameter 250 mm width 40 mm
	speed limit '20'	black	85/14
W6-6	Breakdown		
	<i>Breakdown ahead (For use by a worker involved in removing the temporary hazard caused by a breakdown)</i>		
Shape and size	rectangle 900 x 300 mm		
Background	orange (Rf)		
Border	black 25 mm		
Legend	Description	Colour	Size

	'BREAKDOWN'	black	125/18
--	-------------	-------	--------

W6-7 Emergency

There has been an incident ahead creating an emergency (for use by emergency services personnel involved in dealing with the emergency only; Police patrol car sign pack sign option).

Shape and size Rectangle 850 × 230mm

Background Orange (Rf)

Border Black 20mm

Legend	Description	Colour	Size
	'EMERGENCY'	black	100/17

W6-8 Checkpoint

Police checkpoint ahead (for use by the Police only; Police patrol car sign pack sign option).

Shape and size Rectangle 850 × 230mm

Background Orange (Rf)

Border Black 20mm

Legend	Description	Colour	Size
	'CHECKPOINT'	black	100/17

W6-9 Police operation

Police operation taking place ahead (for use by the Police only; Police patrol car sign pack sign option).

Shape and size Rectangle 850 × 230mm

Background Orange (Rf)

Border Black 20mm

Legend	Description	Colour	Size
	'POLICE OPERATION'	black	100/15.5

W6-10 All HMV stop

All Heavy Motor Vehicles (HMV) are required to stop (For use by the Police only. Heavy motor vehicle means a motor vehicle that has a gross vehicle mass exceeding 3500kg. Police patrol car sign pack sign option).

Shape and size Rectangle 850 × 230mm

Background White (R)

Border Red (R) 20mm

Legend	Description	Colour	Size
	“ALL HMV STOP”	black	100/15.5

W6-11 Road closed

Road Closed ahead (For use by emergency services personnel dealing with the relevant incident only; Police patrol car sign pack sign option).

Shape and size Rectangle 850 × 230mm

Background White (R)

Border Red (R) 20mm

Legend	Description	Colour	Size
	“ROAD CLOSED”	black	100/15.5

W7 Other temporary warning signs

W7-1 Vehicle mounted sign – pilot car follow me

Drivers follow the vehicle. Used to guide and control traffic through road works.

Shape and size rectangle 900 x 450 mm

Background orange (Rf)

Border black 25 mm

Legend	Description	Colour	Size
	‘PILOT CAR’	black	100/17
	‘FOLLOW ME’	black	100/14

W7-2 Vehicle mounted sign – road work

The vehicle is involved with work on road – pass with care.

Shape and size rectangle 900 x 450 mm

Background orange (RF)

Border black 25 mm

Legend	Description	Colour	Size
	‘ROAD’	black	160/40
	‘WORK’	black	160/40

W7-3	Vehicle mounted sign – road inspection		
	<i>The driver of the vehicle is involved in inspection of the road – pass with care. The vehicle may slow or stop.</i>		
Shape and size	rectangle 900 x 450 mm		
Background	orange (RF)		
Border	black 25 mm		
Legend	Description	Colour	Size
	‘ROAD’	black	125/19.5
	‘INSPECTION’	black	125/18
W7-4	Vehicle mounted sign – pass with care		
	<i>Vehicle involved with work on road – pass with care. Normally installed alongside other warning signs.</i>		
Shape and size	rectangle 900 x 450 mm		
Background	orange (RF)		
Border	black 25 mm		
Legend	Description	Colour	Size
	‘PASS WITH’	black	125/19.5
	‘CARE’	black	125/21
W7-5	Cement splashes wash car today		
	<i>Vehicle will be splashed by cement – you should wash your car today.</i>		
Shape and size	rectangle 1200 x 800 mm		
Background	orange (Rf)		
Border	black 25 mm		
Legend	Description	Colour	Size
	‘CEMENT’	black	150/21
	‘SPLASHES’	black	150/21
	‘WASH CAR TODAY’	black	100/15.5

W7-5.1	Lime splashes wash car today		
	<i>Vehicle will be splashed by lime – you should wash your car today.</i>		
Shape and size	rectangle 1200 x 800 mm		
Background	orange (Rf)		
Border	black 25 mm		
Legend	Description	Colour	Size
	‘LIME’	black	150/21
	‘SPLASHES’	black	150/21
	‘WASH CAR TODAY’	black	100/15.5
W7-6	Dry your brakes		
	<i>Used after section of road with flooding (in conjunction with W2-1.1).</i>		
Shape and size	rectangle 900 x 450 mm		
Background	orange (Rf)		
Border	black 25 mm		
Legend	Description	Colour	Size
	‘DRY YOUR’	black	125/18
	‘BRAKES	black	160/22.5
W7-7	Thank you		
	<i>Thank you.</i>		
Shape and size	rectangle 900 x 300 mm		
Background	orange (Rf)		
Border	black 25 mm		
Legend	Description	Colour	Size
	‘THANK YOU’	black	125/18
W7-7.1	Works end thank you		
	<i>The road works have ended.</i>		
Shape and size	rectangle 900 x 450 mm		
Background	orange (Rf)		
Border	black 25 mm		
Legend	Description	Colour	Size
	‘WORKS END’	black	125/18
	‘THANK YOU’	black	125/18

W7-8	General temporary warning		
	<i>Drivers should take the appropriate action indicated by the sign.</i>		
Shape and size	rectangle sized to suit message requirements		
Background	orange (Rf) or white (R)		
Border	black 25 mm		
Legend	Description	Colour	Size
	‘[such words as are necessary to convey the information to traffic in the least number of lines of text]’	black	120/18.7 (urban), 160/24.5 (rural)

W7-8.1	General temporary warning – variable message		
	<i>Drivers should take the appropriate action indicated by the sign.</i>		
Shape and size	rectangle sized to suit message requirements		
Background	black (unlit)		
Border	none		
Legend	Description	Colour	Size
	‘[such words as are necessary to convey the information to traffic in no more than 3 lines of text per screen and no more than 2 screens of text. If 2 screens are used the text must alternate between the 2 and not scroll between them]’	yellow (lit) or white (lit)	effective 200/31

Warning – Permanent

W10 Advance warning of traffic control devices

W10-1	Stop ahead		
	<i>There is a Stop sign ahead at distance specified.</i>		
Shape and size	diamond 600 mm square [with W10-1.1 supplementary]		
Background	yellow (R)		
Border	black 25 mm		
Legend	Description	Colour	Size
	‘octagon’	red (R)	400 mm wide symbol
	with border	white (R)	15 mm

W10-1.1 Distance ahead supplementary

The warning applies the stated distance beyond the sign.

Shape and size rectangle 600 x 250 mm

Background yellow (R)

Border black 25 mm

Legend	Description	Colour	Size
	'[distance] m'	black	numeral 100/15.5, 'm' 65/16

W10-2		Give-way ahead	
<i>There is a Give-way sign ahead at distance specified.</i>			
Shape and size	diamond 600 mm square [with W10-1.1 supplementary]		
Background	yellow (R)		
Border	black 25 mm		
Legend	Description	Colour	Size
	‘equilateral triangle apex pointing downward’ surrounded by	white (R)	sides 380 mm long
	‘band’ and	red (R)	38 mm
	‘border’	white (R)	10 mm
W10-3		Speed limit ahead	
<i>There is a speed limit ahead at the specified distance.</i>			
Shape and size	diamond 600 mm square [with W10-1.1 supplementary]		
Background	yellow (R)		
Border	black 15 mm		
Legend	Description	Colour	Size
	R1-1 or R1-1.1 sign with appropriate speed limit	red (R), white (R) and black	450 mm diameter
	with optional border	white (R)	10 mm
W10-4		Traffic signals ahead	
<i>Traffic signals ahead.</i>			
Shape and size	diamond 750 mm square		
Background	yellow (R)		
Border	black 25 mm		
Legend	Description	Colour	Size
	‘symbol of traffic signals’	black with red (R), yellow (R) green (R) circular inserts	420 x 615 mm, circles 95 mm diameter

W10-4.1	<i>(Revoked)</i>
----------------	------------------

W10-4.2	<i>(Revoked)</i>
----------------	------------------

W10-5	Advance warning traffic signals
--------------	--

A combination sign and signal to warn of the likelihood of the need to stop because of queues or a traffic signal ahead. See 6.5(5) to 6.5(10).

Shape and size	W10-4 traffic signal ahead sign; OR W11-1, W11-2 or other permanent warning sign depicting the feature generating the queue with a 200 mm diameter yellow circle aspect signal above and below supplemented by a W10-5.1, 5.2 or 5.3 sign as required
-----------------------	---

Legend	Description	Colour	Size
	'PREPARE'	black	100/15.5
	'TO STOP'	black	100/15.5

Legend	Description	Colour	Size
	'HIDDEN'	black	100/15.5
	'QUEUE'	black	100/15.5

Legend	Description	Colour	Size
	'QUEUED'	black	100/15.5
	'VEHICLES'	black	100/15.5

W10-6.1 Ramp signal on – variable

Advises drivers that signals that operate periodically on the ramp they are about to enter, or the ramp they are travelling on, are operating. See 6.4(17).

Shape and size rectangle 1675 x 950 mm

Background black (unlit)

Border black 60 mm

Legend	Description	Colour	Size
	‘RAMP’	yellow (lit) or white (lit)	effective 175/25
	‘SIGNAL’	yellow (lit) or white (lit)	effective 175/25
	‘ON’	yellow (lit) or white (lit)	effective 175/25

W10-6.2 Ramp signal off – variable

Advises drivers that signals that operate periodically on the ramp they are about to enter, or the ramp they are travelling on, are not operating. See subclause 6.4(17). May operate as an alternative to a W10-6.1 or W10-6.3.

Shape and size rectangle 1675 x 950 mm

Background black (unlit)

Border black 60 mm

Legend	Description	Colour	Size
	‘RAMP’	yellow (lit) or white (lit)	effective 175/25
	‘SIGNAL’	yellow (lit) or white (lit)	effective 175/25
	‘OFF’	yellow (lit) or white (lit)	effective 175/25

W10-6.3 Prepare to stop – variable

Advises drivers that signals that operate periodically on the ramp they are travelling on are operating and they may be required to stop for the signals or a queue that has formed. May operate as an alternative to a W10-6.2 display.

Shape and size rectangle 1675 x 950 mm

Background black (unlit)

Border black 60 mm

Legend	Description	Colour	Size
	‘PREPARE’	yellow (lit) or white (lit)	effective 175/25
	‘TO STOP’	yellow (lit) or white (lit)	effective 175/25

W11 Intersection**W11-1 Roundabout**

Roundabout ahead.

Shape and size diamond 600 mm square

Background yellow (R)

Border black 25 mm

Legend	Description	Colour	Size
	‘symbol three circulating arrows’	black	shaft 60 mm within 440 mm diameter circle

W11-2 Crossroads junction controlled – priority route ahead

Crossroad ahead – side road controlled by Stop or Give Way.

Shape and size diamond 600 mm square

Background yellow (R)

Border black 25 mm

Legend	Description	Colour	Size
	‘up arrow with line forming cross’	black	shaft 100 mm, line 60 mm wide

W11-2.1	Crossroads junction controlled – priority route turns		
	<i>Crossroad ahead – priority route turns and side roads controlled.</i>		
Shape and size	diamond 600 mm square		
Background	yellow (R)		
Border	black 25 mm		
Legend	Description	Colour	Size
	‘arrow turns left or right, cross formed by lines’	black	shaft 100 mm, lines 60 mm wide
W11-3	T-junction controlled		
	<i>T-junction ahead, priority route turns and side road controlled.</i>		
Shape and size	diamond 600 mm square		
Background	yellow (R)		
Border	black 25 mm		
Legend	Description	Colour	Size
	‘arrow turns left or right, T formed by line’	black	shaft 100 mm, line 60 mm wide
W11-3.1	T-junction uncontrolled		
	<i>T-junction ahead, no controls.</i>		
Shape and size	diamond 600 mm square		
Background	yellow (R)		
Border	black 25 mm		
Legend	Description	Colour	Size
	‘T formed by lines’	black	lines 100 mm wide
W11-3.2	Intersection sign supplementary – concealed		
	<i>The intersection ahead is concealed.</i>		
Shape and size	rectangle 800 x 250 [supplements W11 series signs where appropriate]		
Background	yellow (R)		
Border	black		
Legend	Description	Colour	Size
	‘CONCEALED’	black	100/14

W11-4	Side road junction – controlled		
	<i>Side road ahead controlled.</i>		
Shape and size	diamond 600 mm square		
Background	yellow (R)		
Border	black 25 mm		
Legend	Description	Colour	Size
	‘up arrow, with side road indicated by line on appropriate side of shaft’	black	shaft 100 mm, line 60 mm wide
W11-4.1	Side road junction – uncontrolled		
	<i>Side road uncontrolled.</i>		
Shape and size	diamond 600 mm square		
Background	yellow (R)		
Border	black 25 mm		
Legend	Description	Colour	Size
	‘vertical line with side road indicated by line on appropriate side’	black	lines 100 mm wide
W11-5	Y-junction – controlled		
	<i>Y-junction controlled.</i>		
Shape and size	diamond 600 mm square		
Background	yellow (R)		
Border	black 25 mm		
Legend	Description	Colour	Size
	‘arrow veering left or right with side road’ indicated by	black	shaft 100 mm,
	‘line on appropriate side of shaft’	black	line 60 mm wide
W11-5.1	Y-junction – uncontrolled		
	<i>Y-junction uncontrolled.</i>		
Shape and size	diamond 600 mm square		
Background	yellow (R)		
Border	black 25 mm		
Legend	Description	Colour	Size
	‘Y formed by lines’	black	lines 100 mm wide

W11-6	Merging traffic		
	<i>There is traffic merging ahead.</i>		
Shape and size	diamond 600 mm square		
Background	yellow (R)		
Border	black 25 mm		
Legend	Description	Colour	Size
	‘up arrow joined by line at 45° from left or right’	black	shaft 90 mm, line 90 mm wide
W11-6.1	Merging traffic		
	<i>There is traffic merging ahead.</i>		
Shape and size	diamond 1200 mm square		
Background	yellow (R)		
Border	black 45 mm		
Legend	Description	Colour	Size
	‘symbol of an arrow with two shafts merging into one’	black	450 x 750 mm, shafts 180 mm
W11-7	Lane gain		
	<i>The road ahead has an additional lane so an entering driver does not have to merge at the entry point to the road.</i>		
Shape and size	diamond 900 mm square		
Background	yellow (R)		
Border	black 45 mm		
Legend	Description	Colour	Size
	‘Two up arrows, one curved’ separated by	black	shaft 100 mm
	‘a symbolic lane line’	black	line tapers 30 mm at top to 200 mm at bottom, 1000 mm high

W12 Alignment

W12-1.1	Sharp curve – approximately 90°		
	<i>There is an approximately right angle curve ahead.</i>		
Shape and size	diamond 600 mm square		
Background	yellow (R)		
Border	black 25 mm		
Legend	Description	Colour	Size
	‘arrow depicting right angle turn’	black	shaft 90 mm
W12-1.2	Curve 15° to 90°		
	<i>There is a 15° to 90° curve ahead.</i>		
Shape and size	diamond 600 mm square		
Background	yellow (R)		
Border	black 25 mm		
Legend	Description	Colour	Size
	‘arrow depicting 15° to 90° curve’	black	shaft 90 mm
W12-1.3	Curve 90° to 120°		
	<i>There is a 90° to 120° curve ahead</i>		
Shape and size	diamond 600 mm square		
Background	yellow (R)		
Border	black 25 mm		
Legend	Description	Colour	Size
	‘arrow depicting 90° to 120° curve’	black	shaft 90 mm
W12-1.4	Curve greater than 120°		
	<i>There is a curve greater than 120° ahead</i>		
Shape and size	diamond 600 mm square		
Background	yellow (R)		
Border	black 25 mm		
Legend	Description	Colour	Size
	‘arrow depicting curve greater than 120°’	black	shaft 90 mm

W12-2.1	Reverse curves – less than 60°		
	<i>There is a reverse curve of less than 60° ahead.</i>		
Shape and size	diamond 600 mm square		
Background	yellow (R)		
Border	black 25 mm		
Legend	Description	Colour	Size
	‘arrow depicting a reverse curve of less than 60°’	black	shaft 90 mm
W12-2.2	Reverse curves – greater than 60°		
	<i>There is a reverse curve of more than 60° ahead.</i>		
Shape and size	diamond 600 mm square		
Background	yellow (R)		
Border	black 25 mm		
Legend	Description	Colour	Size
	‘arrow depicting a reverse curve of more than 60°’	black	shaft 90 mm
W12-2.3	Reverse curves – decreasing radii		
	<i>There is a reverse curve with decreasing radii ahead.</i>		
Shape and size	diamond 600 mm square		
Background	yellow (R)		
Border	black 25 mm		
Legend	Description	Colour	Size
	‘arrow depicting a reverse curve with decreasing radii’	black	shaft 90 mm
W12-2.4	Reverse curves – less than 1 km in extent		
	<i>There is a series of reverse curves ahead.</i>		
Shape and size	diamond 600 mm square		
Background	yellow (R)		
Border	black 25 mm		
Legend	Description	Colour	Size
	‘arrow depicting a series of reverse curves’	black	shaft 90 mm

W12-3.1	Curve sign supplementary – next ‘[distance]’ km		
	<i>There is a distance of winding road ahead specified by the supplementary sign.</i>		
Shape and size	rectangle 950 x 300 mm [supplements only W12-2.4]		
Background	yellow (R)		
Border	black 25 mm		
Legend	Description	Colour	Size
	‘NEXT [distance] km’	black	‘NEXT’ 100/14, numeral 150/21, ‘km’ 75/19

W12-3.2	Curve sign supplementary – advisory speed		
	<i>The curve ahead has an advisory speed of the value indicated.</i>		
Shape and size	rectangle 950 x 300 mm [supplements W12-1 or W12-2 series signs]		
Background	yellow (R)		
Border	black 25 mm		
Legend	Description	Colour	Size
	‘advisory speed in km/h’	black	200/34

W12-3.3	Curve sign supplementary – concealed		
	<i>The curve ahead has an entrance or intersection that is concealed.</i>		
Shape and size	rectangle 800 x 250 mm [supplements W12-1 or W12-2 series signs]		
Background	yellow (R)		
Border	black 25 mm		
Legend	Description	Colour	Size
	‘CONCEALED’	black	100/14
	‘arrow of the W12-1 or W12-2 series sign has line added in appropriate position to indicate location of concealed entrance’	black	line 60 mm wide

W12-4	Truck advisory speed		
	<i>The curve ahead has an advisory speed for heavy motor vehicles of the value indicated in km/h.</i>		
Shape and size	rectangle 1500 x 3000 mm		
Background	yellow (R)		
Border	black 50 mm		
Legend	Description	Colour	Size
	‘tilting truck symbol’ above	black	1130 x 1400 mm
	‘arrow indicating direction of curve’	black	shaft 220 mm
	‘[speed in km/h]’	black	400/68
W12-5	Exit advisory speed		
	<i>The motorway or expressway exit has curve with advisory speed of the value indicated.</i>		
Shape and size	rectangle 1400 x 1400 mm		
Background	yellow (R)		
Border	black 40 mm		
Legend	Description	Colour	Size
	‘EXIT’	black	200/31
	‘SPEED’	black	200/31
	‘[speed in km/h]’	black	300/51
W13	Road width or height		
W13-1	Road narrows – left or right side		
	<i>Road reduces in width from either left or right (as indicated).</i>		
Shape and size	diamond 750 mm square		
Background	yellow (R)		
Border	black 25 mm		
Legend	Description	Colour	Size
	‘symbol of road narrowing left or right’	black	240 x 420 mm

W13-1.1	Road narrows – both sides		
	<i>Road reduces in width, both sides narrow.</i>		
Shape and size	diamond 750 mm square		
Background	yellow (R)		
Border	black 25 mm		
Legend	Description	Colour	Size
	‘symbol of road narrowing both sides’	black	240 x 420 mm
W13-1.2	Road narrows ahead – supplementary		
	<i>The warning applies the stated distance beyond the sign.</i>		
Shape and size	rectangle 600 x 250 mm [supplements W13-1 or 13-2]		
Background	yellow (R)		
Border	black 25 mm		
Legend	Description	Colour	Size
	‘[distance] m’	black	numeral 100/15.5 ‘m’ 65/16
W13-1.3	Road narrows – two lanes reduce to one		
	<i>The number of lanes in the direction of travel reduces from two to one beyond the sign.</i>		
Shape and size	diamond 600 mm square		
Background	yellow (R)		
Border	black 25 mm		
Legend	Description	Colour	Size
	‘symbol of two lanes reducing to one’	black	260 x 390 mm
W13-1.4	Road narrows – three lanes reduce to two		
	<i>The number of lanes in the direction of travel reduces from three to two beyond the sign.</i>		
Shape and size	diamond 600 mm square		
Background	yellow (R)		
Border	black 25 mm		
Legend	Description	Colour	Size
	‘symbol of three lanes reducing to two’	black	340 x 390 mm

W13-2	Narrow bridge		
	<i>There is a narrow bridge ahead.</i>		
Shape and size	diamond 600 mm square		
Background	yellow (R)		
Border	black 25 mm		
Legend	Description	Colour	Size
	‘symbol of narrow bridge (left and right facing square brackets)’	black	340 x 440 mm
W13-2.1	Caution wide vehicles supplementary		
	<i>The bridge ahead is narrow, large vehicles are likely to encroach onto your side.</i>		
Shape and size	rectangle 750 x 600 mm		
Background	yellow (R)		
Border	black 25 mm		
Legend	Description	Colour	Size
	‘CAUTION’	black	100/15.5
	‘WIDE’	black	100/15.5
	‘VEHICLES’	black	100/15.5
W13-3	Low overhead clearance advance warning		
	<i>There is a structure with a height (specified on the sign) restriction ahead.</i>		
Shape and size	diamond 600 mm square		
Background	yellow (R)		
Border	black 25 mm		
Legend	Description	Colour	Size
	‘[vertical clearance] m’ between	black	numeral 150/23, ‘m’ 75/19
	‘two arrow heads’	black	shaft 80 mm
W13-4	Low overhead clearance – indication on structure or tunnel		
	<i>The vertical clearance for this structure is restricted to the height specified.</i>		
Shape and size	rectangle 900 x 600 mm		
Background	yellow (R)		
Border	black 25 mm		

Legend	Description	Colour	Size
	'[vertical clearance] m' above	black	numeral 200/31, 'm' 100/25
	'downward facing arrow'	black	shaft 60 mm

W13-5 Overhead electric cable

The height restriction is due to overhead electric cables.

Shape and size diamond 600 mm square [always supplemented by R5-4]

Background yellow (R)

Border black 25 mm

Legend	Description	Colour	Size
	'symbol of a lightning bolt coming from an insulator'	black	400 x 640 mm

W13-6 Tunnel

There is a tunnel (or bridge structure with limited space) ahead.

Shape and size diamond 600 mm square

Background yellow (R)

Border black 25 mm

Legend	Description	Colour	Size
	'symbol of a tunnel portal'	black	360 x 320 mm

W14 Other road-related hazard
W14-1 Diverge

The road diverges (both sides of an island or structure).

Shape and size diamond 600 mm square

Background yellow (R)

Border black 25 mm

Legend	Description	Colour	Size
	'downward diagonal arrows facing left and right'	black	shafts 80 mm

W14-2 Two-way

The road is two way.

Shape and size diamond 600 mm square

Background yellow (R)

Border black 25 mm

Legend	Description	Colour	Size
	'parallel up arrow and down arrows'	black	shafts 80 mm
<hr/>			
W14-2.1	Two-way [distance] ahead supplementary		
	<i>The warning applies the stated distance beyond the sign.</i>		
Shape and size	rectangle 600 x 250 mm [supplements W14-2]		
Background	yellow (R)		
Border	black 25 mm		
Legend	Description	Colour	Size
	'[distance] m'	black	numeral 100/15.5, 'm' 65/16
<hr/>			
W14-3	Sudden dip		
	<i>There is a sudden dip in the road ahead.</i>		
Shape and size	diamond 600 mm square		
Background	yellow (R)		
Border	black 25 mm		
Legend	Description	Colour	Size
	'symbol of a dip'	black	560 x 120 mm

W14-4	Hump		
	<i>There is a hump on the road ahead.</i>		
Shape and size	diamond 600 mm square		
Background	yellow (R)		
Border	black 25 mm		
Legend	Description	Colour	Size
	‘symbol of a hump’	black	560 x 160 mm
W14-5	Uneven surface		
	<i>The road ahead has an uneven surface.</i>		
Shape and size	diamond 600 mm square		
Background	yellow (R)		
Border	black 25 mm		
Legend	Description	Colour	Size
	‘symbol with two humps’	black	560 x 160 mm
W14-6	Slips/falling debris		
	<i>The road ahead is prone to slips or falling debris.</i>		
Shape and size	diamond 600 mm square		
Background	yellow (R)		
Border	black 25 mm		
Legend	Description	Colour	Size
	‘symbol of debris falling from bank’	black	600 x 450 mm
W14-7	Slippery surface		
	<i>The road may be slippery.</i>		
Shape and size	diamond 600 mm square		
Background	yellow (R)		
Border	black 25 mm		
Legend	Description	Colour	Size
	‘symbol of car skidding’	black	520 x 480 mm

W14-7.1	Supplementary – slow when frosty		
	<i>Warns road users to slow down to avoid the danger of skidding due to the frosty road surface.</i>		
Shape and size	rectangle 600 x 600 mm [supplements W14-7]		
Background	yellow (R)		
Border	black 15 mm		
Legend	Description	Colour	Size
	‘SLOW’	black	100/18
	‘WHEN’	black	100/16
	‘FROSTY’	black	100/16
W14-7.2	Supplementary – slow when wet		
	<i>Warns road users to slow down to avoid the danger of skidding due to the wet road surface.</i>		
Shape and size	rectangle 600 x 600 mm [supplements W14-7]		
Background	yellow (R)		
Border	black 15 mm		
Legend	Description	Colour	Size
	‘SLOW’	black	100/18
	‘WHEN’	black	100/18
	‘WET’	black	100/18
W14-7.3	Supplementary gravel road		
	<i>The road may be slippery because it has a gravel surface.</i>		
Shape and size	rectangle 600 x 250 mm [supplements W14-7]		
Background	yellow (R)		
Border	black 25 mm		
Legend	Description	Colour	Size
	‘GRAVEL’	black	100/14
	‘ROAD’	black	100/14
W14-7.4	Gravel road		
	<i>Metal surface (loose stones) ahead.</i>		
Shape and size	diamond 600 mm square		
Background	yellow (R)		
Border	black 15 mm		
Legend	Description	Colour	Size

	'symbol of car throwing up stones at oncoming car with broken window'	black	500 x 240 mm
<hr/>			
W14-8	Other hazard		
	<i>A hazard, described by a supplementary sign, exists beyond the sign.</i>		
Shape and size	diamond 600 mm square		
Background	yellow (R)		
Border	black 25 mm		
Legend	Description	Colour	Size
	'symbol of an exclamation mark'	black	180 x 590 mm
<hr/>			
W14-8.1	Other hazard supplementary – ford		
	<i>There is a ford ahead.</i>		
Shape and size	rectangle 600 x 250 mm [supplements W14-8]		
Background	yellow (R)		
Border	black 25 mm		
Legend	Description	Colour	Size
	'FORD'	black	100/15.5
<hr/>			
W14-8.2	Other hazard supplementary – cattle stop		
	<i>There is a cattle stop ahead.</i>		
Shape and size	rectangle 600 x 400 mm [supplements W14-8]		
Background	yellow (R)		
Border	black 25 mm		
Legend	Description	Colour	Size
	'CATTLE'	black	100/15.5
	'STOP'	black	100/15.5
<hr/>			
W14-8.3	Other hazard supplementary – gate		
	<i>There is a gate ahead.</i>		
Shape and size	rectangle 600 x 250 mm [supplements W14-8]		
Background	yellow (R)		
Border	black 25 mm		
Legend	Description	Colour	Size
	'GATE'	black	100/15.5
<hr/>			

W14-9	Steep grade down – ‘percent’ symbol		
	<i>There is a steep down grade ahead with the slope indicated by percentage.</i>		
Shape and size	diamond 600 mm square		
Background	yellow (R)		
Border	black 25 mm		
Legend	Description	Colour	Size
	‘right-angle triangle with hypotenuse and ‘[number] %’ top left to bottom right’	black	400 x 250 mm
		black	numeral 150/26, ‘%’ 160/26

W14-9.1	Steep grade down – ‘car’ symbol		
	<i>There is a steep down grade ahead.</i>		
Shape and size	diamond 600 mm square		
Background	yellow (R)		
Border	black 25 mm		
Legend	Description	Colour	Size
	‘symbol of right-angle triangle with hypotenuse and car top left to bottom right’	black	420 x 300 mm

W14-9.2	Trucks use low gear		
	<i>The grade ahead requires trucks to use low gear.</i>		
Shape and size	rectangle 600 x 600 mm [supplements W14-9 or 9.1]		
Background	yellow (R)		
Border	black 25 mm		
Legend	Description	Colour	Size
	‘TRUCKS’	black	100/14
	‘USE LOW’	black	100/14
	‘GEAR’	black	100/14

W14-9.3	<i>(Revoked)</i>		
----------------	------------------	--	--

W14-9.4	Use low gear		
	<i>It is recommended all vehicles use low gear for grade ahead.</i>		
Shape and size	rectangle 600 x 600 mm [supplements W14-9 or 9.1]		
Background	yellow (R)		

Border	black 25 mm		
Legend	Description	Colour	Size
	‘USE’	black	100/17
	‘LOW’	black	100/17
	‘GEAR’	black	100/17

W14.10 Steep grade up – ‘percent’ symbol

There is a steep up grade ahead with the slope indicated by percentage.

Shape and size	diamond 600 mm square		
Background	yellow (R)		
Border	black 25 mm		
Legend	Description	Colour	Size
	‘right-angle triangle, hypotenuse and ‘[number] %’ bottom left to top right’	black	400 x 250 mm, numeral 150/26, ‘%’ 160/26

W14-10.1 Steep grade up – ‘car’ symbol

There is a steep up grade ahead.

Shape and size	diamond 600 mm square		
Background	yellow (R)		
Border	black 25 mm		
Legend	Description	Colour	Size
	‘symbol of right-angle triangle with hypotenuse and car bottom left to top right’	black	420 x 300 mm

W14-11 Keep left

Combination diamond-shaped warning sign above a supplementary message sign to remind drivers to keep to the left side of the road.

Warning sign

Shape and size	diamond 600 mm square		
Background	yellow (R)		
Border	black 15 mm		
Legend	Description	Colour	Size
	‘symbol depicting two cars travelling in opposite directions, separated by a centre-line’	black	400 x 600 mm

Supplementary sign**Shape and size** rectangle 600 x 400 mm**Background** yellow (R)**Border** black 15 mm

Legend	Description	Colour	Size
	'KEEP'	black	100/15.5
	'LEFT'		

W14-11 .1 Drive on left – when turning

Combination diamond-shaped warning sign above a supplementary message sign to remind drivers who are turning at an intersection or driveway to drive on the left side of the road.

Warning sign**Shape and size** diamond 600 mm square**Background** yellow (R)**Border** black 15 mm

Legend	Description	Colour	Size
	'two-headed arrow showing a left and right turn onto the correct side of a road with a centre-line'	black	620 x 480 mm

Supplementary sign**Shape and size** rectangle 600 x 400 mm**Background** yellow (R)**Border** black 15 mm

Legend	Description	Colour	Size
	'DRIVE'	black	100/14
	'ON LEFT'		

W14-12 Slow for blue frost markers

Slow down when the blue, frost-warning, pavement markers are flashing.

Shape and size rectangle 750 x 750 mm**Background** yellow (R)**Border** black 20 mm

Legend	Description	Colour	Size
	'SLOW FOR'	black	100/14
	'BLUE FROST'		
	'MARKERS'		

W15 Railway level crossing

W15-1 Railway crossing on side road – controlled junction

There is a railway level crossing beyond a controlled intersection ahead (either on a side road or on the main road).

Shape and size diamond 600 mm square

Background yellow (R)

Border black 25 mm

Legend	Description	Colour	Size
	‘symbol depicting the road layout with the controlled road or roads depicted by a line or lines (60 mm wide) and the main road by an arrow (shaft 100 mm) superimposed in the appropriate location by a symbol of a railway line’	black	within 530 x 500 mm

W15-1.1 Railway crossing on side road – uncontrolled junction

There is a railway level crossing beyond an uncontrolled intersection ahead.

Shape and size diamond 600 mm square

Background yellow (R)

Border black 25 mm

Legend	Description	Colour	Size
	‘symbol depicting the road layout with the roads depicted by lines (100 mm wide) superimposed in the appropriate location by a symbol of a railway line’	black	within 530 x 500 mm

W15-2 Railway crossing and curve ahead

There is a railway level crossing at a curve in the road ahead.

Shape and size diamond 600 mm square

Background yellow (R)

Border black 25 mm

Legend	Description	Colour	Size
	‘symbol depicting the road layout with the roads depicted by lines (100 mm wide) superimposed in the appropriate location by a symbol of a railway line’	black	within 530 x 500 mm

W15-2.1	Railway crossing at T-junction – uncontrolled junction		
	<i>There is a railway level crossing nearby on the intersecting road ahead (intersection uncontrolled).</i>		
Shape and size	diamond 600 mm square		
Background	yellow (R)		
Border	black 25 mm		
Legend	Description	Colour	Size
	‘symbol as for W11-3.1’ with a ‘symbolic railway line on the stem of the T’	black	500 x 480 mm
W15-3	Railway level crossing position indicator (crossbuck)		
	<i>There is a railway level crossing at or near where the sign is installed.</i>		
Shape and size	‘Crossbuck’ consisting of one board 1000 x 200 mm sloping downwards to the right at 30° in front of similar board of the same size sloping downwards to the left at 30°		
Background	white (R)		
Border	none		
Legend	Description	Colour	Size
	‘CROSSING’ on front board	black	135/21
	‘RAIL’ ‘WAY’ on rear board	black	135/21
W15-3.1	‘Crossbuck’ with optional target board		
	<i>There is a railway level crossing at or near where the sign is installed.</i>		
Shape and size	symbol of W15-3 on a rectangular ‘target’ board 1100 x 850 mm		
Background	red (R)		
Border	white (R)		
Legend	Description	Colour	Size
	‘symbol of W15-3’	as for W15-3	as for W15-3

W15-3.1A		‘Crossbuck’ on target board	
<i>There is a railway at or near where the sign is installed. This sign may only be used where private roads cross a railway line.</i>			
Shape and size	rectangle 750 x 500 mm		
Background	red (R)		
Border	white (R) 15 mm		
Legend	Description	Colour	Size
	‘CROSSING’ on a	black	95/14.8
	rectangle that is sloping at 30° downward to the right superimposed on a	white (R)	700 x 400 mm
	rectangle that is sloping at 30° downward to the left with the words	white (R)	700 x 400 mm
	‘RAIL’ and ‘WAY’	black	95/14.8
W15-3.1B		‘Crossbuck’ on target board with ‘[number of]’ tracks	
<i>There is a railway at or near where the sign is installed with 2 or more tracks (number specified on the sign). This sign may only be used where private roads cross a railway line.</i>			
Shape and size	rectangle 750 x 750 mm		
Background	red (R)		
Border	white (R) 15 mm		
Legend	Description	Colour	Size
	‘CROSSING’ on a	black	95/14.8
	rectangle that is sloping at 30° downward to the right superimposed on a	white (R)	700 x 400 mm
	rectangle that is sloping at 30° downward to the left with the words	white (R)	700 x 400 mm
	‘RAIL’ and ‘WAY’ above	black	95/14.8
	‘[number]’ on	black	100/14
	a panel above	white (R)	100 x 150 mm
	‘TRACKS’ on	black	75/10.5
	a panel	white (R)	130 x 350 mm

W15-3.2	Tramway level crossing position indicator (tramway crossbuck)		
	<i>There is a tramway crossing ahead at or near where this sign is installed.</i>		
Shape and size	‘Crossbuck’ consisting of one board 1000 x 200 mm sloping downward to the right at 30° in front of a similar board of the same size sloping downwards to the left at 30°.		
Background	white (R)		
Border	none		
Legend	Description	Colour	Size
	‘CROSSING’ on front board	black	135/21
	‘TRAM’ and ‘WAY’ on rear board	black	135/21
W15-3.2A	‘Tramway crossbuck’ with optional target board		
	<i>There is a tramway crossing ahead at or near where this sign is installed.</i>		
Shape and size	symbol of W15-3.2 on a rectangular ‘target’ board 1100 x 850 mm		
Background	red (R)		
Border	white (R)		
Legend	Description	Colour	Size
	Symbol of W15-3.2	black	135/21
W15-4	‘[number of]’ tracks supplementary		
	<i>Describes the number of railway tracks at the level crossing.</i>		
Shape and size	Panel A: rectangle 100 x 150 mm above Panel B: rectangle 350 x 130 mm		
Background	Panel A and Panel B: white (R)		
Border	Panel A and Panel B: none		
Legend	Description	Colour	Size
Panel A	‘[number of tracks]’	black	100/14
Panel B	‘TRACKS’	black	75/10.5
W15-5	Railway crossing ahead (steam engine) – left or right		
	<i>Level crossing ahead.</i>		
Shape and size	diamond 600 mm square		
Background	yellow (R)		
Border	black 25 mm		
Legend	Description	Colour	Size

	‘symbol of steam train (facing right for left side of road, left for right side of road)’	black	480 x 520 mm
--	---	-------	--------------

W15-6 Railway level crossing flashing signal controlled ahead

Level crossing ahead controlled by flashing signals.

Shape and size diamond 600 mm square

Background yellow (R)

Border black 25 mm

Legend	Description	Colour	Size
	‘symbol of ‘Crossbuck’ and pair of flashing signals mounted on a pole’	black	320 x 440 mm

W15-7 Look for trains supplementary

Reminder to look along tracks for trains.

Shape and size rectangle 600 x 600 mm

Background yellow (R)

Border black 25 mm

Legend	Description	Colour	Size
	‘LOOK’	black	100/15.5
	‘FOR’ between	black	100/15.5
	‘arrows facing left and right’	black	shaft 35 mm
	‘TRAINS’	black	100/15.5

W15-8.1 Railway level crossing alignment – substantially at right angles

Level crossing ahead crosses the road substantially at right angles.

Shape and size diamond 600 mm square

Background yellow (R)

Border black 25 mm

Legend	Description	Colour	Size
	‘vertical line crossed by a symbolic railway line at right angles’	black	line 80 mm wide railway line 100 mm wide

W15-8.2	Railway level crossing alignment – at an oblique angle		
	<i>Level crossing ahead crosses the road at an oblique angle.</i>		
Shape and size	diamond 600 mm square		
Background	yellow (R)		
Border	black 25 mm		
Legend	Description	Colour	Size
	‘vertical line crossed by a symbolic railway line at an angle appropriate to the site’	black	line 80 mm wide railway line 100 mm wide
W15-8.4	Controlled intersection beyond level crossing		
	<i>There is a controlled intersection beyond and within 30 m of a railway level crossing.</i>		
Shape and size	diamond 600 mm square		
Background	yellow (R)		
Border	black 25 mm		
Legend	Description	Colour	Size
	‘symbol as for W15-1’ rotated so side road depiction vertical with a ‘symbolic railway line’ on the side road	black	500 x 530 mm
W15-8.5	Uncontrolled intersection beyond level crossing		
	<i>There is an uncontrolled intersection beyond and within 30 m of a railway level crossing.</i>		
Shape and size	diamond 600 mm square		
Background	yellow (R)		
Border	black 25 mm		
Legend	Description	Colour	Size
	‘symbol as for W15-1.1’ rotated so side road depiction vertical with a ‘symbolic railway line’ on the side road	black	400 x 380 mm
W15-9	Light-rail vehicle crossing ahead		
	<i>There is a light-rail vehicle ahead.</i>		
Shape and size	diamond 600 mm square		
Background	yellow (R)		
Border	black 25 mm		

Legend	Description	Colour	Size
	'symbol of tram'	black	560 x 90 mm

W15-10 Exempt

Vehicles normally required to stop at the level crossing ahead are not required to do so unless required to give way to a rail vehicle. See clauses 9.4 and 9.5 of Land Transport (Road User) Rule 2004.

Shape and size rectangle 600 x 250 mm

Background yellow (R)

Border black 25 mm

Legend	Description	Colour	Size
	'EXEMPT'	black	100/14

W15-11 Rail tracks – cyclists take care

The level crossing ahead requires cyclists to take care.

Shape and size diamond 600 mm square

Background yellow (R)

Border black 25 mm

Legend	Description	Colour	Size
	'symbol of cyclist falling from cycle caught in rail track'	black	500 x 90 mm

W16 Pedestrian, cycle, horse
W16-1 Pedestrians

There are likely to be pedestrians ahead.

Shape and size diamond 600 mm square

Background yellow (R) or yellow-green (RF)

Border black 25 mm

Legend	Description	Colour	Size
	'symbol of pedestrian'	black	250 x 480 mm

W16-2	Pedestrian crossing		
	<i>There is a pedestrian crossing ahead.</i>		
Shape and size	diamond 600 mm square		
Background	yellow (R) or yellow-green (RF)		
Border	black 25 mm		
Legend	Description	Colour	Size
	'symbol of a pedestrian crossing'	black	600 x 460 mm
W16-3	Belisha beacon disc		
	<i>Installed to mark the end of a pedestrian crossing on a black and white striped pole.</i>		
Shape and size	circle 400 mm diameter		
Background	orange (RF)		
Border	none		
W16-4	Children		
	<i>There are likely to be child pedestrians ahead.</i>		
Shape and size	diamond 600 mm square		
Background	yellow (R) or yellow-green (RF)		
Border	black 25 mm		
Legend	Description	Colour	Size
	'symbol of two children'	black	440 x 360 mm
W16-4.1	Children flag sign		
	<i>There is a school crossing point ahead and a school patrol is operating. The sign detail is applied to a flexible material that allows it to move freely in the manner of a flag.</i>		
Shape and size	diamond 600 mm square		
Background	orange (F) or red (F)		
Border	black 25 mm		
Legend	Description	Colour	Size
	'symbol of two children'	black	600 x 460 mm

W16-5.1	School – supplementary		
	<i>The pedestrians or crossing is associated with a school.</i>		
Shape and size	rectangle 600 x 250 mm [supplements W16-2 or W16-4]		
Background	yellow (R) or yellow-green (RF) [same colour as the W16-2 or W16-4 sign being supplemented]		
Border	black 25 mm		
Legend	Description	Colour	Size
	‘SCHOOL’	black	100/14
W16-5.2	Kindergarten		
	<i>The pedestrians or crossing is associated with a kindergarten.</i>		
Shape and size	rectangle 600 x 250 mm [supplements W16-2 or W16-4]		
Background	yellow (R) or yellow-green (RF) [same colour as the W16-2 or W16-4 sign being supplemented]		
Border	black 25 mm		
Legend	Description	Colour	Size
	‘KINDERGARTEN’	black	75/9.5
W16-5.3	Aged		
	<i>The pedestrians are most likely to be older persons.</i>		
Shape and size	rectangle 600 x 250 mm [supplements W16-1]		
Background	yellow (R) or yellow-green (RF) [same colour as the W16-1 sign supplemented]		
Border	black 25 mm		
Legend	Description	Colour	Size
	‘AGED’	black	100/17
W16-6	School bus symbol		
	<i>The road is a school bus route or turning area (W16-6.1 or 6.2 sign describes which).</i>		
Shape and size	diamond 600 mm square		
Background	yellow (R) or yellow-green (RF)		
Border	black 25 mm		
Legend	Description	Colour	Size
	‘symbol of bus’ combined with ‘children symbol of W16-4’	black	550 x 500 mm

W16-6.1	School bus route		
	<i>Defines a school bus route.</i>		
Shape and size	rectangle 750 x 750 mm [supplements W16-6]		
Background	yellow (R) or yellow-green (RF) [same colour as the W16-6 sign being supplemented]		
Border	black 25 mm		
Legend	Description	Colour	Size
	‘SCHOOL’	black	125/18
	‘BUS’	black	125/18
	‘ROUTE’	black	125/18

W16-6.2	School bus turns		
	<i>Defines a school-bus turning point.</i>		
Shape and size	rectangle 750 x 750 mm [supplements W16-6]		
Background	yellow (R) or yellow-green (RF)		
Border	black 25 mm		
Legend	Description	Colour	Size
	‘SCHOOL’	black	125/18
	‘BUS’	black	125/18
	‘TURNS’	black	125/18

W16-7	Cyclists		
	<i>There are likely to be cyclists ahead.</i>		
Shape and size	diamond 600 mm square		
Background	yellow (R) or yellow-green (RF)		
Border	black 25 mm		
Legend	Description	Colour	Size
	‘symbol of cycle’	black	500 x 350 mm

W16-7.1	Cycle path crossing		
	<i>Drivers should look both ways for cyclists on the cycle path or shared path</i>		
Shape and size	Diamond 600mm square		
Background	Yellow-green (RF)		
Border	Black 15mm		

Legend	Description	Colour	Size
	“arrow (type A) pointing right” above	Black	Arrows: 210mm long, shaft 45mm
	“symbol of a cycle” above	Black	Cycle symbol: 450 x 290mm
	“arrow (type A) pointing left”	Black	
	Option: for a one-way path, either arrow may be omitted and the cycle symbol reversed so that the remaining arrow and the cycle symbol indicate the direction of travel.		

Legend	Description	Colour	Size
W16-8	Horse riders		
	<i>There are likely to be horse riders ahead.</i>		
Shape and size	diamond 600 mm square		
Background	yellow (R) or yellow-green (RF)		
Border	black 25 mm		
Legend	Description	Colour	Size
	‘symbol of a rider on a horse’	black	480 x 440 mm
W16-9	40 km/h Advisory School Zone		
	<i>The sign indicates to drivers that they are entering a school zone with an advisory maximum speed of 40 km/h whenever children are present in the zone. Signs must be installed on both sides of the road.</i>		
Shape and size	rectangle 900 x 1500 mm (speed limit \leq 70 km/h) 1200 x 2000 mm (speed limit $>$ 70 km/h)		
Background	yellow-green (RF)		
Border	black 20 mm (\leq 70 km/h) 30 mm ($>$ 70 km/h)		
Legend	Description	Colour	Size
	“SCHOOL” “ZONE” above	black	120/20.4 (\leq 70 km/h) 160/27.2 ($>$ 70 km/h)
	A horizontal line above	black	20 mm (\leq 70 km/h) 30 mm ($>$ 70 km/h)
	“40” above	black	225/38.2 (\leq 70 km/h) 300/51 ($>$ 70 km/h)

	“WHEN”	black	120/18.6 (≤ 70 km/h)
	“CHILDREN”		160/24.8 (> 70 km/h)
	“PRESENT”		

W16-9.1	School Zone Ends		
	<i>The sign indicates to drivers that they are leaving a school zone.</i>		
Shape and size	rectangle 800 x 800 mm (speed limit ≤ 70 km/h) 1200 x 1200 mm (speed limit > 70 km/h)		
Background	yellow-green (RF)		
Border	black 30 mm		
Legend	Description	Colour	Size
	“SCHOOL”	black	125/19.5 (≤ 70 km/h)
	“ZONE”		160/24.8 (> 70 km/h)
	“ENDS”		

W16-10	40km/h advisory – cyclists on narrow bridge		
	<i>Advises drivers to slow to 40km/h when cyclists are on the narrow bridge</i>		
	Option A (speed limit < 80km/h)		
Shape and size	Rectangle 900 × 1500mm		
Background	Yellow-green (RF)		
Border	black 20 mm		
Legend	Description	Colour	Size
	‘NARROW’	black	120/21.6
	‘BRIDGE’ above	black	120/21.6
	A horizontal black line above	black	20mm
	‘40’	black	225/40.5
	‘WHEN’	black	120/19.2
	‘CYCLISTS’	black	120/19.2
	‘PRESENT’	black	120/19.2
	Option B (speed limit ≥ 80km/h)		
Shape and size	Rectangle 1200 × 2000mm		
Background	Yellow-green (RF)		
Border	black 30 mm		
Legend	Description	Colour	Size
	‘NARROW’	black	160/28.8
	‘BRIDGE’ above	black	160/28.8
	A horizontal black line above	black	30mm

'40'	black	300/54
'WHEN'	black	160/25.6
'CYCLISTS'	black	160/25.6
'PRESENT'	black	160/25.6

W17 Vehicle mounted

W17-1.1 School bus – 'school bus'

Drivers must slow to 20 km/h if a bus has stopped to pick up or drop off children – clause 5.6 of Land Transport (Road User) Rule 2004.

Shape and size	rectangle 1200 x 400 mm
Background	yellow (F) or yellow-green (RF)
Border	black 25 mm

Legend	Description	Colour	Size
	'SCHOOL BUS'	black	150/21

W17-1.2 School bus – 'school'

Drivers must slow to 20 km/h if a bus has stopped to pick up or drop off children – clause 5.6 of Land Transport (Road User) Rule 2004.

Shape and size	rectangle 825 x 300 mm
Background	yellow (F) or yellow-green (RF)
Border	black 25 mm

Legend	Description	Colour	Size
	'SCHOOL'	black	150/21

W17-1.3 School bus – 'symbolic children' plus flashing lights

Drivers must slow to 20 km/h if a bus has stopped to pick up or drop off children, or if the bus is stopped and the lights on the sign are flashing – clause 5.6 of the Land Transport (Road User) Rule 2004.

At other times when the lights are flashing, drivers should slow down and be prepared to stop if necessary.

Shape and size	rectangle 570 x 500 mm
Background	black
Border	none

Legend	Description	Colour	Size
	'symbol of children as W16-4' with	yellow-green (RF)	450 x 400 mm
	'lights in the top left and top right of the sign that flash alternately at a rate of 1 Hertz'	yellow (lit) or if forward facing, white (lit)	effective diameter 90 mm

W17-1.4	School bus – ‘symbolic children’		
	<i>Drivers must slow to 20 km/h if a bus has stopped to pick up or drop off children – clause 5.6 of Land Transport (Road User) Rule 2004.</i>		
Shape and size	rectangle 570 x 500 mm		
Background	yellow-green (RF)		
Border	black 20 mm		
Legend	Description	Colour	Size
	‘symbol of children as W16-4’	black	400 x 360 mm

W17-2	Overdimension vehicles – danger slow down		
	<i>Warns the vehicle is overdimension and may occupy more space than normal vehicles.</i>		
Shape and size	rectangle 1100 x 600 mm		
Background	yellow-green (RF)		
Border	black 20 mm		
Legend	Description	Colour	Size
	‘DANGER’	black	200/28
	‘SLOW DOWN’	black	150/21

W17-3.1	Overdimension vehicles – wide load follows		
	<i>There is a vehicle carrying a wide load following this vehicle.</i>		
Shape and size	rectangle 1100 x 520 mm		
Background	yellow-green (RF)		
Border	black 20 mm		
Legend	Description	Colour	Size
	‘WIDE LOAD’	black	150/21
	‘FOLLOWS’	black	150/21

W17-3.2	Overdimension vehicles – wide load ahead		
	<i>There is a vehicle carrying a wide load ahead of this vehicle.</i>		
Shape and size	rectangle 1100 x 520 mm		
Background	yellow-green (RF)		
Border	black 20 mm		
Legend	Description	Colour	Size
	‘WIDE LOAD’	black	150/21
	‘AHEAD’	black	150/21

W17-4.1	Overdimension vehicles – house follows		
	<i>There is a vehicle carrying a house following this vehicle.</i>		
Shape and size	rectangle 1100 x 520 mm		
Background	yellow-green (RF)		
Border	black 20 mm		
Legend	Description	Colour	Size
	‘HOUSE’	black	150/21
	‘FOLLOWS’	black	150/21
W17-4.2	Overdimension vehicles – house ahead		
	<i>There is a vehicle carrying a house ahead of this vehicle.</i>		
Shape and size	rectangle 1100 x 520 mm		
Background	yellow-green (RF)		
Border	black 20 mm		
Legend	Description	Colour	Size
	‘HOUSE’	black	150/21
	‘AHEAD’	black	150/21
W17-5.1	Overdimension vehicles – long load follows		
	<i>There is a vehicle carrying a long load following this vehicle.</i>		
Shape and size	rectangle 1100 x 520 mm		
Background	yellow-green (RF)		
Border	black 20 mm		
Legend	Description	Colour	Size
	‘LONG LOAD’	black	150/21
	‘FOLLOWS’	black	150/21
W17-5.2	Overdimension vehicles – long load ahead		
	<i>There is a vehicle carrying a long load ahead of this vehicle.</i>		
Shape and size	rectangle 1100 x 520 mm		
Background	yellow-green (RF)		
Border	black 20 mm		
Legend	Description	Colour	Size
	‘LONG LOAD’	black	150/21
	‘AHEAD’	black	150/21

W17-6 Overdimension vehicles – pilot vehicle

The vehicle is a pilot for an oversize load. Drivers may be asked to pull over or stop to make way for the load or not to overtake the load. This sign is displayed only on the reverse side of a W17-2, W17-3.1, W17-3.2, W17-4.1, W17-4.2, W17-5.1 or W17-5.2 sign.

Option A

Shape and size rectangle 1100 x 520 mm

Background black

Border white (must be reflectorised for use at night) 12 mm

Legend	Description	Colour	Size
	‘PILOT’	white (must be reflectorised for use at night)	150/21
	‘VEHICLE’	white (must be reflectorised for use at night)	150/21

Option B

Shape and size rectangle 1100 x 520 mm

Background yellow-green (RF)

Border black 30 mm

Legend	Description	Colour	Size
	‘PILOT’	black	150/21
	‘VEHICLE’	black	150/21

W17-7 Oversize

The vehicle on which the sign is installed is oversize. The sign must be used in accordance with clause 6.11 of the Land Transport Rule: Vehicle Dimensions and Mass 2002.

Shape and size 1100 x 300 mm

Background yellow-green (sign must be reflectorised if used during hours of darkness, may also be fluorescent)

Border black 20 mm

Legend	Description	Colour	Size
	‘OVERSIZE’	black	150/21

W17-7.1		Oversize - option	
<i>The vehicle on which the sign is installed is oversize. The sign must be used in accordance with clause 6.11 of the Land Transport Rule: Vehicle Dimensions and Mass 2002.</i>			
Shape and size	two rectangles 550 x 300 mm – panel 1 mounted on the left when facing the oversize vehicle, panel 2 mounted on the right.		
Background	yellow-green (sign must be reflectorised if used during hours of darkness, may also be fluorescent)		
Border	black 20 mm		
Legend	Description	Colour	Size
	‘OVER’ [panel 1]	black	150/21
	‘SIZE’ [panel 2]	black	150/21

In addition to the W17 series of signs the following signs may also be installed on vehicles: R3-13, R3-13.2, W1-1, W1-1.3, W1-1.4, W1-1.5, W2-1.12, W2-1.13, W2-1.14, W2-1.15, W2-1.16, W2-1.17, W2-1.18, W3-4.1, W3-4.2, W4-9, W7-1, W7-2, W7-3, W7-4, W7-8.1

W18		Miscellaneous	
W18-1		Wind gusts	
<i>The area ahead is prone to wind gusts.</i>			
Shape and size	diamond 600 mm square		
Background	yellow (R)		
Border	black 25 mm		
Legend	Description	Colour	Size
	‘symbol of a wind sock’	black	440 x 360 mm
W18-2		Aircraft	
<i>Aircraft fly low over the road ahead.</i>			
Shape and size	diamond 600 mm square		
Background	yellow (R)		
Border	black 25 mm		
Legend	Description	Colour	Size
	‘symbol of a jet plane’	black	480 x 480 mm
W18-2.1		Helicopter	
<i>Helicopters fly low over road ahead</i>			
Shape and size	diamond 600 mm square		
Background	yellow (R)		

Border	black 25 mm		
Legend	Description	Colour	Size
	‘symbol of helicopter’	black	500 x 250 mm
W18-3.1	Stock – cattle		
	<i>There is likely to be wandering cattle ahead.</i>		
Shape and size	diamond 600 mm square		
Background	yellow (R)		
Border	black 25 mm		
Legend	Description	Colour	Size
	‘symbol of a cow’	black	440 x 320 mm
W18-3.2	Stock – sheep		
	<i>There are likely to be wandering sheep ahead</i>		
Shape and size	diamond 600 mm square		
Background	yellow (R)		
Border	black 25 mm		
Legend	Description	Colour	Size
	‘symbol of a sheep’	black	400 x 280 mm
W18-3.3	Stock – deer		
	<i>There is likely to be deer ahead.</i>		
Shape and size	diamond 600 mm square		
Background	yellow (R)		
Border	black 15 mm		
Legend	Description	Colour	Size
	‘symbol of a deer’	black	380 x 500 mm
W18-3.4	Wild animals – horses		
	<i>There is likely to be wandering horses ahead.</i>		
Shape and size	diamond 600 mm square		
Background	yellow (R)		
Border	black 15 mm		
Legend	Description	Colour	Size
	‘symbol of a wild horse’	black	440 x 320 mm

W18-3.5	Wild animals – seals		
	<i>There is likely to be seals on or adjacent to the road ahead.</i>		
Shape and size	diamond 600 mm square		
Background	yellow (R)		
Border	black 15 mm		
Legend	Description	Colour	Size
	‘symbol of a seal’	black	350 x 320 mm
W18-3.6	Wild animals – pukeko		
	<i>There is likely to be pukeko wandering on the road ahead.</i>		
Shape and size	diamond 600 mm square		
Background	yellow (R)		
Border	black 15 mm		
Legend	Description	Colour	Size
	‘symbol of a pukeko’	black	380 x 450 mm
W18-3.7	Wild animals – ducks		
	<i>There is likely to be ducks wandering on the road ahead.</i>		
Shape and size	diamond 600 mm square		
Background	yellow (R)		
Border	black 15 mm		
Legend	Description	Colour	Size
	‘symbol of a duck’	black	520 x 210 mm
W18-3.8	Wild animals – penguin		
	<i>There is likely to be penguin on the road ahead.</i>		
Shape and size	diamond 600 mm square		
Background	yellow (R)		
Border	black 15 mm		
Legend	Description	Colour	Size
	‘symbol of a penguin’	black	250 x 420 mm

W18-3.9	Wild animals – kiwi		
	<i>There is likely to be kiwi on the road ahead.</i>		
Shape and size	diamond 600 mm square		
Background	yellow (R)		
Border	black 15 mm		
Legend	Description	Colour	Size
	‘symbol of a kiwi’	black	450 x 350 mm

W18-3.10 Wild animals – kereru

Combination diamond-shaped warning sign above a supplementary message sign to warn drivers there is likely to be low flying kereru ahead.

Warning sign

Shape and size Diamond 600mm square

Background Yellow (R)

Border Black 15mm

Legend	Description	Colour	Size
	“Symbol depicting a kereru swooping low in front of a car”	Black	480 x 460mm

Supplementary sign

Shape and size Rectangle 600 x 400mm

Background Yellow (R)

Border Black 15mm

Legend	Description	Colour	Size
---------------	--------------------	---------------	-------------

	“SLOW FOR”	Black	80/11.2
	“KERERU”	Black	100/16
<hr/>			
W18-3.12	Wild animals - bittern		
	<i>Combination diamond-shaped warning sign above a supplementary message sign to warn drivers there is likely to be low flying bittern ahead.</i>		
	Warning sign		
Shape and size	Diamond 600mm square		
Background	Yellow (R)		
Border	Black 15mm		
Legend	Description	Colour	Size
	‘Symbol depicting a bittern in low horizontal flight in front of a car’	black	480 × 460mm
	Supplementary sign		
Shape and size	Rectangle 600 × 400mm		
Background	Yellow (R)		
Border	Black 15mm		
Legend	Description	Colour	Size
	‘SLOW FOR’	black	80/11.2
	‘BITTERN’	black	100/16
<hr/>			
W18-4	Trucks operate		
	<i>Trucks are likely to be entering, leaving or crossing the road ahead.</i>		
Shape and size	diamond 600 mm square		
Background	yellow (R)		
Border	black 25 mm		
Legend	Description	Colour	Size
	‘symbol of a truck’	black	450 x 240 mm
<hr/>			
W18-5	Fire station		
	<i>There is a fire station ahead.</i>		
Shape and size	diamond 600 mm square		
Background	yellow (R)		
Border	black 25 mm		
Legend	Description	Colour	Size
	‘symbol of a fire engine’	black	560 x 160 mm
<hr/>			

W18-6	Forklifts operate		
	<i>Forklifts are likely to be entering, leaving or crossing the road ahead.</i>		
Shape and size	diamond 600 mm square		
Background	yellow (R)		
Border	black 25 mm		
Legend	Description	Colour	Size
	'symbol of a fork lift'	black	480 x 480 mm

W19 General and symbolic signs

W19-1	General warning		
	<i>Drivers should take the appropriate action indicated by the sign.</i>		
Shape and size	rectangle sized to suit the message requirements		
Background	yellow (R)		
Border	black 25 mm		
Legend	Description	Colour	Size
	Such words as are necessary to convey the information to traffic in the least number of lines of text.	black	120/18.7 (urban) 160/24.5 (rural)

W19-1.1	General warning variable		
	<i>Drivers should take the appropriate action indicated by the sign.</i>		
Shape and size	rectangle sized to suit the message requirements		
Background	black		
Border	none		
Legend	Description	Colour	Size
	Such words as are necessary to convey the information to traffic in no more than 3 lines of text per screen and no more than 2 screens of text. If 2 screens are used the text must alternate between the 2 and not scroll between them.	yellow (lit) or white (lit)	Effective 200/31

W19-2.1	Symbolic warning – active LED		
	<i>The legend is illuminated when the nature of the risk depicted by the symbol or word message is present. The illumination may be activated by the detection of an approaching vehicle, environmental or other conditions which meets or exceeds preset parameters, or where warning of a temporary condition of the road ahead is required.</i>		
Shape and size	rectangle 700 x 1000 mm		

Background	black		
Border	black 50 mm		
Legend	Description	Colour	Size
	(optional) lights in the left and right hand top corners flash alternately; or if no text is displayed lights in the four corners of the rectangle where the bottom two flash alternately with the top two	orange (lit)	60 cm ² effective
	‘symbol’[one of those described below]	yellow (lit)	size maximised without distortion to fit display area of 600 x 480 mm
	(optional) ‘text’[related to symbol as shown below]	yellow (lit) or white (lit)	160/25 effective
Symbol		Text	
	‘person digging’ (as in W1-1)		text used in W1-1 series of supplementary signs
	‘exclamation mark’ (as in W2-1)		text used in W2-1 series of supplementary signs
	‘car skidding’ (as in W3-2 or W14-7)		‘ICE/GRIT’ or ‘SLOW DOWN’
	‘cow’ (as in W3-4.1 or W18-3.1)		‘PREPARE’
			‘TO STOP’
	‘sheep’ (as in W3-4.2 or W18-3.2)		‘PREPARE’
			‘TO STOP’
	‘person holding flag’ (as in W3-6)		‘STOP ON’
			‘REQUEST’
	‘depiction of changed lanes ahead’ (as in W4-1.1, W4-1.2, W4-1.3, W4-2.1 or W4-2.2)		‘[distance] m’ (as for sign W4-10)
	‘depiction of curve’ (as in W12-1 and W12-2 series)		‘advisory speed in km/h’ (as for sign W12-3.2) or ‘SLOW DOWN’
	‘arrow depicting the shape of the curve’ (as in W12-1 and W12-2 series signs) with a ‘symbol of a railway line superimposed in the appropriate location’		‘advisory speed in km/h’ (as for sign W12-3.2) or ‘SLOW DOWN’
	‘pedestrian’ (as in W16-1)		‘SLOW’
			‘DOWN’
	‘children’ (as in W16-4)		‘SCHOOL’
			‘ZONE’
	‘cyclist’ (as in W16-7)		‘SLOW’
			‘DOWN’
	‘rider on horse’ (as in W16-8)		‘SLOW’

	‘DOWN’
‘truck’ (as in W18-4)	‘SLOW’
	‘DOWN’

W19-2.2 Symbolic warning – active flashing light

The lights on the top corners are illuminated when the nature of the risk depicted by the symbol or word message is present.

Shape and size rectangle 700 x 900 mm

Background black

Border none

Legend	Description	Colour	Size
	‘lights in the left and right-hand, top corners’ flash alternately	orange (lit)	60 cm ² effective
	‘symbol’[one of those described below]	yellow (R) or yellow-green (RF) as detailed below	size maximised without distortion to fit display area of 600 x 480 mm
	‘text’[related to symbol as detailed below]	yellow (R) or yellow-green (RF) as detailed below	100/14

Symbol – yellow (R)

‘cow’ (as in W3-4.1 or W18-3.1)

‘sheep’ (as in W3-4.2 or W18-3.2)

‘depiction of curve’ (as in W12-1 and W12-2 series)

‘truck’ (as in W18-4)

Symbol – yellow-green (RF)

‘pedestrian’ (as in W16-1)

‘children’ (as in W16-4)

‘cyclist’ (as in W16-7)

‘rider on horse’ (as in W16-8)

Text – yellow (R)

‘PREPARE’

‘TO STOP’

‘PREPARE’

‘TO STOP’

‘advisory speed in km/h’ (as for sign W12-3.2)

‘SLOW’

‘DOWN’

Text – yellow-green (RF)

‘SLOW’

‘DOWN’

‘SCHOOL’

‘ZONE’

‘SLOW’

‘DOWN’

‘SLOW’

‘DOWN’

W20 Curves, delineation and hazard markers**W20-1 Chevron sight board – horizontal curve – black on yellow**

Curve with a recommended advisory speed occurs here. Two options.

Option A (urban)

Shape and size rectangle 1650 x 600 mm (2 chevron),
2350 x 600 mm (4 chevron)

Background yellow (R)

Border black 10 mm

Legend	Description	Colour	Size
	'[speed in km/h]' beside	black	numerals 300/51
	'2 or 4 chevrons in direction of curve'		175 mm horizontal width and spacing, 500 mm height

Option B (rural)

Shape and size rectangle 2530 x 900 mm (2 chevron),
3700 x 900 mm (4 chevron)

Background yellow (R)

Border black 10 mm

Legend	Description	Colour	Size
	'[speed in km/h]' beside	black	numerals 400/68
	'2 or 4 chevrons in direction of curve'		305 mm horizontal width and spacing, 760 mm height

W20-1.1 Chevron sight board – roundabout, white on black

Used on central island of roundabout.

Shape and size rectangle 1600 x 400 mm

Background black

Border none

Legend	Description	Colour	Size
	'4 chevrons pointing to left'		200 mm horizontal width and spacing, 400 mm height
	each chevron		
	central stripe	white	70 mm wide
	border	white (R)	35 mm wide

W20-1.2	Chevron sight board – at T-junction		
	<i>The road terminates at this point and drivers must turn either left or right.</i>		
Shape and size	rectangle 2400 x 600 mm (2 panels) 4800 x 600 mm (4 panels) [each panel 1200 x 600 mm]		
Background	black		
Border	none		
Legend	Description	Colour	Size
	1 or 2 panels in each direction. Each panel comprises 2 chevrons	white (R)	200 mm horizontal width and 400 mm spacing
W20-1.3	Chevron sight board – roundabout, black on yellow		
	<i>Used on central island of roundabout. Alternative to sign W20-1.1.</i>		
Shape and size	rectangle 1200 x 450 mm		
Background	yellow (R)		
Border	black 10 mm		
Legend	Description	Colour	Size
	4 ‘chevrons’ pointing to the left	black	each chevron 140 mm horizontal width and spacing, 400 mm high
W20-1.4	Chevron sight board – at T-junction, black on yellow		
	<i>The road terminates at this point and drivers must turn either left or right. Alternative to sign W20-1.2.</i>		
Shape and size	rectangle 3000 x 600 mm (4 chevrons each direction)		
Background	yellow (R)		
Border	black 20 mm		
Legend	Description	Colour	Size
	4 ‘chevrons’ pointing to the left and 4 ‘chevrons’ pointing to the right	black	each chevron 175 mm horizontal width and spacing, 500 mm high
W20-2	Chevron curve indicator – black on yellow		
	<i>Placed at intervals around a curve to indicate the direction and extent of the curve.</i>		
Shape and size	rectangle 450 x 600 mm (urban), 750 x 900 mm (rural)		

Background	yellow (R)		
Border	black 10 mm		
Legend	Description	Colour	Size
	1 'chevron'	black	horizontal width/ height respectively 175 mm/250 mm (urban) 305 mm/380 mm (rural)

W20-2.1	Chevron curve indicator – white on black		
	<i>Placed at intervals around a curve to indicate the direction and extent.</i>		
Shape and size	rectangle 300 x 450 mm (urban), 450 x 600 mm (rural)		
Background	black		
Border	none		
Legend	Description	Colour	Size
	1 'chevron'	white (R)	horizontal width and height respectively 150 mm/450 mm (urban) 225 mm/600 mm (rural)

W20-3.1	Edge marker post – no reflector		
	<i>Used to delineate the right side of the road on substantially straight sections.</i>		
Shape and size	post at least 900 mm high and 90 mm wide		
Background	white		
Border	none		
Legend	Description	Colour	Size
	red horizontal band mounted 150 mm below top of post	red	width of post x 150 mm

W20-3.1A	Edge marker post – no reflector		
	<i>Used to delineate the right side of the road on substantially straight sections:</i>		
	(i) <i>where a road has to be left in a temporary unsealed condition for a period and traffic cones are impractical; or</i>		
	(ii) <i>during winter where the road is subject to significant snow coverage and a white edge marker post would not be effective.</i>		
Shape and size	post at least 900 mm high and 90 mm wide		
Background	orange		
Border	none		
Legend	Description	Colour	Size
	red horizontal band mounted 150 mm below top of post	red	width of post x 150 mm

W20-3.2	Edge marker post – white reflector		
	<i>Used to delineate the left side of the road.</i>		
Shape and size	post at least 900 mm high and 90 mm wide		
Background	white		

Border	none		
Legend	Description	Colour	Size
	White vertical strip centralised on post and over red horizontal band of a W20-3.1 post	white (R)	40 x 450 mm

W20-3.2A **Edge marker post – white reflector**

Used to delineate the right side of the road on substantially straight sections:

- (i) *where a road has to be left in a temporary unsealed condition for a period and traffic cones are impractical; or*
- (ii) *during winter where the road is subject to significant snow coverage and a white edge marker post would not be effective.*

Shape and size post at least 900 mm high and 90 mm wide

Background orange

Border none

Legend	Description	Colour	Size
	white vertical strip centralised on post and over red horizontal band of a W20-3.1 post	white (R)	40 x 450 mm

W20-3.3 **Edge marker post – yellow reflector**

Used to delineate the right side of the road around curves.

Shape and size post at least 900 mm high and 90 mm wide

Background white

Border none

Legend	Description	Colour	Size
	yellow vertical strip mounted above and below red horizontal band of a W20-3.1 post	yellow (R)	40 mm x 130 mm

W20-3.3A **Edge marker post – yellow reflector**

Used to delineate the right side of the road around curves:

- (i) *where a road has to be left in a temporary unsealed condition for a period and traffic cones are impractical; or*
- (ii) *during winter where the road is subject to significant snow coverage and a white edge marker post would not be effective.*

Shape and size post at least 900 mm high and 90 mm wide

Background orange

Border none

Legend	Description	Colour	Size
	yellow vertical strip mounted above and below red horizontal band of a W20-3.1 post	yellow (R)	40 mm x 130 mm
<hr/>			
W20-4	Hazard marker		
	<i>Used to mark service poles and other isolated hazards.</i>		
Shape and size	rectangle 150 x 375 mm		
Background	black		
Border	none		
Legend	Description	Colour	Size
	2 circles mounted 50 mm from each end of the marker	white (R)	100 mm diameter
<hr/>			
W20-5.1	Bridge end marker post – left side white and black		
	<i>Used to mark the left side of bridges and similar end hazards.</i>		
Shape and size	rectangle 150 x 900 mm		
Background	black		
Border	none		
Legend	Description	Colour	Size
	3 white stripes diagonally at 45° from top left to bottom right at vertical spacing of 150 mm	white (R)	150 x 900 mm
<hr/>			
W20-5.2	Bridge end marker post – right side yellow and black		
	<i>Used to mark the right side of bridges and similar end hazards.</i>		
Shape and size	rectangle 150 x 900 mm		
Background	black		
Border	none		
Legend	Description	Colour	Size
	3 yellow stripes diagonally at 45° from top right to bottom left at vertical spacing of 150 mm	yellow (R)	150 x 900 mm

Advisory signs

A11 Advance direction

A11-1 Advance direction – word message

Advises road users direction to follow at intersection ahead to reach a specific locality.

Shape and size	rectangle sized to suit message		
Background	green (R) or blue (R)		
Border	white (R) 40 mm		
Legend	Description	Colour	Size
	'[Locality]' (lower case) above	white (R)	120/30
	'TURN LEFT' or 'TURN RIGHT'	white (R)	100/15.5
	beside or above '[distance] m'	white (R)	numerals 100/15.5, 'm' 65/16

A11-2 Advance direction – multiple locality

Advises road users direction to follow at intersection ahead to reach any one of a number of specific localities.

Shape and size	rectangle sized to suit message		
Background	green (R) or blue (R)		
Border	white (R) 40 mm		
Legend	Description	Colour	Size
	'[Locality 1]' (lower case) beside 'arrow aligned appropriately'	white (R) white (R)	120/30 shaft 70 mm
	'[Locality 2]' (lower case) beside 'arrow aligned appropriately'	white (R) white (R)	120/30 shaft 70 mm

Note: sign may include an A16 series route indicator symbol beside either locality name.

A11-3 Advance direction – stack

Advises road users direction to follow at intersection ahead to reach any one of a number of specific localities.

Shape and size	rectangle sized to suit message		
Background	green (R) or blue (R)		
Border	white (R) 40 mm		
Legend	Description	Colour	Size
	Sign separated into 2 or 3 panels by white (R) 25 mm lines.	white (R)	
	Each panel contains '[locality]' (lower case) beside	white (R)	letters 120/30
	'arrow aligned appropriately or multiple locality as for sign A11.2'	white (R)	shaft 70 mm

Note: sign may include an A16 series route indicator symbol beside or above any locality name.

A11-4	Advance direction – map		
	<i>Advises road users direction to follow at intersection ahead to reach any one of a number of specific localities.</i>		
Shape and size	rectangle sized to suit message		
Background	green (R) or blue (R)		
Border	white (R) 40 mm		
Legend	Description	Colour	Size
	‘[Locality]’ or ‘[multiple locality names]’ (lower case) positioned relative to a	white (R)	letters 120/30
	‘symbolic map of the intersection’		map depicted by lines at least 120 mm wide

Note: sign may include an A16 series route indicator symbol beside or above any locality name.

A11-5	Cycle route direction		
	<i>Advises cyclists direction to follow at intersection ahead to follow a named cycle route.</i>		
Shape and size	rectangle 300 x 600 mm split into three panels approximately 160, 200 and 220 mm high		
Background	top panel white (R), middle panel blue (R), bottom panel white (R)		
Border	blue (R) 10 mm		
Legend	Description	Colour	Size
	Top panel ‘arrow aligned appropriately’	blue (R)	shaft 30 mm
	Middle panel ‘cycle symbol’	white (R)	270 x 175 mm
	Bottom panel ‘[name of route]’ (capital letters)	blue (R)	40 Tpt Med
	‘CYCLE’	blue (R)	40 Tpt Med
	‘ROUTE’	blue (R)	40 Tpt Med

A11-6	Tsunami evacuation route		
	<i>Advises which route to follow in the event a warning of a tsunami is given.</i>		
Shape and size	rectangle 400 x 500 mm		
Background	blue (R)		
Border	white (R) 15 mm		
Legend	Description	Colour	Size
	‘tsunami evacuation route’ symbol comprised of a ‘wave’ and the words ‘TSUNAMI’	white (R)	300 mm diameter circle

	EVACUATION ROUTE' within a circle above		
	'car' symbol beside	white (R)	150 x 70 mm
	'arrow' aligned appropriately	white (R)	shaft 20 mm

A12 Advance lane designation

A12-1 Advance lane designation – word message

Advises road users which lane to enter at intersection ahead to reach a specific locality.

Shape and size rectangle sized to suit message

Background green (R) or blue (R)

Border white (R) 40 mm

Legend	Description	Colour	Size
	'[locality]' (lower case) above	white (R)	120/30
	'LEFT LANE', 'RIGHT LANE' or other descriptor of the lane	white (R)	100/15.5

A12-2 Advance lane designation – overhead

Advises road users which lane to enter at intersection ahead to reach a specific locality. The arrow is erected directly over the lane to which it refers.

Shape and size rectangle sized to suit message

Background green (R) or blue (R)

Border white (R) 40 mm

Legend	Description	Colour	Size
	'[locality]' (lower case) above	white (R)	120/30
	'arrow aligned* appropriately'	white (R)	shaft 65 mm

* Note: straight ahead is depicted by a downward-facing arrow.

A12-3		EXIT ONLY supplementary	
<i>Advises road users the lane does not continue beyond the exit and they should move to an adjacent lane as soon as they may safely do so unless leaving the road by the exit indicated.</i>			
Shape and size	rectangle panel (forming part of the total sign size) width sized to suit the sign being supplemented x 400 mm height		
Background	yellow (R)		
Border	white (R)		
Option A			
Legend	Description	Colour	Size
	‘EXIT ONLY’	black	200/31
Option B			
Legend	Description	Colour	Size
	‘downward-facing arrow’ between	black	shaft 160 mm
	‘EXIT’ and ‘ONLY’	black	250/39

A13 **Intersection direction**

A13-1		Intersection direction – arrow board	
<i>Advises road users direction to follow at an intersection to reach a specific locality.</i>			
Shape and size	rectangle with a pointed end (isosceles triangle, base the height of the rectangle, height approximately 40% of base) pointing in the direction of the locality length sized to suit message x 450 mm height		
Background	green (R) or blue (R)		
Border	white (R) 25 mm		
Legend	Description	Colour	Size
	‘[locality]’ (lower case) beside a	white (R)	160/40
	chevron parallel to, and located at, the pointed end of the sign	white (R)	chevron 350 mm high, stripe width 130 mm.

Note: sign may include an A16 route indicator symbol beside the locality name.

A13-1.1		Intersection direction – arrow board with distance	
<i>Advises road users direction to follow at an intersection to reach a specific locality and the distance to that locality.</i>			
Shape and size	rectangle with a pointed end (isosceles triangle, base the height of the rectangle, height approximately 40% of base) pointing in the direction of the locality length sized to suit message x 450 mm height		
Background	green (R) or blue (R)		
Border	white (R) 25 mm		
Legend	Description	Colour	Size
	‘[Locality]’ (lower case) beside a	white (R)	160/40
	chevron parallel to, and located at the pointed end of the sign with	white (R)	chevron 350 mm high, stripe width 130 mm
	‘[distance] km’ inserted after the locality name	white (R)	numeral 160/40, ‘km’ 160/40

A13-1.2		Intersection direction cycle route – arrow board	
<i>Advises cyclists direction to follow at an intersection to reach a specific locality.</i>			
Shape and size	rectangle with a pointed end (isosceles triangle, base the height of the rectangle, height approximately 40% of the base) pointing in the direction of the locality, length sized to suit message x 225 mm		
Background	white (R) for locality and chevron; blue (R) rectangle 330 mm x full height of sign for cycle symbol		
Border	blue (R) 10 mm		
Legend	Description	Colour	Size
	cycle symbol at the square end	white (R)	symbol 340 x 220 mm
	‘[locality]’ (lower case) beside a	blue (R)	120/30
	chevron parallel to, and located at, the pointed angular end of the sign	blue (R)	chevron 220 mm high, stripe width 90 mm.

A13-2 Intersection direction – arrow

Advises road users direction to follow at an intersection to reach a specific locality. Used where the road is not approximately at right angles to the approaching driver.

Shape and size rectangle sized to suit message

Background green (R) or blue (R)

Border white (R) 25 mm

Legend	Description	Colour	Size
	'[locality]' (lower case) beside	white (R)	160/40
	an arrow aligned appropriately	white (R)	shaft 68 mm

Note: sign may include an A16 series route indicator symbol beside the locality name.

A13-3 Intersection direction – arrow board two directions

Advises road users the direction to follow at an intersection to reach localities described.

Shape and size rectangle with a pointed end (isosceles triangle, base the height of the rectangle, height approximately 40% of base) at each end pointing in the direction of the localities length sized to suit message x 450 mm height

Background green (R) or blue (R)

Border white (R) 25 mm

Legend	Description	Colour	Size
	'[locality]' (lower case) beside a	white (R)	160/40
	chevron parallel to, and located at the pointed end of the sign separated by a gap 500 mm from the '[locality]' and chevron at the other end of the sign	white (R)	chevron 350 mm high, stripe width 130 mm

Note: sign may include an A16 series route indicator symbol beside the locality names.

A13-3.2 Intersection direction cycle route – arrow board two directions

Advises cyclists the direction to follow at an intersection to reach localities described.

Shape and size	rectangle with a pointed end (isosceles triangle, base the height of the rectangle, height approximately 40% of the base) at each end pointing in the direction of the localities, length sized to suit message x 480 mm height		
Background	white (R) for locality and chevron; blue (R) rectangle 330 mm x full height of sign for cycle symbol		
Border	blue (R) 20 mm		
Legend	Description	Colour	Size
	'[locality]' (lower case) beside a	blue (R)	120/30
	chevron parallel to, and located at, the one end of the sign separated by	blue (R)	chevron 220 mm high, stripe width 90 mm.
	a cycle symbol from the	white (R)	symbol 340 x 220 mm
	'[locality]' and	blue (R)	120/30
	chevron at the other end of the sign	blue (R)	chevron 220 mm high, stripe width 90 mm.

A13.4 Intersection direction – 'fingerboard'

Advises road users direction to follow at an intersection to reach a specific locality and may describe the distance to that locality.

Shape and size	rectangle 240 mm high, length to suit, with blunted triangular end		
Background	yellow (R)		
Border	none		
Legend	Description	Colour	Size
	'[locality]' (upper case) beside	black	120/18.7
	'[distance] km'	black	numerals 120/18.7, 'km' 105/26

A14 Street name

A14-1	Street name		
	<i>Advise road users of the name of street.</i>		
Shape and size	Rectangle sized to suit message		
Background	retroreflective material: <ul style="list-style-type: none"> • preferably of the same class as used for the lettering and any symbols on the sign • colour, most commonly blue (R), should provide a contrast ratio with the lettering and any symbols of between 5:1 and 50:1 		
Border	none required		
Legend	Description	Colour	Size
	‘[name of street]’ and may include: a symbol associated with the locality or historical significance of the street name; numbers indicating street addresses; chevron or other form of direction indicator	most commonly white (R), should provide a contrast ratio with the background of between 5:1 and 50:1	<i>main text:</i> upper case 100/14, lower case 100 mm Tpt Med. <i>street numbers:</i> 50 mm Tpt Med <i>chevrons:</i> formed by a 15 mm stripe or a solid block of colour; <i>symbols:</i> conform with 4.4(5)(a)

A15 Confirmation direction

A15-1	Confirmation direction		
	<i>Located beyond an intersection to reassure road users they are travelling toward the correct destination.</i>		
Shape and size	rectangle sized to suit message		
Background	green (R) or blue (R)		
Border	white (R) 40 mm		
Legend	Description	Colour	Size
	‘[locality]’ (lower case) beside	white (R)	<i>upper case:</i> 120/32,
	‘[distance] km’ (sign normally contains no more than 3 localities and distances)	white (R)	<i>lower case:</i> 120/32 ‘km’ 105/28

Note: sign may include an A16 series route indicator symbol above the locality name or names.

A15-2		Confirmation direction cycle route	
<i>Located beyond an intersection to reassure cyclists they are travelling toward the correct destination.</i>			
Shape and size	rectangle 300 x 350 mm split into two panels approximately 200 and 100 mm high		
Background	top panel blue (R), bottom panel white (R)		
Border	blue (R) 10 mm		
Legend	Description	Colour	Size
Top panel	cycle symbol	white (R)	250 x 160 mm
Bottom panel	'[locality]' beside '[distance in km]'	blue (R)	40/5.6

A16 **Route indicator symbol**

A16-1		State highway route indicators	
<i>An aid for road user navigation along state highways.</i>			
Shape and size	shield with flat top and two circular sides meeting at bottom in a cusp 280 x 280 mm on other signs, 390 x 390 mm as an individual sign		
Background	red (R)		
Border	white (R)		
Legend	Description	Colour	Size
	'[number]' may also	white (R)	numeral 120/18.7
	have a letter beside or below		letter 60/9.3

A16-2		Urban route indicators	
<i>An aid for road user navigation along urban routes.</i>			
Shape and size	shield with parallel sides and a pointed bottom 200 x 240 mm on other signs, 310 x 360 mm as an individual sign		
Background	white (R)		
Border	black		
Legend	Description	Colour	Size
	'[number]'	black	120/30

A16-3	Special heavy vehicle route – symbol		
	<i>An aid for road user navigation along a special heavy vehicle route.</i>		
Shape and size	rectangle 280 x 140 mm		
Background	blue (R)		
Border	none		
Legend	Description	Colour	Size
	‘symbol of heavy motor vehicle (truck)’	white (R)	280 x 140 mm

A17 Destination reached

A17-1	Place name		
	<i>Indicates to the road user the place reached.</i>		
Shape and size	rectangle length to suit message x 375 mm height		
Option A			
Background	green (R) or blue (R)		
Border	white (R)		
Legend	Description	Colour	Size
	‘[locality]’ (lower case)	white (R)	75/19 urban 120/30 rural
Option B			
Background	white (R)		
Border	black		
Legend	Description	Colour	Size
	‘[locality]’ (lower case)	black	75/19 urban 120/30 rural
Option C			
Background	black		
Border	white (R)		
Legend	Description	Colour	Size
	‘[locality]’ (lower case)	white (R)	75/19 urban 120/30 rural

A20 Motorist service signs

A20-S	Motorist service symbols
<i>Symbols indicating the type of service available to motorists that form part of a motorist service sign.</i>	
Shape and size	as described – dimensions relates to rectangle size used for layout on a sign
Background	blue
Border	none

A20-S1	Rest Area		
<i>Indicates an area is available that allows motorists to rest.</i>			
Legend	Description	Colour	Size
	‘symbol of a tree and table’	white	300 x 300 mm

A20-S2	Accommodation		
<i>Indicates a place where accommodation – hotel, motel, guest house, etc – available.</i>			
Legend	Description	Colour	Size
	‘symbol of a bed’	white	360 x 300 mm

A20-S3	Camping ground		
<i>Indicates a place where camping is provided.</i>			
Legend	Description	Colour	Size
	‘symbol of a tent’	white	360 x 300 mm

A20-S4	Caravan park		
<i>Indicates a place where caravans may park.</i>			
Legend	Description	Colour	Size
	‘symbol of a caravan’	white	360 x 300 mm

A20-S5	Camping ground and caravan park		
<i>Indicates a place where caravans may park and where camping is provided.</i>			
Legend	Description	Colour	Size
	‘symbol of a tent above a caravan’	white	240 x 300 mm

A20-S6	Motor fuel		
<i>Indicates a place where motor fuel – petrol, diesel, LPG, etc – is available.</i>			
Legend	Description	Colour	Size
	‘symbol of a petrol pump’	white	300 x 300 mm
A20-S7	Motor fuel and repairs		
<i>Indicates a place where motor fuel and motor repair service is available.</i>			
Legend	Description	Colour	Size
	‘symbol of a petrol pump above a spanner’	white	300 x 300 mm
A20-S8	Refreshments		
<i>Indicates a place where a cafeteria or other place serving light meals and drink is available.</i>			
Legend	Description	Colour	Size
	‘symbol of a cup and saucer’	white	360 x 300 mm
A20-S9	Meals		
<i>Indicates a place where a restaurant is available.</i>			
Legend	Description	Colour	Size
	‘symbol of crossed fork and spoon’	white	240 x 300 mm
A20-S10	Information centre		
<i>Indicates a place where tourist and other local information – information centre, information bay, information boards, town or district maps, etc – is available.</i>			
Legend	Description	Colour	Size
	symbol of an italic, lower case ‘i’	white	240 x 300 mm
A20-S11	Emergency medical services		
<i>Indicates a place where 24-hour emergency medical service is available.</i>			
Legend	Description	Colour	Size
	‘symbol of a cross’	white	300 x 300 mm

A20-S12	Public telephone		
	<i>Indicates a place where a telephone is available to members of the public.</i>		
Legend	Description	Colour	Size
	‘symbol of a telephone hand piece’	white	240 x 300 mm
A20-S13	Public toilet		
	<i>Indicates a place where a toilet facility is available to members of the public.</i>		
Legend	Description	Colour	Size
	‘symbol of woman and man separated by vertical line’	white	300 x 300 mm
A20-S14	Waste disposal point		
	<i>Indicates a place where camp waste may be dumped.</i>		
Legend	Description	Colour	Size
	‘symbol of camping van with arrow below it pointing to pit’	white	300 x 300 mm
A20-S15	Public parking area		
	<i>Indicates a place where parking is available to members of the public.</i>		
Legend	Description	Colour	Size
	‘P’	white	300 x 300 mm
A20-S16	Parking for heavy motor vehicles		
	<i>Indicates a place where parking is available for heavy motor vehicles.</i>		
Legend	Description	Colour	Size
	‘P’ above a symbol of an articulated heavy motor vehicle’	white	360 x 300 mm
A20-S17	Parking for heavy trailers		
	<i>Indicates a place where parking is available for heavy trailers.</i>		
Legend	Description	Colour	Size
	‘P’ above a symbol of a heavy, full trailer’	white	360 x 300 mm

A20-S18	Airfield		
	<i>Indicates an airfield.</i>		
Legend	Description	Colour	Size
	‘symbol of a jet aircraft’	white	300 x 300 mm
A20-S19	Boat ramp		
	<i>Indicates a place where boats can be towed to or from the water.</i>		
Legend	Description	Colour	Size
	‘symbol of a boat on a trailer on ramp and wavy lines’	white	360 x 300 mm
A20-S20	Wheelchair access		
	<i>Indicates a place where wheelchair access is provided.</i>		
Legend	Description	Colour	Size
	‘symbol of person in wheel chair’	white	240 x 300 mm
A20-S21	Park and ride		
	<i>Indicates a place where motorists park their vehicles to catch public transport (bus, train, tram or ferry).</i>		
Legend	Description	Colour	Size
	‘P’ alongside a ‘symbol of a train, bus, tram or boat as appropriate’	white	360 x 300 mm
A20-S22	Electric vehicle charging station		
	<i>Indicates a place where a charging station for electric vehicles is available.</i>		
Legend	Description	Colour	Size
	‘symbol of an electric plug and cable connected to a charging station with the letter ‘E’ above the letter ‘V’	white	300 x 300 mm

A21 Advance advisory – motorist service

Note: The A21 and A22 series signs are typical motorist service signs. They are described to provide examples and indicate colour combinations and common design elements of the signs.

A21-1		Single service – adjacent to road		
<i>Indicates a service is available on the side and distance beyond the sign specified.</i>				
Shape and size	rectangle 640 x 1000 mm			
Background	blue			
Border	white 25 mm			
Legend	Description	Colour	Size	
	‘A20-S symbol’	white	as for A20-S symbol	
	‘[distance] m’	white	numeral 120/18.7, ‘m’ 80/20	
	‘ON’	white	120/18.7	
	‘LEFT’ or ‘RIGHT’	white	120/18.7	
A21-2		Two or more services – adjacent to road		
<i>Indicates two or more services are available on the side and distance beyond the sign specified.</i>				
Shape and size	rectangle width to fit numbers of symbols x 830 mm height			
Background	blue			
Border	white			
Legend	Description	Colour	Size	
	2 or more ‘A20-S symbols’	white	as for A20-S symbol	
	‘[distance] m’	white	numeral 120/18.7, ‘m’ 80/20	
	‘ON LEFT’ or ‘ON RIGHT’	white	120/18.7	

A21-3	Single service – on a side road		
	<i>Indicates a service is available along a side road that is on the side and distance beyond the sign specified.</i>		
Shape and size	rectangle 640 x 1000 mm		
Background	blue		
Border	white 25 mm		
Legend	Description	Colour	Size
	‘A20-S symbol’	white	as for A20-S symbol
	‘TURN’	white	120/18.7
	‘LEFT’ or ‘RIGHT’	white	120/18.7
	‘[distance] m’	white	numeral 120/18.7, ‘m’ 80/20
A21-4	Two or more services – on a side road		
	<i>Indicates two or more services are available along a side road that is on the side and distance beyond the sign specified.</i>		
Shape and size	rectangle width to fit numbers of symbols x 830 mm height		
Background	blue		
Border	white		
Legend	Description	Colour	Size
	2 or more ‘A20-S symbols’	white	as for A20-S symbol
	‘TURN LEFT’ or ‘TURN RIGHT’	white	120/18.7
	‘[distance] m’	white	numeral 120/18.7, ‘m’ 80/20
A21-5	Next [service] [distance] km		
	<i>The next service indicated on the sign is the stated distance beyond the sign.</i>		
Shape and size	rectangle 900 x 1110 mm		
Background	blue (R)		
Border	white (R) 35 mm		
Legend	Description	Colour	Size
	‘NEXT’	white (R)	140/19.7
	‘A20-S1’ (rest area) or ‘A20-S6’ (motor fuel) symbol	white (R)	400 x 400 mm
	‘[distance] km’	white (R)	numeral 160/25 ‘km’ 105/26

A22 Position of motorist services

A22-1 Single service adjacent to road

Indicates where the service is available

Option A Chevron board

Shape and size rectangle with a pointed end (isosceles triangle, base the height of the rectangle, height approximately 40% of base) pointing in the direction of the service 900 x 450 mm

Background blue

Border white 25 mm

Legend	Description	Colour	Size
	'A20-S symbol' beside	white	as for A20-S symbol
	a chevron parallel to, and located at, the pointed end of the sign	white	chevron 330 mm high, stripe width 130 mm

Option B Arrow format

Shape and size rectangle, 450 x 790 mm

Background blue

Border white 25 mm

Legend	Description	Colour	Size
	'A20-S symbol' above	white	as for A20-S symbol
	'arrow pointing in appropriate direction'	white	shaft width 80 mm

A22-2		Two or more services adjacent to road	
<i>Indicates where the services are available.</i>			
Option A	Chevron board		
Shape and size	rectangle with a pointed end (isosceles triangle, base the height of the rectangle, height approximately 40% of base) pointing in the direction of the service length to fit the number of symbols x 450 mm height		
Background	blue		
Border	white 25 mm		
Legend	Description	Colour	Size
	2 or more 'A20-S symbols' beside a	white	as for A20-S symbols
	chevron parallel to, and located at, the pointed end of the sign	white	chevron 330 mm high, stripe width 130 mm
Option B	Arrow format		
Shape and size	rectangle, width 830 mm x height to fit the number of symbols used		
Background	blue		
Border	white 25 mm		
Legend	Description	Colour	Size
	2 or more 'A20-S symbols' in two columns above an	white	as for A20-S symbols
	'arrow pointing in the appropriate direction'	white	shaft width 80 mm
A22-3		Service or services on a side road	
<i>Indicates the side road along which the services are available and distance to travel.</i>			
Shape and size	rectangle with a pointed end (isosceles triangle, base the height of the rectangle, height approximately 40% of base) pointing in the direction of the service; length to fit the number of symbols plus distance x 450 mm height		
Background	blue		
Border	white 25 mm		
Legend	Description	Colour	Size
	As for A22-1A and A22-2A with	white	symbols and chevron as for A22-1A and A22-2A
	'[distance] km' inserted between chevron and 'A20-S symbol'	white	numeral 120/18.7 'km' 80/20

A30 Tourist signs

Note: The A31 to A36 series of signs are typical tourist and combined tourist/motorist service signs. They are described to provide examples and indicate colour combinations and common design elements of the signs.

A30-S Tourist feature symbols

Symbols for tourist feature signs to advise road users of the type of tourist feature.

Shape and size Shape as described, size is the minimum rectangular area used for the symbol on a sign.

Background Brown (R)

Border Each symbol includes a border of the same colour as the background within the dimensions specified for the symbol.

A-30-S1 Heritage New Zealand Pouhere Taonga site

Indicates a place of historical significance

Legend	Description	Colour	Size
	Symbol of an historic building above a Māori motif within a circle	White (R)	300 x 300mm (including a border around the symbol)

A-30-S2 Winery or vineyard

Indicates a winery or vineyard that is open to the public.

Legend	Description	Colour	Size
	Symbol of a bunch of grapes	White (R)	240 x 300mm (including a border around the symbol)

A-30-S3 Lookout

Indicates the location of a lookout or view point.

Legend	Description	Colour	Size
	Symbol of an adult looking through binoculars and a child pointing	White (R)	300 x 300mm (including a border around the symbol)
A-30-S4	Photography site		

Indicates a place where there is scenery or other photo-opportunity.

Legend	Description	Colour	Size
	Symbol of a camera	White (R)	300 x 300mm (including a border around the symbol)

A31 Advance advisory for tourist features

A31-1	Tourist feature or features		
	<i>Advises road users of tourist features adjacent to the road and the distance beyond the sign.</i>		
Option A	text		
Shape and size	rectangle width to suit message x 750 mm high (3 lines of text), 900 mm high (4 lines of text), 1050 mm high (5 lines of text) or 1200 mm high (6 lines of text)		
Background	Brown (R)		
Border	White (R) 25 mm		
Legend	Description	Colour	Size
	‘[Feature]’ or ‘[Features]’ (upper and lower case, up to 4 lines of text) above	White (R)	120/19.2
	‘[distance] m’ above	White (R)	Numerals 120/19.2, “m” Tpt Med ‘x’ height 80 mm
	‘ON LEFT’ or ‘ON RIGHT’	White (R)	120/19.2
Option B	symbols		
Shape and size	Rectangle 600 x 1000 mm (one symbol), 900 x 900 mm (2 symbols), 1300 x 900 mm (3 symbols), 1800 x 900 mm (4 symbols)		

Background	Brown (R)		
Border	White (R) 25 mm		
Legend	Description	Colour	Size
	Up to 4 'A30-S symbols' above	White (R)	Each symbol, including a border, maximised to fit an area 300 x 300 mm
	'[distance] m' above	White (R)	Numerals 120/19.2, "m" Tpt Med 'x' height 80 mm
	'ON' above 'LEFT' or 'RIGHT' (for signs with 1 symbol) or 'ON LEFT' or 'ON RIGHT' (for signs with 2, 3, or 4 symbols)	White (R)	120/19.2

A31-2 Combined tourist feature and motorist service

Advises road users directions to follow at intersection ahead to reach specific feature or service.

Shape and size	rectangle sized to suit message		
Background	two panels – tourist panel at top brown, motorist service panel at bottom blue separated by line, white 10 mm		
Border	white 25 mm		
Legend	Description	Colour	Size
	Tourist panel example:		
	'[feature]' (upper case)	white	letters and numerals 120/18.7
	'[distance] m ON LEFT'	white	'm' 80/20
	Motorist service:		
	1 or more 'A20-S symbols'	white	as for A20-S symbol

A31-3 Advance tourist features on side road

Advises road users of tourist features on a side road and which way to turn at the intersection the stated distance beyond the sign.

Option A	Text
Shape and size	Rectangle width to suit message x 750mm high (3 lines of text), 900mm high (4 lines of text), 1050mm high (5 lines of text) or 1200 mm high (6 lines of text)
Background	Brown (R)
Border	White (R) 25mm

Legend	Description	Colour	Size
	“[Feature]” or “[Features]” (upper and lower case, up to 4 lines of text) above	White (R)	120/19.2
	“TURN LEFT” or “TURN RIGHT” above	White (R)	120/19.2
	“[distance] m”	White (R)	Numerals 120/19.2, “m” Tpt Med ‘x’ height 80mm

Option B	Symbols
Shape and size	Rectangle 600 x 1000mm (1 symbol), 1200 x 900mm (2 symbols), 1300 x 900mm (3 symbols), 1800 x 900mm (4 symbols)
Background	Brown (R)
Border	White (R) 25mm

Legend	Description	Colour	Size
	Up to 4 “A30-S symbols” above	White (R)	Each symbol, including a border, maximised to fit an area 300 x 300mm
	“TURN” above “LEFT” or “RIGHT” (for signs with 1 symbol” or “TURN LEFT” or “TURN	White (R)	120/19.2

RIGHT” (for signs with 2, 3, or 4 symbols” above

“[distance] m”

White (R)

Numerals 120/19.2,
“m” Tpt Med ‘x’
height 80mm

A31-5 Next [tourist feature] [distance] km

The next tourist feature indicated on the sign is the stated distance beyond the sign.

Shape and size 600 x 900 mm

Background Brown (R)

Border White (R) 25mm

Legend	Description	Colour	Size
	“NEXT”	White (R)	120/19.2
	“A30-S3” lookout or “A30-S4” photography symbol	White (R)	Symbol, including a border, maximised to fit an area 300 x 300mm
	“[distance] km”	White (R)	Numerals 120/19.2, “km” Tpt Med ‘x’ height 80mm

A32 Position of tourist features

A32-1		Tourist feature adjacent to road	
<i>Indicates the location of a tourist feature</i>			
Option A	text		
Shape and size	rectangle with pointed end (isosceles triangle, base the height of the rectangle, height approximately 40% of the base), length to suit message x 450 mm high (1 line of text), 600 mm high (2 lines of text), 750 mm high (3 lines of text) or 900 mm high (4 lines of text)		
Background	Brown (R)		
Border	White (R) 25 mm		
Legend	Description	Colour	Size
	A chevron pointing in the direction of the feature, parallel to and located at the pointed end of the sign, beside:	White (R)	330 mm high, stripe width 130 mm (1 line of text), 440 mm high, stripe width 170 mm (2 lines of text), 520 mm high, stripe width 205 mm (3 lines of text), 680 mm high, stripe width 265 mm (4 lines of text)
	'[Feature]' or '[Features]' (upper and lower case, up to 4 lines of text)	White (R)	120/19.2
Option B	symbols		
Shape and size	rectangle with pointed end (isosceles triangle, base 450 mm, height 180 mm), length to suit the number of symbols x 450 mm height		
Background	Brown (R)		
Border	White (R) 25 mm		
Legend	Description	Colour	Size
	A chevron pointing in the direction of the feature, parallel to and located at the pointed end of the sign, beside:	White (R)	330 mm high, stripe width 130 mm
	Up to 4 'A30-S symbols'	White (R)	Each symbol, including a border, maximised to fit an area 300 x 300 mm

A32-2		Tourist feature on side road	
<i>Indicates the side road along which the feature is found and the distance to travel.</i>			
Option A	text		
Shape and size	rectangle with pointed end (isosceles triangle, base the height of the rectangle, height approximately 40% of the base), at one end pointing in the direction of the feature; length to fit the message x 450 mm high (1 line of text), 600 mm high (2 lines of text), 750 mm high (3 lines of text) or 900 mm high (4 lines of text)		
Background	Brown (R)		
Border	White (R) 25 mm		
Legend	Description	Colour	Size
	A chevron pointing in the direction of the feature, parallel to and located at the pointed end of the sign, beside	White (R)	330 mm high, stripe width 130 mm (1 line of text), 440 mm high, stripe width 170 mm (2 lines of text), 520 mm high, stripe width 205 mm (3 lines of text), 680 mm high, stripe width 265 mm (4 lines of text)
	'[distance] km]', beside	White (R)	Numerals 120/19.2, 'km' Tpt Med 'x' height 60 mm
	'[Feature]' or '[Features]' (upper and lower case, up to 4 lines of text)	White (R)	120/19.2
Option B	symbols		
Shape and size	rectangle with pointed end (isosceles triangle, base 450 mm, height 180 mm), length to suit the number of symbols and distance x 450 mm height		
Background	Brown (R)		
Border	White (R) 25 mm		
Legend	Description	Colour	Size
	A chevron pointing in the direction of the feature, parallel to and located at the pointed end of the sign, beside	White (R)	330 mm high, stripe width 130 mm
	'[distance] km]', beside	White (R)	Numerals 120/19.2, 'km' Tpt Med 'x' height 60 mm

Up to 4 ‘A30-S symbols’	White (R)	Each symbol, including a border, maximised to fit an area 300 x 300 mm
-------------------------	-----------	--

A32-3 Tourist feature adjacent to road – arrow format

Indicates the location of a tourist feature

Option A Text

Shape and size Rectangle width to suit message x 450 mm high (1 line of text), 600 mm high (2 lines of text), 750 mm high (3 lines of text) or 900 mm high (4 lines of text)

Background Brown (R)

Border White (R) 25 mm

Legend	Description	Colour	Size
	Arrow (type D) pointing in the appropriate direction beside	White (R)	Shaft 50 mm
	“[Feature]” or “[Features]” (upper and lower case, up to 4 lines of text)	White (R)	120/19.2

Option B Symbols

Shape and size Rectangle 450 x 900mm (1 symbol), 900 x 900mm (2 symbols), 900 x 1200mm (3 or 4 symbols)

Background Brown (R)

Border White (R) 25mm

Legend	Description	Colour	Size
	Up to 4 “A30-S symbols” above	White (R)	Each symbol, including a border, maximised to fit an area 300 x 300mm
	Arrow (type D) pointing in appropriate direction	White (R)	Shaft 80mm

A40 General information

A40-1	No exit		
	<i>Indicates the road is a cul de sac.</i>		
Shape and size	rectangle 600 x 600 mm		
Background	white (R)		
Border	black 20 mm		
Legend	Description	Colour	Size
	‘NO’	black	150/23
	‘EXIT’	black	150/23
A40-2	Turn left at any time with care		
	<i>Used at signalised intersections when a free flow left turn slip lane is provided.</i>		
Shape and size	rectangle 750 x 600 mm		
Background	white (R)		
Border	black		
Legend	Description	Colour	Size
	‘TURN’	black	100/17
	‘LEFT’	black	100/17
	‘AT ANY TIME’	black	80/11.2
	‘WITH CARE’	black	80/12.4
A40-3	Bells off (railway level crossing)		
	<i>Indicates railway level crossing alarm bells do not operate during specified times.</i>		
Shape and size	rectangle 600 x 750 mm		
Background	white (R)		
Border	black 20 mm		
Legend	Description	Colour	Size
	‘BELLS’	black	100/14
	‘OFF’	black	150/21
	‘[time] PM TO’	black	75/10.5
	‘[time] AM’	black	75/10.5

A40-5		Feeling sleepy? take a break	
<i>Recommends drivers stop if feeling tired. Sign must only be used where a rest area or service centre offering 24-hour provision of rest, comfort and refreshment exists within 1 km beyond sign.</i>			
Shape and size	rectangle 1680 x 535 mm		
Background	blue (R)		
Border	white (R) 25 mm		
Legend	Description	Colour	Size
	‘Feeling sleepy?’	white (R)	120/20
	‘TAKE A BREAK’	white (R)	140/21.5

A40-6		Roundabout may change signal	
<i>Traffic conditions at the roundabout ahead may change the signals above the sign. The signals are roundabout metering signals and the sign is required under subclause 6.4(15)(d).</i>			
Shape and size	rectangle 750 x 450 mm		
Background	white (R)		
Border	black 20 mm		
Legend	Description	Colour	Size
	‘ROUNDABOUT’	black	80/11.2
	‘MAY CHANGE’	black	80/11.2
	‘SIGNAL’	black	80/11.2

A40-7		Shared zone	
<i>The roadway beyond the sign is within a shared zone for the purposes of clause 10.2 of the Land Transport (Road User) Rule 2004.</i>			
Shape and size	rectangle 600 x 750 mm		
Background	blue (R)		
Border	white (R) 20 mm		
Legend	Description	Colour	Size
	“symbol of two children” beside	white (R)	160 x 135
	“symbol of pedestrian” both above	white (R)	90 x 150
	“symbol of cycle” beside	white (R)	160 x 100
	“symbol of car” both above	white (R)	120 x 100
	“SHARED”	white (R)	100/14
	“ZONE”	white (R)	100/14

A41 Road information

A41-1 Motorway

Advises road users they are on a motorway and rules applying to motorway use apply. The sign may also be used on an on-ramp to a motorway to indicate the motorway begins.

Note: A41-1 series motorway signs may include the name of the motorway. Vertical dimensions of the signs must be increased by the amount required to fit the name above the word 'MOTORWAY'.

Shape and size rectangle 1180 x 450 mm**Background** green (R)**Border** white (R)

Legend	Description	Colour	Size
	'MOTORWAY'	white (R)	150/21

A41-1.1 Motorway begins

Advises road users they are about to enter a motorway and rules applying to motorway use apply.

Shape and size rectangle 2400 x 1200 mm**Background** green (R)**Border** white (R)

Legend	Description	Colour	Size
	'MOTORWAY'	white (R)	250/39
	'BEGINS'	white (R)	250/39

A41-1.2 Motorway ends advance information

Advises road users the motorway ends in the specified distance.

Shape and size rectangle 2600 x 1200 mm**Background** green (R)**Border** white (R)

Legend	Description	Colour	Size
	'MOTORWAY'	white (R)	letters and numerals 250/39,
	'ENDS [distance] m'	white (R)	'm' 150/23

A41-1.3	Motorway ends		
	<i>Advises road users the motorway has ended and all normal road rules apply.</i>		
Option A	erected at the point where the motorway ends		
Shape and size	rectangle 2400 x 1200 mm		
Background	green (R)		
Border	white (R)		
Legend	Description	Colour	Size
	'MOTORWAY'	white (R)	250/39
	'ENDS'	white (R)	250/39
Option B	erected on an off-ramp from the motorway where the motorway ends		
Shape and size	rectangle 890 x 600 mm		
Background	green (R)		
Border	white (R)		
Legend	Description	Colour	Size
	'MOTORWAY'	white (R)	100/14
	'ENDS'	white (R)	150/21
A41-2	Expressway		
	<i>Advises road users they are on a road often with similar characteristics to, but that is not, a motorway. It may have special conditions applying to its use and these should be clearly signed. The sign may also be used on an on-ramp to an expressway to indicate the expressway begins. Note: A41-2 series expressway signs may include the name of the expressway. Vertical dimensions of the signs must be increased by the amount required to fit the name above the word 'EXPRESSWAY'.</i>		
Shape and size	rectangle 1350 x 450 mm		
Background	green (R) or blue (R)		
Border	white (R) 20mm		
Legend	Description	Colour	Size
	'EXPRESSWAY'	white (R)	150/21
A41-2.1	Expressway begins		
	<i>Advises road users they are about to enter an expressway.</i>		
Shape and size	rectangle 2760 x 1200 mm		
Background	green (R) or blue (R)		
Border	white (R) 20mm		
Legend	Description	Colour	Size
	'EXPRESSWAY'	white (R)	250/39
	'BEGINS'	white (R)	250/39

A41-2.2	Expressway ends advance information		
	<i>Advises road users the expressway ends in the specified distance.</i>		
Shape and size	rectangle 2760 x 1200 mm		
Background	green (R) or blue (R)		
Border	white (R) 20 mm		
Legend	Description	Colour	Size
	‘EXPRESSWAY’	white (R)	letters and numerals 250/39,
	‘ENDS [distance] m’	white (R)	‘m’ 150/23
A41-2.3	Expressway ends		
	<i>Advises road users the expressway has ended.</i>		
Option A	erected at the point where the expressway ends		
Shape and size	rectangle 2760 x 1200 mm		
Background	green (R) or blue (R)		
Border	white (R) 20 mm		
Legend	Description	Colour	Size
	‘EXPRESSWAY’	white (R)	250/39
	‘ENDS’	white (R)	250/39
Option B	erected on an off-ramp from the expressway where the expressway ends		
Shape and size	rectangle 990 x 600 mm		
Background	green (R) or blue (R)		
Border	white (R) 25 mm		
Legend	Description	Colour	Size
	‘EXPRESSWAY’	white (R)	100/14
	‘ENDS’	white (R)	150/21

A41-3		Construction zone	
<i>Indicates the beginning or end of a construction zone for the purposes of 11.5(4).</i>			
Shape and size	rectangle 450 x 300 mm		
Background	white (R)		
Border	black 15 mm		
Legend	Description	Colour	Size
	'CONSTRUCTION'	black	50/6
	'ZONE'	black	50/6
	'arrow to either left or right'	black	shaft 15 mm
A41-4		Railway not in use	
<i>Indicates the railway line is not in use and the normal requirements for road users at level crossings do not apply.</i>			
Shape and size	rectangle 1000 x 450 mm		
Background	white (R)		
Border	black 25 mm		
Legend	Description	Colour	Size
	'RAILWAY'	black	120/18.7
	'NOT IN USE'	black	120/18.7
A42		Lane information	
A42-1		Passing lane 400 m ahead	
<i>Indicates a passing lane exists 400 m beyond the sign to allow vehicles travelling in the same direction to pass.</i>			
Shape and size	rectangle 1125 x 1000 mm		
Background	white (R)		
Border	black		
Legend	Description	Colour	Size
	'PASSING'	black	120/30
	'LANE'	black	120/30
	'400 m'	black	numerals 150/37.5, 'm' 100/25
	'AHEAD'	black	120/30

A42-1.1	Passing lane '[distance] km' ahead		
	<i>Indicates a passing lane exists at a specified distance beyond the sign to allow vehicles travelling in the same direction to pass.</i>		
Shape and size	rectangle 1500 x 1350 mm		
Background	white (R)		
Border	black		
Legend	Description	Colour	Size
	'PASSING'	black	160/40
	'LANE'	black	160/40
	'[distance] km'	black	numerals 200/50, 'km' 135/34
	'AHEAD'	black	160/40
A42-2	Passing bay '[distance] m'		
	<i>Indicates a passing bay exists at a specified distance beyond the sign to allow vehicles travelling in opposite directions to pass.</i>		
Shape and size	rectangle 975 x 825 mm		
Background	white (R)		
Border	black, 25 mm		
Legend	Description	Colour	Size
	'PASSING'	black	150/21
	'BAY'	black	150/21
	'[distance] m'	black	numeral 150/21, 'm' Tpt Med 'x' height 100 mm
A42-3	Slow vehicle bays next '[distance] km'		
	<i>Indicates that there are a number of slow vehicle bays over a specified distance beyond the sign for slow vehicles to pull over to allow vehicles travelling in the same direction to pass.</i>		
Shape and size	rectangle 950 x 1100 mm		
Background	white (R)		
Border	black 15 mm		
Legend	Description	Colour	Size
	'SLOW'	black	120/20.1
	'VEHICLE'	black	120/18.7
	'BAYS'	black	120/20.1
	'NEXT'	black	120/20.1

	'[distance] km'	black	120/30
--	-----------------	-------	--------

A42-4 Slow vehicle bay '[distance] m'

Indicates a slow vehicle bay exists at a specified distance beyond the sign to allow slow vehicles to pull over to allow vehicles travelling in the same direction to pass

Shape and size rectangle 900 x 900 mm

Background white (R)

Border black 15 mm

Legend	Description	Colour	Size
	'SLOW'	black	120/20.1
	'VEHICLE'	black	120/18.7
	'BAY'	black	120/20.1
	'[distance] m'	black	120/30

A42-5 Slow vehicle bay indicator

Indicates start of a slow vehicle bay for slow vehicles to pull over to allow vehicles travelling in the same direction to pass.

Shape and size rectangle 900 x 900 mm

Background white (R)

Border black 15 mm

Legend	Description	Colour	Size
	'diagonal upward arrow'	black	arrow head 250 mm
	'SLOW'	black	120/20.1
	'VEHICLE'	black	120/18.7
	'BAY'	black	120/20.1

A42-6 Advance special vehicle lane

Advises road users that a special vehicle lane, reserved for the classes of vehicle shown on the sign, begins at the distance or location beyond the sign as indicated on a supplementary sign.

Shape and size Rectangle 600mm wide x height to suit the classes of vehicle

Background White (R)

Border 15mm black

Legend	Description	Colour	Size
--------	-------------	--------	------

“[TEXT or symbols]” describing the classes of vehicle (as detailed below) above	(as detailed below)	(as detailed below)
“LANE” or “ONLY”	Black	120/19.2

Details – text or symbols for A42-6 signs

The following symbols or text may be shown on A42-6 signs. If the lane is a transit lane, “TRANSIT” and the transit symbols should be shown above any other vehicle class.

Description	Colour	Size
“TRANSIT” above	Black	80/14.4
“T2 (or T3)” within	White (R)	80/14.4
“barrel-like shape” to the left of	Black	195 x 130mm
“symbol of car with 2 (or 3) occupants”	Black	175 x 150mm
“symbol of a bus (side on)”	Black	465 x 160mm
“symbol of a cycle”	Black	245 x 160mm
“E V” (abbreviation for electric vehicle)	Black	120/21.6
“symbol of a motorcycle”	Black	305 x 160mm
“symbol of a truck (side on)” may include “3.5 t” within the truck symbol	Black White (R)	320 x 160mm 60/9.6
“TAXI”	Black	100/16
“[TEXT]” to describe the class of vehicle	Black	100/16

A42-6.1 Advance special vehicle lane supplementary – [distance] m

Supplementary sign for use with A42-6 advance advisory special vehicle lane sign, to advise road users a special vehicle lane begins at the stated distance beyond the sign.

Shape and size Rectangle 600 x 250mm

Background White (R)

Border 15mm black

Legend	Description	Colour	Size
--------	-------------	--------	------

“[distance] m”	Black	Numerals 100/16 “m” Tpt Med ‘x’ height 70mm
----------------	-------	---

A42-6.2 Advance special vehicle lane supplementary – Ahead

Supplementary sign for use with A42-6 advance advisory special vehicle lane sign, to advise road users there is a special vehicle lane ahead.

Shape and size Rectangle 600 x 250mm

Background White (R)

Border 15mm black

Legend	Description	Colour	Size
	“AHEAD”	Black	100/16

A42-6.3 Advance special vehicle lane supplementary – On-ramp

Supplementary sign for use with A42-6 advance advisory special vehicle lane sign, to advise road users of the location of the special vehicle lane.

Shape and size Rectangle 600 x 250mm

Background White (R)

Border 15mm black

Legend	Description	Colour	Size
	“ON-RAMP”	Black	100/16

A43 Cyclist information

A43-1 Cyclists use left shoulder

Recommends cyclists use the shoulder rather than the motor vehicle lane.

Shape and size rectangle 750 x 600 mm

Background white (R)

Border	black 20 mm		
Legend	Description	Colour	Size
	‘symbol of cycle’	black	184 mm high
	‘USE LEFT’	black	80/13.5
	‘SHOULDER’	black	80/13.5

A43-2 Cyclists use ramp
Recommends cyclists use a ramp to avoid conflicts with high-speed following motor vehicles leaving at the ramp.

Shape and size	rectangle 600 x 1200 mm		
Background	white (R)		
Border	black 20 mm		
Legend	Description	Colour	Size
	‘symbol of cycle’	black	300 mm high
	‘USE’	black	140/21.5
	‘RAMP’	black	140/21.5
	‘diagonal upward to the left arrow’	black	shaft 50 mm

A43-3 Cyclists cross here with care
Recommends cyclists cross at this point (commonly on off-ramp away from diverging entry point).

Shape and size	rectangle 900 x 900 mm		
Background	white (R)		
Border	black 30 mm		
Legend	Description	Colour	Size
	‘symbol of cycle’	black	265 mm high
	‘CROSS HERE’	black	80/13.5
	‘WITH CARE’	black	80/13.5
	‘arrow’	black	shaft 25 mm

A43-4 NZ Cycle Trail (NZCT) symbol
A symbol used only on approved NZCT routes to guide cyclists and inform other road users.

Shape and size	rectangle 140 x 126 mm (symbol for small signs), 200 x 180 mm (symbol for large signs)		
Background	black		
Border	none		

Legend	Description	Colour	Size
	“symbol of cyclist and wheels”	white (R) with front wheel enclosing a red (R) circle	126 x 112 mm (small symbol) 180 x 160 mm (large symbol)

A43-5 Hook turn

Recommends cyclists make a hook turn manoeuvre to turn right at the next intersection.

Shape and size Rectangle 400 x 600mm

Background White (R)

Border Black 15mm

Legend	Description	Colour	Size
	“Symbol comprising two arrows (type A), separated by a gap, depicting a two-stage hook turn manoeuvre” above	Black	250 x 240mm (arrow shafts 21mm)
	“symbol of cycle” above	Black	185 x 120mm
	“HOOK”	Black	50/8
	“TURN”	Black	50/8

A43-6 Pass safely

Advises drivers to leave a safe gap when passing cyclists

Option A

Shape and size Rectangle 900 x 750mm

Background White (R)

Border Black 25mm

Legend	Description	Colour	Size
	“symbol of a cyclist and a car separate by a double ended dimension arrow (type B) above	Black	<i>Symbol:</i> 745 x 350mm <i>Arrow:</i> shaft 20mm

	“PASS SAFELY”	Black	120/16.8
Option B			
Shape and size	Rectangle 1200 x 900mm		
Background	White (R)		
Border	Black 40mm		
Legend	Description	Colour	Size
	“symbol of a cyclist and a car separate by a double ended dimension arrow (type B) and ‘1.5 m’ above	Black	<i>Symbol</i> : 1000 x 470mm <i>Arrow</i> : shaft 25mm “1.5”: 150/24 “m”: Tpt Med, ‘x’ height 100mm
	“PASS SAFELY”	Black	150/21

A43-7	Cyclists watch for traffic		
	<i>Advises cyclists to watch for traffic (typically where a cycle path or shared path crosses a road).</i>		
Shape and size	Rectangle 400 × 600mm		
Background	White (R)		
Border	Black 15mm		
Legend	Description	Colour	Size
	‘[symbol of cycle]’ above	black	270 × 175mm
	‘WATCH’	black	60/9.6
	‘FOR’	black	60/9.6
	‘TRAFFIC’	black	60/9.6

A43-8	Contra-flow cycle lane		
	<i>Advises road users that cyclists are permitted to travel in either direction in the adjacent cycle lane.</i>		
Shape and size	Rectangle 400 × 600mm		
Background	White (R)		
Border	Black 15mm		
Legend	Description	Colour	Size
	‘[symbol of cycle]’ above	black	300 × 195mm

‘[Two arrows (type A) side
by side, left arrow pointing
up and right arrow
pointing down]’

black Shaft 35mm

A43-4.1		NZ Cycle Trail (NZCT) logo	
<i>The logo used only to formally describe approved NZCT routes at their beginning or end.</i>			
Shape and size	rectangle 200 x 100 mm (logo for small signs), 300 x 150 mm (logo for large signs)		
Background	Panel A black, Panel B white		
Border	none		
Legend	Description	Colour	Size
	Panel A		
	‘symbol of cyclist and wheels’ to the left of	as for A43-4	86 x 77 mm (small logo) 133 x 120 mm (large logo)
	“Nga Haerenga” above	white (R)	8/1.6 upper case, 6/1.5 lower case (small logo) 12/2.4 upper case, 9/2.3 lower case (large logo)
	Panel B		
	“THE NEW ZEALAND CYCLE TRAIL”	black	10/2 (small logo) 15/3 (large logo)

A43-4.2		NZ Cycle Trail (NZCT) route arrow	
<i>Guides cyclists travelling along a road that forms an approved NZCT route by indicating directions to turn or confirming they are travelling in the correct direction.</i>			
Shape and size	rectangle 200 x 300 mm		
Background	white (R)		
Border	black 10 mm		
Legend	Description	Colour	Size
	“NZCT symbol” above	as for A43-4	140 x 126 mm
	“arrow” aligned appropriately	black	shaft 30 mm

A43-4.3		NZ Cycle Trail (NZCT) route information	
<i>Guides cyclists travelling along a road that forms an approved NZCT route by indicating directions to turn or confirming they are travelling in the correct direction.</i>			
Shape and size	rectangle 300 mm x height to fit message		
Background	white (R)		
Border	black 10 mm		
Legend	Description	Colour	Size

	“NZCT symbol” above	as for A43-4	200 x 180 mm
	“Word or words detailing the name of the route or the destination and may include the distance in km to that destination” above	black	25/5 upper case, 19/4.7 lower case
	“arrow” aligned appropriately	black	shaft 38 mm

A43-4.4 NZ Cycle Trail (NZCT) route begins/ends

Guides cyclists travelling along a road that forms an approved NZCT route by indicating the beginning or end of the NZCT route.

Shape and size rectangle 200 mm x height to fit message (small sign),
300 mm x height to fit message (large sign)

Background white (R)

Border black 10 mm

Legend	Description	Colour	Size
	“NZCT logo” above	as for A43-4.1	200 x 100 mm (small sign) 300 x 150 mm (large sign)
	optional - “Word or words detailing the name of the route”	black	25/5 upper case, 19/4.7 lower case
	“Cycle Trail”	black	25/5 upper case, 19/4.7 lower case
	“BEGINS” or “ENDS”	black	25/5

A45 Heavy-vehicle information

A45-1 Heavy vehicle bypass ahead ‘[distance]’ m

Indicates a heavy vehicle bypass ahead at a specified distance beyond the sign.

Shape and size rectangle 900 x 900 mm

Background white (R)

Border black 25 mm

Legend	Description	Colour	Size
	‘HEAVY’	black	120/19.2
	‘VEHICLE’	black	120/19.2
	‘BYPASS’	black	120/19.2

	'[distance] m'	black	numeral 120/19.2 'm' Tpt Med 'x' height 80 mm
--	----------------	-------	---

A45-2 Heavy vehicle bypass direction

Indicates the direction of a heavy traffic bypass at an intersection.

Shape and size rectangle 900 x 900 mm

Background White (R)

Border Black 25 mm

Legend	Description	Colour	Size
	'HEAVY'	black	120/19.2
	'VEHICLE'	black	120/19.2
	'BYPASS'	black	120/19.2
	'arrow (type A) pointing left or right'	black	600 mm long, shaft 55 mm

A45-3 Stock effluent dump site advisory

Advises drivers of vehicles transporting stock of a site beyond the sign where they may dispose of stock effluent.

Shape and size rectangle 1200 x 1200 mm

Background white (R)

Border black 40 mm

Legend	Description	Colour	Size
	'STOCK'	black	120/21.6
	'EFFLUENT'	black	120/21.6
	'DISPOSAL'	black	120/21.6
	'[distance] m'	black	numeral 120/21.6 'm' Tpt Med 'x' height 80 mm
	'ON LEFT' or 'ON RIGHT'	black	120/21.6

A45-3.1 Stock effluent dump site advance direction

Advises drivers of vehicles transporting stock the direction to turn at the stated distance ahead to reach a site where they may dispose of stock effluent.

Shape and size Rectangle 1200 x 1200 mm

Background White (R)

Border	Black 40 mm		
Legend	Description	Colour	Size
	“STOCK”	black	120/21.6
	“EFFLUENT”	black	120/21.6
	“DISPOSAL”	black	120/21.6
	“TURN LEFT” or “TURN RIGHT”	black	120/21.6
	“[distance] m”	black	numerals 120/21.6 “m” Tpt Med ‘x’ height 80 mm

A45-4	Stock effluent direction		
	<i>Indicates to drivers of vehicles transporting stock the location of a site where they may dispose of stock effluent.</i>		
Shape and size	rectangle 1200 x 1200 mm		
Background	white (R)		
Border	black 40 mm		
Legend	Description	Colour	Size
	‘STOCK’	black	120/21.6
	‘EFFLUENT’	black	120/21.6
	‘DISPOSAL’	black	120/21.6
	‘arrow (type D) pointing in the appropriate direction’	black	Shaft 110 mm

A45-5	Heavy vehicles please no engine braking next [distance] km		
	<i>Requests drivers of heavy vehicles not to use engine brakes to reduce noise through a township.</i>		
Shape and size	rectangle 1500 x 900 mm		
Background	white (R)		
Border	black 40 mm		
Legend	Description	Colour	Size
	‘HEAVY VEHICLES’	black	100/18
	‘PLEASE NO’	black	‘PLEASE’ 100/18 ‘NO’ 120/21.6
	‘ENGINE BRAKES’	black	100/18

‘NEXT [distance] km’	black	‘NEXT’ and numerals 120/21.6 ‘km’ Tpt Med ‘x’ height 60 mm
----------------------	-------	---

A45-6 Heavy vehicle bridge restriction ahead ‘[distance]’ km

Advises drivers of heavy vehicles of a bridge restriction ahead at a specified distance beyond the sign.

Shape and size Rectangle 900 × 750mm

Background White (R)

Border Black 25mm

Legend	Description	Colour	Size
	‘HEAVY VEHICLE’ above	black	100/13
	‘BRIDGE’ above	black	100/13
	‘RESTRICTION’ above	black	100/13
	‘[distance] km’	black	Text 75/12 ‘km’ Tpt Med ‘x’ height 50 mm

A50 General Advisory Information

A50-1 General advisory

Gives advisory information specific to the site not covered by any other sign in the A-series.

Shape and size rectangle at least 600 x 600 mm and sufficient to comfortably accommodate the legend

Background white (R)

Border black 25 mm

Legend	Description	Colour	Size
	‘[such words as are necessary to convey the advice to road users]’	black	100/14

A51-1 Cycle route advance direction – primary route

Advises cyclists the direction to follow at the intersection ahead to reach named destinations

Shape and size Rectangle at least 600 x 450 mm and large enough to accommodate the message, in two panels: top panel 140 mm high, lower panel at least 310 mm high.

Background	Top panel blue (R), lower panel white (R)		
Border	Blue (R) 20 mm		
Legend	Description	Colour	Size
Top panel	“cycle symbol” centralised in panel	White (R)	130 x 85 mm
	and optional symbol associated with the locality or the route	As for the symbol	100 x 100 mm maximum
Lower panel	Optional “[Route name]” (upper and lower case), above	White (R) text on a black background	Text: Tpt Med ‘x’ height 20 mm background: width to suit main legend x 60 mm high
	“[Primary route destination]” (upper and lower case), beside arrow (type D) aligned appropriately, above	Text: blue (R), arrow: blue (R)	Text: Tpt Med ‘x’ height 43 mm, arrow shaft: 27 mm
	a horizontal line, above	blue (R)	10 mm
	“[Alternate destination]” or “[Alternative destinations]” (upper and lower case), beside arrows (type D) aligned appropriately	Text: blue (R), arrows: blue (R)	Text: Tpt Med ‘x’ height 43 mm, arrow shaft: 27 mm

A51-2 Cycle route advance direction map – primary route

Advises cyclists the direction to follow at the intersection ahead to reach named destinations

Shape and size	Rectangle sized to suit the message, in two panels: top panel 140 mm high, lower panel sized to accommodate the map		
Background	Top panel blue (R), lower panel white (R)		
Border	Blue (R) 20 mm		
Legend	Description	Colour	Size
Top panel	“cycle symbol” centralised in panel	White (R)	130 x 85 mm
	and optional symbol associated with the locality or the route	As for the symbol	100 x 100 mm maximum

Lower panel	“[Graphical representation of the intersection ahead, showing details as necessary to explain the path of the cycle route and directions to alternative destinations.]” The map may include road names and destination names (upper and lower case) and directional arrows (type D).	Cycle route: Blue (R) destinations: blue (R) Arrows: blue (R) Road names: black Roads: grey other details: black	50 mm Tpt Med ‘x’ height 43 mm shaft width 27 mm Tpt Med ‘x’ height 21.5 mm 80 mm (main roads) 65 mm (other roads) as appropriate for the detail
--------------------	--	--	--

Cycle route intersection direction – primary route

A51-3

Advises cyclists the direction to follow at an intersection and the distances to named destinations

Shape and size Rectangle with pointed end (isosceles triangle, base the height of the rectangle, height approximately 40% of the base), length to suit message x 150 mm high (1 line of text) or 250 mm high (2 lines of text).

Background Blue (R) rectangle at least 160 mm wide x the height of the sign for the cycle symbol and optional symbol associated with the locality or route; white (R) for destination and chevron

Border Blue (R) 10 mm

Legend	Description	Colour	Size
	“Cycle symbol” (on blue background at square end of sign)	white (R)	130 x 85 mm
	and optional symbol associated with the locality or route (on blue background at square end of sign), beside	as for the symbol	100 x 100 mm maximum
	“[Destination]” or “[Destinations]” (upper and lower case, 1 or 2 lines of text), beside	Blue (R)	Tpt Med ‘x’ height 43 mm

“[distance] km” or “[distance] m”, beside	Blue (R)	Tpt Med ‘x’ height 43 mm
A chevron pointing in the direction of the destination, parallel to and located at the pointed end of the sign	Blue (R)	110 mm high, stripe width 45 mm (1 line of text), 210 mm high, stripe width 85 mm (2 lines of text)

A51-4 Cycle route intersection direction arrow – local route

Advises cyclists the direction to follow at an intersection and the distance to a named destination and the services available at the destination

Shape and size Rectangle length to suit the message x 200 mm high, in two panels: panel 1 at least 160 mm wide, panel 2 sized to accommodate the message

Background Panel 1 blue (R), panel 2 white (R)

Border Blue (R) 10 mm

Legend	Description	Colour	Size
---------------	--------------------	---------------	-------------

Panel 1 (closest to mounting post)	“Cycle symbol” and optional symbol associated with the locality or route, beside	white (R) as for the symbol	130 x 85 mm 100 x 100 mm maximum
--	---	------------------------------------	---

Panel 2, Option A 1 destination and service symbols

“[Destination]” (upper and lower case), above	Blue (R)	Tpt Med ‘x’ height 43 mm
---	----------	-----------------------------

Up to 6 “A20-S symbols” or “A30-S symbols or “A51-S symbols”, beside	White (R) symbol on blue (R) background	Each symbol, including a border, maximised to fit an area 45 x 45 mm
--	--	--

“[distance] km” or “[distance] m”, beside	Blue (R)	Tpt Med ‘x’ height 32 mm
---	----------	-----------------------------

Arrow (type D) aligned appropriately	Blue (R)	Shaft width 27 mm
--------------------------------------	----------	-------------------

Panel 2, Option B 2 destinations

“[Destination 1]” (upper and lower case), beside	Blue (R)	Tpt Med ‘x’ height 43 mm
“[distance] km” or “[distance} m”, above	Blue (R)	Tpt Med ‘x’ height 43 mm
“[Destination 2]” (upper and lower case), beside	Blue (R)	Tpt Med ‘x’ height 32 mm
“[distance] km” or “[distance] m”, beside		Tpt Med ‘x’ height 32 mm
Arrow (type D) aligned appropriately		Shaft width 27 mm

A51-5 Cycle route direction – primary route

Advises cyclists the direction to follow to reach named destinations

Shape and size Rectangle at least 600 x 300 mm and large enough to accommodate the message, in two panels: top panel 140 mm high, lower panel at least 160 mm high

Background Top panel blue (R), lower panel white (R)

Border Blue (R) 20 mm

Legend	Description	Colour	Size
Top panel	“cycle symbol” centralised in panel	White (R)	130 x 85 mm
	and optional symbol associated with the locality or the route	As for the symbol	100 x 100 mm maximum
Lower panel	“[Destination]” or “[Destinations]” (upper and lower case), beside arrows (type D) aligned appropriately	Text: blue (R) arrows: blue (R)	Text: Tpt Med ‘x’ height 43 mm, arrow shaft: 27 mm

3

A51-6 Cycle route marker – local route

Advises cyclists direction to follow to remain on a route

Option A	Vertical		
Shape and size	Rectangle 150 mm wide x at least 300 mm high, in two panels: top panel at least 150 mm high, lower panel 150 mm high		
Background	Top panel blue (R), lower panel white (R)		
Border	Blue (R) 10 mm		
Legend	Description	Colour	Size
Top panel	“cycle symbol”	White (R)	120 x 80 mm
	and optional symbol associated with the locality or the route	As for the symbol	100 x 100 mm maximum
Lower panel	Arrow (type D) aligned appropriately	Blue (R)	Shaft width 27 mm
Option B	Horizontal		
Shape and size	Rectangle 300 mm wide (at least) x 150 mm high, in two panels: panel 1 at least 150 mm wide, panel 2 150 mm wide		
Background	Panel 1 blue (R), panel 2 white (R)		
Border	Blue (R) 10 mm		
Legend	Description	Colour	Size
Panel 1 (closest to mounting post)	“cycle symbol”	White (R)	120 x 80 mm
	and optional symbol associated with the locality or the route	As for the symbol	100 x 100 mm maximum
Panel 2	Arrow (type D) aligned appropriately	Blue (R)	Shaft width 27 mm

A51-7	Cycle route location plate		
	<i>Advises cyclists the name of roads that cross a cycle route and are part of another cycle route</i>		
Shape and size	Rectangle length to suit road name x 150 mm high		
Background	Blue (R) rectangle at least 160 mm wide x 150 mm high for the cycle symbol and optional symbol associated with the locality or route; white (R) for the road name		
Border	Blue (R) 10 mm		
Legend	Description	Colour	Size
	“Cycle symbol”	white (R)	130 x 85 mm
	and optional symbol associated with the locality or route, to the left of	as for the symbol	100 x 100 mm maximum
	“[Name of road]” (upper and lower case)	Blue (R)	Tpt Med ‘x’ height 43 mm

A51-8	Cycle route confirmation direction – primary route		
	<i>Confirms the route that cyclists are on and advises the distances to the named destinations</i>		
Shape and size	Rectangle at least 600 x 300 mm and large enough to accommodate the message, in two panels: top panel 140 mm high, lower panel at least 160 mm high.		
Background	Top panel blue (R), lower panel white (R)		
Border	Blue (R) 20 mm		
Legend	Description	Colour	Size
Top panel	“cycle symbol” centralised in panel	White (R)	130 x 85 mm
	and optional symbol associated with the locality or the route	As for the symbol	100 x 100 mm maximum

Lower Panel	Optional “[Route name]” (upper and lower case), above	White (R) text on a black background	Text: Tpt Med ‘x’ height 20 mm background: width to suit main legend x 60 mm high
	“[Destination]” or “[Destinations]” (upper and lower case), beside	Blue (R)	Tpt Med ‘x’ height 43 mm
	“[distance] km” or “[distance] m”	Blue (R)	Tpt Med ‘x’ height 43 mm

A51-9 **Cycle route network map**

Advises cyclists of the cycle routes in the network

Shape and size Rectangle sized to suit the map, in two panels: top panel 150 mm high, lower panel sized to accommodate the map

Background Top panel blue (R), lower panel white (R)

Border Blue (R) 20 mm

Legend	Description	Colour	Size
Top panel	“cycle symbol” centralised in panel	White (R)	130 x 85 mm
	and optional symbol associated with the locality or the route	As for the symbol	100 x 100 mm maximum
Lower Panel	Optional “[Title of map]” (upper and lower case), above	black	Tpt Med ‘x’ height 20 mm
	“[Map]” (The map may include details as necessary to identify the routes shown and contact details for more information)	As for the map	As necessary

Schedule 1, opening words: amended, on 6 October 2006, by clause 4.1(1) of Land Transport Rule: Traffic Control Devices Amendment 2006.

Schedule 1, opening words: amended, on 17 January 2008, by clause 3.1(a) of Land Transport Rule: Traffic Control Devices Amendment 2007.

Schedule 1, opening words: amended, on 1 May 2021, by clause 2.4(1) and 2.4(2) of Land Transport Rule: Traffic Control Devices Amendment 2021.

As at 1 May 2021

Schedule 1, item relating to sign **R1-1.1**: amended, on 6 October 2006, by *clause 4.1(2)(a)* of *Land Transport Rule: Traffic Control Devices Amendment 2006*.

Schedule 1, item relating to sign **R1-1.2**: inserted, on 1 June 2019, by *clause 2.12(19)* of *Land Transport Rule: Traffic Control Devices Amendment 2019*.

Schedule 1, item relating to sign **R1-2.1**: replaced, on 1 November 2015, by *clause 3.1(1)* of *Land Transport Rule: Traffic Control Devices Amendment 2015*.

Schedule 1, item relating to sign **R1-2.1**: replaced, on 15 September 2005, by *clause 4.1* of *Land Transport Rule: Traffic Control Devices Amendment 2005*.

Schedule 1, item relating to sign **R1-2.1**: amended, on 6 October 2006, by *clause 4.1(2)(b)* of *Land Transport Rule: Traffic Control Devices Amendment 2006*.

Schedule 1, item relating to sign **R1-5.2**: amended, on 1 April 2011, by *clause 4.1(a)* of *Land Transport Rule: Traffic Control Devices Amendment 2010*.

Schedule 1, item relating to sign **R1-5.3**: inserted, on 1 April 2011, by *clause 4.1(b)* of *Land Transport Rule: Traffic Control Devices Amendment 2010*.

Schedule 1, item relating to sign **R1-5.4**: inserted, on 1 April 2011, by *clause 4.1(b)* of *Land Transport Rule: Traffic Control Devices Amendment 2010*.

Schedule 1, item relating to sign **R1-5.4**: amended, on 1 May 2021, by *clause 2.4(3)* of *Land Transport Rule: Traffic Control Devices Amendment 2021*.

Schedule 1, item relating to sign **R1-5.5**: inserted, on 1 January 2014, by *clause 4.1(1)* of *Land Transport Rule: Traffic Control Devices Amendment 2013*.

Schedule 1, item relating to sign **R1-5.6**: inserted, on 1 June 2019, by *clause 2.12(19)* of *Land Transport Rule: Traffic Control Devices Amendment 2019*.

Schedule 1, item relating to sign **R1-8**: amended, on 1 November 2014, by *clause 4.1(1)* of *Land Transport Rule: Traffic Control Devices Amendment 2014*.

Schedule 1, item relating to sign **R1-8**: amended, on 1 November 2014, by *clause 4.1(2)* of *Land Transport Rule: Traffic Control Devices Amendment 2014*.

Schedule 1, item relating to sign **R1-8.1**: amended, on 6 October 2006, by *clause 4.1(2)(c)* of *Land Transport Rule: Traffic Control Devices Amendment 2006*.

Schedule 1, item relating to sign **R1-8.2**: inserted, on 1 May 2021, by *clause 2.4(16)* of *Land Transport Rule: Traffic Control Devices Amendment 2021*.

Schedule 1, item relating to sign **R1-8.3**: inserted, on 1 May 2021, by *clause 2.4(16)* of *Land Transport Rule: Traffic Control Devices Amendment 2021*.

Schedule 1, item relating to sign **R2-1**: replaced, on 1 June 2019, by *clause 2.12(18)* of *Land Transport Rule: Traffic Control Devices Amendment 2019*.

Schedule 1, item relating to sign **R2-2.2**: amended, on 1 May 2021, by *clause 2.4(4)* of *Land Transport Rule: Traffic Control Devices Amendment 2021*.

Schedule 1, item relating to sign **R2-2.3**: amended, on 1 May 2021, by *clause 2.4(5)* of *Land Transport Rule: Traffic Control Devices Amendment 2021*.

Schedule 1, item relating to sign **R2-2.4**: inserted, on 1 January 2014, by *clause 4.1(1)* of *Land Transport Rule: Traffic Control Devices Amendment 2013*.

Schedule 1, item relating to sign **R2-2.4**: amended, on 1 May 2021, by *clause 2.4(6)* of *Land Transport Rule: Traffic Control Devices Amendment 2021*.

Schedule 1, item relating to sign **R2-2.5**: inserted, on 1 May 2021, by *clause 2.4(16) of Land Transport Rule: Traffic Control Devices Amendment 2021*.

Schedule 1, item relating to sign **R2-2.6**: inserted, on 1 May 2021, by *clause 2.4(16) of Land Transport Rule: Traffic Control Devices Amendment 2021*.

Schedule 1, item relating to sign **R2-3**: replaced, on 15 September 2005, by *clause 4.1 of Land Transport Rule: Traffic Control Devices Amendment 2005*.

Schedule 1, item relating to sign **R2-3**: replaced, on 1 April 2011, by *clause 4.1(c) of Land Transport Rule: Traffic Control Devices Amendment 2010*.

Schedule 1, item relating to sign **R2-3.1**: replaced, on 15 September 2005, by *clause 4.1 of Land Transport Rule: Traffic Control Devices Amendment 2005*.

Schedule 1, item relating to sign **R2-3.1**: amended, on 6 October 2006, by *clause 4.1(2)(d) of Land Transport Rule: Traffic Control Devices Amendment 2006*.

Schedule 1, item relating to sign **R2-4**: amended, on 1 April 2011, by *clause 4.1(a) of Land Transport Rule: Traffic Control Devices Amendment 2010*.

Schedule 1, item relating to sign **R2-6**: amended, on 17 January 2008, by *clause 3.1(d) of Land Transport Rule: Traffic Control Devices Amendment 2007*.

Schedule 1, item relating to sign **R2-6.2**: inserted, on 1 April 2011, by *clause 4.1(b) of Land Transport Rule: Traffic Control Devices Amendment 2010*.

Schedule 1, item relating to sign **R2-7**: replaced, on 1 April 2011, by *clause 4.1(c) of Land Transport Rule: Traffic Control Devices Amendment 2010*.

Schedule 1, item relating to sign **R2-7.1**: amended, on 17 January 2008, by *clause 3.1(d) of Land Transport Rule: Traffic Control Devices Amendment 2007*.

Schedule 1, item relating to sign **R2-8**: amended, on 17 January 2008, by *clause 3.1(d) of Land Transport Rule: Traffic Control Devices Amendment 2007*.

Schedule 1, item relating to sign **R2-9**: amended, on 17 January 2008, by *clause 3.1(d) of Land Transport Rule: Traffic Control Devices Amendment 2007*.

Schedule 1, item relating to sign **R2-9.1**: inserted, on 1 May 2021, by *clause 2.4(16) of Land Transport Rule: Traffic Control Devices Amendment 2021*.

Schedule 1, item relating to sign **R2-9.2**: inserted, on 1 May 2021, by *clause 2.4(16) of Land Transport Rule: Traffic Control Devices Amendment 2021*.

Schedule 1, item relating to sign **R2-10**: replaced, on 17 January 2008, by *clause 3.1(c)(i) of Land Transport Rule: Traffic Control Devices Amendment 2007*.

Schedule 1, item relating to sign **R2-11.3**: amended, on 6 October 2006, by *clause 4.1(2)(e) of Land Transport Rule: Traffic Control Devices Amendment 2006*.

Schedule 1, item relating to sign **R3-4**: amended, on 17 January 2008, by *clause 3.1(d) of Land Transport Rule: Traffic Control Devices Amendment 2007*.

Schedule 1, item relating to sign **R3-5.2**: inserted, on 1 May 2021, by *clause 2.4(16) of Land Transport Rule: Traffic Control Devices Amendment 2021*.

Schedule 1, item relating to sign **R3-5.4**: inserted, on 1 November 2015, by *clause 3.1(2) of Land Transport Rule: Traffic Control Devices Amendment 2015*.

Schedule 1, item relating to sign **R3-6**: amended, on 17 January 2008, by *clause 3.1(d) of Land Transport Rule: Traffic Control Devices Amendment 2007*.

Schedule 1, item relating to sign **R3-7.1**: inserted, on 1 April 2011, by *clause 4.1(b)* of *Land Transport Rule: Traffic Control Devices Amendment 2010*.

Schedule 1, item relating to sign **R3-13.3**: replaced, on 1 June 2019, by *clause 2.12(18)* of *Land Transport Rule: Traffic Control Devices Amendment 2019*.

Schedule 1, item relating to sign **R3-13.3**: amended, on 1 November 2015, by *clause 3.1(3)* of *Land Transport Rule: Traffic Control Devices Amendment 2015*.

Schedule 1, item relating to sign **R3-13.3**: inserted, on 1 April 2011, by *clause 4.1(b)* of *Land Transport Rule: Traffic Control Devices Amendment 2010*.

Schedule 1, item relating to sign **R4-7**: replaced, on 17 January 2008, by *clause 3.1(c)(i)* of *Land Transport Rule: Traffic Control Devices Amendment 2007*.

Schedule 1, item relating to sign **R4-7.1**: replaced, on 17 January 2008, by *clause 3.1(c)(i)* of *Land Transport Rule: Traffic Control Devices Amendment 2007*.

Schedule 1, item relating to sign **R4-7.2**: inserted, on 1 April 2011, by *clause 4.1(b)* of *Land Transport Rule: Traffic Control Devices Amendment 2010*.

Schedule 1, item relating to sign **R4-7.3**: inserted, on 1 April 2011, by *clause 4.1(b)* of *Land Transport Rule: Traffic Control Devices Amendment 2010*.

Schedule 1, item relating to sign **R4-8**: amended, on 1 April 2011, by *clause 4.1(a)* of *Land Transport Rule: Traffic Control Devices Amendment 2010*.

Schedule 1, item relating to sign **R4-8.1**: amended, on 1 April 2011, by *clause 4.1(a)* of *Land Transport Rule: Traffic Control Devices Amendment 2010*.

Schedule 1, item relating to sign **R4-8.2**: amended, on 1 April 2011, by *clause 4.1(a)* of *Land Transport Rule: Traffic Control Devices Amendment 2010*.

Schedule 1, item relating to sign **R4-8.3**: amended, on 1 April 2011, by *clause 4.1(a)* of *Land Transport Rule: Traffic Control Devices Amendment 2010*.

Schedule 1, item relating to sign **R4-8.5**: inserted, on 1 April 2011, by *clause 4.1(b)* of *Land Transport Rule: Traffic Control Devices Amendment 2010*.

Schedule 1, item relating to sign **R4-9**: replaced, on 17 January 2008, by *clause 3.1(c)(i)* of *Land Transport Rule: Traffic Control Devices Amendment 2007*.

Schedule 1, item relating to sign **R4-9.1**: amended, on 1 November 2014, by *clause 4.1(3)* of *Land Transport Rule: Traffic Control Devices Amendment 2014*.

Schedule 1, item relating to sign **R4-9.1**: replaced, on 17 January 2008, by *clause 3.1(c)(i)* of *Land Transport Rule: Traffic Control Devices Amendment 2007*.

Schedule 1, item relating to sign **R4-10**: inserted, on 1 April 2011, by *clause 4.1(b)* of *Land Transport Rule: Traffic Control Devices Amendment 2010*.

Schedule 1, item relating to sign **R4-11**: replaced, on 17 January 2008, by *clause 3.1(c)(i)* of *Land Transport Rule: Traffic Control Devices Amendment 2007*.

Schedule 1, item relating to sign **R4-12.2**: inserted, on 6 October 2006, by *clause 4.1(2)(f)* of *Land Transport Rule: Traffic Control Devices Amendment 2006*.

Schedule 1, item relating to sign **R4-12.2**: replaced, on 1 April 2011, by *clause 4.1(c)* of *Land Transport Rule: Traffic Control Devices Amendment 2010*.

Schedule 1, item relating to sign **R4-13**: amended, on 1 January 2014, by *clause 4.1(2)* of *Land Transport Rule: Traffic Control Devices Amendment 2013*.

Schedule 1, item relating to sign **R4-13**: inserted, on 1 April 2011, by *clause 4.1(b)* of *Land Transport Rule: Traffic Control Devices Amendment 2010*.

Schedule 1, item relating to sign **R4-13.1**: amended, on 1 January 2014, by *clause 4.1(3)* of *Land Transport Rule: Traffic Control Devices Amendment 2013*.

Schedule 1, item relating to sign **R4-13.1**: inserted, on 1 April 2011, by *clause 4.1(b)* of *Land Transport Rule: Traffic Control Devices Amendment 2010*.

Schedule 1, item relating to sign **R4-13.2**: inserted, on 1 June 2019, by *clause 2.12(19)* of *Land Transport Rule: Traffic Control Devices Amendment 2019*.

Schedule 1, item relating to sign **R4-13.3**: inserted, on 1 June 2019, by *clause 2.12(19)* of *Land Transport Rule: Traffic Control Devices Amendment 2019*.

Schedule 1, item relating to sign **R4-14**: inserted, on 1 June 2019, by *clause 2.12(19)* of *Land Transport Rule: Traffic Control Devices Amendment 2019*.

Schedule 1, item relating to sign **R4-14.1**: inserted, on 1 June 2019, by *clause 2.12(19)* of *Land Transport Rule: Traffic Control Devices Amendment 2019*.

Schedule 1, item relating to sign **R5-1**: amended, on 17 January 2008, by *clause 3.1(d)* of *Land Transport Rule: Traffic Control Devices Amendment 2007*.

Schedule 1, item relating to sign **R5-2**: amended, on 17 January 2008, by *clause 3.1(d)* of *Land Transport Rule: Traffic Control Devices Amendment 2007*.

Schedule 1, item relating to sign **R5-3**: amended, on 17 January 2008, by *clause 3.1(d)* of *Land Transport Rule: Traffic Control Devices Amendment 2007*.

Schedule 1, item relating to sign **R5-6**: replaced, on 17 January 2008, by *clause 3.1(c)(i)* of *Land Transport Rule: Traffic Control Devices Amendment 2007*.

Schedule 1, item relating to sign **R5-9**: replaced, on 1 June 2019, by *clause 2.12(18)* of *Land Transport Rule: Traffic Control Devices Amendment 2019*.

Schedule 1, item relating to sign **R5-9**: replaced, on 1 April 2011, by *clause 4.1(c)* of *Land Transport Rule: Traffic Control Devices Amendment 2010*.

Schedule 1, item relating to sign **R5-9**: amended, on 1 May 2021, by *clause 2.4(7)* of *Land Transport Rule: Traffic Control Devices Amendment 2021*.

Schedule 1, item relating to sign **R5-9.1**: amended, on 1 April 2011, by *clause 4.1(a)* of *Land Transport Rule: Traffic Control Devices Amendment 2010*.

Schedule 1, item relating to sign **R5-9.1**: amended, on 1 May 2021, by *clause 2.4(16)* of *Land Transport Rule: Traffic Control Devices Amendment 2021*.

Schedule 1, item relating to sign **R5-9.2**: inserted, on 1 May 2021, by *clause 2.4(16)* of *Land Transport Rule: Traffic Control Devices Amendment 2021*.

Schedule 1, item relating to sign **R5-9.3**: inserted, on 1 May 2021, by *clause 2.4(16)* of *Land Transport Rule: Traffic Control Devices Amendment 2021*.

Schedule 1, item relating to sign **R5-9.4**: inserted, on 1 May 2021, by *clause 2.4(16)* of *Land Transport Rule: Traffic Control Devices Amendment 2021*.

Schedule 1, item relating to sign **R5-11**: inserted, on 1 April 2011, by *clause 4.1(b)* of *Land Transport Rule: Traffic Control Devices Amendment 2010*.

Schedule 1, item relating to sign **R5-12**: inserted, on 1 April 2011, by *clause 4.1(b)* of *Land Transport Rule: Traffic Control Devices Amendment 2010*.

Schedule 1, item relating to sign **R5-13**: inserted, on 1 April 2011, by *clause 4.1(b) of Land Transport Rule: Traffic Control Devices Amendment 2010*.

Schedule 1, item relating to sign **R5-13.1**: inserted, on 1 April 2011, by *clause 4.1(b) of Land Transport Rule: Traffic Control Devices Amendment 2010*.

Schedule 1, item relating to sign **R5-13.2**: inserted, on 1 April 2011, by *clause 4.1(b) of Land Transport Rule: Traffic Control Devices Amendment 2010*.

Schedule 1, items relating to *Parking sign – components*: inserted, on 1 April 2011, by *clause 4.1(e) of Land Transport Rule: Traffic Control Devices Amendment 2010*.

Schedule 1, items in the series **R6-1** (being items **R6-1A**, **R6-1B**, **R6-1C**, **R6-1C.1**, **R6-1C.2**, **R6-1T**, **R6-1T.1**, **R6-1T.2**, **R6-1T.3**, **R6-1T.4**, **R6-1D**, **R6-1D.1**): inserted, on 1 April 2011, by *clause 4.1(e) of Land Transport Rule: Traffic Control Devices Amendment 2010*.

Schedule 1, item relating to series **R6-2B**: replaced, on 1 June 2019, by *clause 2.12(18) of Land Transport Rule: Traffic Control Devices Amendment 2019*.

Schedule 1, items in the series **R6-2B**: revoked, on 1 October 2017, by *Part 5 of Schedule 3 of Land Transport Amendment Act 2017*.

Schedule 1, items in the series **R6-2B**: amended, on 1 October 2017, by *Part 5 of Schedule 3 of Land Transport Amendment Act 2017*.

Schedule 1, item in the series **R6-2C**: amended, on 1 October 2017, by *Part 5 of Schedule 3 of Land Transport Amendment Act 2017*.

Schedule 1, item in the series **R6-2C**: inserted, on 1 September 2017, by *clause 7(1) of Land Transport Rule: Traffic Control Devices Amendment 2017*.

Schedule 1, item relating to series **R6-2C**: amended, on 1 January 2014, by *clause 4.1(4) of Land Transport Rule: Traffic Control Devices Amendment 2013*.

Schedule 1, item in the series **R6-2S**: revoked, on 1 October 2017, by *Part 5 of Schedule 3 of Land Transport Amendment Act 2017*.

Schedule 1, item in the series **R6-2S**: inserted, on 1 September 2017, by *clause 7(2) of Land Transport Rule: Traffic Control Devices Amendment 2017*.

Schedule 1, items in the series **R6-2** (being item **R6-2A**, items in the series **R6-2B**, items in the series **R6-2C**, and items in the series **R6-2S**): inserted, on 1 April 2011, by *clause 4.1(e) of Land Transport Rule: Traffic Control Devices Amendment 2010*.

Schedule 1, item in the series **R6-3**: amended, on 1 June 2019, by *clause 2.12(20) of Land Transport Rule: Traffic Control Devices Amendment 2019*.

Schedule 1, item relating to series **R6-3**: amended, on 1 January 2014, by *clause 4.1(5) of Land Transport Rule: Traffic Control Devices Amendment 2013*.

Schedule 1, items in the series **R6-3**: inserted, on 1 April 2011, by *clause 4.1(e) of Land Transport Rule: Traffic Control Devices Amendment 2010*.

Schedule 1, item in the series **R6-4**: amended, on 1 June 2019, by *clause 2.12(21) of Land Transport Rule: Traffic Control Devices Amendment 2019*.

Schedule 1, items in the series **R6-4**: amended, on 1 January 2014, by *clause 4.1(6) of Land Transport Rule: Traffic Control Devices Amendment 2013*.

Schedule 1, items in the series **R6-4**: inserted, on 1 April 2011, by *clause 4.1(e) of Land Transport Rule: Traffic Control Devices Amendment 2010*.

Schedule 1, item relating to sign **R6-5.1**: inserted, on 1 June 2019, by *clause 2.12(19)* of *Land Transport Rule: Traffic Control Devices Amendment 2019*.

Schedule 1, items relating to signs **R6-10, R6-10.1, R6-10.2, R6-10.3, R6-11, R6-11.1, R6-12.1, R6-12.2, R6-12.3, R6-12.4, R6-12.5, R6-30, R6-30.1, R6-31, R6-32, R6-50, R6-50.1, R6-50.2, R6-51, R6-51.1, R6-52, R6-52.1, R6-53, R6-53.1, R6-53.2, R6-53.3, R6-54, R6-54.1, R6-54.2, R6-55, R6-56, R6-57, R6-58, R6-59, R6-69, R6-70, R6-70.1, R6-71, R6-71.1, R6-71.2, R6-72, R6-72.1, R6-73, R6-73.1, R6-74, R6-74.1, R6-79**: revoked, on 1 April 2011, by *clause 4.1(e)* of *Land Transport Rule: Traffic Control Devices Amendment 2010*.

Schedule 1, item relating to sign **R7-1A**: inserted, on 1 April 2011, by *clause 4.1(b)* of *Land Transport Rule: Traffic Control Devices Amendment 2010*.

Schedule 1, item relating to sign **R7-2.1**: inserted, on 1 April 2011, by *clause 4.1(b)* of *Land Transport Rule: Traffic Control Devices Amendment 2010*.

Schedule 1, item relating to sign **R7-2.2**: inserted, on 1 April 2011, by *clause 4.1(b)* of *Land Transport Rule: Traffic Control Devices Amendment 2010*.

Schedule 1, item relating to sign **R7-2.3**: inserted, on 1 April 2011, by *clause 4.1(b)* of *Land Transport Rule: Traffic Control Devices Amendment 2010*.

Schedule 1, items relating to signs **W1-1.1, W1-1.2, W1-1.3, W1-1.4, W1-1.5, W1-1.6, W1-1.7, W1-1.8, W1-1.9, W1-1.11, W1-1.12, W1-1.13**: replaced, on 1 June 2019, by *clause 2.12(18)* of *Land Transport Rule: Traffic Control Devices Amendment 2019*.

Schedule 1, item relating to sign **W1-1.1**: amended, on 1 April 2011, by *clause 4.1(a)* of *Land Transport Rule: Traffic Control Devices Amendment 2010*.

Schedule 1, item relating to sign **W1-1.2**: amended, on 1 April 2011, by *clause 4.1(a)* of *Land Transport Rule: Traffic Control Devices Amendment 2010*.

Schedule 1, item relating to sign **W1-1.3**: amended, on 1 April 2011, by *clause 4.1(a)* of *Land Transport Rule: Traffic Control Devices Amendment 2010*.

Schedule 1, item relating to sign **W1-1.4**: amended, on 1 April 2011, by *clause 4.1(a)* of *Land Transport Rule: Traffic Control Devices Amendment 2010*.

Schedule 1, item relating to sign **W1-1.5**: amended, on 1 April 2011, by *clause 4.1(a)* of *Land Transport Rule: Traffic Control Devices Amendment 2010*.

Schedule 1, item relating to sign **W1-1.6**: amended, on 1 April 2011, by *clause 4.1(a)* of *Land Transport Rule: Traffic Control Devices Amendment 2010*.

Schedule 1, item relating to sign **W1-1.7**: amended, on 1 April 2011, by *clause 4.1(a)* of *Land Transport Rule: Traffic Control Devices Amendment 2010*.

Schedule 1, item relating to sign **W1-1.8**: amended, on 1 April 2011, by *clause 4.1(a)* of *Land Transport Rule: Traffic Control Devices Amendment 2010*.

Schedule 1, item relating to sign **W1-1.9**: amended, on 1 April 2011, by *clause 4.1(a)* of *Land Transport Rule: Traffic Control Devices Amendment 2010*.

Schedule 1, item relating to sign **W1-1.10**: amended, on 1 April 2011, by *clause 4.1(a)* of *Land Transport Rule: Traffic Control Devices Amendment 2010*.

Schedule 1, item relating to sign **W1-1.10**: inserted, on 6 October 2006, by *clause 4.1(2)(f)* of *Land Transport Rule: Traffic Control Devices Amendment 2006*.

Schedule 1, item relating to sign **W1-1.11**: inserted, on 1 April 2011, by *clause 4.1(b)* of *Land Transport Rule: Traffic Control Devices Amendment 2010*.

Schedule 1, item relating to sign **W1-1.12**: inserted, on 1 April 2011, by *clause 4.1(b)* of *Land Transport Rule: Traffic Control Devices Amendment 2010*.

Schedule 1, item relating to sign **W1-1.13**: inserted, on 1 April 2011, by *clause 4.1(b)* of *Land Transport Rule: Traffic Control Devices Amendment 2010*.

Schedule 1, item relating to sign **W1-2**: replaced, on 1 June 2019, by *clause 2.12(18)* of *Land Transport Rule: Traffic Control Devices Amendment 2019*.

Schedule 1, item relating to sign **W1-2**: amended, on 17 January 2008, by *clause 3.1(d)* of *Land Transport Rule: Traffic Control Devices Amendment 2007*.

Schedule 1, item relating to sign **W1-2B**: replaced, on 1 June 2019, by *clause 2.12(18)* of *Land Transport Rule: Traffic Control Devices Amendment 2019*.

Schedule 1, item relating to sign **W1-3**: replaced, on 1 June 2019, by *clause 2.12(18)* of *Land Transport Rule: Traffic Control Devices Amendment 2019*.

Schedule 1, item relating to sign **W1-4**: replaced, on 1 June 2019, by *clause 2.12(18)* of *Land Transport Rule: Traffic Control Devices Amendment 2019*.

Schedule 1, items relating to signs **W2-1.1, W2-1.2, W2-1.3, W2-1.4, W2-1.5, W2-1.6, W2-1.7, W2-1.8, W2-1.9, W2-1.10, W2-1.11, W2-1.12, W2-1.13, W2-1.14, W2-1.15, W2-1.16, W2-1.17, W2-1.18, W2-1.19, W2-1.20, W2-1.21, W2-1.22, W2-1.23, W2-1.24**: replaced, on 1 June 2019, by *clause 2.12(18)* of *Land Transport Rule: Traffic Control Devices Amendment 2019*.

I, item relating to sign **W2-1**: amended, on 1 April 2011, by *clause 4.1(a)* of *Land Transport Rule: Traffic Control Devices Amendment 2010*.

Schedule 1, item relating to sign **W2-1.1**: amended, on 1 April 2011, by *clause 4.1(a)* of *Land Transport Rule: Traffic Control Devices Amendment 2010*.

Schedule 1, item relating to sign **W2-1.2**: amended, on 1 April 2011, by *clause 4.1(a)* of *Land Transport Rule: Traffic Control Devices Amendment 2010*.

Schedule 1, item relating to sign **W2-1.25**: inserted, on 1 May 2021, by *clause 2.4(16)* of *Land Transport Rule: Traffic Control Devices Amendment 2021*.

Schedule 1, item relating to sign **W2-1.26**: inserted, on 1 May 2021, by *clause 2.4(16)* of *Land Transport Rule: Traffic Control Devices Amendment 2021*.

Schedule 1, item relating to sign **W2-1.3**: amended, on 1 April 2011, by *clause 4.1(a)* of *Land Transport Rule: Traffic Control Devices Amendment 2010*.

Schedule 1, item relating to sign **W2-1.3**: replaced, on 1 May 2021, by *clause 2.4(8)* of *Land Transport Rule: Traffic Control Devices Amendment 2021*.

Schedule 1, item relating to sign **W2-1.4**: amended, on 1 April 2011, by *clause 4.1(a)* of *Land Transport Rule: Traffic Control Devices Amendment 2010*.

Schedule 1, item relating to sign **W2-1.5**: amended, on 1 April 2011, by *clause 4.1(a)* of *Land Transport Rule: Traffic Control Devices Amendment 2010*.

Schedule 1, item relating to sign **W2-1.6**: amended, on 1 April 2011, by *clause 4.1(a)* of *Land Transport Rule: Traffic Control Devices Amendment 2010*.

Schedule 1, item relating to sign **W2-1.7**: amended, on 1 April 2011, by *clause 4.1(a)* of *Land Transport Rule: Traffic Control Devices Amendment 2010*.

Schedule 1, item relating to sign **W2-1.8**: amended, on 1 April 2011, by *clause 4.1(a)* of *Land Transport Rule: Traffic Control Devices Amendment 2010*.

Schedule 1, item relating to sign **W2-1.9**: amended, on 1 April 2011, by *clause 4.1(a)* of *Land Transport Rule: Traffic Control Devices Amendment 2010*.

Schedule 1, item relating to sign **W2-1.10**: amended, on 1 April 2011, by *clause 4.1(a)* of *Land Transport Rule: Traffic Control Devices Amendment 2010*.

Schedule 1, item relating to sign **W2-1.11**: amended, on 1 April 2011, by *clause 4.1(a)* of *Land Transport Rule: Traffic Control Devices Amendment 2010*.

Schedule 1, item relating to sign **W2-1.12**: amended, on 1 April 2011, by *clause 4.1(a)* of *Land Transport Rule: Traffic Control Devices Amendment 2010*.

Schedule 1, item relating to sign **W2-1.13**: amended, on 1 April 2011, by *clause 4.1(a)* of *Land Transport Rule: Traffic Control Devices Amendment 2010*.

Schedule 1, item relating to sign **W2-1.13**: replaced, on 1 May 2021, by *clause 2.4(8)* of *Land Transport Rule: Traffic Control Devices Amendment 2021*.

Schedule 1, item relating to sign **W2-1.14**: amended, on 1 April 2011, by *clause 4.1(a)* of *Land Transport Rule: Traffic Control Devices Amendment 2010*.

Schedule 1, item relating to sign **W2-1.15**: amended, on 1 April 2011, by *clause 4.1(a)* of *Land Transport Rule: Traffic Control Devices Amendment 2010*.

Schedule 1, item relating to sign **W2-1.16**: amended, on 1 April 2011, by *clause 4.1(a)* of *Land Transport Rule: Traffic Control Devices Amendment 2010*.

Schedule 1, item relating to sign **W2-1.17**: amended, on 1 April 2011, by *clause 4.1(a)* of *Land Transport Rule: Traffic Control Devices Amendment 2010*.

Schedule 1, item relating to sign **W2-1.18**: amended, on 1 April 2011, by *clause 4.1(a)* of *Land Transport Rule: Traffic Control Devices Amendment 2010*.

Schedule 1, item relating to sign **W2-1.19**: amended, on 1 April 2011, by *clause 4.1(a)* of *Land Transport Rule: Traffic Control Devices Amendment 2010*.

Schedule 1, item relating to sign **W2-1.20**: amended, on 1 April 2011, by *clause 4.1(a)* of *Land Transport Rule: Traffic Control Devices Amendment 2010*.

Schedule 1, item relating to sign **W2-1.21**: amended, on 1 April 2011, by *clause 4.1(a)* of *Land Transport Rule: Traffic Control Devices Amendment 2010*.

Schedule 1, item relating to sign **W2-1.22**: amended, on 1 April 2011, by *clause 4.1(a)* of *Land Transport Rule: Traffic Control Devices Amendment 2010*.

Schedule 1, item relating to sign **W2-1.22**: inserted, on 6 October 2006, by *clause 4.1(2)(f)* of *Land Transport Rule: Traffic Control Devices Amendment 2006*.

Schedule 1, item relating to sign **W2-1.23**: inserted, on 1 April 2011, by *clause 4.1(b)* of *Land Transport Rule: Traffic Control Devices Amendment 2010*.

Schedule 1, item relating to sign **W2-1.24**: inserted, on 1 November 2015, by *clause 3.1(4)* of *Land Transport Rule: Traffic Control Devices Amendment 2015*.

Schedule 1, item relating to sign **W3-2.1**: amended, on 1 January 2014, by *clause 4.1(7)* of *Land Transport Rule: Traffic Control Devices Amendment 2013*.

Schedule 1, item relating to sign **W3-2.2**: inserted, on 1 June 2019, by *clause 2.12(19)* of *Land Transport Rule: Traffic Control Devices Amendment 2019*.

Schedule 1, item relating to sign **W3-3.1**: amended, on 1 April 2011, by *clause 4.1(a)* of *Land Transport Rule: Traffic Control Devices Amendment 2010*.

Schedule 1, item relating to sign **W3-3.2**: amended, on 1 April 2011, by *clause 4.1(a)* of *Land Transport Rule: Traffic Control Devices Amendment 2010*.

Schedule 1, item relating to sign **W3-5**: amended, on 17 January 2008, by *clause 3.1(d)* of *Land Transport Rule: Traffic Control Devices Amendment 2007*.

Schedule 1, item relating to sign **W3-6**: amended, on 17 January 2008, by *clause 3.1(d)* of *Land Transport Rule: Traffic Control Devices Amendment 2007*.

Schedule 1, item relating to sign **W3-6.1**: amended, on 17 January 2008, by *clause 3.1(d)* of *Land Transport Rule: Traffic Control Devices Amendment 2007*.

Schedule 1, item relating to sign **W3-6.1**: amended, on 1 April 2011, by *clause 4.1(a)* of *Land Transport Rule: Traffic Control Devices Amendment 2010*.

Schedule 1, item relating to sign **W3-7**: amended, on 17 January 2008, by *clause 3.1(d)* of *Land Transport Rule: Traffic Control Devices Amendment 2007*.

Schedule 1, item relating to sign **W3-8**: amended, on 17 January 2008, by *clause 3.1(d)* of *Land Transport Rule: Traffic Control Devices Amendment 2007*.

Schedule 1, item relating to sign **W3-9**: inserted, on 6 October 2006, by *clause 4.1(2)(f)* of *Land Transport Rule: Traffic Control Devices Amendment 2006*.

Schedule 1, item relating to sign **W3-9**: amended, on 17 January 2008, by *clause 3.1(d)* of *Land Transport Rule: Traffic Control Devices Amendment 2007*.

Schedule 1, item relating to sign **W4-1.1**: amended, on 17 January 2008, by *clause 3.1(d)* of *Land Transport Rule: Traffic Control Devices Amendment 2007*.

Schedule 1, item relating to sign **W4-1.2**: amended, on 17 January 2008, by *clause 3.1(d)* of *Land Transport Rule: Traffic Control Devices Amendment 2007*.

Schedule 1, item relating to sign **W4-1.3**: amended, on 17 January 2008, by *clause 3.1(d)* of *Land Transport Rule: Traffic Control Devices Amendment 2007*.

Schedule 1, item relating to sign **W4-1.4**: inserted, on 6 October 2006, by *clause 4.1(2)(f)* of *Land Transport Rule: Traffic Control Devices Amendment 2006*.

Schedule 1, item relating to sign **W4-1.4**: amended, on 17 January 2008, by *clause 3.1(d)* of *Land Transport Rule: Traffic Control Devices Amendment 2007*.

Schedule 1, item relating to sign **W4-2.1**: amended, on 17 January 2008, by *clause 3.1(d)* of *Land Transport Rule: Traffic Control Devices Amendment 2007*.

Schedule 1, item relating to sign **W4-2.2**: amended, on 17 January 2008, by *clause 3.1(d)* of *Land Transport Rule: Traffic Control Devices Amendment 2007*.

Schedule 1, item relating to sign **W4-3**: amended, on 17 January 2008, by *clause 3.1(d)* of *Land Transport Rule: Traffic Control Devices Amendment 2007*.

Schedule 1, item relating to sign **W4-4**: amended, on 17 January 2008, by *clause 3.1(d)* of *Land Transport Rule: Traffic Control Devices Amendment 2007*.

Schedule 1, item relating to sign **W4-5**: amended, on 17 January 2008, by *clause 3.1(d)* of *Land Transport Rule: Traffic Control Devices Amendment 2007*.

Schedule 1, item relating to sign **W4-6**: amended, on 17 January 2008, by *clause 3.1(d)* of *Land Transport Rule: Traffic Control Devices Amendment 2007*.

Schedule 1, item relating to sign **W4-7**: amended, on 17 January 2008, by *clause 3.1(d)* of *Land Transport Rule: Traffic Control Devices Amendment 2007*.

Schedule 1, item relating to sign W4-7.1: amended, on 17 January 2008, by clause 3.1(d) of Land Transport Rule: Traffic Control Devices Amendment 2007.

Schedule 1, item relating to sign W4-7.1: amended, on 1 April 2011, by clause 4.1(a) of Land Transport Rule: Traffic Control Devices Amendment 2010.

Schedule 1, item relating to sign W4-8: amended, on 17 January 2008, by clause 3.1(d) of Land Transport Rule: Traffic Control Devices Amendment 2007.

Schedule 1, item relating to sign W4-10: amended, on 17 January 2008, by clause 3.1(d) of Land Transport Rule: Traffic Control Devices Amendment 2007.

Schedule 1, item relating to sign W4-11: inserted, on 1 April 2011, by clause 4.1(b) of Land Transport Rule: Traffic Control Devices Amendment 2010.

Schedule 1, item relating to sign W5-1: amended, on 17 January 2008, by clause 3.1(d) of Land Transport Rule: Traffic Control Devices Amendment 2007.

Schedule 1, item relating to sign W5-1.1: inserted, on 1 April 2011, by clause 4.1(b) of Land Transport Rule: Traffic Control Devices Amendment 2010.

Schedule 1, item relating to sign W5-2: amended, on 17 January 2008, by clause 3.1(d) of Land Transport Rule: Traffic Control Devices Amendment 2007.

Schedule 1, item relating to sign W5-2.21: amended, on 17 January 2008, by clause 3.1(d) of Land Transport Rule: Traffic Control Devices Amendment 2007.

Schedule 1, item relating to sign W5-2.21: amended, on 1 April 2011, by clause 4.1(a) of Land Transport Rule: Traffic Control Devices Amendment 2010.

Schedule 1, item relating to sign W5-2.22: amended, on 17 January 2008, by clause 3.1(d) of Land Transport Rule: Traffic Control Devices Amendment 2007.

Schedule 1, item relating to sign W5-2.22: amended, on 1 April 2011, by clause 4.1(a) of Land Transport Rule: Traffic Control Devices Amendment 2010.

Schedule 1, item relating to sign W5-2.23: amended, on 17 January 2008, by clause 3.1(d) of Land Transport Rule: Traffic Control Devices Amendment 2007.

Schedule 1, item relating to sign W5-2.23: amended, on 1 April 2011, by clause 4.1(a) of Land Transport Rule: Traffic Control Devices Amendment 2010.

Schedule 1, item relating to sign W5-3: amended, on 17 January 2008, by clause 3.1(d) of Land Transport Rule: Traffic Control Devices Amendment 2007.

Schedule 1, item relating to sign W5-3.1: amended, on 17 January 2008, by clause 3.1(d) of Land Transport Rule: Traffic Control Devices Amendment 2007.

Schedule 1, item relating to sign W5-3.1: amended, on 1 April 2011, by clause 4.1(a) of Land Transport Rule: Traffic Control Devices Amendment 2010.

Schedule 1, item relating to sign W5-4: amended, on 17 January 2008, by clause 3.1(d) of Land Transport Rule: Traffic Control Devices Amendment 2007.

Schedule 1, item relating to sign W5-4: amended, on 1 April 2011, by clause 4.1(a) of Land Transport Rule: Traffic Control Devices Amendment 2010.

Schedule 1, item relating to sign W5-5: amended, on 17 January 2008, by clause 3.1(d) of Land Transport Rule: Traffic Control Devices Amendment 2007.

Schedule 1, item relating to sign W5-5: amended, on 1 April 2011, by clause 4.1(a) of Land Transport Rule: Traffic Control Devices Amendment 2010.

Schedule 1, item relating to sign **W5-6**: amended, on 17 January 2008, by *clause 3.1(d)* of *Land Transport Rule: Traffic Control Devices Amendment 2007*.

Schedule 1, item relating to sign **W5-6**: amended, on 1 April 2011, by *clause 4.1(a)* of *Land Transport Rule: Traffic Control Devices Amendment 2010*.

Schedule 1, item relating to sign **W5-7.11**: amended, on 17 January 2008, by *clause 3.1(d)* of *Land Transport Rule: Traffic Control Devices Amendment 2007*.

Schedule 1, item relating to sign **W5-7.11**: amended, on 1 April 2011, by *clause 4.1(a)* of *Land Transport Rule: Traffic Control Devices Amendment 2010*.

Schedule 1, item relating to sign **W5-7.12**: amended, on 17 January 2008, by *clause 3.1(d)* of *Land Transport Rule: Traffic Control Devices Amendment 2007*.

Schedule 1, item relating to sign **W5-7.12**: amended, on 1 April 2011, by *clause 4.1(a)* of *Land Transport Rule: Traffic Control Devices Amendment 2010*.

Schedule 1, item relating to sign **W5-7.13**: amended, on 17 January 2008, by *clause 3.1(d)* of *Land Transport Rule: Traffic Control Devices Amendment 2007*.

Schedule 1, item relating to sign **W5-7.13**: amended, on 1 April 2011, by *clause 4.1(a)* of *Land Transport Rule: Traffic Control Devices Amendment 2010*.

Schedule 1, item relating to sign **W5-8.11**: amended, on 17 January 2008, by *clause 3.1(d)* of *Land Transport Rule: Traffic Control Devices Amendment 2007*.

Schedule 1, item relating to sign **W5-8.11**: amended, on 1 April 2011, by *clause 4.1(a)* of *Land Transport Rule: Traffic Control Devices Amendment 2010*.

Schedule 1, item relating to sign **W5-8.12**: amended, on 17 January 2008, by *clause 3.1(d)* of *Land Transport Rule: Traffic Control Devices Amendment 2007*.

Schedule 1, item relating to sign **W5-8.12**: amended, on 1 April 2011, by *clause 4.1(a)* of *Land Transport Rule: Traffic Control Devices Amendment 2010*.

Schedule 1, item relating to sign **W5-8.13**: amended, on 17 January 2008, by *clause 3.1(d)* of *Land Transport Rule: Traffic Control Devices Amendment 2007*.

Schedule 1, item relating to sign **W5-8.13**: amended, on 1 April 2011, by *clause 4.1(a)* of *Land Transport Rule: Traffic Control Devices Amendment 2010*.

Schedule 1, item relating to sign **W6-1**: amended, on 17 January 2008, by *clause 3.1(d)* of *Land Transport Rule: Traffic Control Devices Amendment 2007*.

Schedule 1, item relating to sign **W6-2**: amended, on 17 January 2008, by *clause 3.1(d)* of *Land Transport Rule: Traffic Control Devices Amendment 2007*.

Schedule 1, item relating to sign **W6-3**: amended, on 17 January 2008, by *clause 3.1(d)* of *Land Transport Rule: Traffic Control Devices Amendment 2007*.

Schedule 1, item relating to sign **W6-5**: inserted, on 1 November 2015, by *clause 3.1(5)* of *Land Transport Rule: Traffic Control Devices Amendment 2015*.

Schedule 1, item relating to sign **W6-5**: amended, on 1 May 2021, by *clause 2.4(9)* of *Land Transport Rule: Traffic Control Devices Amendment 2021*.

Schedule 1, item relating to sign **W6-6**: inserted, on 1 November 2015, by *clause 3.1(5)* of *Land Transport Rule: Traffic Control Devices Amendment 2015*.

Schedule 1, item relating to sign **W6-7**: inserted, on 1 May 2021, by *clause 2.4(16)* of *Land Transport Rule: Traffic Control Devices Amendment 2021*.

Schedule 1, item relating to sign **W6-8**: inserted, on 1 May 2021, by *clause 2.4(16)* of *Land Transport Rule: Traffic Control Devices Amendment 2021*.

Schedule 1, item relating to sign **W6-9**: inserted, on 1 May 2021, by *clause 2.4(16)* of *Land Transport Rule: Traffic Control Devices Amendment 2021*.

Schedule 1, item relating to sign **W6-10**: inserted, on 1 May 2021, by *clause 2.4(16)* of *Land Transport Rule: Traffic Control Devices Amendment 2021*.

Schedule 1, item relating to sign **W6-11**: inserted, on 1 May 2021, by *clause 2.4(16)* of *Land Transport Rule: Traffic Control Devices Amendment 2021*.

Schedule 1, item relating to sign **W7-1**: amended, on 17 January 2008, by *clause 3.1(d)* of *Land Transport Rule: Traffic Control Devices Amendment 2007*.

Schedule 1, item relating to sign **W7-1**: amended, on 1 April 2011, by *clause 4.1(a)* of *Land Transport Rule: Traffic Control Devices Amendment 2010*.

Schedule 1, item relating to sign **W7-1**: amended, on 1 May 2021, by *clause 2.4(10)* of *Land Transport Rule: Traffic Control Devices Amendment 2021*.

Schedule 1, item relating to sign **W7-2**: amended, on 1 April 2011, by *clause 4.1(a)* of *Land Transport Rule: Traffic Control Devices Amendment 2010*.

Schedule 1, item relating to sign **W7-2**: amended, on 1 May 2021, by *clause 2.4(11)* of *Land Transport Rule: Traffic Control Devices Amendment 2021*.

Schedule 1, item relating to sign **W7-3**: amended, on 1 April 2011, by *clause 4.1(a)* of *Land Transport Rule: Traffic Control Devices Amendment 2010*.

Schedule 1, item relating to sign **W7-3**: amended, on 1 May 2021, by *clause 2.4(12)* of *Land Transport Rule: Traffic Control Devices Amendment 2021*.

Schedule 1, item relating to sign **W7-4**: amended, on 1 April 2011, by *clause 4.1(a)* of *Land Transport Rule: Traffic Control Devices Amendment 2010*.

Schedule 1, item relating to sign **W7-4**: amended, on 1 May 2021, by *clause 2.4(13)* of *Land Transport Rule: Traffic Control Devices Amendment 2021*.

Schedule 1, item relating to sign **W7-5**: amended, on 17 January 2008, by *clause 3.1(d)* of *Land Transport Rule: Traffic Control Devices Amendment 2007*.

Schedule 1, item relating to sign **W7-5.1**: amended, on 17 January 2008, by *clause 3.1(d)* of *Land Transport Rule: Traffic Control Devices Amendment 2007*.

Schedule 1, item relating to sign **W7-6**: amended, on 17 January 2008, by *clause 3.1(d)* of *Land Transport Rule: Traffic Control Devices Amendment 2007*.

Schedule 1, item relating to sign **W7-6**: amended, on 1 April 2011, by *clause 4.1(a)* of *Land Transport Rule: Traffic Control Devices Amendment 2010*.

Schedule 1, item relating to sign **W7-6**: amended, on 1 May 2021, by *clause 2.4(14)* of *Land Transport Rule: Traffic Control Devices Amendment 2021*.

Schedule 1, item relating to sign **W7-7**: amended, on 17 January 2008, by *clause 3.1(d)* of *Land Transport Rule: Traffic Control Devices Amendment 2007*.

Schedule 1, item relating to sign **W7-7**: amended, on 1 April 2011, by *clause 4.1(a)* of *Land Transport Rule: Traffic Control Devices Amendment 2010*.

Schedule 1, item relating to sign **W7-7.1**: inserted, on 1 April 2011, by *clause 4.1(b)* of *Land Transport Rule: Traffic Control Devices Amendment 2010*.

As at 1 May 2021

Schedule 1, item relating to sign **W7-7.1**: amended, on 1 May 2021, by *clause 2.4(15) of Land Transport Rule: Traffic Control Devices Amendment 2021*.

Schedule 1, item relating to sign **W7-8**: amended, on 17 January 2008, by *clause 3.1(d) of Land Transport Rule: Traffic Control Devices Amendment 2007*.

Schedule 1, item relating to sign **W10-2**: amended, on 1 November 2015, by *clause 3.1(6) of Land Transport Rule: Traffic Control Devices Amendment 2015*.

Schedule 1, item relating to sign **W10-3**: replaced, on 1 June 2019, by *clause 2.12(18) of Land Transport Rule: Traffic Control Devices Amendment 2019*.

Schedule 1, item relating to sign **W10-4.1**: revoked, on 1 April 2011, by *clause 4.1(d) of Land Transport Rule: Traffic Control Devices Amendment 2010*.

Schedule 1, item relating to sign **W10-4.2**: revoked, on 1 April 2011, by *clause 4.1(d) of Land Transport Rule: Traffic Control Devices Amendment 2010*.

Schedule 1, item relating to sign **W10-6.1**: replaced, on 17 January 2008, by *clause 3.1(c)(ii) of Land Transport Rule: Traffic Control Devices Amendment 2007*.

Schedule 1, item relating to sign **W10-6.2**: replaced, on 17 January 2008, by *clause 3.1(c)(ii) of Land Transport Rule: Traffic Control Devices Amendment 2007*.

Schedule 1, item relating to sign **W10-6.3**: replaced, on 17 January 2008, by *clause 3.1(c)(ii) of Land Transport Rule: Traffic Control Devices Amendment 2007*.

Schedule 1, item relating to sign **W13-1.3**: inserted, on 1 April 2011, by *clause 4.1(b) of Land Transport Rule: Traffic Control Devices Amendment 2010*.

Schedule 1, item relating to sign **W13-1.4**: inserted, on 1 April 2011, by *clause 4.1(b) of Land Transport Rule: Traffic Control Devices Amendment 2010*.

Schedule 1, item relating to sign **W14-7.1**: replaced, on 1 June 2019, by *clause 2.12(18) of Land Transport Rule: Traffic Control Devices Amendment 2019*.

Schedule 1, item relating to sign **W14-7.2**: replaced, on 1 June 2019, by *clause 2.12(18) of Land Transport Rule: Traffic Control Devices Amendment 2019*.

Schedule 1, item relating to sign **W14-7.4**: inserted, on 1 April 2011, by *clause 4.1(b) of Land Transport Rule: Traffic Control Devices Amendment 2010*.

Schedule 1, item relating to sign **W14-9.3**: revoked, on 1 April 2011, by *clause 4.1(d) of Land Transport Rule: Traffic Control Devices Amendment 2010*.

Schedule 1, item relating to sign **W14-11**: inserted, on 1 December 2016, by *clause 2.4 of Land Transport Rule: Traffic Control Devices Amendment 2016*.

Schedule 1, item relating to sign **W14-11.1**: inserted, on 1 December 2016, by *clause 2.4 of Land Transport Rule: Traffic Control Devices Amendment 2016*.

Schedule 1, item relating to sign **W14-12**: inserted, on 1 December 2016, by *clause 2.4 of Land Transport Rule: Traffic Control Devices Amendment 2016*.

Schedule 1, item relating to sign **W15-1**: replaced, on 1 April 2011, by *clause 4.1(c) of Land Transport Rule: Traffic Control Devices Amendment 2010*.

Schedule 1, item relating to sign **W15-1.1**: replaced, on 1 April 2011, by *clause 4.1(c) of Land Transport Rule: Traffic Control Devices Amendment 2010*.

Schedule 1, item relating to sign **W15-2**: replaced, on 1 April 2011, by *clause 4.1(c) of Land Transport Rule: Traffic Control Devices Amendment 2010*.

Schedule 1, item relating to sign **W15-3.1A**: inserted, on 1 April 2011, by *clause 4.1(b)* of *Land Transport Rule: Traffic Control Devices Amendment 2010*.

Schedule 1, item relating to sign **W15-3.1B**: inserted, on 1 April 2011, by *clause 4.1(b)* of *Land Transport Rule: Traffic Control Devices Amendment 2010*.

Schedule 1, item relating to sign **W15-3.2**: inserted, on 1 April 2011, by *clause 4.1(b)* of *Land Transport Rule: Traffic Control Devices Amendment 2010*.

Schedule 1, item relating to sign **W15-3.2A**: inserted, on 1 April 2011, by *clause 4.1(b)* of *Land Transport Rule: Traffic Control Devices Amendment 2010*.

Schedule 1, item relating to sign **W15-7**: amended, on 17 January 2008, by *clause 3.1(d)* of *Land Transport Rule: Traffic Control Devices Amendment 2007*.

Schedule 1, item relating to sign **W15-8.4**: inserted, on 1 April 2011, by *clause 4.1(b)* of *Land Transport Rule: Traffic Control Devices Amendment 2010*.

Schedule 1, item relating to sign **W15-8.5**: inserted, on 1 April 2011, by *clause 4.1(b)* of *Land Transport Rule: Traffic Control Devices Amendment 2010*.

Schedule 1, item relating to sign **W16-7.1**: inserted, on 1 June 2019, by *clause 2.12(19)* of *Land Transport Rule: Traffic Control Devices Amendment 2019*.

Schedule 1, item relating to sign **W16-9**: inserted, on 1 November 2014, by *clause 4.1(4)* of *Land Transport Rule: Traffic Control Devices Amendment 2014*.

Schedule 1, item relating to sign **W16-9.1**: inserted, on 1 November 2014, by *clause 4.1(4)* of *Land Transport Rule: Traffic Control Devices Amendment 2014*.

Schedule 1, item relating to sign **W16-10**: inserted, on 1 May 2021, by *clause 2.4(16)* of *Land Transport Rule: Traffic Control Devices Amendment 2021*.

Schedule 1, item relating to sign **W17-1.3**: amended, on 1 October 2011, by *clause 2.1(a)* of *Land Transport Rule: Traffic Control Devices Amendment 2011*.

Schedule 1, item relating to sign **W17-1.3**: replaced, on 17 January 2008, by *clause 3.1(c)(ii)* of *Land Transport Rule: Traffic Control Devices Amendment 2007*.

Schedule 1, item relating to sign **W17-1.4**: inserted, on 17 January 2008, by *clause 3.1(b)* of *Land Transport Rule: Traffic Control Devices Amendment 2007*.

Schedule 1, item relating to sign **W17-6**: replaced, on 1 June 2019, by *clause 2.12(18)* of *Land Transport Rule: Traffic Control Devices Amendment 2019*.

Schedule 1, item relating to sign **W17-7**: inserted, on 1 April 2011, by *clause 4.1(b)* of *Land Transport Rule: Traffic Control Devices Amendment 2010*.

Schedule 1, item relating to sign **W7-7.1**: inserted, on 1 April 2011, by *clause 4.1(b)* of *Land Transport Rule: Traffic Control Devices Amendment 2010*.

Schedule 1, item relating to sign **W18-2.1**: inserted, on 6 October 2006, by *clause 4.1(2)(f)* of *Land Transport Rule: Traffic Control Devices Amendment 2006*.

Schedule 1, item relating to sign **W18-3.3**: inserted, on 1 April 2011, by *clause 4.1(b)* of *Land Transport Rule: Traffic Control Devices Amendment 2010*.

Schedule 1, item relating to sign **W18-3.4**: inserted, on 1 April 2011, by *clause 4.1(b)* of *Land Transport Rule: Traffic Control Devices Amendment 2010*.

Schedule 1, item relating to sign **W18-3.5**: inserted, on 1 April 2011, by *clause 4.1(b)* of *Land Transport Rule: Traffic Control Devices Amendment 2010*.

Schedule 1, item relating to sign **W18-3.6**: inserted, on 1 April 2011, by *clause 4.1(b)* of *Land Transport Rule: Traffic Control Devices Amendment 2010*.

Schedule 1, item relating to sign **W18-3.7**: inserted, on 1 April 2011, by *clause 4.1(b)* of *Land Transport Rule: Traffic Control Devices Amendment 2010*.

Schedule 1, item relating to sign **W18-3.8**: inserted, on 1 April 2011, by *clause 4.1(b)* of *Land Transport Rule: Traffic Control Devices Amendment 2010*.

Schedule 1, item relating to sign **W18-3.9**: inserted, on 1 April 2011, by *clause 4.1(b)* of *Land Transport Rule: Traffic Control Devices Amendment 2010*.

Schedule 1, item relating to sign **W18-3.10**: inserted, on 1 June 2019, by *clause 2.12(19)* of *Land Transport Rule: Traffic Control Devices Amendment 2019*.

Schedule 1, item relating to sign **W18-3.12**: inserted, on 1 May 2021, by *clause 2.4(16)* of *Land Transport Rule: Traffic Control Devices Amendment 2021*.

Schedule 1, heading above item relating to sign **W19-1**: inserted, on 1 October 2011, by *clause 2.1(b)* of *Land Transport Rule: Traffic Control Devices Amendment 2011*.

Schedule 1, item relating to sign **W19-1**: inserted, on 1 April 2011, by *clause 4.1(b)* of *Land Transport Rule: Traffic Control Devices Amendment 2010*.

Schedule 1, item relating to sign **W19-1.1**: inserted, on 1 April 2011, by *clause 4.1(b)* of *Land Transport Rule: Traffic Control Devices Amendment 2010*.

Schedule 1, item relating to sign **W19-2.1**: inserted, on 1 April 2011, by *clause 4.1(b)* of *Land Transport Rule: Traffic Control Devices Amendment 2010*.

Schedule 1, item relating to sign **W19-2.1**: amended, on 1 November 2015, by *clause 3.1(7)* of *Land Transport Rule: Traffic Control Devices Amendment 2015*.

Schedule 1, item relating to sign **W19-2.1**: amended, on 1 November 2015, by *clause 3.1(8)* of *Land Transport Rule: Traffic Control Devices Amendment 2015*.

Schedule 1, item relating to sign **W19-2.2**: inserted, on 1 April 2011, by *clause 4.1(b)* of *Land Transport Rule: Traffic Control Devices Amendment 2010*.

Schedule 1, item relating to sign **W20-1.3**: inserted, on 1 April 2011, by *clause 4.1(b)* of *Land Transport Rule: Traffic Control Devices Amendment 2010*.

Schedule 1, item relating to sign **W20-1.4**: inserted, on 1 April 2011, by *clause 4.1(b)* of *Land Transport Rule: Traffic Control Devices Amendment 2010*.

Schedule 1, item relating to sign **W20-3.1A**: inserted, on 1 April 2011, by *clause 4.1(b)* of *Land Transport Rule: Traffic Control Devices Amendment 2010*.

Schedule 1, item relating to sign **W20-3.2A**: inserted, on 1 April 2011, by *clause 4.1(b)* of *Land Transport Rule: Traffic Control Devices Amendment 2010*.

Schedule 1, item relating to sign **W20-3.3A**: inserted, on 1 April 2011, by *clause 4.1(b)* of *Land Transport Rule: Traffic Control Devices Amendment 2010*.

Schedule 1, item relating to sign **A11-6**: inserted, on 1 April 2011, by *clause 4.1(b)* of *Land Transport Rule: Traffic Control Devices Amendment 2010*.

Schedule 1, item relating to sign **A12-3**: amended, on 1 April 2011, by *clause 4.1(a)* of *Land Transport Rule: Traffic Control Devices Amendment 2010*.

Schedule 1, item relating to sign **A13-1**: amended, on 1 April 2011, by *clause 4.1(a)* of *Land Transport Rule: Traffic Control Devices Amendment 2010*.

Schedule 1, item relating to sign **A13-1.1**: amended, on 1 April 2011, by *clause 4.1(a)* of *Land Transport Rule: Traffic Control Devices Amendment 2010*.

Schedule 1, item relating to sign **A13-1.2**: replaced, on 1 April 2011, by *clause 4.1(c)* of *Land Transport Rule: Traffic Control Devices Amendment 2010*.

Schedule 1, item relating to sign **A13-2**: amended, on 1 April 2011, by *clause 4.1(a)* of *Land Transport Rule: Traffic Control Devices Amendment 2010*.

Schedule 1, item relating to sign **A13-3**: amended, on 1 April 2011, by *clause 4.1(a)* of *Land Transport Rule: Traffic Control Devices Amendment 2010*.

Schedule 1, item relating to sign **A13-3.2**: replaced, on 1 April 2011, by *clause 4.1(c)* of *Land Transport Rule: Traffic Control Devices Amendment 2010*.

Schedule 1, item relating to sign **A14-1**: amended, on 1 November 2014, by *clause 4.1(5)* of *Land Transport Rule: Traffic Control Devices Amendment 2014*.

Schedule 1, item relating to sign **A14-1**: amended, on 1 November 2014, by *clause 4.1(6)* of *Land Transport Rule: Traffic Control Devices Amendment 2014*.

Schedule 1, item relating to sign **A20-S22**: inserted, on 1 September 2017, by *clause 7(3)* of *Land Transport Rule: Traffic Control Devices Amendment 2017*.

Schedule 1, item relating to sign **A21-5**: inserted, on 1 April 2011, by *clause 4.1(b)* of *Land Transport Rule: Traffic Control Devices Amendment 2010*.

Schedule 1, item relating to sign **A22-1**: amended, on 1 April 2011, by *clause 4.1(a)* of *Land Transport Rule: Traffic Control Devices Amendment 2010*.

Schedule 1, item relating to sign **A22-2**: amended, on 1 April 2011, by *clause 4.1(a)* of *Land Transport Rule: Traffic Control Devices Amendment 2010*.

Schedule 1, item relating to sign **A22-3**: amended, on 1 April 2011, by *clause 4.1(a)* of *Land Transport Rule: Traffic Control Devices Amendment 2010*.

Schedule 1, items relating to sign **A30-S** (being **A-30-S1**, **A-30-S2**, **A-30-S3**, **A-30-S4**): inserted, on 1 June 2019, by *clause 2.12(19)* of *Land Transport Rule: Traffic Control Devices Amendment 2019*.

Schedule 1, item relating to sign **A31-1**: replaced, on 1 June 2019, by *clause 2.12(18)* of *Land Transport Rule: Traffic Control Devices Amendment 2019*.

Schedule 1, item relating to sign **A31-3**: inserted, on 1 June 2019, by *clause 2.12(19)* of *Land Transport Rule: Traffic Control Devices Amendment 2019*.

Schedule 1, item relating to sign **A31-5**: inserted, on 1 June 2019, by *clause 2.12(19)* of *Land Transport Rule: Traffic Control Devices Amendment 2019*.

Schedule 1, item relating to sign **A32-1**: replaced, on 1 June 2019, by *clause 2.12(18)* of *Land Transport Rule: Traffic Control Devices Amendment 2019*.

Schedule 1, item relating to sign **A32-1**: amended, on 1 April 2011, by *clause 4.1(a)* of *Land Transport Rule: Traffic Control Devices Amendment 2010*.

Schedule 1, item relating to sign **A32-2**: replaced, on 1 June 2019, by *clause 2.12(18)* of *Land Transport Rule: Traffic Control Devices Amendment 2019*.

Schedule 1, item relating to sign **A32-2**: amended, on 1 April 2011, by *clause 4.1(a)* of *Land Transport Rule: Traffic Control Devices Amendment 2010*.

Schedule 1, item relating to sign **A32-3**: inserted, on 1 June 2019, by *clause 2.12(19)* of *Land Transport Rule: Traffic Control Devices Amendment 2019*.

Schedule 1, item relating to sign A40-1: amended, on 1 January 2014, by clause 4.1(8) of Land Transport Rule: Traffic Control Devices Amendment 2013.

Schedule 1, item relating to sign A40-3: amended, on 1 January 2014, by clause 4.1(8) of Land Transport Rule: Traffic Control Devices Amendment 2013.

Schedule 1, item relating to sign A40-6: inserted, on 1 April 2011, by clause 4.1(b) of Land Transport Rule: Traffic Control Devices Amendment 2010.

Schedule 1, item relating to sign A40-7: inserted, on 1 November 2012, by clause 2.1 of Land Transport Rule: Traffic Control Devices Amendment 2012.

Schedule 1, item relating to sign A42-2: replaced, on 1 June 2019, by clause 2.12(18) of Land Transport Rule: Traffic Control Devices Amendment 2019.

Schedule 1, item relating to sign A42-3: amended, on 1 January 2014, by clause 4.1(9) of Land Transport Rule: Traffic Control Devices Amendment 2013.

Schedule 1, item relating to sign A42-4: amended, on 1 January 2014, by clause 4.1(10) of Land Transport Rule: Traffic Control Devices Amendment 2013.

Schedule 1, item relating to sign A42-5: amended, on 1 January 2014, by clause 4.1(10) of Land Transport Rule: Traffic Control Devices Amendment 2013.

Schedule 1, item relating to sign A42-6: inserted, on 1 June 2019, by clause 2.12(19) of Land Transport Rule: Traffic Control Devices Amendment 2019.

Schedule 1, item relating to sign A42-6.1: inserted, on 1 June 2019, by clause 2.12(19) of Land Transport Rule: Traffic Control Devices Amendment 2019.

Schedule 1, item relating to sign A42-6.2: inserted, on 1 June 2019, by clause 2.12(19) of Land Transport Rule: Traffic Control Devices Amendment 2019.

Schedule 1, item relating to sign A42-6.3: inserted, on 1 June 2019, by clause 2.12(19) of Land Transport Rule: Traffic Control Devices Amendment 2019.

Schedule 1, item relating to sign A43-4: inserted, on 1 January 2014, by clause 4.1(1) of Land Transport Rule: Traffic Control Devices Amendment 2013.

Schedule 1, item relating to sign A43-4.1: inserted, on 1 January 2014, by clause 4.1(1) of Land Transport Rule: Traffic Control Devices Amendment 2013.

Schedule 1, item relating to sign A43-4.2: inserted, on 1 January 2014, by clause 4.1(1) of Land Transport Rule: Traffic Control Devices Amendment 2013.

Schedule 1, item relating to sign A43-4.3: inserted, on 1 January 2014, by clause 4.1(1) of Land Transport Rule: Traffic Control Devices Amendment 2013.

Schedule 1, item relating to sign A43-4.4: inserted, on 1 January 2014, by clause 4.1(1) of Land Transport Rule: Traffic Control Devices Amendment 2013.

Schedule 1, item relating to sign A43-5: inserted, on 1 June 2019, by clause 2.12(19) of Land Transport Rule: Traffic Control Devices Amendment 2019.

Schedule 1, item relating to sign A43-6: inserted, on 1 June 2019, by clause 2.12(19) of Land Transport Rule: Traffic Control Devices Amendment 2019.

Schedule 1, item relating to sign A43-7: inserted, on 1 May 2021, by clause 2.4(16) of Land Transport Rule: Traffic Control Devices Amendment 2021.

Schedule 1, item relating to sign A43-8: inserted, on 1 May 2021, by clause 2.4(16) of Land Transport Rule: Traffic Control Devices Amendment 2021.

Schedule 1, item relating to sign **A45-1**: replaced, on 1 June 2019, by *clause 2.12(18)* of *Land Transport Rule: Traffic Control Devices Amendment 2019*.

Schedule 1, item relating to sign **A45-2**: replaced, on 1 June 2019, by *clause 2.12(18)* of *Land Transport Rule: Traffic Control Devices Amendment 2019*.

Schedule 1, item relating to sign **A45-3**: replaced, on 1 June 2019, by *clause 2.12(18)* of *Land Transport Rule: Traffic Control Devices Amendment 2019*.

Schedule 1, item relating to sign **A45-3.1**: inserted, on 1 June 2019, by *clause 2.12(19)* of *Land Transport Rule: Traffic Control Devices Amendment 2019*.

Schedule 1, item relating to sign **A45-4**: replaced, on 1 June 2019, by *clause 2.12(18)* of *Land Transport Rule: Traffic Control Devices Amendment 2019*.

Schedule 1, item relating to sign **A45-5**: replaced, on 1 June 2019, by *clause 2.12(18)* of *Land Transport Rule: Traffic Control Devices Amendment 2019*.

Schedule 1, item relating to sign **A45-6**: inserted, on 1 May 2021, by *clause 2.4(16)* of *Land Transport Rule: Traffic Control Devices Amendment 2021*.

Schedule 1, item relating to sign **A50**: inserted, on 17 January 2008, by *clause 3.1(b)* of *Land Transport Rule: Traffic Control Devices Amendment 2007*.

Schedule 1, items relating to signs **A51-1**, **A51-2**, **A51-3**, **A51-4**, **A51-5**, **A51-6**, **A51-7**, **A51-8**, **A51-9**: inserted, on 1 June 2019, by *clause 2.12(19)* of *Land Transport Rule: Traffic Control Devices Amendment 2019*.

Schedule 2 Markings

- All measurements are shown in millimetres, unless otherwise indicated.

M1-1 Pedestrian crossing

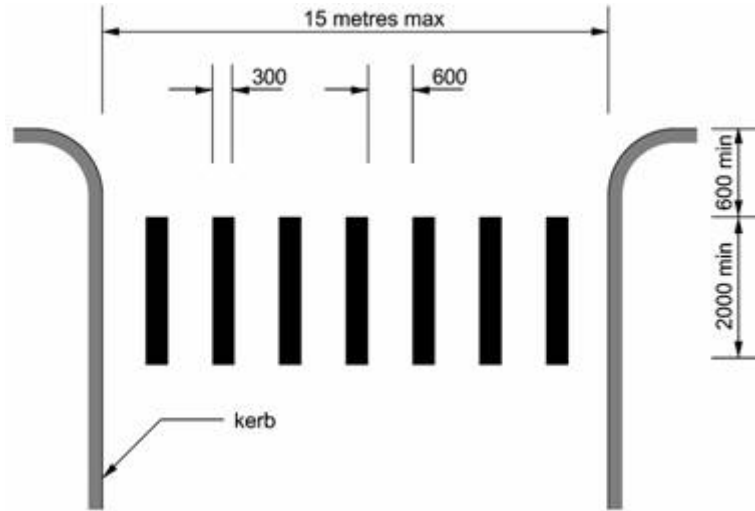

M1-2 Diamond advance warning symbol

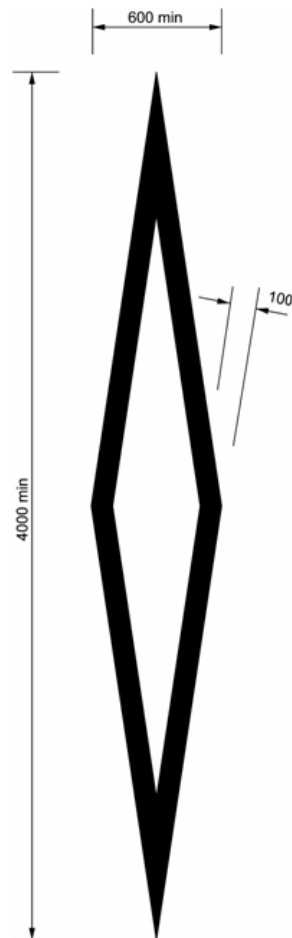

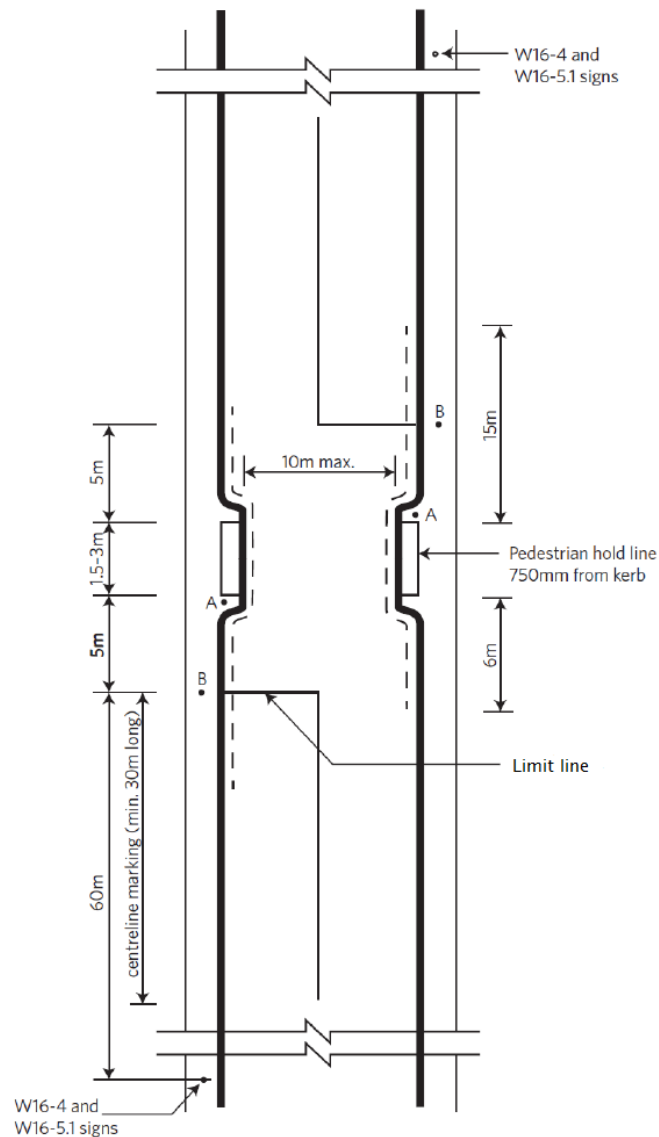
M1-3 School crossing point

Unless otherwise stated all dimensions are minimum

Key

- A Support R2-4 school patrol sign (within 300 mm of crossing point definition lines and kerb face or edge of road).
- B Support and W16-4.1 children flag within 300 mm of kerb face and end of vehicle hold line. The W16-4.1 children flag on each approach should be mounted so it is clearly visible to approaching drivers from at least 60 m, but does not obscure the school patrol's view of approaching traffic.

Note: The length of the no stopping restriction on the approach side may be reduced to a minimum of 6 m where bulbous kerbs, at least 1.8 m wide, or inset parking are provided to ensure adequate visibility. On the departure side, the length of the no stopping restriction must be a minimum of 6 m.

Schedule 2, diagram **M1-3**: amended, on 6 October 2006, by clause 4.2(a) of Land Transport Rule: Traffic Control Devices Amendment 2006.

As at 1 May 2021

M1-4 Placement of warning lights – not to scale

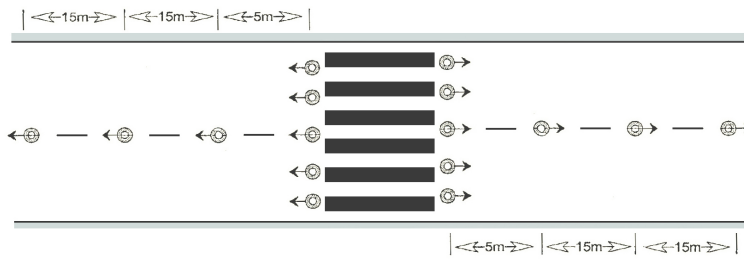

Two-lane, undivided roadway

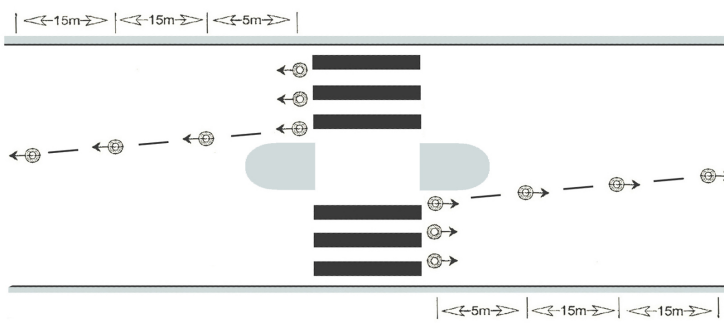

Two-lane, undivided roadway with pedestrian island

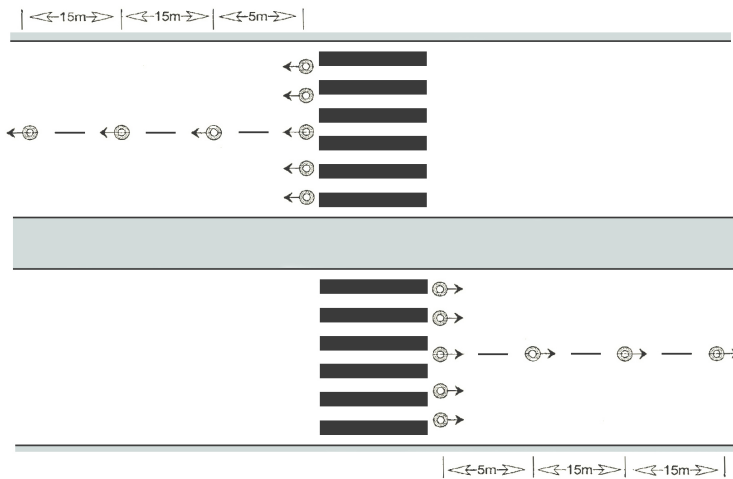

Divided roadway

Note: the warning lights installed parallel to the marked pedestrian crossing are located on, or in advance of and immediately adjacent to, the pedestrian crossing limit line.

M2-1 Transit lane – T2

Letter heights: 2400 mm (urban), 3600 mm (rural)



M2-1.1 Transit lane – T3

Letter heights: 2400 mm (urban), 3600 mm (rural)



M2-2 Bus lane

Letter heights: 2400 mm (urban), 3600 mm (rural)

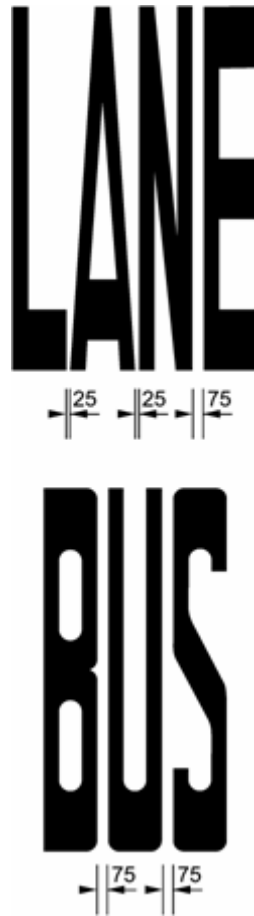

M2-2.1 Bus only

Letter heights: 2400 mm (urban), 3600 mm (rural)

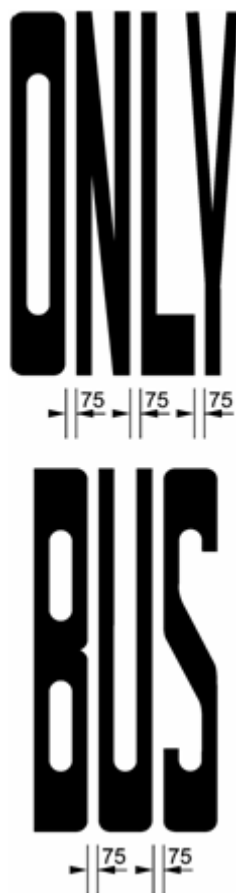

M2-3

Symbol for cycle lanes, cycle paths and shared paths

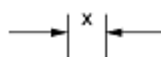
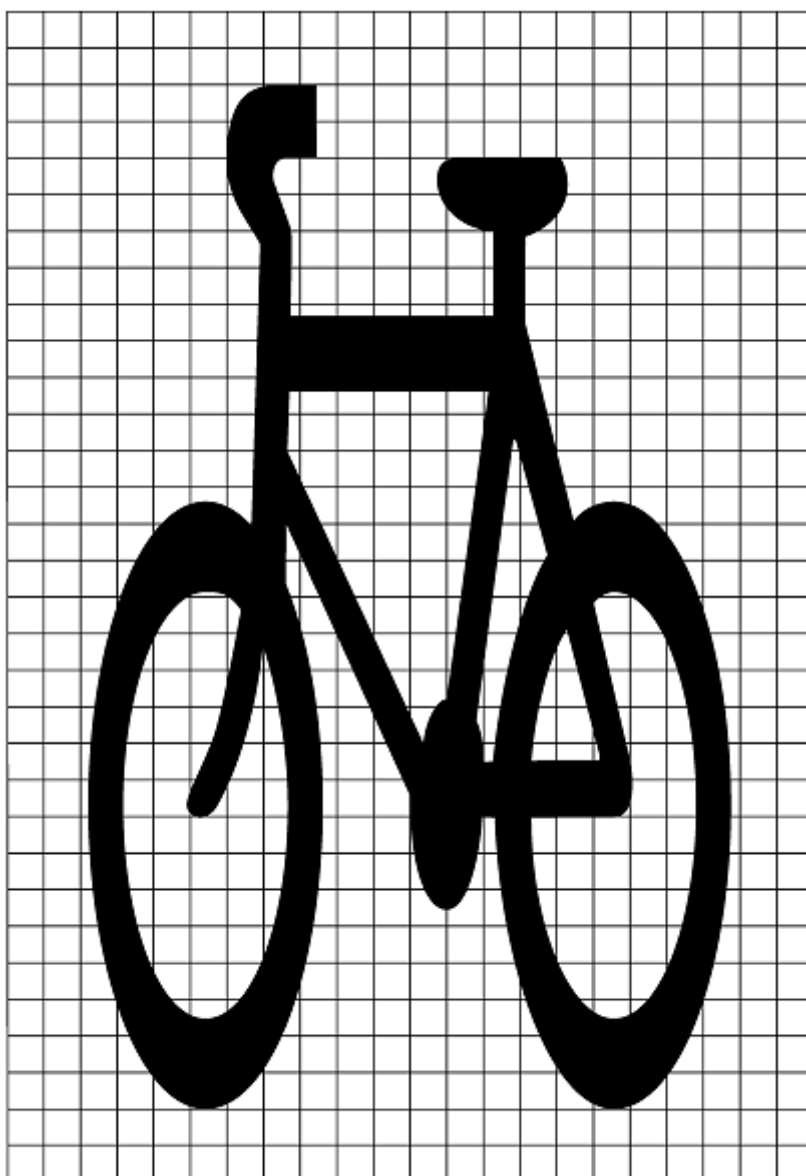

x, dimension of square grid, 20 mm minimum

M2-3A Cycle lane (pre-2004 form)

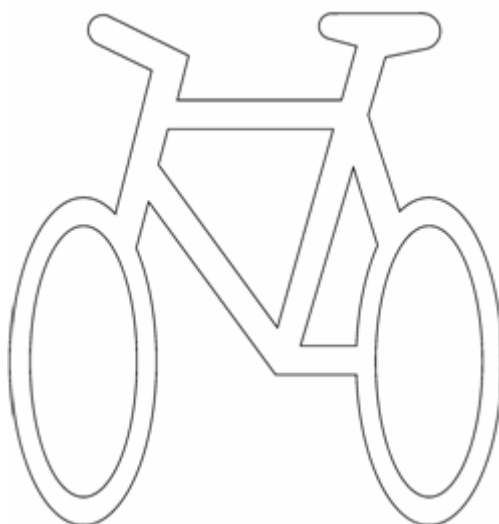
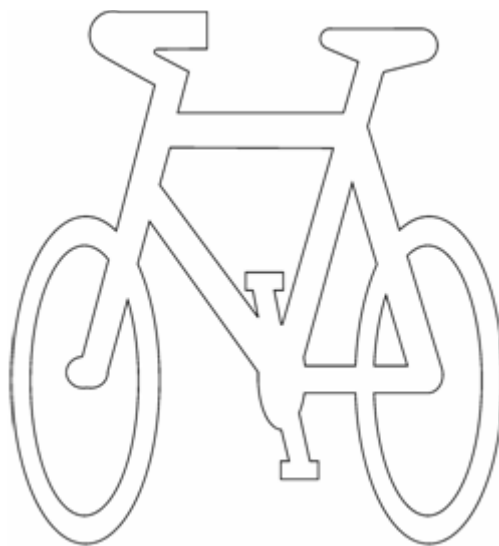

All new cycle lane symbol markings should, by 30 June 2009, be in the form of M2-3 cycle lane symbol.

M2-3B **Sharrow symbol**

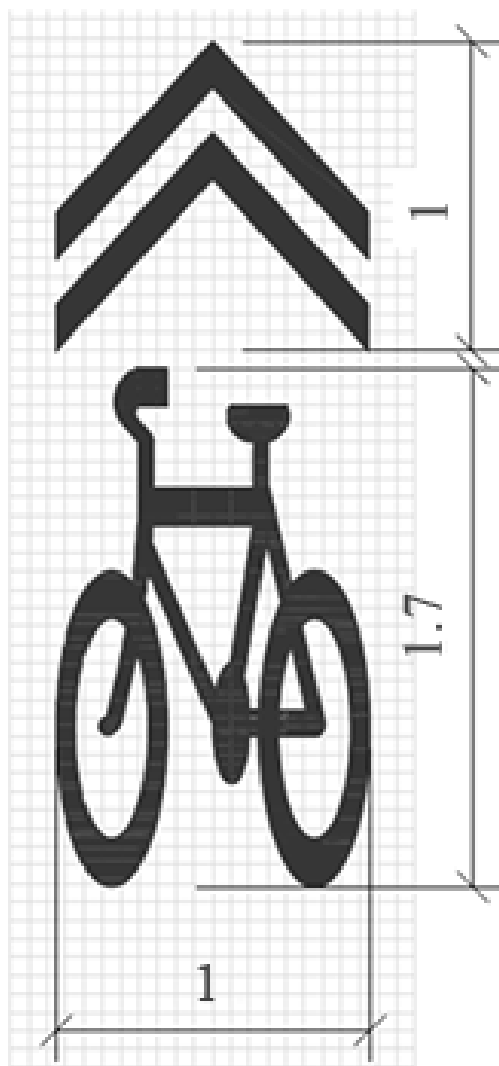

M2-3C **Cycle path or shared path crossing driveway**

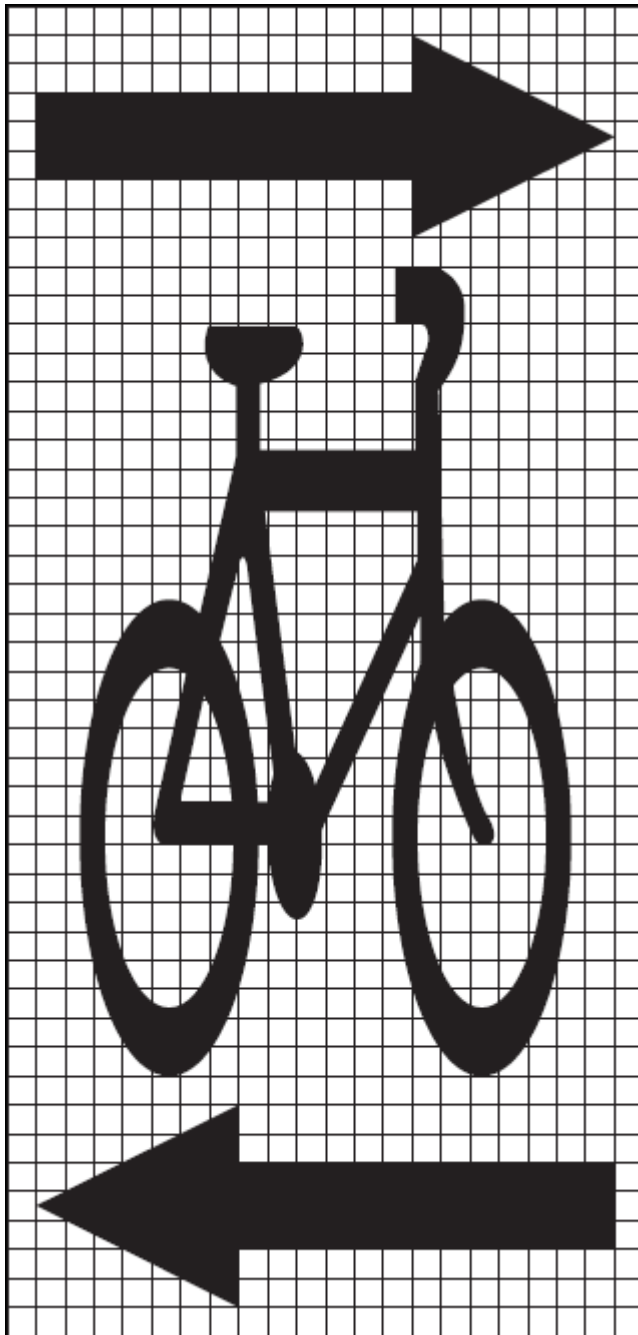

Grid size: 50 mm minimum

Note: for a one-way path, either arrow may be omitted and the cycle symbol may be reversed so that the remaining arrow and the cycle symbol indicate the direction of travel.

M2-3D **Cycle path or shared path crossing driveway – alternative
for narrow paths**

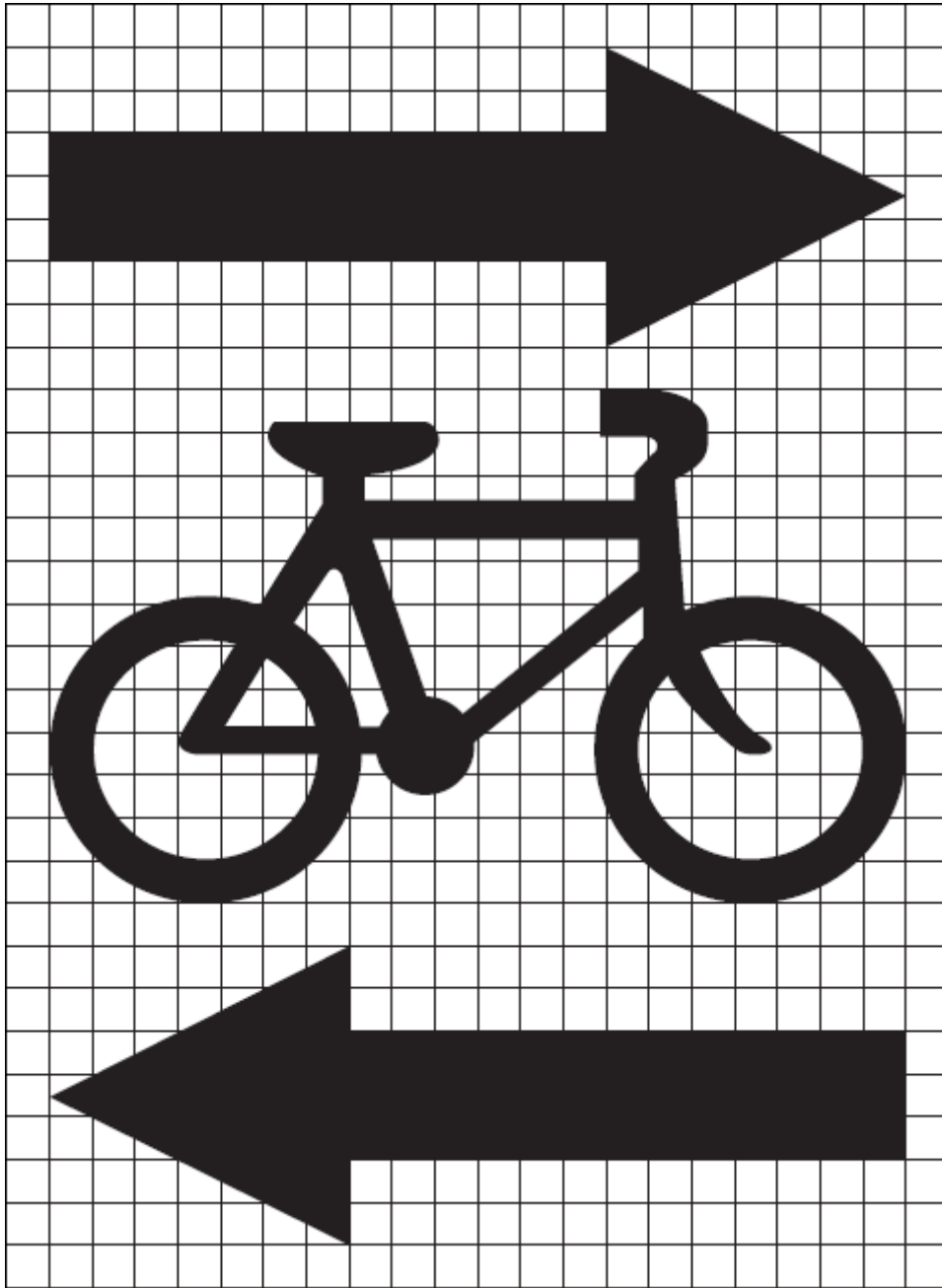

Grid size: 50 mm minimum

Note: for a one-way path, either arrow may be omitted and the cycle symbol may be reversed so that the remaining arrow and the cycle symbol indicate the direction of travel.

M2-3E **Alternative cycle symbol marking for shared paths**

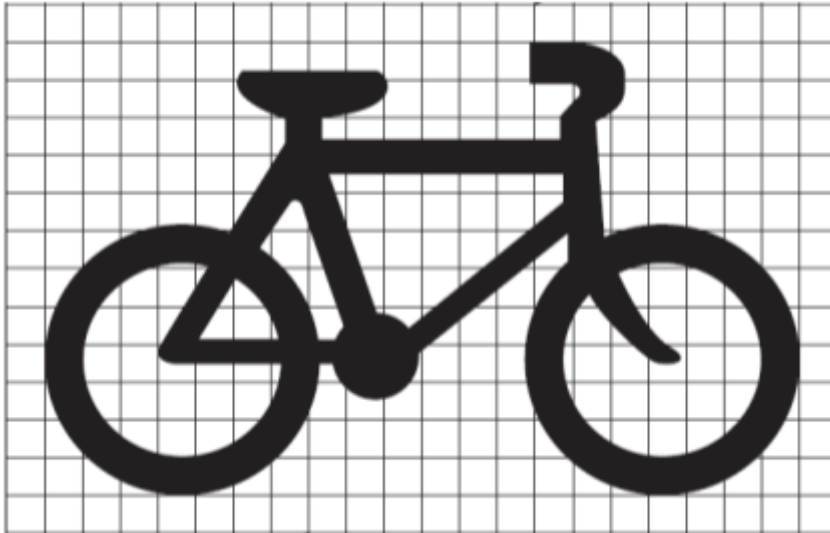

Grid size: 20mm minimum

Note: The cycle symbol may be reversed to indicate the direction of travel.

M2-4 Pedestrian symbol

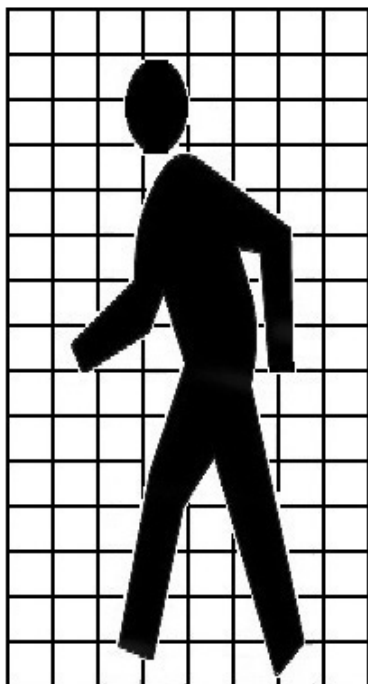

M2-5 Heavy vehicle lane

Letter height: 2400 mm (urban), 3600 mm (rural)

Colour: white

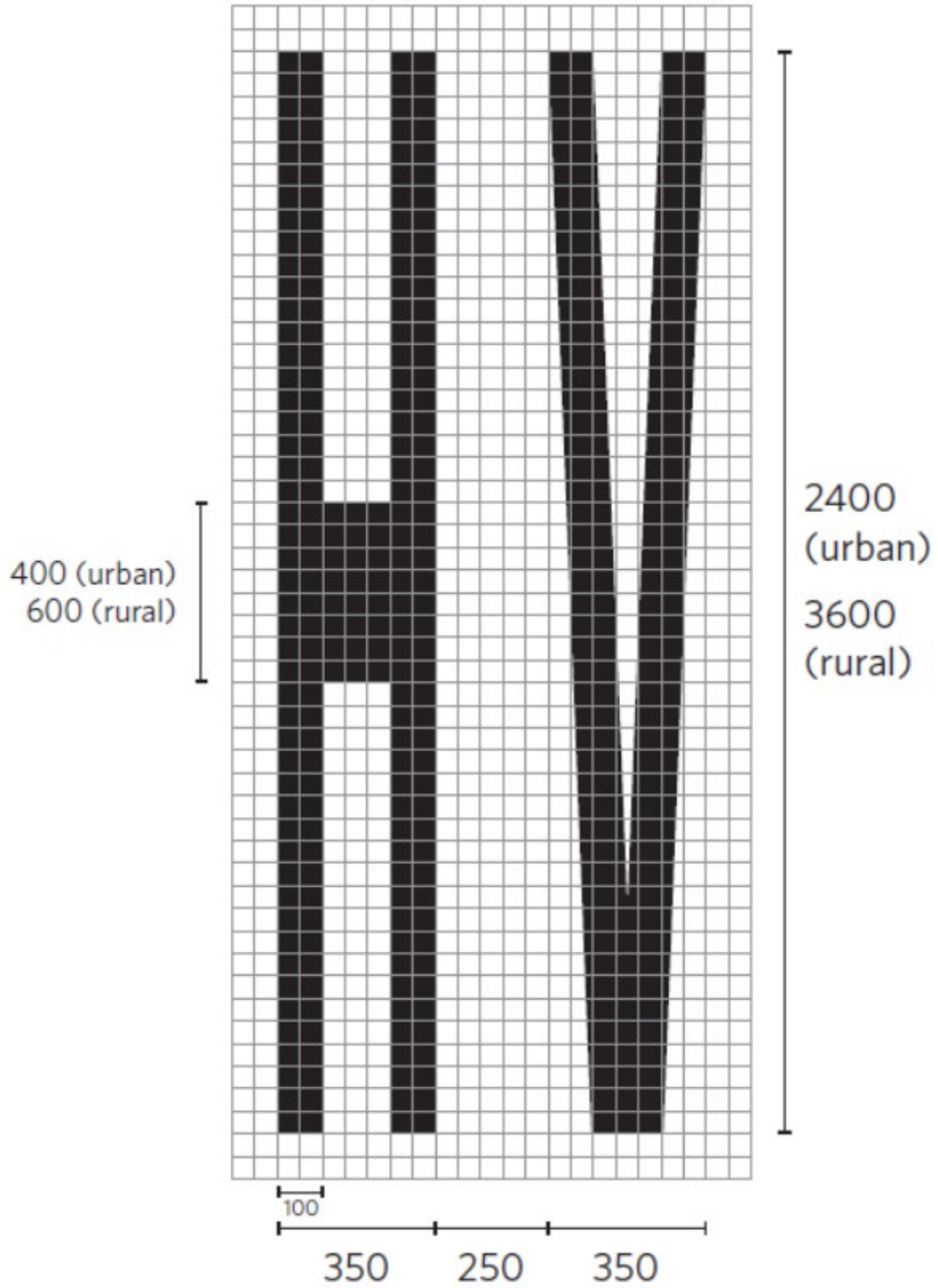

M2-6 Electric vehicle lane

Letter height: 2400 mm (urban), 3600 mm (rural)

Colour: white

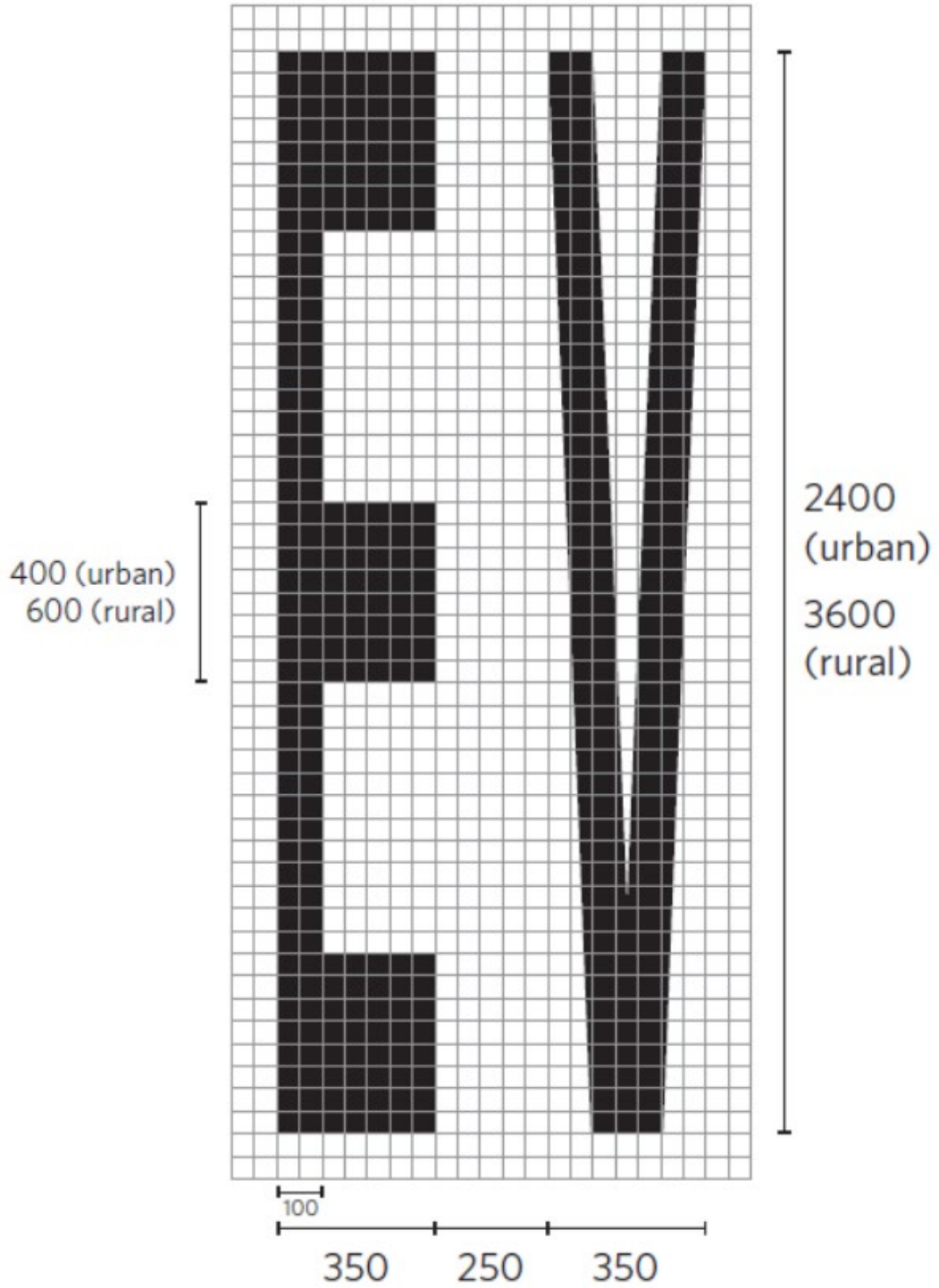

M3-1 Small passenger service vehicle stand

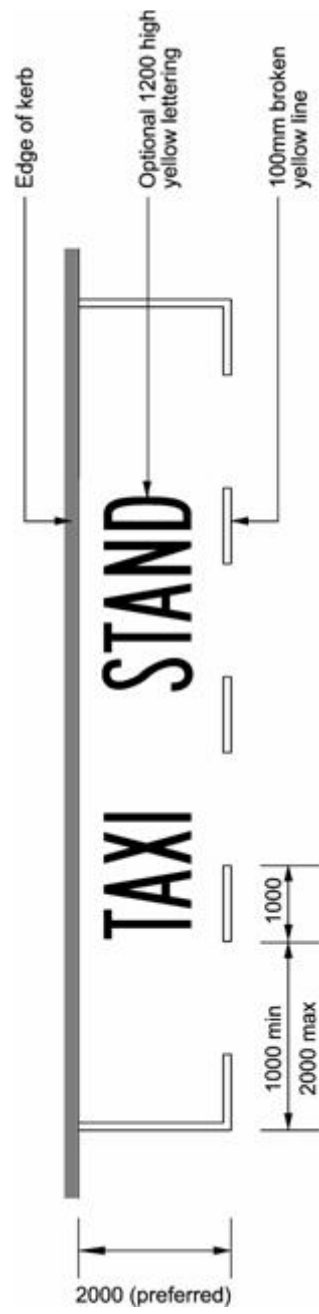

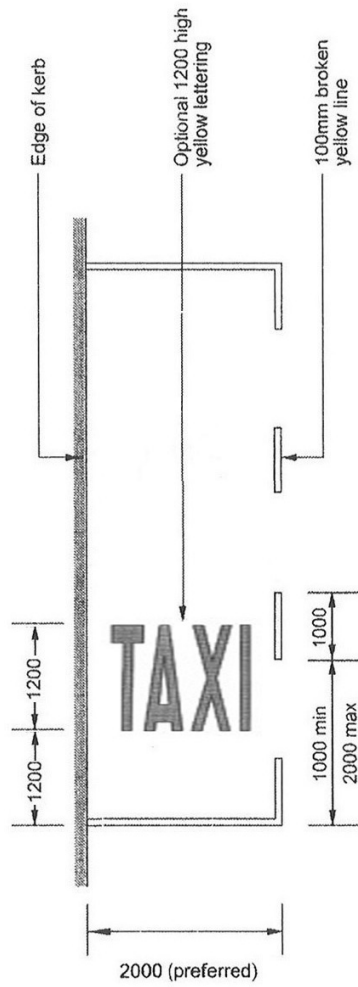

M3-1A Small passenger service vehicle stand alternative

M3-2 Bus stop

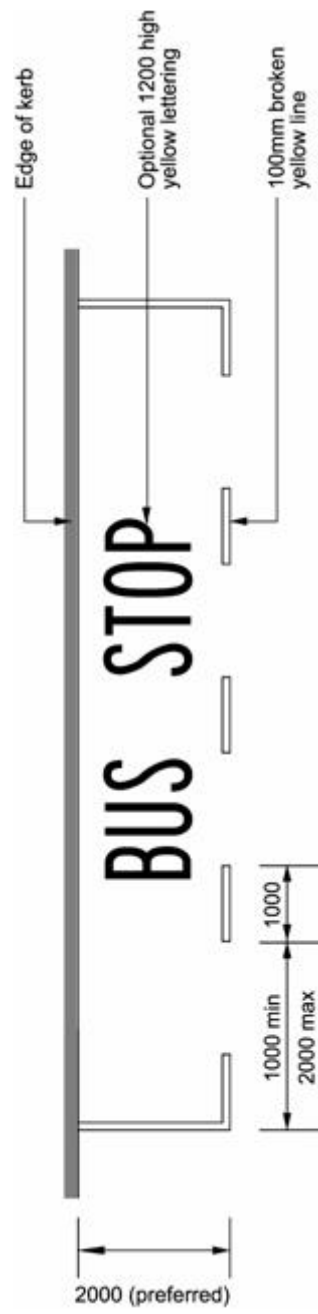

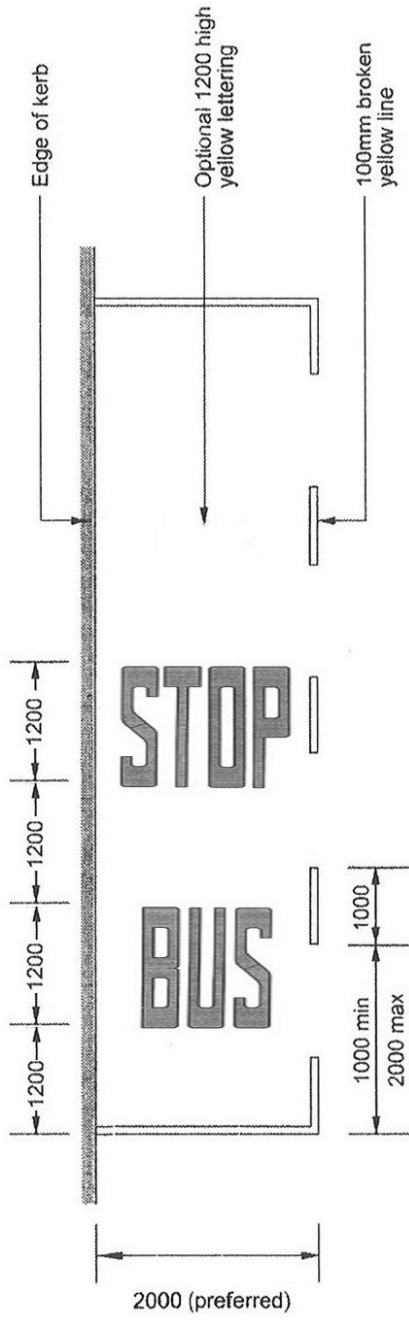

M3-2A Bus stop alternative

M3-3 Loading zone

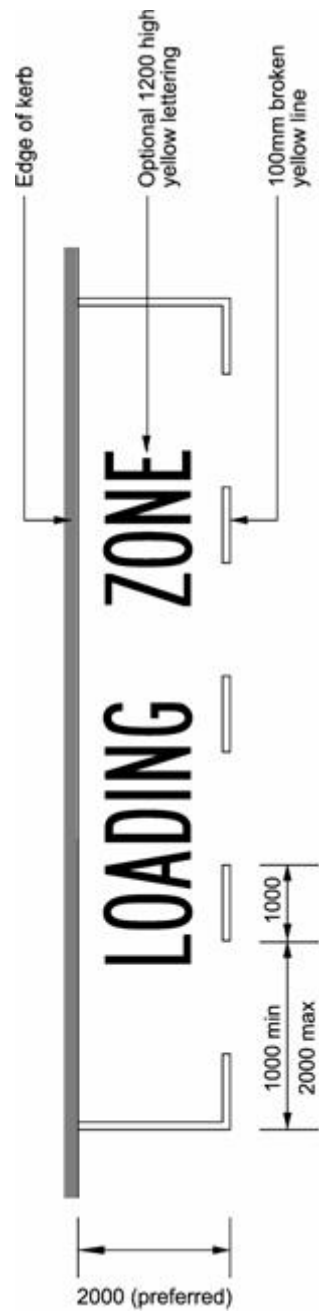

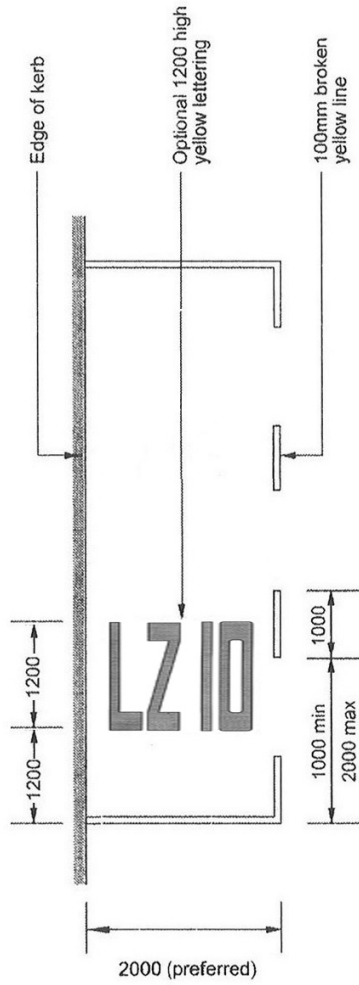

M3-3A Loading zone alternative – example maximum 10 minutes

M3-4 Motorcycle and cycle stand

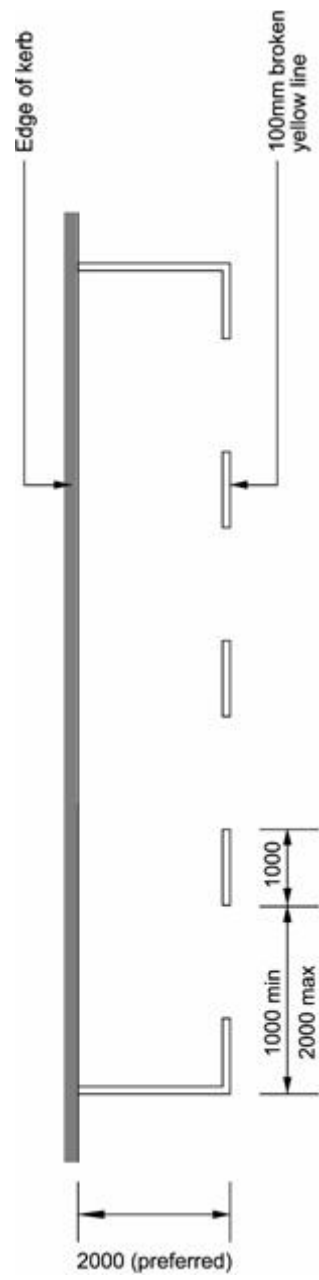

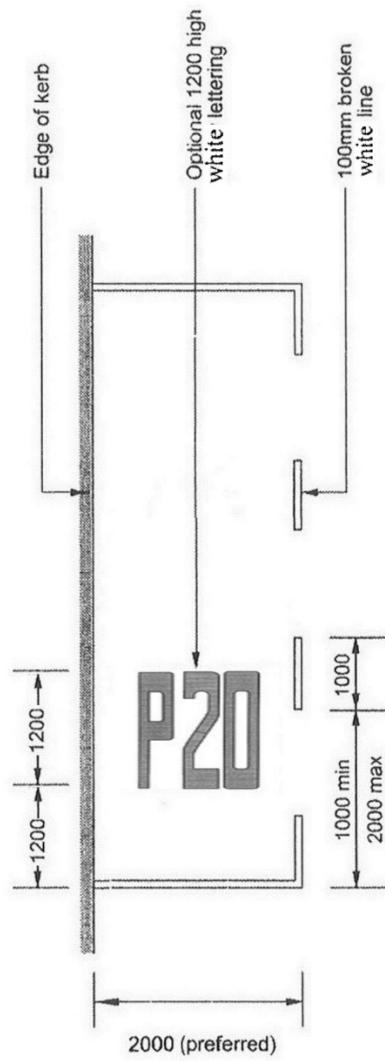

M3-4A Time limited parking – example P20 parking limited to 20 minutes

M3-5

Disabled parking symbol

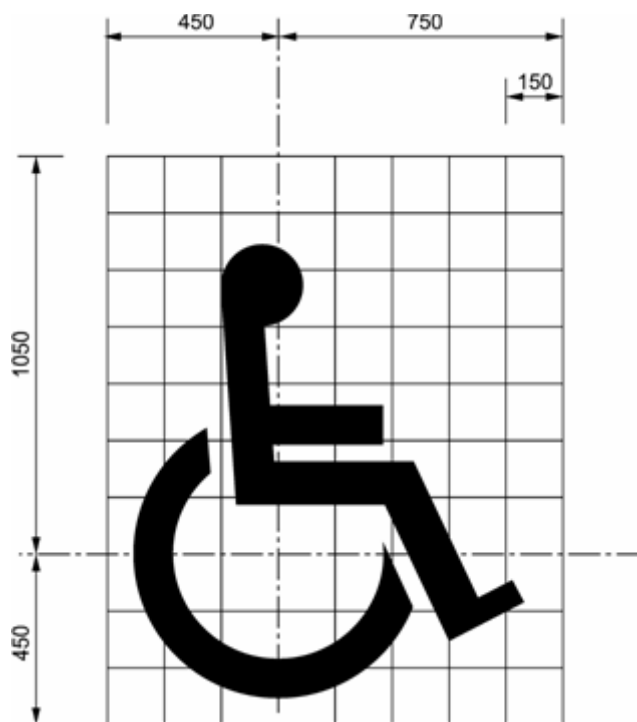

M3-6 Electric vehicle charging station symbol

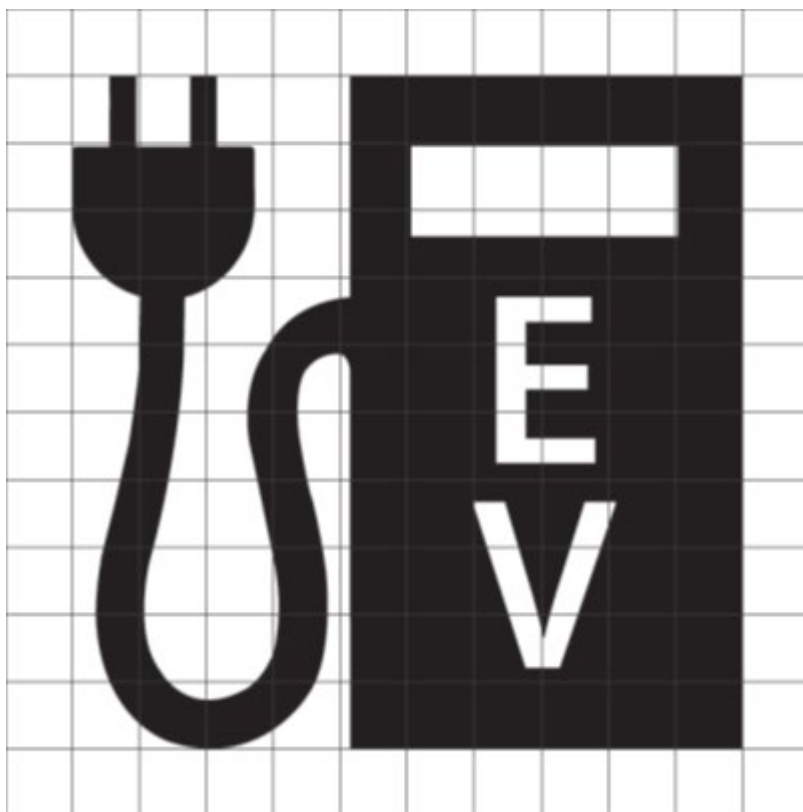

Grid size: 100 mm minimum

Colour: yellow

M4-1 **Keep clear word message**

Letter height: 2400 mm



M4-2 **Keep clear cross-hatching**

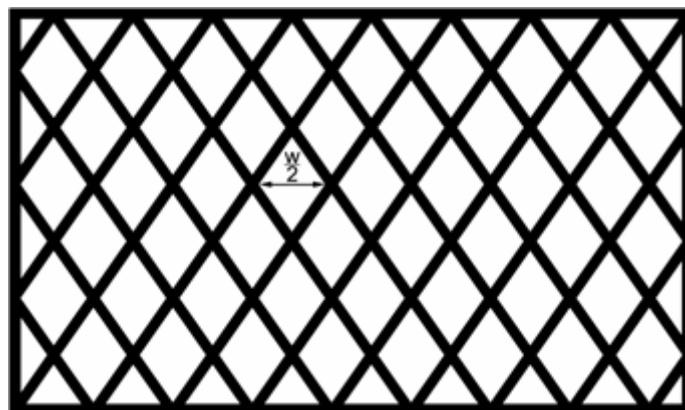

Size of diamond to be half the lane width (W). Width of lines to be 100 mm.

M5-1 Advance warning 'RAIL X' markings



M6-1 'Stop' word message

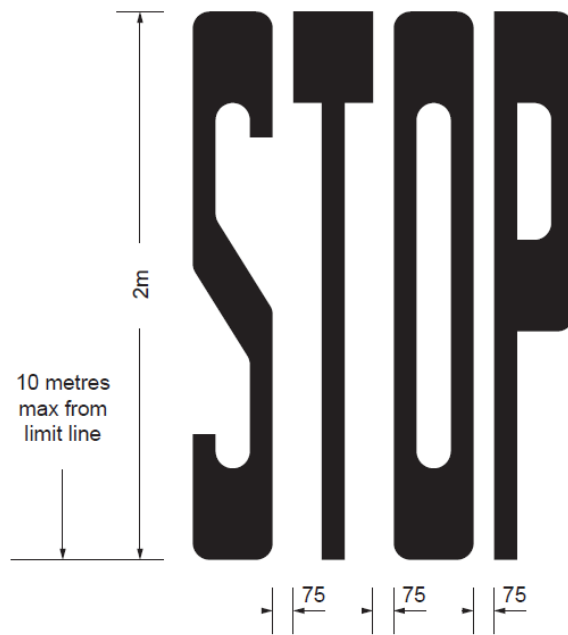

Schedule 2, diagram **M6-1**: amended, on 6 October 2006, by clause 4.2(b) of Land Transport Rule: Traffic Control Devices Amendment 2006.

M6-2

'Give way' triangle symbol

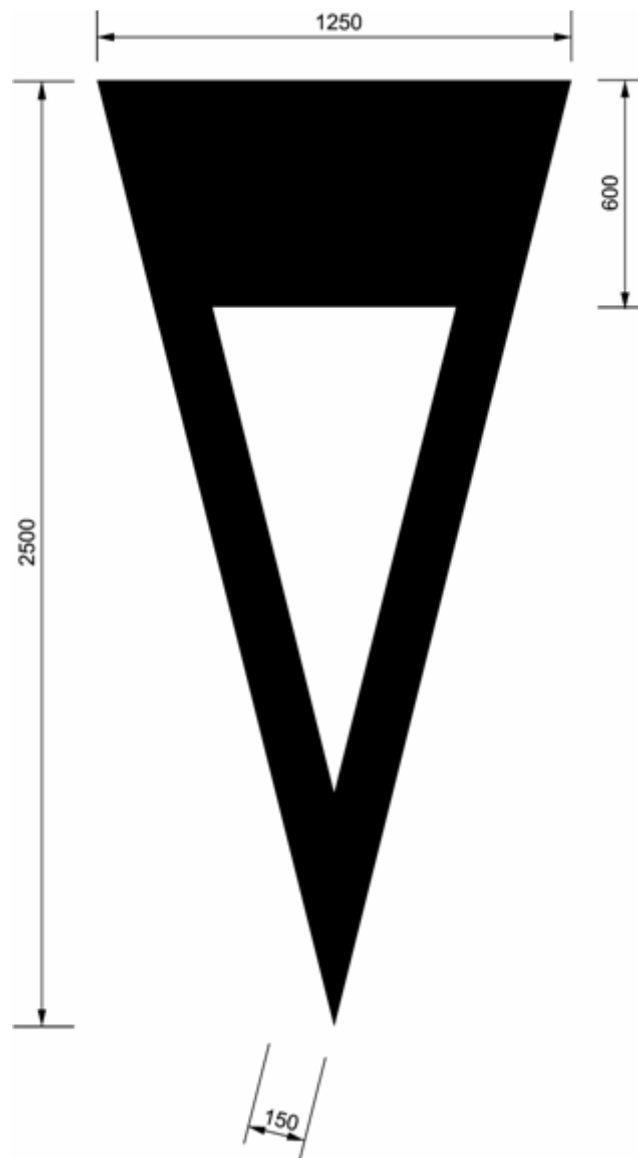

M6-2.1 'Give way' word message

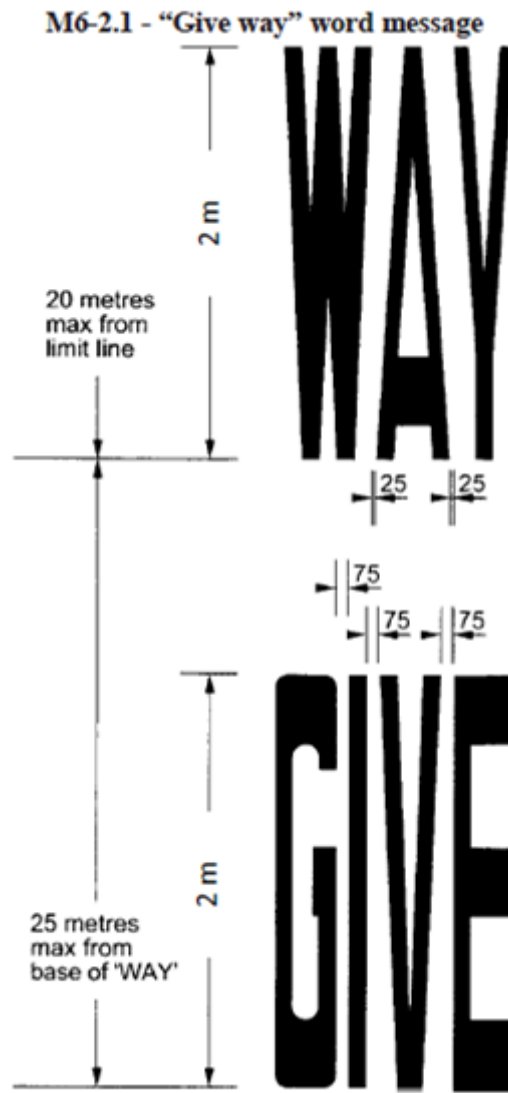

Existing markings in this form may be maintained.

All new give way markings should be in the form of M6-2 'Give way' triangle symbol, see 9.4(6), 10.3(2) and 10.4(3).

[Ref. Cl. 7.12(3)(a)]

M7-1 Lane use arrows

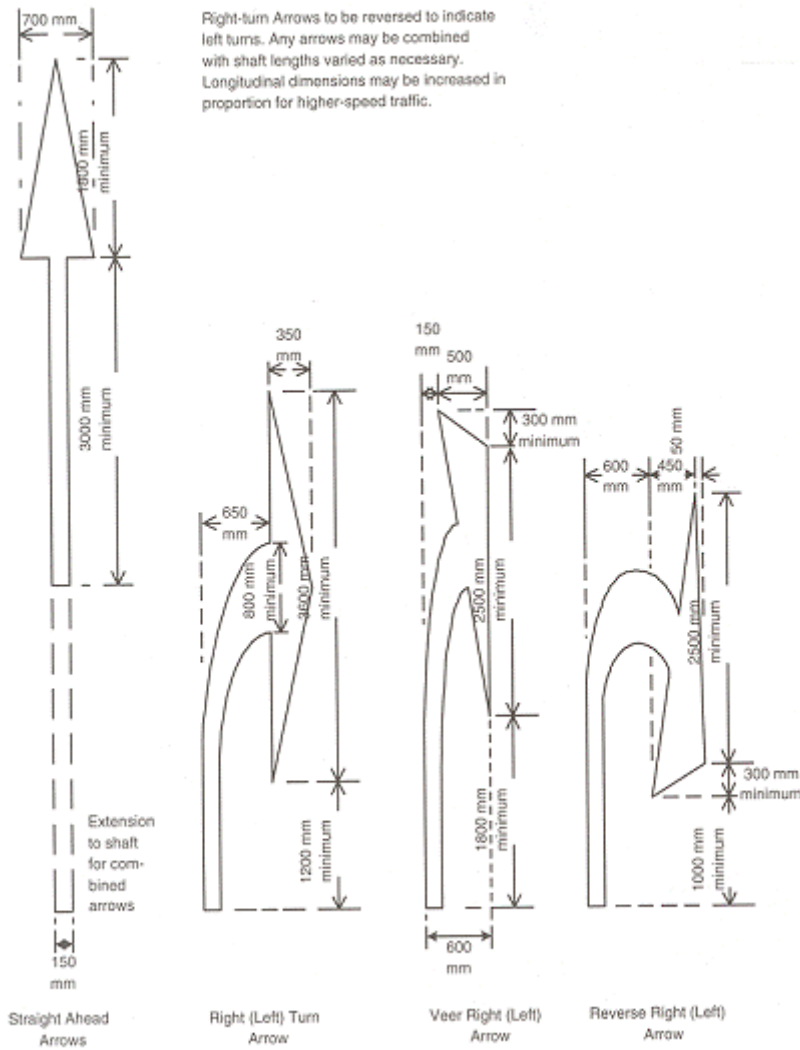

M8-1 Numbers for road markings

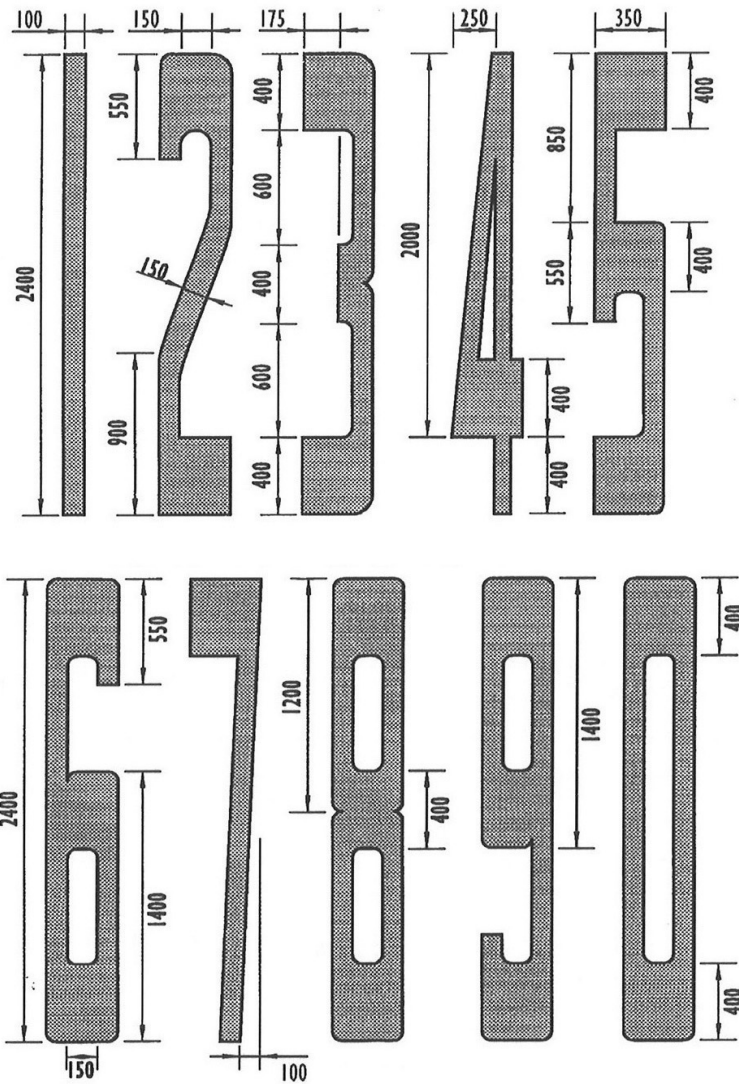

NOTES:

1. Where shown, corners can be rounded to nominal 75 mm radius.
2. Except where shown otherwise, width of vertical and near vertical strokes is 100 mm.
3. Height (vertical dimension) of all horizontal strokes is 400 mm.
4. Width of all numerals except '1' is 350 mm.
5. Spaces between all numerals are 75 mm.
6. Dimensions given are for numerals 2.4 m high to be used in urban areas. In rural areas, vertical dimensions should be increased by 50%.
7. For commercial stops and other parking spaces, vertical dimensions may be decreased by 50%.
8. For pedestrians and cyclists, the dimensions of each numeral may be decreased in accordance with 5.4(2A).

M8-2 Letters for road markings – A to J

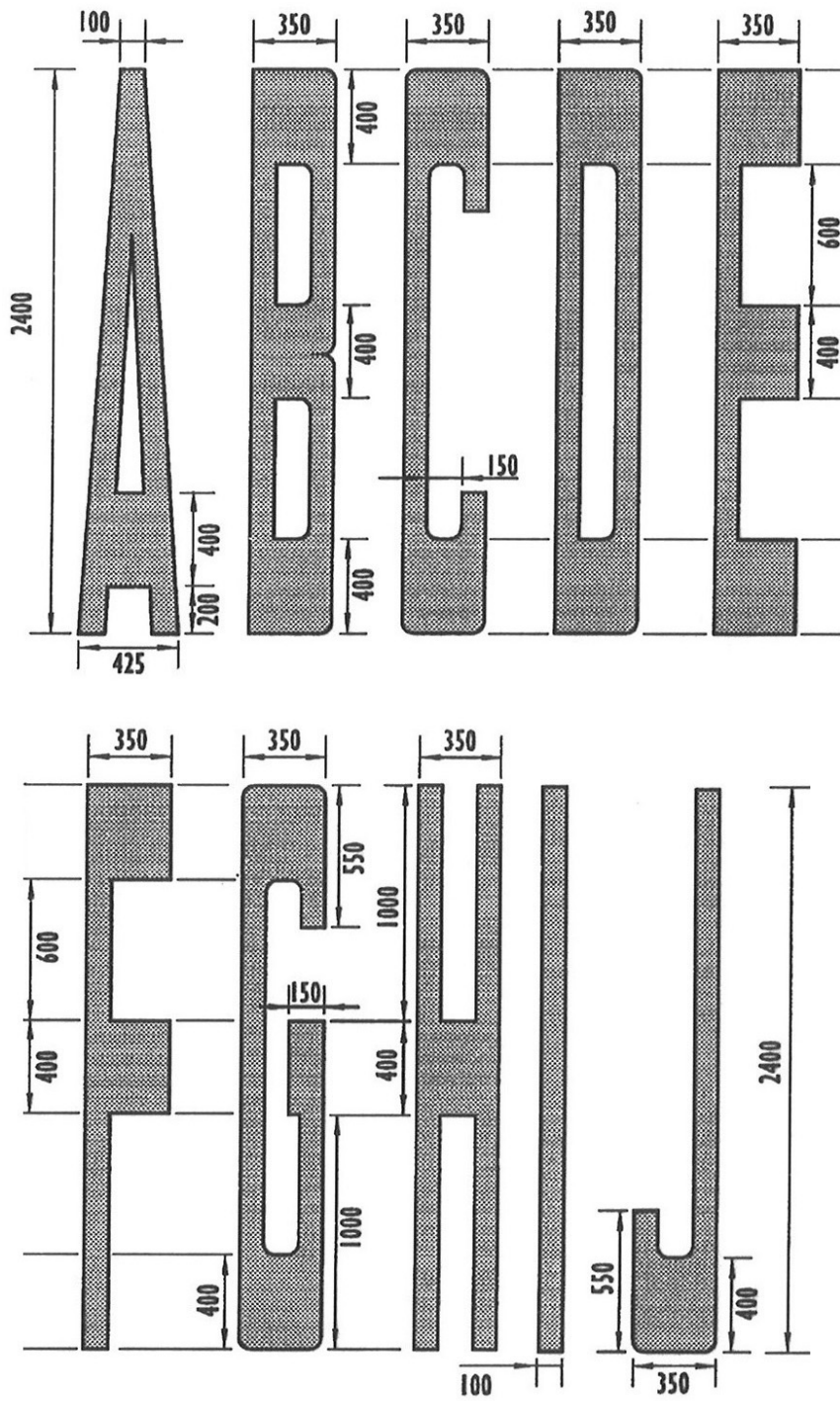

NOTES:

1. Where shown, corners should be rounded to nominal 75 mm radius.
2. Width of vertical and near vertical strokes is 100 mm.
3. Height (vertical dimension) of all horizontal strokes is 400 mm.
4. Space between all letters except A, W and X is 75 mm. Space between A, W or X and another letter is 25 mm.
5. Dimensions given are for letters 2.4 m high to be used in urban areas. In rural areas, vertical dimensions should be increased by 50%.
6. For commercial vehicle stops and other parking spaces, vertical dimensions may be reduced 50%.
7. For pedestrians and cyclists, the dimensions of each letter may be decreased in accordance with 5.4(2A).

M8-2 Letters for road markings – K to T

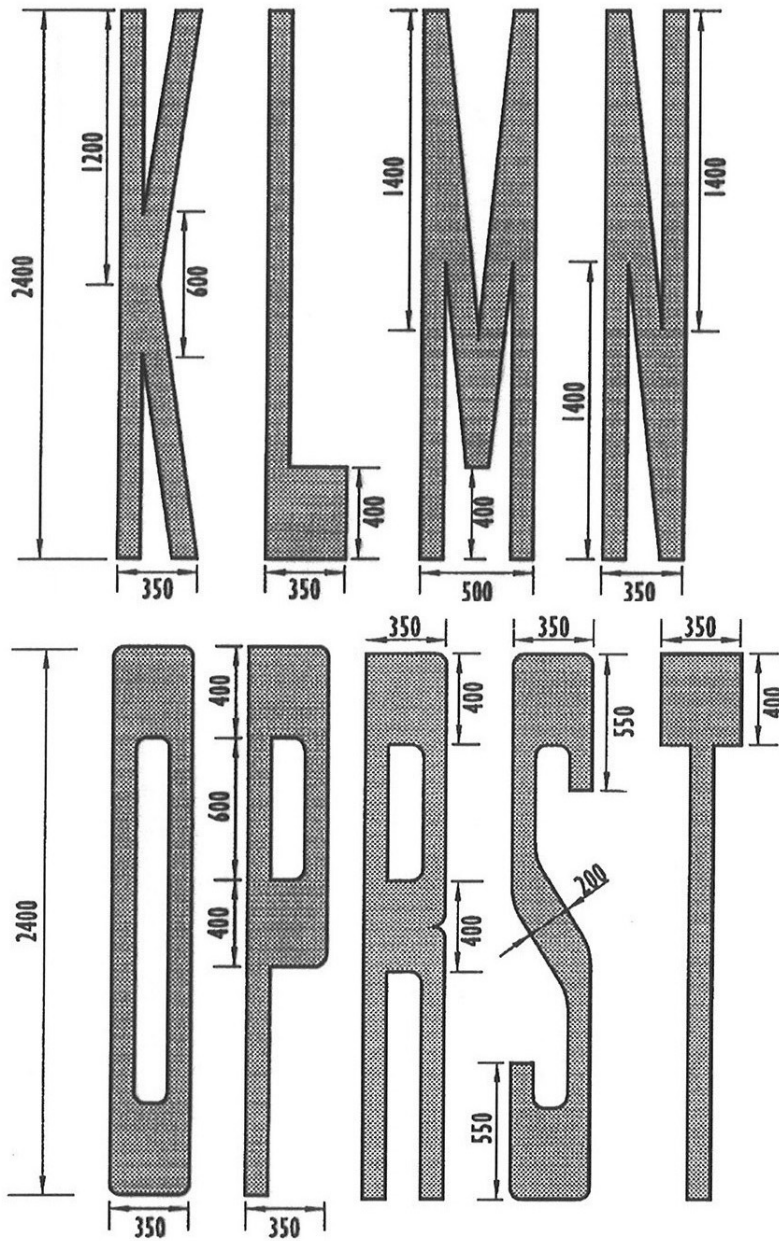

NOTES:

1. Where shown, corners should be rounded to nominal 75 mm radius.
2. Width of vertical and near vertical strokes is 100 mm.
3. Height (vertical dimension) of all horizontal strokes is 400 mm.
4. Space between all letters except A, W and X is 75 mm. Space between A, W or X and another letter is 25 mm.
5. Dimensions given are for letters 2.4 m high to be used in urban areas. In rural areas, vertical dimensions should be increased by 50%.
6. For commercial vehicle stops and other parking spaces, vertical dimensions may be reduced 50%.
7. For pedestrians and cyclists, the dimensions of each letter may be decreased in accordance with 5.4(2A).

M8-2 Letters for road markings – U to Z, ‘&’, ‘apostrophe’ and ‘/’

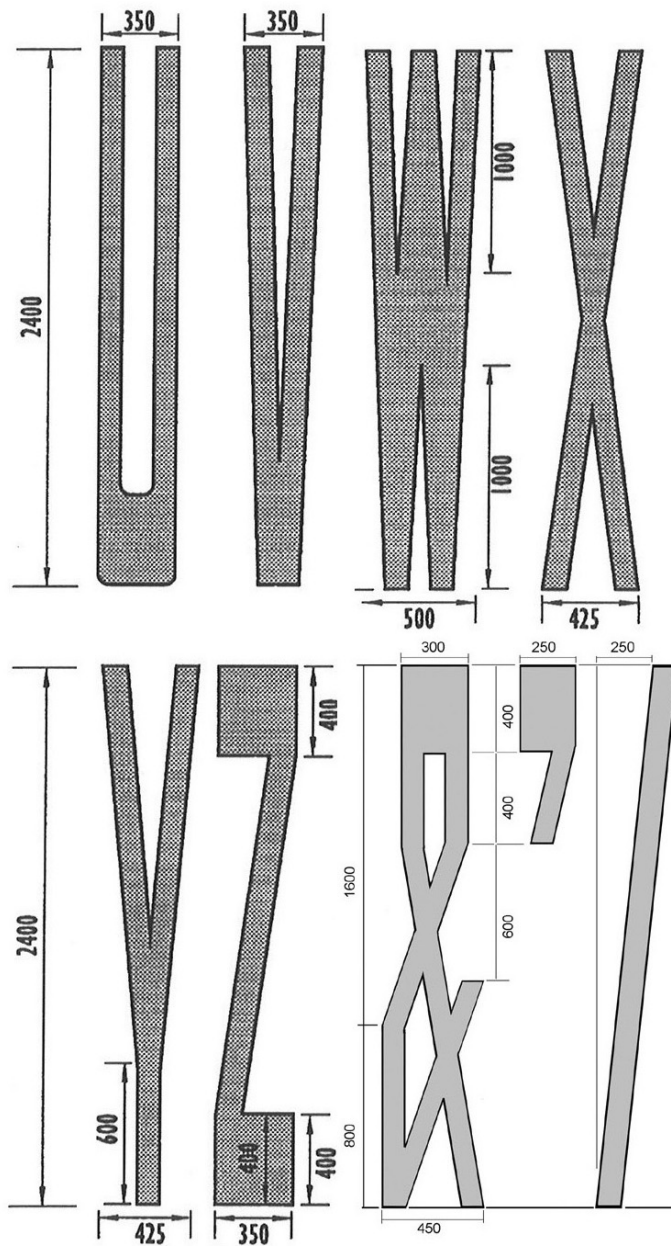

NOTES:

1. Where shown, corners should be rounded to nominal 75 mm radius.
 2. Width of vertical and near vertical strokes is 100 mm.
 3. Height (vertical dimension) of all horizontal strokes is 400 mm.
 4. Space between all letters except A, W and X is 75 mm. Space between A, W or X and another letter is 25 mm.
 5. Dimensions given are for letters 2.4 m high to be used in urban areas. In rural areas, vertical dimensions should be increased by 50%.
 6. For commercial vehicle stops and other parking spaces, vertical dimensions may be reduced 50%.
7. For pedestrians and cyclists, the dimensions of each letter or symbol may be decreased in accordance with 5.4(2A).

Schedule 2, item **M1-4**: inserted, on 1 April 2011, by clause 4.2 of *Land Transport Rule: Traffic Control Devices Amendment 2010*.

Schedule 2, item **M1-4**: amended, on 1 May 2021, by clause 2.5(1) of *Land Transport Rule: Traffic Control Devices Amendment 2021*.

Schedule 2, item **M2-3**: amended, on 1 June 2019, by clause 2.13(1) of *Land Transport Rule: Traffic Control Devices Amendment 2019*.

Schedule 2, item **M2-4**: inserted, on 1 April 2011, by clause 4.2 of *Land Transport Rule: Traffic Control Devices Amendment 2010*.

Schedule 2, item **M2-5**: inserted, on 1 September 2017, by clause 7(4) of *Land Transport Rule: Traffic Control Devices Amendment 2017*.

Schedule 2, item **M2-6**: inserted, on 1 September 2017, by clause 7(4) of *Land Transport Rule: Traffic Control Devices Amendment 2017*.

Schedule 2, item **M2-3B**: inserted, on 1 December 2016, by clause 2.5 of *Land Transport Rule: Traffic Control Devices Amendment 2016*.

Schedule 2, item **M2-3C**: inserted, on 1 June 2019, by clause 2.13(5) of *Land Transport Rule: Traffic Control Devices Amendment 2019*.

Schedule 2, item **M2-3D**: inserted, on 1 June 2019, by clause 2.13(5) of *Land Transport Rule: Traffic Control Devices Amendment 2019*.

Schedule 2, item **M2-3E**: inserted, on 1 June 2019, by clause 2.13(5) of *Land Transport Rule: Traffic Control Devices Amendment 2019*.

Schedule 2, item **M3-1**: amended, on 1 June 2019, by clause 2.13(2) of *Land Transport Rule: Traffic Control Devices Amendment 2019*.

Schedule 2, item **M3-1A**: amended, on 1 June 2019, by clause 2.13(3) of *Land Transport Rule: Traffic Control Devices Amendment 2019*.

Schedule 2, item **M3-1A**: inserted, on 1 April 2011, by clause 4.2 of *Land Transport Rule: Traffic Control Devices Amendment 2010*.

Schedule 2, item **M3-2A**: inserted, on 1 April 2011, by clause 4.2 of *Land Transport Rule: Traffic Control Devices Amendment 2010*.

Schedule 2, item **M3-3A**: inserted, on 1 April 2011, by clause 4.2 of *Land Transport Rule: Traffic Control Devices Amendment 2010*.

Schedule 2, item **M3-4A**: amended, on 1 January 2014, by clause 4.2 of *Land Transport Rule: Traffic Control Devices Amendment 2013*.

Schedule 2, item **M3-4A**: inserted, on 1 April 2011, by clause 4.2 of *Land Transport Rule: Traffic Control Devices Amendment 2010*.

Schedule 2, item **M3-6**: inserted, on 1 September 2017, by clause 7(5) of *Land Transport Rule: Traffic Control Devices Amendment 2017*.

Schedule 2, item **M6-2.1**: amended, on 1 June 2019, by clause 2.13(4) of *Land Transport Rule: Traffic Control Devices Amendment 2019*.

Schedule 2, diagram **M6-2.1**: replaced, on 6 October 2006, by clause 4.2(b) of *Land Transport Rule: Traffic Control Devices Amendment 2006*.

Schedule 2, item **M7-1**: inserted, on 15 September 2005, by clause 4.2 of *Land Transport Rule: Traffic Control Devices Amendment 2005*.

Schedule 2, item **M8-1**: amended, on 1 November 2014, by clause 4.1(7) of *Land Transport Rule: Traffic Control Devices Amendment 2014*.

Schedule 2, item **M8-1**: inserted, on 1 April 2011, by clause 4.2 of *Land Transport Rule: Traffic Control Devices Amendment 2010*.

Schedule 2, item **M8-2** – *Letters for road markings – A to J*: amended, on 1 November 2014, by clause 4.1(8) of *Land Transport Rule: Traffic Control Devices Amendment 2014*.

Schedule 2, item **M8-2** – *Letters for road markings – K to T*: amended, on 1 November 2014, by clause 4.1(9) of *Land Transport Rule: Traffic Control Devices Amendment 2014*.

Schedule 2, item **M8-2** – *Letters for road markings – U to Z, '&', 'apostrophe' and '/'*: amended, on 1 November 2014, by clause 4.1(10) of *Land Transport Rule: Traffic Control Devices Amendment 2014*.

Schedule 2, item **M8-2**: inserted, on 1 April 2011, by clause 4.2 of *Land Transport Rule: Traffic Control Devices Amendment 2010*.

Schedule 3 Traffic signals

- All measurements are shown in millimetres, unless otherwise indicated.

S1 Disc and arrow displays

S1-1 Disc

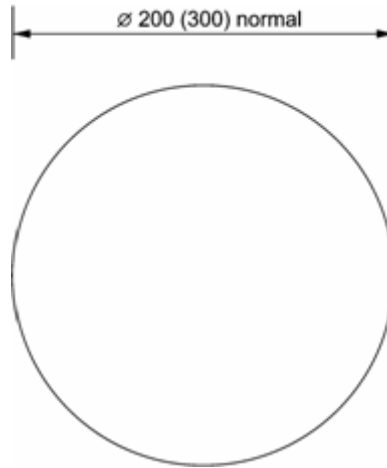

S1-2 Arrow

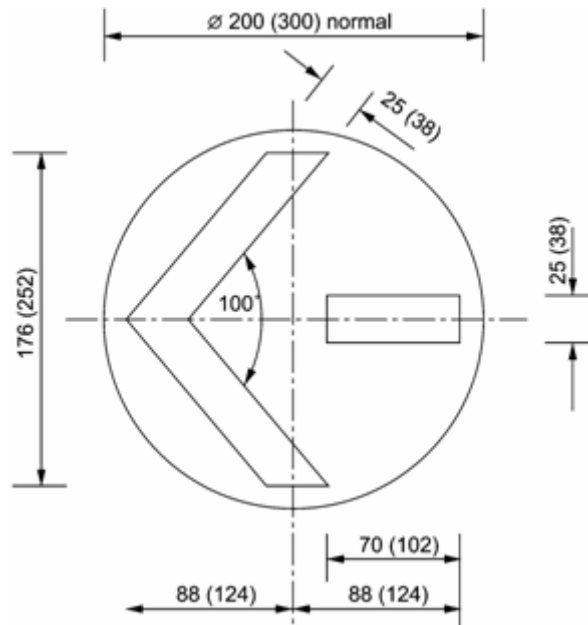

S1-2.1 Left turn 90° or more

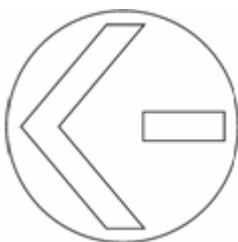

S1-2.2 Left turn less than 90°

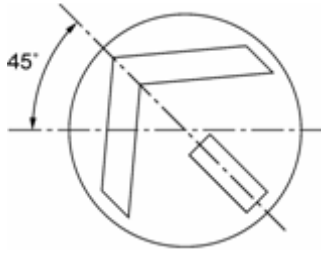

S1-2.3 Straight through



S1-2.4 Right turn less than 90°

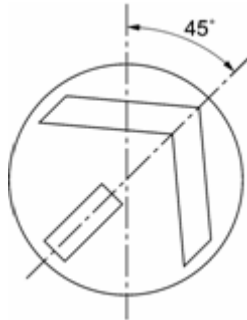

S1-2.5 Right turn 90° or more

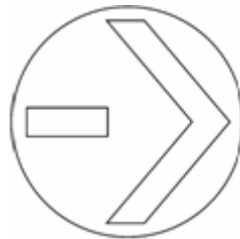

S2 Special vehicle displays

S2-1 Bus 'B' symbol

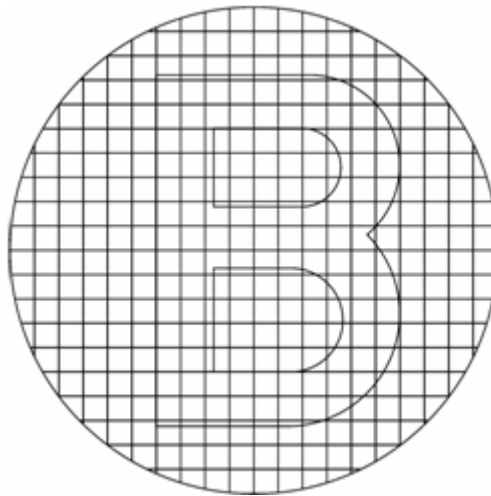

S2-2 Light-rail vehicle 'T' symbol

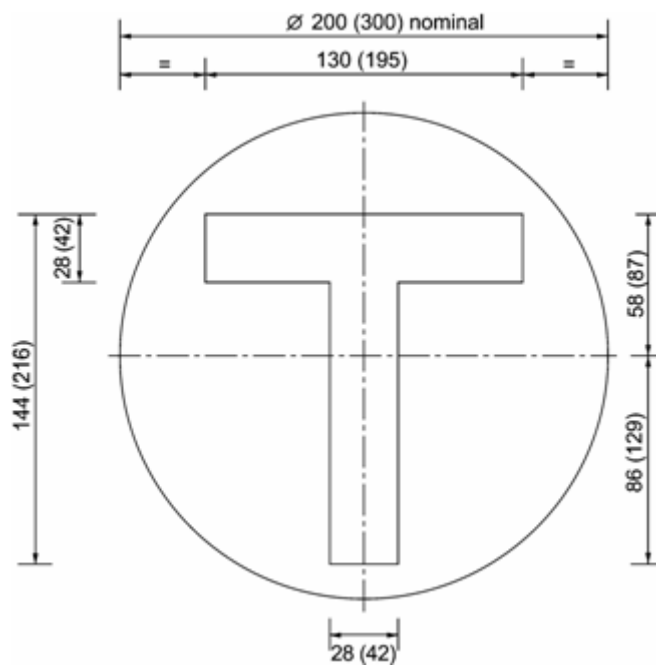

S2-3 Cycle symbol

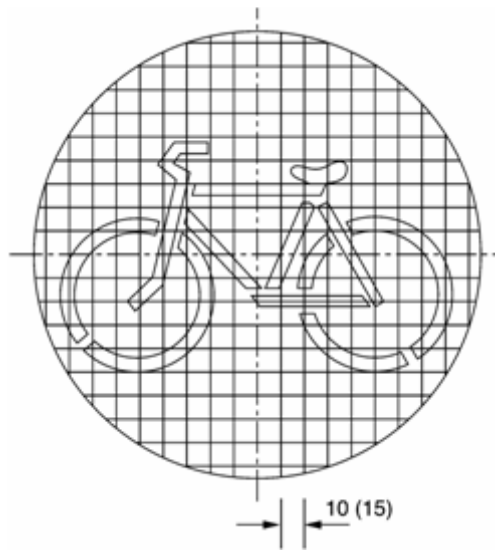

S3 Pedestrian displays

S3-1 Pedestrian 'standing human' symbol

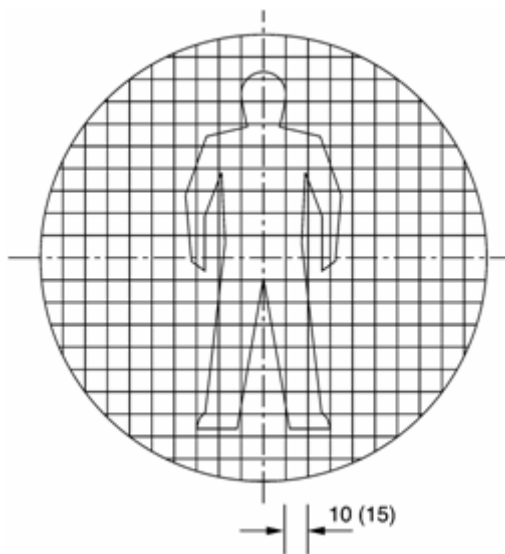

The standing human figure used in a nearside pedestrian display, described in 6.6(5), must be of a similar shape to that specified in S3-1 with the symbol at least 100 mm high and 45 mm wide and may be located within a rectangular lantern.

S3-1.1 Pedestrian 'standing human' symbol LED version

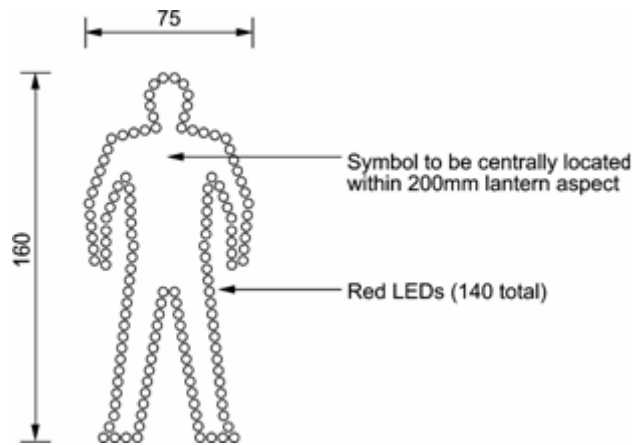

S3-2 Pedestrian 'walking human' symbol

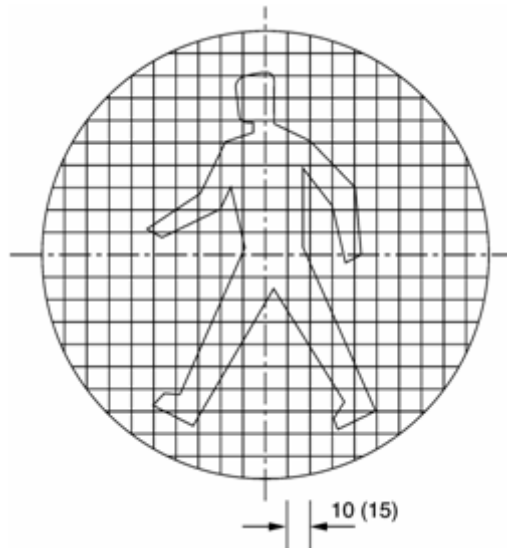

The walking human figure used in a nearside pedestrian display, described in 6.6(5), must be of a similar shape to that specified in S3-2 with the symbol at least 100 mm high and 60 mm wide and may be located within a rectangular lantern.

S3-2.1 Pedestrian 'walking human' symbol LED version

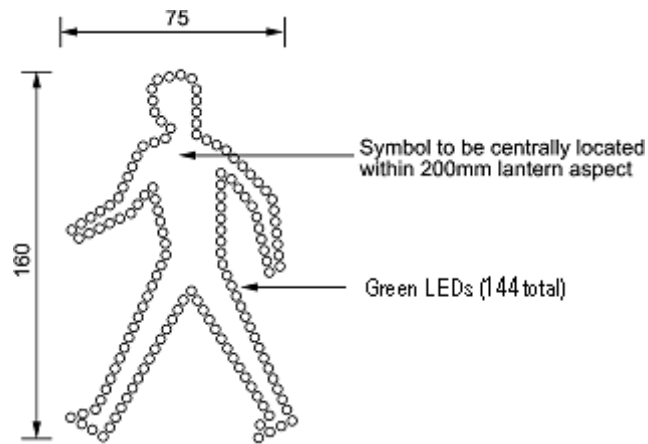

S3-3 Countdown signal displays

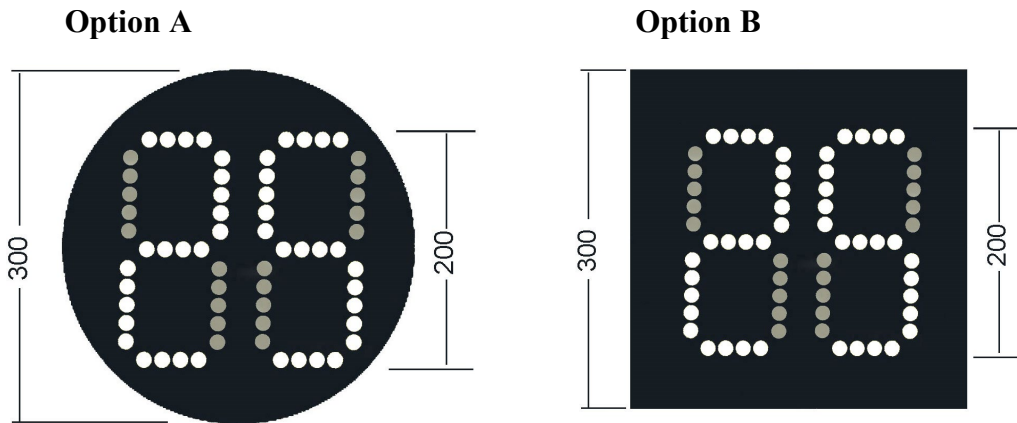

[Note: these diagrams display the number '25' for illustrative purposes.]

During the period when the steady green human symbol is displayed the countdown display may display a green, lit 'dynamic' image of a human walking. The 'dynamic' image must be in the general form of the 'walking human' symbol depicted in S3-2 or S3-2.1 of this schedule. The 'arms' and 'legs' of the symbols may be displayed in positions representing stages of the image walking.

The dynamic effect is achieved by the display of four (or more) images which are shown sequentially at a frequency which gives the impression of the human figure moving at a steady walking pace. An example is depicted below.

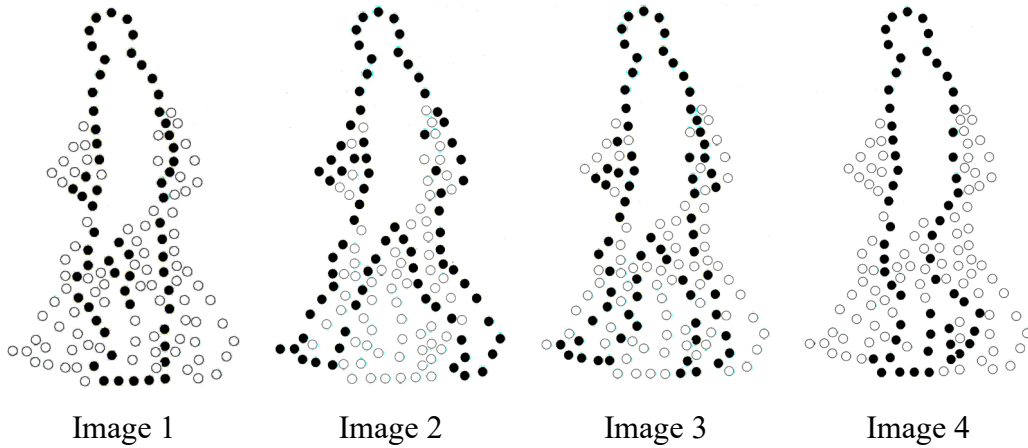

[Note the solid circles depict lit LEDs while the rings depict unlit LEDs]

S4 Permitted steady signal displays

S4-3 Single-column 3-aspect

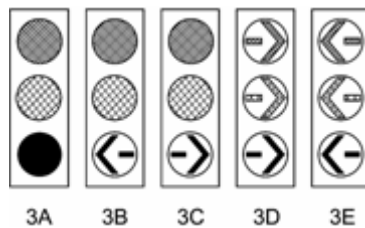

S4-4 Single-column 4-aspect

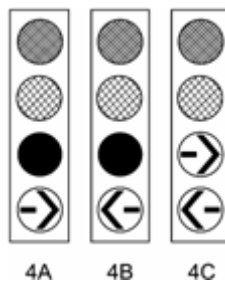

S4-4 Two-column 4-aspect

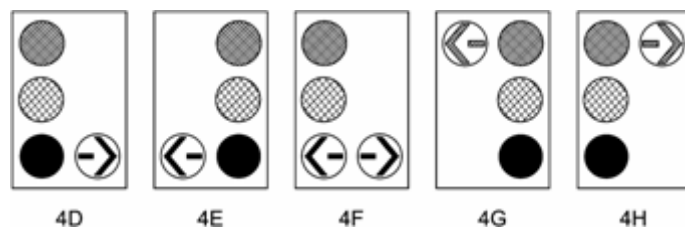

S4-5 Two-column 5-aspect

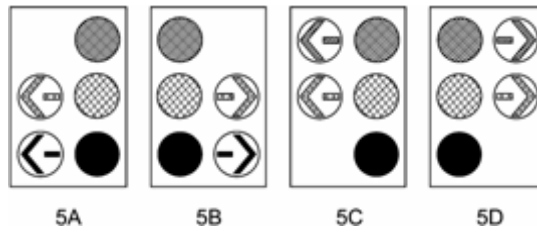

S4-5 Three-column 5-aspect

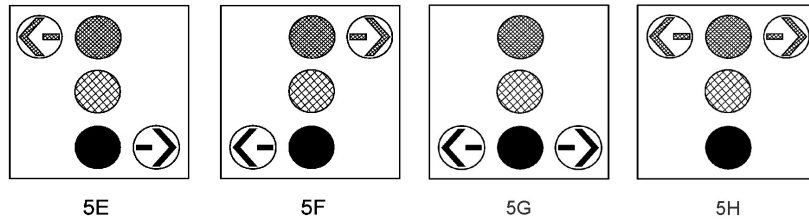

S4-6 Two-column 6-aspect

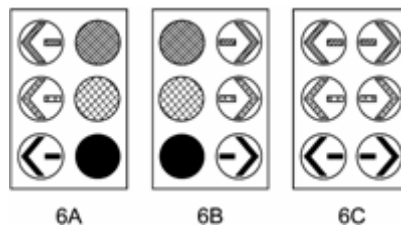

S4-6 Three-column 6-aspect

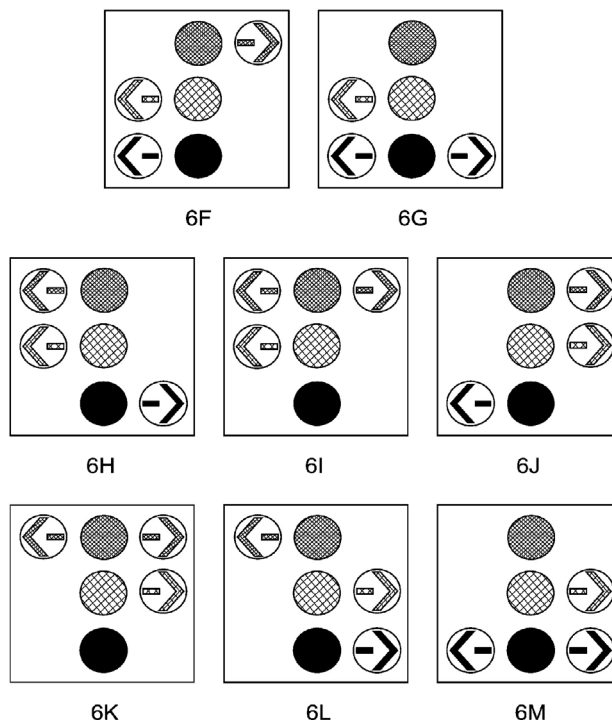

S4-10 Special vehicle displays

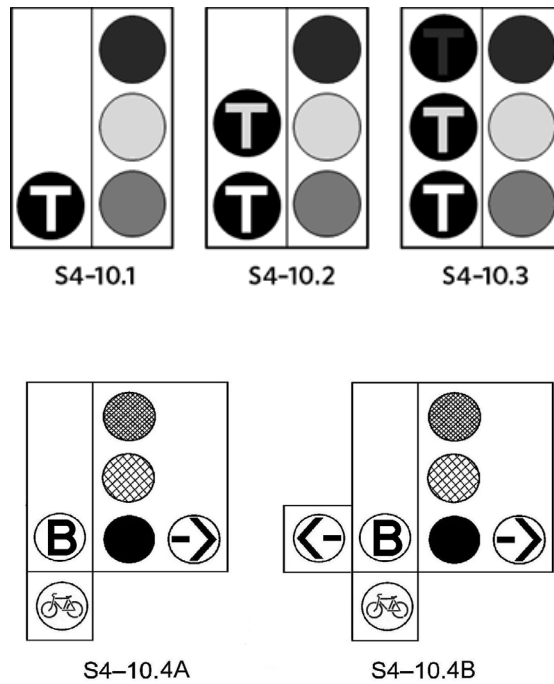

Special vehicle displays are installed alongside, or as an additional column within, one of the displays depicted as items 3A to 9A in this *Schedule*. The symbols, represented by the 'T' in the diagrams above, may be:

- 'T' symbol for light-rail vehicles
- 'B' symbol for buses
- 'Cycle' symbol for cycles.

If the signals control only the movement of light-rail vehicles, buses or cycles, a single column of three T, B or cycle symbols may be installed.

A green 'cycle' symbol for cycles may be installed below a white 'B' symbol for buses as depicted in diagram S4-10.4A or S4-10.4B.

Schedule 3, text after diagram **S3-1**: inserted, on 1 April 2011, by *clause 4.3(a) of Land Transport Rule: Traffic Control Devices Amendment 2010*.

Schedule 3, text after diagram **S3-2**: inserted, on 1 April 2011, by *clause 4.3(b) of Land Transport Rule: Traffic Control Devices Amendment 2010*.

Schedule 3, item **S3-3**: inserted, on 1 April 2011, by *clause 4.3(c) of Land Transport Rule: Traffic Control Devices Amendment 2010*.

Schedule 3, heading **S4-4 Two-column 4-aspect**: replaced, on 15 September 2005, by *clause 4.3(a) of Land Transport Rule: Traffic Control Devices Amendment 2005*.

Schedule 3, item **S4-5 Three column 5-aspect**: replaced, on 1 April 2011, by *clause 4.3(d) of Land Transport Rule: Traffic Control Devices Amendment 2010*.

Schedule 3, item **S4-5**: replaced, on 15 September 2005, by *clause 4.3(b) of Land Transport Rule: Traffic Control Devices Amendment 2005*.

Schedule 3, item **S4-6 Three column 6-aspect**: replaced, on 1 April 2011, by *clause 4.3(d) of Land Transport Rule: Traffic Control Devices Amendment 2010*.

Schedule 3, item **S4-6**: replaced, on 15 September 2005, by *clause 4.3(b)* of *Land Transport Rule: Traffic Control Devices Amendment 2005*.

Schedule 3, item **S4-8 Three column 8-aspect**: inserted, on 1 April 2011, by *clause 4.3(d)* of *Land Transport Rule: Traffic Control Devices Amendment 2010*.

Schedule 3, item **S4-10.1**: replaced, on 1 December 2016, by *clause 2.6* of *Land Transport Rule: Traffic Control Devices Amendment 2016*.

Schedule 3, item **S4-10.2**: replaced, on 1 December 2016, by *clause 2.6* of *Land Transport Rule: Traffic Control Devices Amendment 2016*.

Schedule 3, item **S4-10.3**: replaced, on 1 December 2016, by *clause 2.6* of *Land Transport Rule: Traffic Control Devices Amendment 2016*.

Schedule 3, item **S4-10.4A**: inserted, on 1 April 2011, by *clause 4.3(c)* of *Land Transport Rule: Traffic Control Devices Amendment 2010*.

Schedule 3, item **S4-10.4B**: inserted, on 1 April 2011, by *clause 4.3(e)* of *Land Transport Rule: Traffic Control Devices Amendment 2010*.

Schedule 3, text after **S4-10** series items: replaced, on 1 April 2011, by *clause 4.3(e)* of *Land Transport Rule: Traffic Control Devices Amendment 2010*.