

Evaluation of the C-roundabout – an improved multi-lane roundabout design for cyclists

December 2012

D Asmus, I Jurisich, TES Ltd, Auckland
D Campbell, Auckland Transport, Auckland
R Dunn, University of Auckland, Auckland

ISBN 978-0-478- 40707-5 (electronic)
ISSN 1173-3764 (electronic)

NZ Transport Agency
Private Bag 6995, Wellington 6141, New Zealand
Telephone 64 4 894 5400; facsimile 64 4 894 6100
research@nzta.govt.nz
www.nzta.govt.nz

Asmus, D, I Jurisich, D Campbell and R Dunn (2012) Evaluation of the C-roundabout – an improved multi-lane roundabout design for cyclists. *NZ Transport Agency research report 510*. 138pp.

This publication is copyright © NZ Transport Agency 2012. Material in it may be reproduced for personal or in-house use without formal permission or charge, provided suitable acknowledgement is made to this publication and the NZ Transport Agency as the source. Requests and enquiries about the reproduction of material in this publication for any other purpose should be made to the Research Programme Manager, Programmes, Funding and Assessment, National Office, NZ Transport Agency, Private Bag 6995, Wellington 6141.

Keywords: C-roundabout, cyclist, multi-lane roundabout, safety, New Zealand, NZ Transport Agency

An important note for the reader

The NZ Transport Agency is a Crown entity established under the Land Transport Management Act 2003. The objective of the Agency is to undertake its functions in a way that contributes to an affordable, integrated, safe, responsive and sustainable land transport system. Each year, the NZ Transport Agency funds innovative and relevant research that contributes to this objective.

The views expressed in research reports are the outcomes of the independent research, and should not be regarded as being the opinion or responsibility of the NZ Transport Agency. The material contained in the reports should not be construed in any way as policy adopted by the NZ Transport Agency or indeed any agency of the NZ Government. The reports may, however, be used by NZ Government agencies as a reference in the development of policy.

While research reports are believed to be correct at the time of their preparation, the NZ Transport Agency and agents involved in their preparation and publication do not accept any liability for use of the research. People using the research, whether directly or indirectly, should apply and rely on their own skill and judgement. They should not rely on the contents of the research reports in isolation from other sources of advice and information. If necessary, they should seek appropriate legal or other expert advice.

(22 April 2013 - Report amended to include the following information)

An important technical note specific to this report

Non-standard signs and markings, which do not comply with the Land Transport Rule: Traffic Control Devices (TCD Rule), have been used in undertaking this research.

These unauthorised signs and markings should not be replicated unless the appropriate approvals for such trial processes are obtained from the NZTA prior to using such non-complying devices on public roads. See NZTA Traffic Note 10 - Revision 3 - *Trials of traffic control devices - guidelines* - <http://www.nzta.govt.nz/resources/traffic-notes/docs/traffic-note-10-rev3.pdf>.

Acknowledgements

We acknowledge the assistance of the following people and groups:

- Team Traffic, for undertaking video surveys at the Palomino Dr/Sturges Rd roundabout
- Arvind Sima, Project Manager Auckland Transport, and Tim Hughes, National Traffic and Safety Engineer NZTA, for peer reviewing this research project
- Hussam Abdul-Rassol (previously Waitakere City Council) and Gareth Hughes (previously Rodney District Council) for cofunding this research project
- Cycle Action Auckland for their assistance in organising the cyclist surveys
- Winston Gee for his assistance in data collection.
- Steering group members: Gareth Hughes (Transport Safety Manager, previously Rodney District Council), Arvind Sima (Project Manager, Auckland Transport), Hussam Abdul-Rassol (Investigation and Design Manager for West Auckland, Auckland Transport), Tim Hughes (National Traffic and Safety Engineer NZTA), Bevan Woodward (Chairperson of Cycle Action Auckland).

Abbreviations and acronyms

CAS	Crash Analysis System
NZTA	NZ Transport Agency

Contents

- Executive summary..... 9**
- Abstract..... 12**
- 1 Introduction..... 13**
 - 1.1 Purpose of research 13
 - 1.2 Research background..... 13
 - 1.3 The C-roundabout design 13
 - 1.4 Where to use the C-roundabout design 15
 - 1.5 Scope and methodology of research 16
 - 1.5.1 Evaluation of the C-roundabout (Palomino Dr/Sturges Rd roundabout)..... 16
 - 1.5.2 Evaluation of a single-lane roundabout that was changed to have two narrow lanes (Margan Ave/Hutchinson Ave roundabout)..... 17
- 2 The new C-roundabout at Palomino Dr/ Sturges Rd..... 19**
 - 2.1 C-roundabout design at Palomino Dr/Sturges Rd 19
 - 2.1.1 Vehicle deflection through the roundabout 20
 - 2.1.2 Photos of the new C-roundabout 23
 - 2.2 Issues encountered in the construction of the C-roundabout 24
 - 2.2.1 Cars cutting across lanes through the roundabout 24
 - 2.2.2 Incorrect lane use by trucks and buses 27
 - 2.2.3 Conclusions re issues encountered in the construction of the C-roundabout 30
 - 2.3 Safety of the C-roundabout..... 30
 - 2.3.1 Introduction 30
 - 2.3.2 Literature review 30
 - 2.3.3 Vehicle speed survey 32
 - 2.3.4 Crash analysis 36
 - 2.3.5 Conflict analysis..... 40
 - 2.3.6 Summary regarding the safety of the C-roundabout 40
 - 2.3.7 Recommendations regarding the safety of the C-roundabout 41
 - 2.4 Capacity of the C-roundabout 41
 - 2.4.1 Introduction 41
 - 2.4.2 Lack of congestion at Palomino Dr/Sturges Rd roundabout 42
 - 2.4.3 SIDRA modelling 43
 - 2.4.4 On-site observation and measurements – regression analysis 45
 - 2.4.5 Delay measurements 48
 - 2.4.6 S-Paramics modelling..... 49
 - 2.4.7 Impact of trucks/buses on C-roundabout approaches 51
 - 2.4.8 Summary regarding the capacity of the C-roundabout..... 52
 - 2.4.9 Further research for assessing the capacity of the C-roundabout 53
 - 2.5 Road users’ impressions of the Palomino Dr/Sturges Rd C-roundabout 54
 - 2.5.1 Cyclist survey 54
 - 2.5.2 Pedestrian survey..... 61
 - 2.5.3 Car driver survey..... 66
 - 2.5.4 Local resident survey..... 74

2.5.5	Summary of the results of the surveys	82
2.5.6	Recommendations based on the survey results.....	83
3	Margan Ave/Hutchinson Ave roundabout (single lane changed to two narrow lanes)	84
3.1	Introduction.....	84
3.2	New design of Margan Ave/Hutchinson Ave roundabout	84
3.3	Safety of the Margan Ave/Hutchinson Ave roundabout	86
3.3.1	Crash analysis	86
3.3.2	Increase vehicle deflection to address safety concerns.....	90
3.3.3	Conclusions regarding the safety of the Margan Ave/Hutchinson Ave roundabout	91
3.3.4	Recommendations regarding the safety of the Margan Ave/Hutchinson Ave roundabout.....	91
3.4	Capacity of the Margan Ave/Hutchinson Ave roundabout.....	91
3.4.1	Conclusions regarding the capacity of Margan Ave/Hutchinson Ave roundabout....	92
4	Overall conclusions	93
4.1	The C-roundabout (Palomino Dr/Sturges Rd roundabout).....	93
4.1.1	Safety.....	93
4.1.2	Capacity.....	93
4.1.3	Road users' impressions of the C-roundabout (cyclists, pedestrians and car drivers).....	95
4.2	Single-lane roundabout changed to have two narrow lanes (Margan Ave/Hutchinson Ave roundabout).....	95
4.2.1	Safety.....	95
4.2.2	Capacity.....	95
5	Recommendations and further research.....	96
5.1	C-roundabout	96
5.1.1	Safety:.....	96
5.1.2	Capacity.....	96
5.1.3	Road users' impression of the C-roundabout	97
5.2	Single-lane roundabout changed to have two narrow lanes	97
6	References.....	98
Appendix A Speed survey for the Palomino Dr/ Sturges Rd roundabout.....		99
A.1	Speed survey.....	99
A.1.1	Methodology	99
A.1.2	Movement numbering	101
A.1.3	Movement distances	102
A.1.4	Sample size requirement.....	104
A.1.5	Summary of speed survey results	107
Appendix B Cyclist survey for the Palomino Dr/ Sturges Rd roundabout		110
Appendix C Pedestrian survey for the Palomino Dr/Sturges Rd roundabout.....		116
Appendix D Car driver survey for the Palomino Dr/Sturges Rd roundabout.....		120
Appendix E Preliminary guidelines for the C-roundabout.....		124
E.1	Design philosophy.....	124
E.2	General principles	124
E.3	Where to use the C-roundabout design	124
E.4	Roundabout entry width	126
E.5	Vehicle deflection through the roundabout.....	126

E.6	Tracking curves	126
E.7	Mountable areas for heavy traffic.....	126
E.8	Road marking and signage	126
E.9	Other design issues	127
E.9.1	Cyclist access to head of queues during congested periods	127
E.9.2	Service covers.....	127
E.9.3	Lighting	127
E.9.4	Sight distance.....	127
E.9.5	Roundabout approaches with two upstream traffic lanes	127
E.10	SIDRA modelling guidelines.....	128
E.11	Diagrams for the C-roundabout design	129
Appendix F Appendix references.....		138

Executive summary

The purpose of this research project was to evaluate the on-site operation of the C-roundabout design (at a site in Auckland, New Zealand). The C-roundabout (cyclist roundabout) is a new multi-lane roundabout design that was developed by D Campbell, I Jurisich and R Dunn as part of a 2006 Land Transport NZ research project titled *Improved multi-lane roundabout designs for cyclists*. The primary aim of the C-roundabout is to improve the safety of cyclists at multi-lane roundabouts and make multi-lane roundabouts more cyclist-friendly. The concept of the design is to decrease vehicle speeds through the roundabout to around 30 km/hr by increasing the deflection of the roundabout, and to reduce the widths of approach lanes and circulating lanes so that cyclists are required to travel in the centre of the lanes, like other vehicles. This research project was carried out from 2008 to 2011.

There were two parts to this research:

- evaluation of the C-roundabout (Palomino Dr/Sturges Rd)
- evaluation of a single-lane roundabout that had been changed to have two narrow lanes with no reduction in vehicle speeds (Margan Ave/Hutchinson Ave).

1 Evaluation of the C-roundabout (Palomino Dr/Sturges Rd roundabout)

The C-roundabout design was installed at the Palomino Dr/Sturges Rd roundabout in Auckland. The operation of the C-roundabout was evaluated in terms of its safety, capacity, and the opinions of cyclists, pedestrians and car drivers.

Safety

The C-roundabout was successful in achieving a lower-speed environment, with the 85th percentile through speeds being reduced to around 30km/hr. These vehicle speeds were close to the speed a cyclist would be travelling through the roundabout, which made it safer for cyclists. The chances of a cyclist surviving a crash decreases significantly above speeds of 20–30km/hr (Austroads 2009a). The lower speeds are also considered safer for other road users (pedestrians and motorists), and should result in less-severe crashes.

In the 2.5 years following the roundabout's reconstruction, there was no significant change in the crash rate. There were no cyclist crashes either before or after the reconstruction. There have been no injury crashes since the installation of the C-roundabout design; prior to the reconstruction there were 0.32 injury crashes/year. With the lower design speed we would expect the overall injury crash rate to drop. Further crash analysis in one to two years will provide enough data to conclusively assess the safety of the C-roundabout.

Capacity

The installation of the C-roundabout at this uncongested site (converting a standard multi-lane roundabout to a C-roundabout) had little impact on capacity (based on SIDRA and on-site measurements).

SIDRA modelling indicates that for an uncongested roundabout, conversion to a C-roundabout has very little impact on the average delay (7.5sec/veh before, 8.1sec/veh after), the degree of saturation (0.579 before, 0.568 after) and the design life (12 years before, 12 years after). However, SIDRA calculates a small increase in the critical gap and follow-up headway due to the geometry of the C-roundabout (decreased negotiation speed through the roundabout, narrow approach lane width, and increased roundabout diameter). This could not be confirmed by on-site measurements (gap and follow-up headway) because of insufficient congested periods (total of 13 minutes congested periods in both peak periods).

Delays measurements indicated that converting the multi-lane roundabout to a C-roundabout had no significant impact on the delays.

Regression analysis suggested a drop in capacity for the C-roundabout design when the circulating flows were less than 878veh/hr and an increase in capacity when circulating flows were greater than 878veh/hr. However, as the roundabout had so little congestion there was insufficient survey site data to statistically conclude whether or not this was the case. Further research would be required at more congested sites to confirm this.

The capacity of the Palomino Dr/Sturges Rd C-roundabout was not impacted by trucks/buses as the numbers were very low. Trucks/buses may impact on C-roundabout approach capacity as they are required to straddle both lanes (thus blocking access to one lane)¹. However, this impact is unlikely to be significant, as heavy-vehicle numbers are usually low in peak periods. The amount of impact that trucks/buses have on the capacity of a C-roundabout is expected to depend on the following factors:

- Queues and lane utilisation on the approach – the greater the difference between approach lane queue lengths, the greater the impact of trucks/buses on the capacity of the approach. Further research is recommended to confirm this.
- Proportion of trucks/buses – the higher the proportion of trucks/buses, the more likely they negatively impact on the capacity of the approach.

The capacity implications of converting an existing multi-lane roundabout into a C-roundabout were difficult to assess at the Palomino Dr/Sturges Rd site because of the low traffic flows, very little queuing and stop-line delay, and very few congested periods (only 13 minutes in both peak periods).

Road users' impressions of the C-roundabout (cyclists, pedestrians and car drivers)

The C-roundabout design at the Palomino Dr/Sturges Rd intersection drew positive feedback from cyclists and pedestrians, but a less positive reaction from the car drivers – about half were not in favour of it.

- Cyclists were positive about the C-roundabout and would like to see more of them installed. They found it easier to use, safer, and better for cyclists. They also noticed that car speeds were slower.
- Pedestrians were positive about it and in general found it safe and better for pedestrians. They found it easy to cross, and noticed that the crossing distance was narrower and that car speeds were slower.
- Car drivers noticed that car speeds were slower and the lanes were narrower (the intention of the C-roundabout design), but about half of them did not like the C-roundabout and did not want to see more of them installed. About half the drivers found the C-roundabout more difficult to use and indicated a preference for a standard roundabout.

More than half of the drivers thought that the C-roundabout was 'safe' or 'the same as other roundabouts', but a significant proportion (41%) thought it was unsafe. The results of the crash analysis did not confirm this perception of the C-roundabout being unsafe, and as vehicle speeds had dropped, it was unlikely to be less safe.

The majority of the drivers thought that the roundabout was actually less safe for cyclists, and were unable to recognise the benefits of the C-roundabout for cyclists.

¹ Non-standard signs and markings, which do not comply with the Land Transport Rule: Traffic Control Devices (TCD Rule), have been used in undertaking this research. Refer to page 3 of this report.

The drivers' impression of the roundabout may improve if they are informed of the benefits of the C-roundabout for cyclists and of the cyclists' support for the C-roundabout. Also, their impression may improve over time as they become accustomed to using the tight, slower roundabout. Further monitoring of car drivers' impressions of the C-roundabout should be undertaken.

2 Evaluation of single-lane roundabout changed to have two narrow lanes (Margan Ave/Hutchinson Ave roundabout)

This site involved changing two approaches from wide, single lanes to two narrow lanes, without altering the kerbs. The intention of studying this site was to assess whether or not it would be possible to fit a small double-lane roundabout within the same road reserve as a single-lane roundabout, thus improving the capacity at low cost.

It should be noted that the reconstruction of the Margan Avenue/Hutchinson Avenue roundabout did not comply with all of the C-roundabout design principles as it did not involve increasing the vehicle deflection to slow vehicle speeds through the roundabout to around 30km/hr (the design speed for the roundabout was approximately 50km/hr). Thus, the differential speed between vehicles and cyclists was not expected to decrease – ie cyclist safety was not specifically being addressed at this site.

The evaluation showed that the capacity of a single-lane roundabout can be improved (almost doubled, depending on the lane utilisation of two-lane approaches) at a very low cost by converting to the two narrow lanes design.

The crash analysis of the Margan Ave/Hutchinson Ave roundabout showed that the safety of the roundabout decreased after it was changed from a single-lane roundabout. The overall crash rate increased significantly and the injury crash rate also increased. It may not be advisable to install narrow double-lane roundabouts without decreased vehicle speeds at other sites until the safety concerns have been addressed or confirmed at this trial site. To improve the safety of this roundabout, it is recommended that the vehicles speeds should be decreased to around 30km/hr by increasing the vehicle deflection. The safety of the roundabout should be reassessed one year following the above changes to determine whether the increased vehicle deflection has addressed the safety concerns. If the increased vehicle deflection is successful in reducing the crash rate, then it will prove the principle of the C-roundabout – that roundabout speeds should be reduced for safety.

Recommendations

- The principles applied to the C-roundabouts in order to reduce approach and circulating speeds should be considered in other locations where a more cyclist-friendly layout is desirable – ie where cyclists form a significant proportion of the local network traffic. However, it is important to note that an important contribution to the safe and efficient operation of a roundabout is that of a similar treatment on all approach legs, producing a well-balanced intersection. Further research into the key features of the C-roundabout design should be undertaken.
- Single-lane roundabouts can be converted to narrow two-lane roundabouts for capacity reasons at low cost compared with that of the standard design. Further research on the safety implication of this conversion is needed.

Abstract

The C-roundabout (cyclist roundabout) is a new multi-lane roundabout design (developed as part of a 2006 Land Transport NZ research project *Improved multi-lane roundabout designs for cyclists*) that aims to improve the safety of cyclists at multi-lane roundabouts and make multi-lane roundabouts more cyclist-friendly.

A C-roundabout was installed at the Palomino Dr/Sturges Rd intersection in Auckland and was evaluated between 2008 and 2011 in terms of its safety, capacity, and the opinions of cyclists, pedestrians and car drivers.

The C-roundabout successfully reduced vehicle speeds to 30km/hr, which is close to the speed of cyclists. This made the roundabout safer for cyclists, as well as for other road users. The installation of the C-roundabout at this uncongested site had little impact on capacity. It drew positive feedback from cyclists and pedestrians, but about half of the car drivers were not in favour of it. This could be expected as they may prefer a wider roundabout than the narrow C-roundabout.

Another site (Margan Ave/Hutchinson Ave) was also reviewed and involved changing two approaches from wide single lanes to two narrow lanes, without altering the kerbs and with no reduction in design speed. The evaluation showed the capacity of a single-lane roundabout can be improved (almost doubled) at very low cost. However, the safety of the roundabout had decreased and a reduction in design speed was recommended to address this.

1 Introduction

1.1 Purpose of research

The purpose of this research was to evaluate the on-site operation of the C-roundabout design (at a site in Auckland, New Zealand). The C-roundabout (cyclist roundabout) is a new multi-lane roundabout design developed by D Campbell, I Jurisich and R Dunn as part of a Land Transport NZ² research project titled *Improved multi-lane roundabout designs for cyclists* (Campbell et al 2006).

The primary aim of the C-roundabout is to improve the safety of cyclists at multi-lane roundabouts and make the multi-lane roundabouts more cyclist-friendly. The concept of the design is to decrease vehicle speeds through the roundabout (to around 30km/hr) by increasing the deflection of the roundabout and making the roundabout tight (ie traffic-calmed). This should result in a decrease in the speed differential between cyclists and vehicles, and as a result improve the roundabout's safety for cyclists. In this design, cyclists are not provided with a separate facility, but instead the widths of the approach and circulating lanes are narrowed so that cyclists can ride in the centre of the lanes, reducing the risk of drivers attempting to overtake them. Previous research had found that this was the most desirable solution for cyclists with some level of riding experience (Campbell et al 2006).

Previous research also indicated that 68% of cyclist crashes at multi-lane roundabouts in Auckland occurred at the entrance to the roundabout, involving an entering vehicle and a circulating cyclist, and a literature review in that study confirmed this was similar to overseas findings. It is intended that the tight geometric design of the C-roundabout will slow down vehicle entry speeds to address these crashes. The chances of a cyclist surviving a crash decreases significantly above speeds of 20–30km/hr (Austroads 2009a). The reduced speed should also result in improved safety for other road users, such as pedestrians and motorists.

The research project focused on the safety and capacity of the C-roundabout, and the views of cyclists, pedestrians and car drivers regarding the C-roundabout. This research project was carried out from 2008 to 2011.

1.2 Research background

Multi-lane roundabouts are typically viewed by cyclists as one of the most hazardous types of intersections to negotiate. Police crash statistics confirm this to be the case. In 2003, scheme design investigators in Auckland discovered that there was no adequate on-road design available that would enable cyclists to ride through multi-lane roundabouts, which seemed to be a deficiency in design standards. In 2005, Campbell et al (2006) developed an on-road design solution named the C-roundabout, and this current research project aimed to test its effectiveness.

1.3 The C-roundabout design

As mentioned above, the principle of the C-roundabout is for through car speeds (unimpeded) to be reduced to around 30km/hr, a speed considered to be amenable to cyclists mixing with vehicle traffic. At this speed the vulnerable cyclists' chances of having a serious crash or dying from a collision is minimal.

² Now NZ Transport Agency – NZTA.

The geometric layout is critical to this aim, requiring the C-roundabout to have narrow entry and circulating carriageway widths.

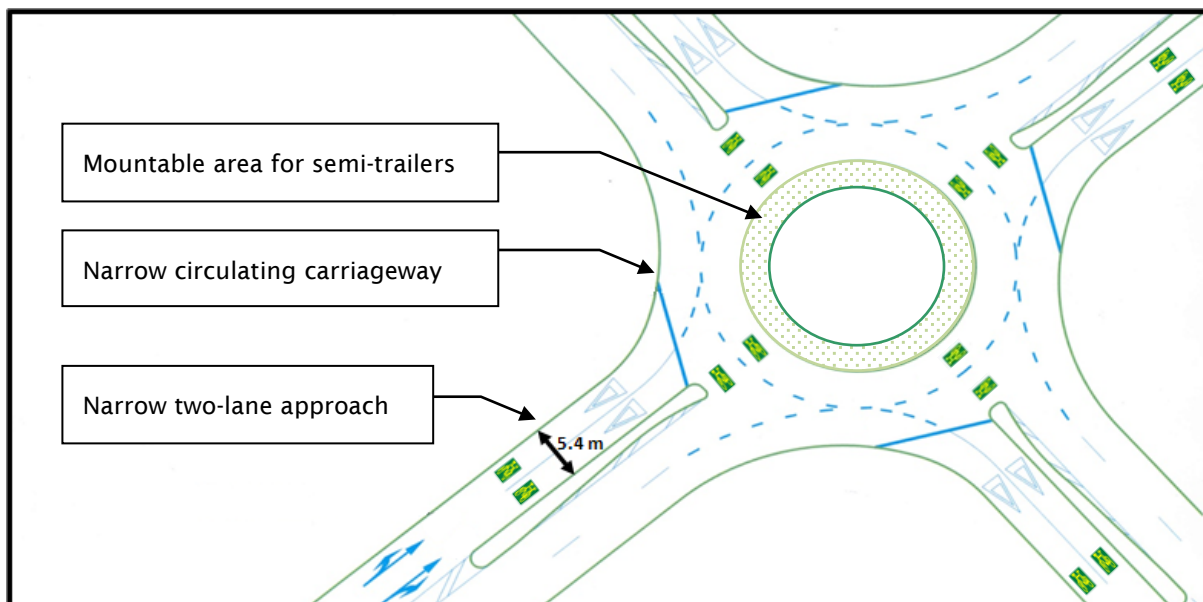
The C-roundabout allows two 99 percentile cars to travel alongside each other through the roundabout, with 0.5m clearances. For large vehicles (buses and large trucks), the roundabout design allows them to manoeuvre through the roundabout using both of the lanes and any mountable areas – it is expected that large vehicles will use (straddle) both lanes on the approaches and also through the roundabout. In some cases where extra width may be required, mountable areas can be provided, eg to be used by a semi-trailer. For the comfort of bus passengers, the circulating carriageway width should be sufficient to accommodate bus manoeuvres so they don't have to use the mountable area.

The key features of the C-roundabout design are as follows:

- two-lane configuration (ie multi-lane roundabout)
- geometric layout such that unimpeded vehicle through speed is around 30km/hr (maximum path radius of 30–40m is required to achieve this)
- narrow entry width – approximately 5.4m, kerb-to-kerb (ie 2.7m lane widths)
- narrow circulating carriageway width – allows for two 99%-sized cars to travel side by side with a minimum of 0.5m clearance between cars and kerbs
- large vehicles required to straddle lanes on the approach and through the roundabout
- buses required to straddle lanes, but not use mountable area.

Refer to figure 1.1 for an illustration of the C-roundabout design. For further details of the design of the C-roundabout refer to *Improved multi-lane roundabout designs for cyclists* (Campbell et al 2006).

Figure 1.1 C-roundabout generic design prepared for a typical four-way cross intersection

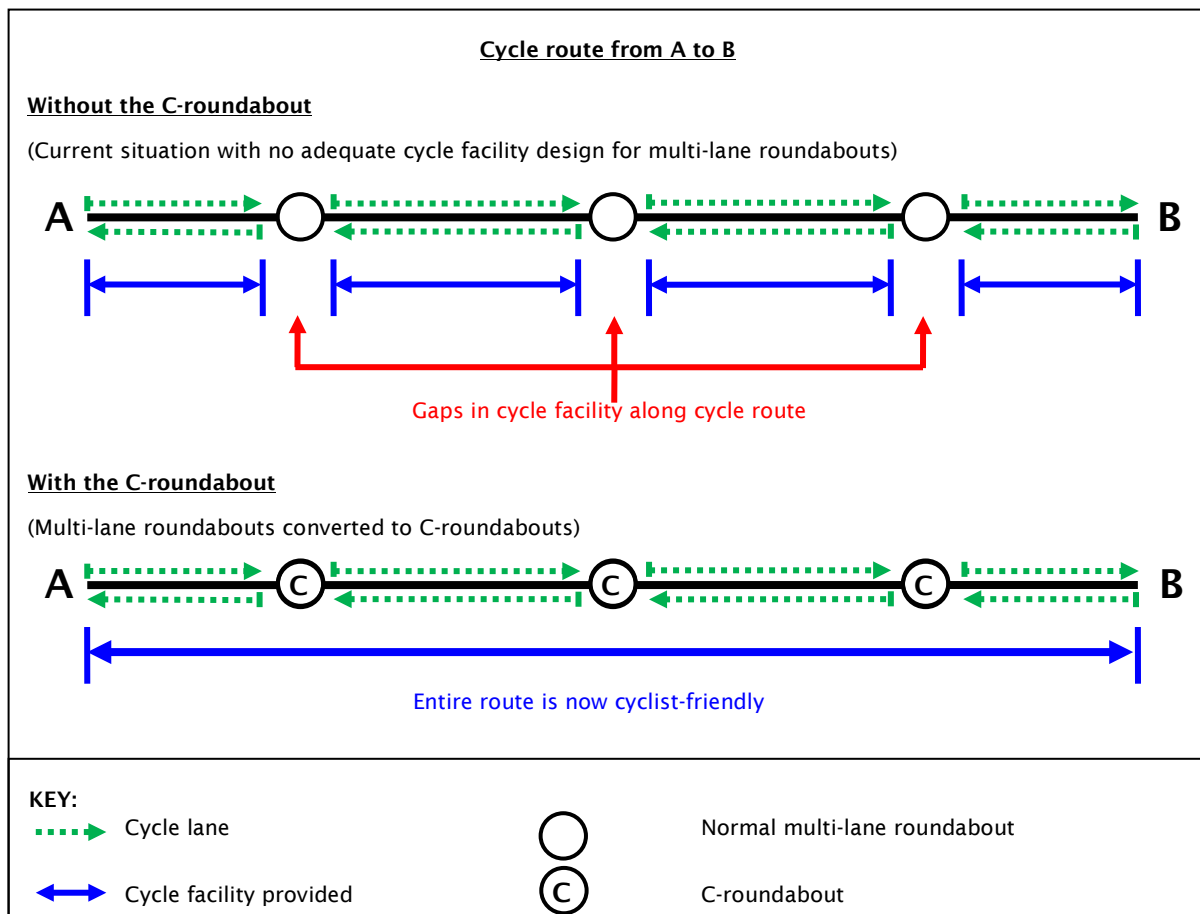


1.4 Where to use the C-roundabout design

The C-roundabout is designed to be installed on cycle routes. As there are currently no adequate cyclist-friendly design solutions for multi-lane roundabouts, cycle facilities typically stop prior to any multi-lane roundabouts on cycle routes. Cyclists are then left to negotiate the multi-lane roundabouts on their own without any improvements to the roundabouts. This results in gaps in the cycle facilities provided on the cycle route. With the use of the C-roundabout design, multi-lane roundabouts can be converted and provide cycle facilities for the entire cycle route (see figure 1.2 for an illustration of this).

Austrroads (2009b) suggests that cycle lanes could be provided through the multi-lane roundabouts. However, this is not considered to be favourable, according to the literature review done as a part of the *Improved multi-lane roundabout designs for cyclists* report (Campbell et al 2006).

Figure 1.2 Cycle route with and without C-roundabouts



Other possible applications of the C-roundabout design include the following:

- At an existing multi-lane roundabout where there are a large number of cyclist crashes or a need to improve cyclist safety, the multi-lane roundabout could be converted to a C-roundabout.
- At a site where an existing single-lane roundabout is to be converted to a multi-lane roundabout for improved capacity, but there are concerns for the safety of cyclists, a C-roundabout could be installed

instead to provide a more cyclist-friendly alternative. The cost of the C-roundabout is likely to be lower than that of a standard multi-lane roundabout, as the kerbs may not need to be altered.

- At a site where a priority intersection is to be converted to a multi-lane roundabout for improved capacity, but there are concerns for the safety of cyclists, a C-roundabout could be installed instead to provide a more cyclist-friendly alternative.
- At a site where a signalised intersection has a crash problem and a multi-lane roundabout is being considered, installation of a C-roundabout could not only provide a more cyclist-friendly option but also a low-speed option that reduces the severity of crashes (with speeds of around 30km/hr there are unlikely to be fatal crashes).
- At a single-lane roundabout where there are cyclist crashes or a need to improve cyclist safety, the C-roundabout concept of increasing vehicle deflection to reduce vehicle speeds could be applied to all the roundabout approaches – ie apply the principle of the C-roundabout design to a single-lane roundabout.

1.5 Scope and methodology of research

1.5.1 Evaluation of the C-roundabout (Palomino Dr/Sturges Rd roundabout)

To evaluate the on-site operation of the C-roundabout, the Palomino Dr/Sturges Rd roundabout (Western Heights, Auckland) was studied.

This site was changed from a multi-lane roundabout to a C-roundabout. The changes made to this roundabout were as follows:

- Two approaches (northern and southern) were converted from the conventional two-lane approach configuration to the C-roundabout configuration with two narrow approach lanes (kerb-to-kerb width of 5.4m).
- Vehicle deflection through the roundabout was increased to reduce vehicle speeds to about 30km/hr.

Refer to section 2.1 for a description of the C-roundabout design at this site.

The operation of the C-roundabout was evaluated in terms of its safety performance and operational capacity performance, and from surveys of cyclist, pedestrian and vehicle driver opinions of it.

1.5.1.1 Safety of the C-roundabout for all road-users

To assess the safety performance of the C-roundabout, the operation of the Palomino Dr/Sturges Rd site was reviewed as follows:

- *Literature review:* A brief review of articles relating to safety at roundabouts in relation to geometry and other factors was undertaken.
- *Vehicle speed survey:* Because the reduction of through vehicle speeds is one of the main objectives of the C-roundabout design, to improve cyclist safety at multi-lane roundabouts, a 'before' and 'after' vehicle speed survey was undertaken at Palomino Dr/Sturges Rd roundabout to assess the extent to which speeds were altered.
- *Crash history analysis:* The crash history at the roundabout for before and after it was converted to the C-roundabout configuration was compared.
- *Conflict analysis:* A brief conflict analysis was undertaken during the AM peak period for before and after the roundabout was converted to the C-roundabout configuration.

1.5.1.2 Capacity of the C-roundabout

To assess the capacity performance of the C-roundabout, the operation of the Palomino Dr/Sturges Rd roundabout was assessed to see if there was any difference in capacity between a conventional multi-lane roundabout and the C-roundabout.

The following tasks were undertaken:

- *SIDRA modelling*: SIDRA models for the roundabout, before and after it was converted to the C-roundabout configuration, were developed.
- *On-site observation and measurements*: The operational capacity of the roundabout was reviewed using the video footage for the peak periods. The entry and circulating flow for the northern approach were measured during congested periods. The delays for before and after the roundabout was converted to a C-roundabout were measured per lane.
- *S-Paramics modelling*: An S-Paramics model for the Palomino Dr/Sturges Rd roundabout with its C-roundabout configuration was developed.

1.5.1.3 Cyclist, pedestrian and driver opinion of the C-roundabout

The following surveys were undertaken to assess road users' impressions of the C-roundabout:

- cyclist survey (total survey response was 14)
- pedestrian survey (total survey response was 23)
- driver survey (total survey response was 104)
- resident survey (total survey response was 6).

1.5.1.4 Revised preliminary guideline for the C-roundabout

In 2005 a preliminary guideline for the C-roundabout was prepared as part of the original Land Transport NZ project. Following the evaluation of the on-site operation of the C-roundabout design at the Palomino Dr/Sturges Rd trial site, the guidelines were updated. Preliminary guidelines for the SIDRA modelling of the C-roundabout have also been provided. Refer to appendix E for the preliminary guidelines.

1.5.2 Evaluation of a single-lane roundabout that was changed to have two narrow lanes (Margan Ave/Hutchinson Ave roundabout)

A second site, the Margan Ave/Hutchinson Ave roundabout (New Lynn, Auckland), was also reviewed as part of this research project.

At this roundabout two of the approaches were changed from a wide single lane to two narrow lanes, without altering the kerb lines (refer to section 3.2 and figure 3.1 for further description of changes made at this site). The intention of studying this site was to assess whether or not it would be possible to fit a small double-lane roundabout within the same road reserve as a standard single-lane roundabout, thus improving the capacity at low cost. No changes to the vehicle deflection (100m radius and greater) were undertaken, so the vehicle speeds (design speed of 50km/hr and greater) were not expected to be significantly affected.

It should be noted that the reconstruction of the Margan Ave/Hutchinson Ave roundabout did not comply with the principles of the C-roundabout design, as it did not involve increasing the vehicle deflection to slow vehicle speeds through the roundabout to around 30km/hr. Thus, the differential speed between vehicles and cyclists were not expected to decrease – ie, cyclist safety was not specifically being addressed at this site and the roundabout was not being made cyclist-friendly.

The operation of the Margan Ave/Hutchinson Ave roundabout, with the narrow two lanes, was evaluated in terms of its safety and capacity performance, as follows:

1.5.2.1 Safety performance of the Margan Ave/Hutchinson Ave roundabout

To assess the safety performance, the crash history at the roundabout for before and after it was converted from single lane to two narrow lanes was compared. The objective was to assess the safety implications of converting single-lane roundabouts to narrow two-lane roundabouts, with no changes to the design speed.

1.5.2.2 Capacity performance of the Margan Ave/Hutchinson Ave roundabout

The primary objective of changing the Margan Ave/Hutchinson Ave roundabout from single lane to two narrow lanes was to improve the capacity at a low cost. To assess the capacity performance of the roundabout, video footage of the roundabout before and after it was altered was reviewed.

2 The new C-roundabout at Palomino Dr/ Sturges Rd

2.1 C-roundabout design at Palomino Dr/Sturges Rd

The main focus of this research project was the conversion of the Palomino Dr/Sturges Rd roundabout to a C-roundabout, and the subsequent before and after study of this site.

The changes made to this roundabout were as follows (refer to figure 2.2 for an illustration of the modifications):

- Two approaches (northern and southern) were converted from the conventional two-lane approach configuration to the C-roundabout configuration of two narrow approach lanes (kerb-to-kerb width of 5.4m). The other two approaches were not changed to the C-roundabout configuration, as they were single-lane approaches, although their speeds were reduced.
- Vehicle deflection through the roundabout was increased to reduce vehicle speed to about 30km/hr. The central island and splitter islands were modified to increase the deflection and hence reduce the vehicle through speeds for all approaches. The outer kerb lines were not altered. The vehicle deflection for the northern and southern approaches was increased to have radii of 40m, which complies with the C-roundabout design principles. Refer to the next section for the vehicle deflection description.

The reconstruction of the roundabout began in April 2009. Following this, modifications to the road marking and signage were undertaken to further improve its safety and operation.

Aerial photos of the roundabout before and after the reconstruction are shown in figure 2.1. Photos of the new Palomino Dr/Sturges Rd C-roundabout are included in section 2.1.2.

Figure 2.1 Aerial photos for the Palomino Dr/Sturges Rd roundabout prior to reconstruction, and after new C-roundabout configuration installed in 2009

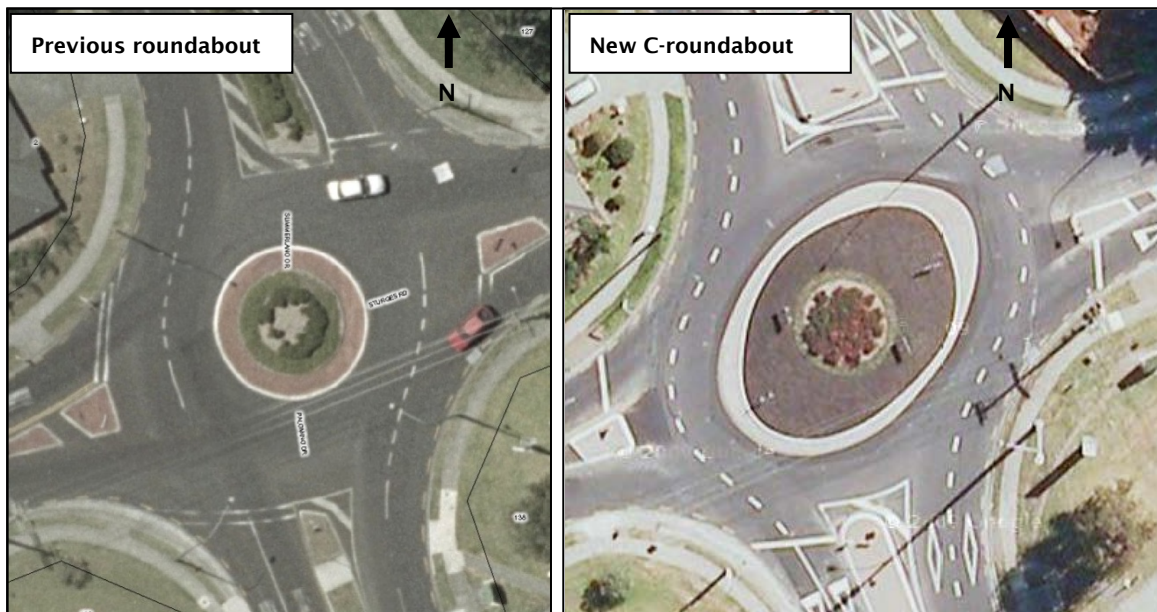
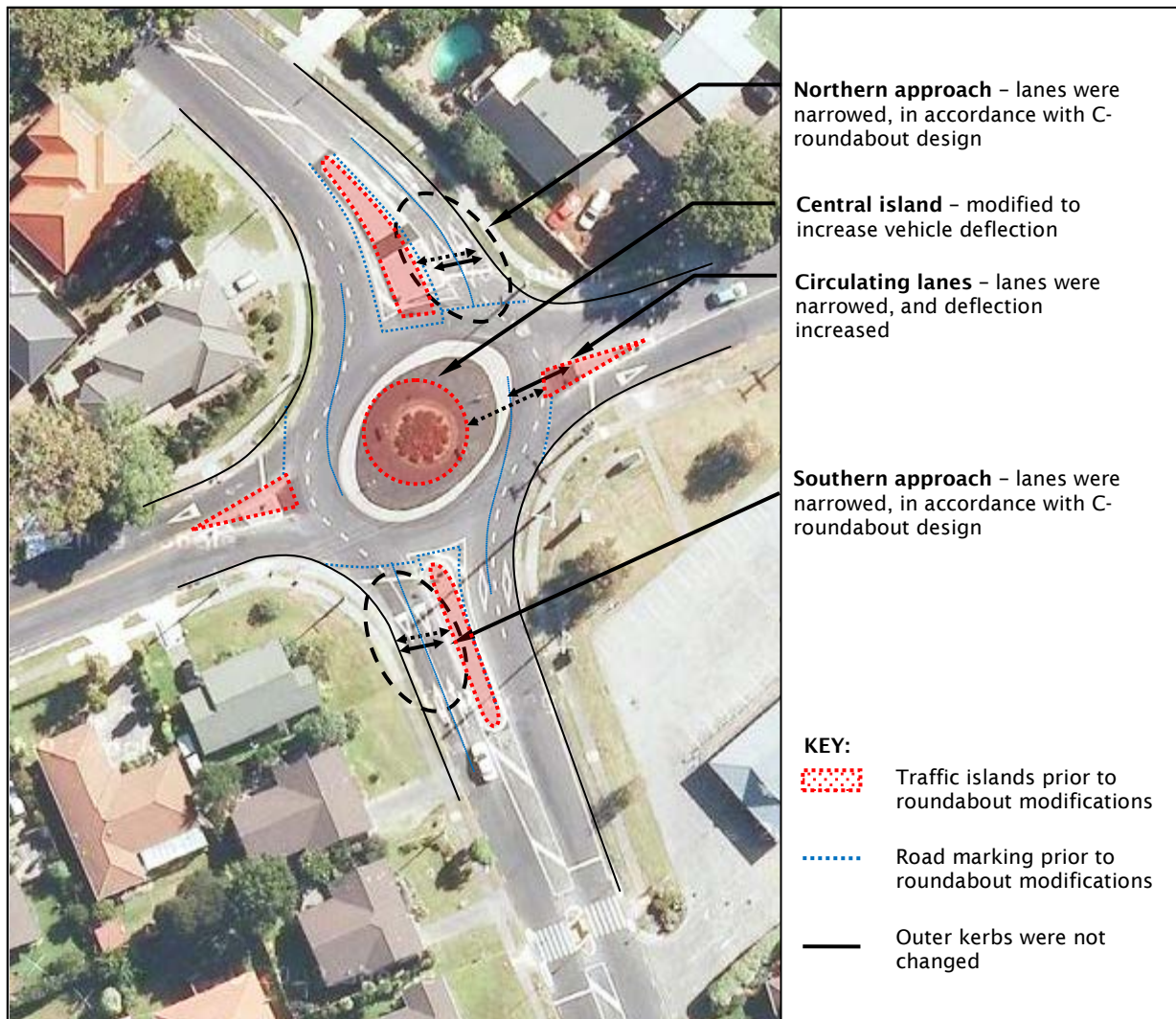


Figure 2.2 Illustration of modifications made to Palomino Dr/Sturges Rd roundabout to convert it to the C-roundabout design



2.1.1 Vehicle deflection through the roundabout

A key feature of the C-roundabout design is to reduce vehicle through speeds to around 30km/hr by increasing deflection through the roundabout. The deflection is increased by reducing the maximum path radius through the roundabout – this is the maximum radius a car can travel through the roundabout between the kerbs, and relates to the expected unimpeded vehicle through speeds. From the research undertaken in the *Improved multi-lane roundabout designs for cyclists* project (Campbell et al 2006), it was concluded that radii up to 40m may be acceptable, but beyond this the speed differential between cyclists and unimpeded car traffic would be undesirably high.

At the Palomino Dr/Sturges Rd roundabout, the maximum through-path radii were reduced from the original radii (which ranged from 80–100m) to 40–50m. The northern and southern approaches were changed to have radii of 40m, which complies with the C-roundabout design principles. As a result the 85th percentile unimpeded vehicle through speed was expected to reduce from 45–49km/hr to 32km/hr for the northern and southern approaches, and to reduce from 50km/hr to 36km/hr for the eastern and

western approaches, based on the relationship between the speed and path radius given in Austroads (1993) (see figures 2.3 and 2.4).

Figure 2.3 Maximum path radii and expected unimpeded speeds for Palomino Dr/Sturges Rd roundabout before reconstruction

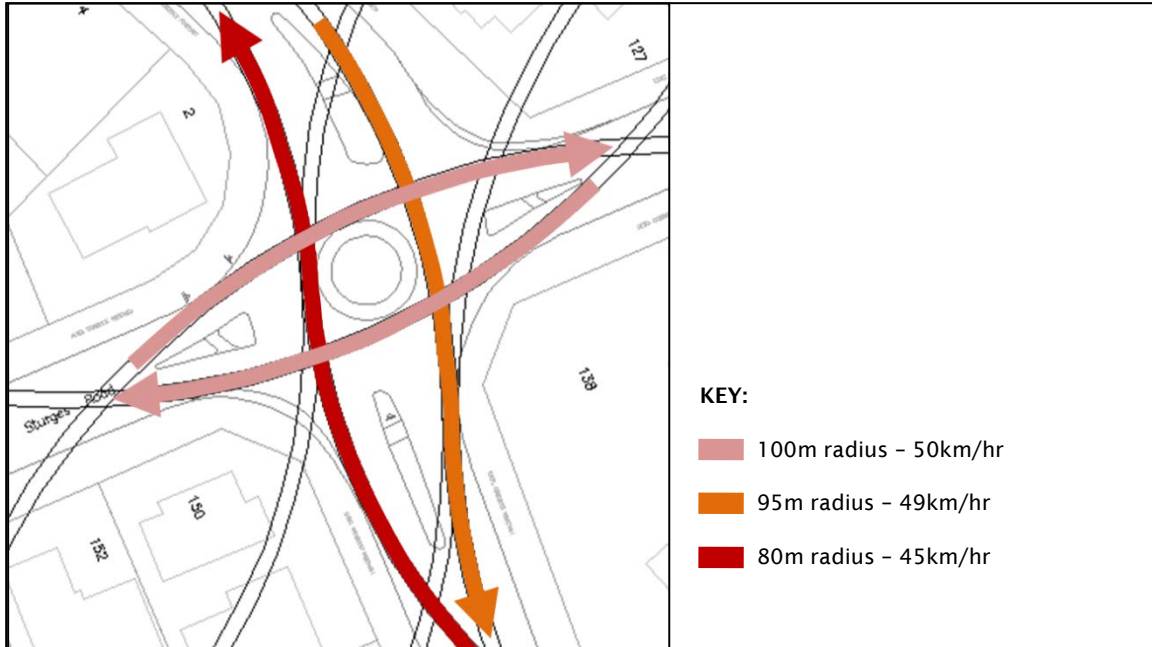
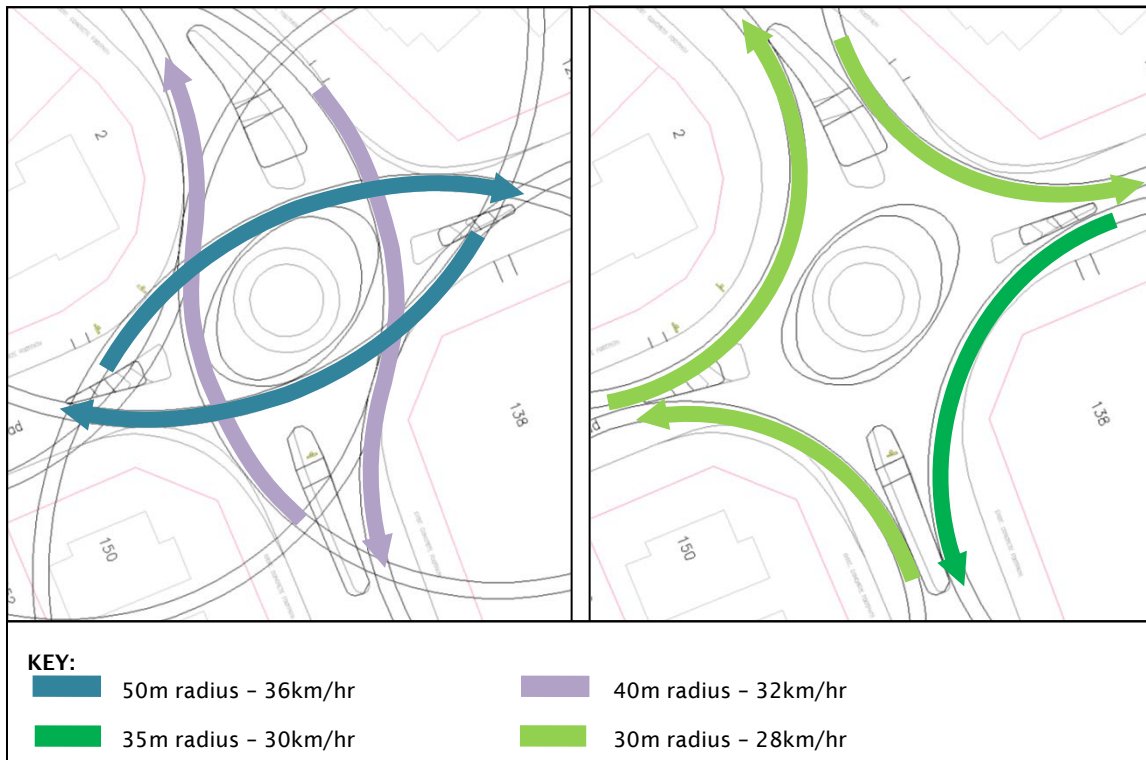
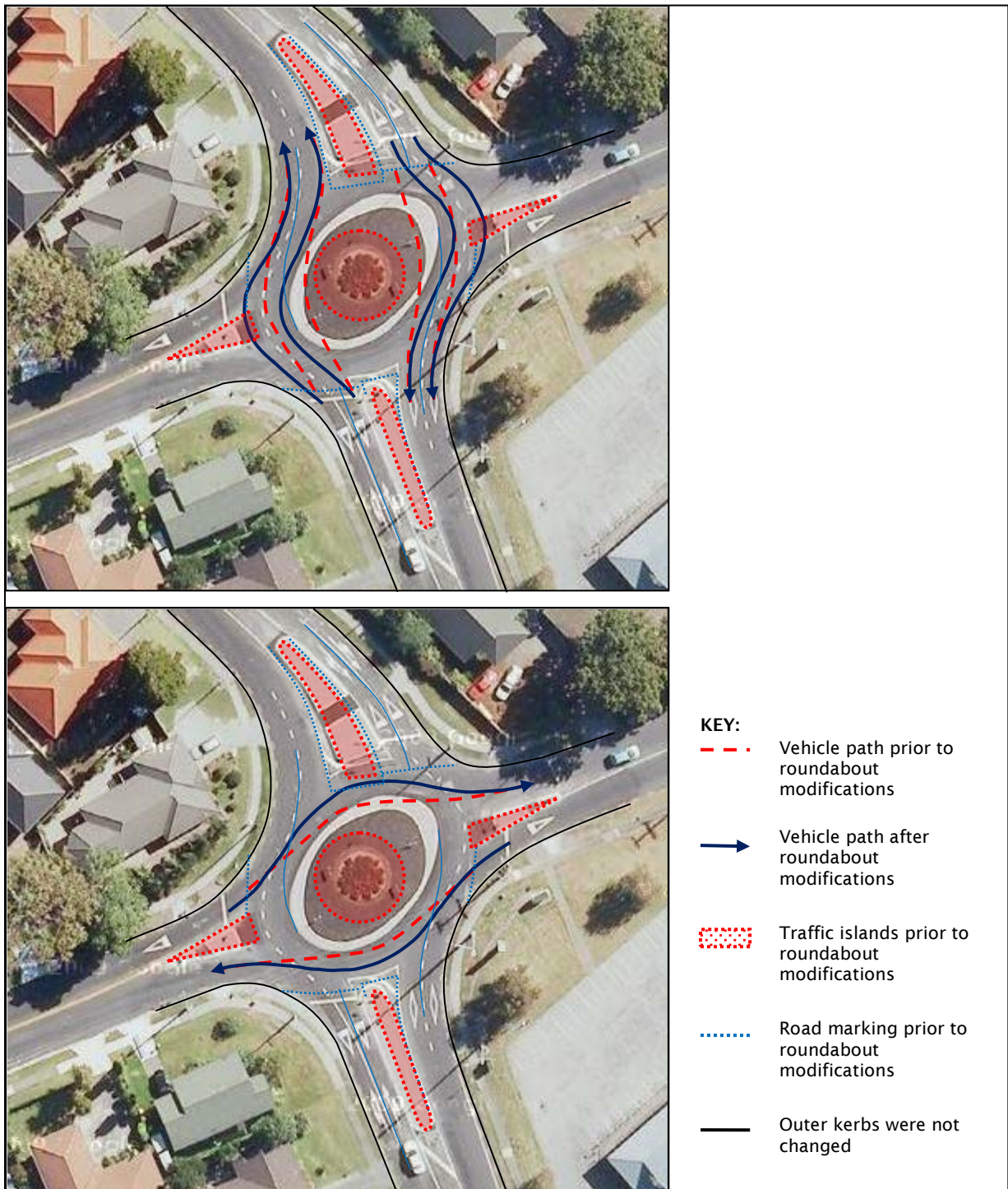


Figure 2.4 Maximum path radii and expected unimpeded speeds for Palomino Dr/Sturges Rd roundabout following reconstruction to C-roundabout design



It can be seen that typical vehicle tracking has changed significantly, as illustrated in figure 2.5.

Figure 2.5 Typical path of vehicles before and after Palomino Dr/Sturges Rd reconstruction



2.1.2 Photos of the new C-roundabout

The following photos illustrate the design of the new C-roundabout installed at Palomino Dr/Sturges Rd intersection, as well as the new signs and road markings.

Figure 2.6 Palomino Dr/Sturges Rd C-roundabout (prior to cycle symbol road marking)



Figure 2.7 Palomino Dr/Sturges Rd C-roundabout, north approach with truck lane-use sign and cycle symbol road marking³



Figure 2.8 Palomino Dr/Sturges Rd C-roundabout, cycle symbol road marking on circulating lanes in roundabout



³ Non-standard signs and markings, which do not comply with the Land Transport Rule: Traffic Control Devices (TCD Rule), have been used in undertaking this research. Refer to page 3 of this report.

Figure 2.9 Roundabout sign with 30km/hr advisory speed sign, installed on approaches to the C-roundabout



2.2 Issues encountered in the construction of the C-roundabout

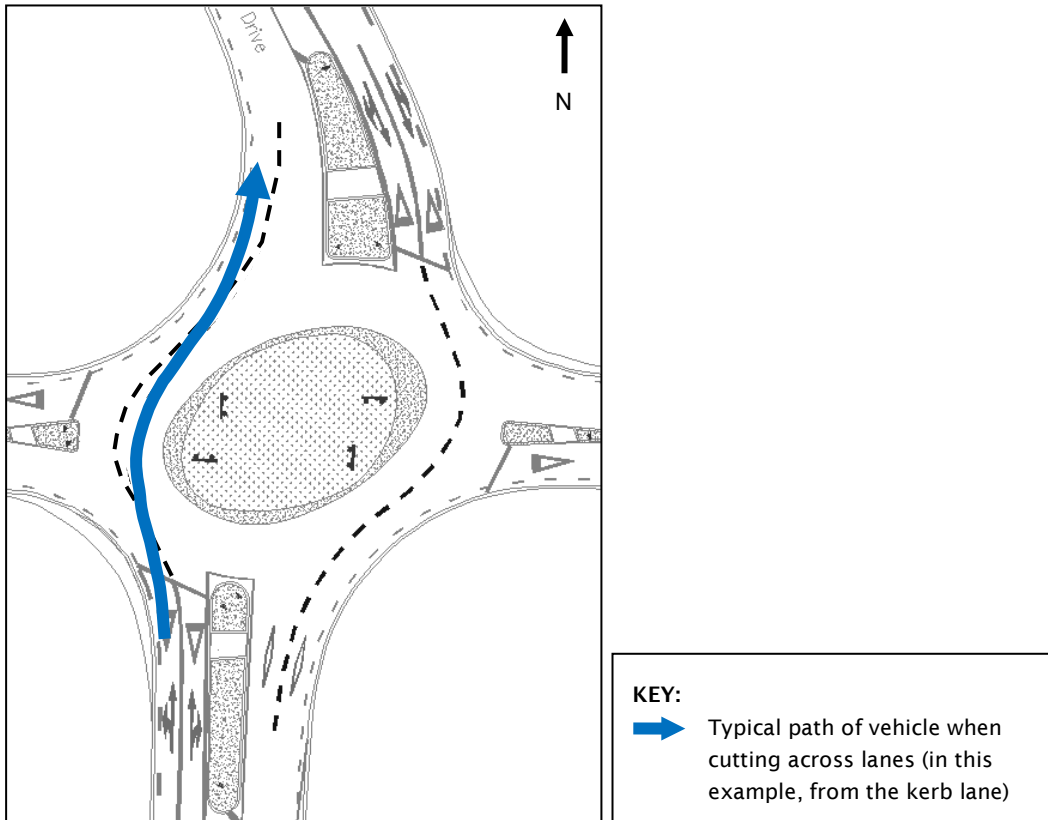
The following two issues were encountered when constructing the Palomino Dr/Sturges Rd C-roundabout:

- 1 Cars cutting across lanes through the roundabout – 73% of cars in the kerb lane tended to cut across into the inner lane when travelling through the roundabout. After this issue was addressed, 59% of cars cut across into the inner lane, which was a 14% improvement.
- 2 Incorrect lane use by trucks and buses – 73% of trucks/buses tried to fit into one lane instead of straddling both lanes on the approach to the roundabout. After this issue was addressed, 53% of trucks/buses failed to straddle both lanes, which was a 20% improvement.

2.2.1 Cars cutting across lanes through the roundabout

When the C-roundabout was first installed, the circulating lane lines were incorrectly marked out. This resulted in vehicles cutting across lanes through the roundabout, which raised safety concerns. Also, a number of residents expressed their concern to the local council, so it was perceived by drivers to be a problem. Figure 2.10 shows the typical path of vehicles that were cutting across the lanes through the roundabout. Video surveys indicated that 73% of the vehicles in the kerb lane cut across the lane line into the inner lane when travelling northbound from Palomino Dr to Summerland Dr.

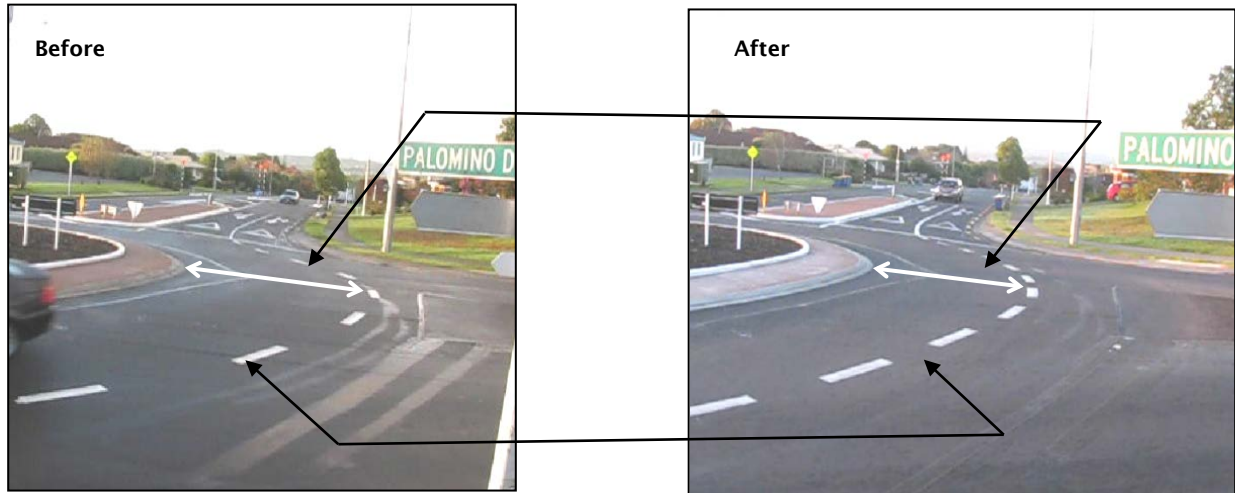
Figure 2.10 Illustration of typical vehicle path when cutting across the lanes through the roundabout



The lane guidelines were stripped and remarked in the correct location. Also, to help ensure that vehicles did not continue to cut across the lanes, the circulating lane lines were made 200mm thick and at closer spacing of 1:1 (1 m length, 1 m gap). Refer to figure 2.11 for an illustration of the changes made.

Figure 2.11 Photos illustrating correction to lane guidelines

Top arrows: The guidelines through the roundabout were re-marked. They were originally marked incorrectly with the centre lane marked too wide, which meant that kerb lane cars had to swing far to the right (from view of photo) to stay in their lane. In the 'after' photo it is shown that the new guidelines were re-marked closer to the centre island.



Bottom arrows: The width of guidelines was increased and spacing was decreased to discourage drivers from cutting across lanes.

Once the set-out of the circulating lane lines was corrected and they were marked thicker and at closer spacing, the behaviour of cars within the lanes improved. Another video survey was carried out after the improvements to determine the change in the lane use for vehicles travelling northbound from the southern approach (Palomino Dr to Summerland Dr). Following the improvements, the video survey showed that 59% of the vehicles in the kerb lane cut across the lane lines when travelling through the roundabout, which was a 14% improvement.

This highlighted the importance of setting out the lane guidelines correctly on-site. As the lanes on the C-roundabout are narrow, it is more important to mark thick lane guidelines at close intervals, to emphasise that vehicles should stay in their own lanes, thus reducing the risk of sideswipe crashes. Also, to keep speeds down in the conflict area, the size of the advisory speed sign installed below the roundabout sign (refer to figure 2.12) should be increased to 750mm, which could also assist in reducing the risk of sideswipe crashes. Survey indicated that a low percentage (35%) of driver noticed the existing 650mm sign (refer to section 2.5.3).

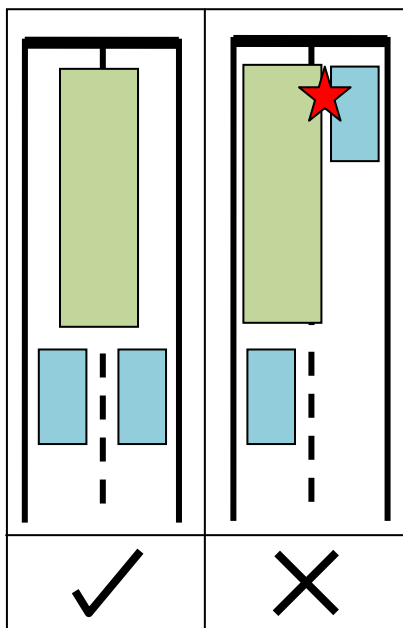
Figure 2.12 Roundabout sign with 30km/hr advisory speed sign, installed on approaches to the C-roundabout



2.2.2 Incorrect lane use by trucks and buses

As explained earlier, the intention of the C-roundabout design is for trucks and buses to straddle both of the lanes on the approach to the roundabout and through the roundabout. This is because the roundabout is designed only for two 99 percentile cars to travel alongside each other through the roundabout – the lanes are narrow to encourage cyclists to use the full lane (ie travel in the centre of the lane) and to discourage risky overtaking behaviour by motorists. It is important that trucks/buses straddle the lanes, to ensure they do not attempt to travel through the roundabout with a car next to them – this is likely to result in sideswipe crashes because there is not enough space for a car and truck to track through the roundabout side by side. Refer to figure 2.13 for an illustration of correct and incorrect truck/bus approach lane use.

Figure 2.13 Correct and incorrect truck/bus lane use on approach to C-roundabout



When the C-roundabout at Palomino Dr/Sturges Rd was originally installed it was anticipated that, due to the narrow lanes on the southern and northern approaches, trucks and buses would naturally straddle both lanes. However, video surveys undertaken following the initial construction showed that 73% of trucks/buses approached the roundabout in one lane (ie they tried to fit into one lane). Figure 2.14 illustrates this issue.

Figure 2.14 Photo of incorrect lane use by a bus on the Palomino Dr approach to Palomino Dr/Sturges Rd roundabout



The bus has approached the roundabout in one lane, and then is about to cut across lanes to go through the roundabout. If the following vehicle had reached the limit line at the same time as the bus, the bus would have sideswiped the car.

As a result, measures were developed to communicate to truck and bus drivers that they should straddle the approach lanes, and to car drivers to stay behind trucks/buses and not squeeze in next to them. The following measures were developed and implemented (also see figure 2.16, which illustrates the measures implemented to improve truck/bus lane use):

- 1 Increased thickness of edge lines and lane lines on the approaches (northern and southern approaches):
The thickness of the lane lines, edge lines and the NSAAT (broken yellow) lines were increased from the standard 100mm thickness to 200mm thickness (figure 2.16).
- 2 Install a new truck lane-use sign:
The sign initially installed on the northern and southern approaches was a small sign 0.6m in height. As a result of the issue of the poor lane use by trucks/buses, a new sign 1.9m in height was designed and installed (figure 2.15).

Figure 2.15 New truck lane-use sign for C-roundabout approaches

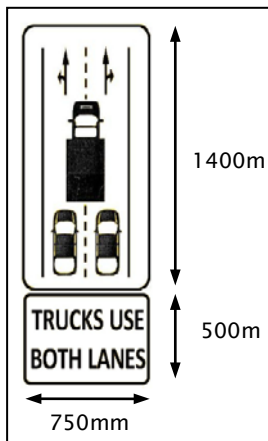
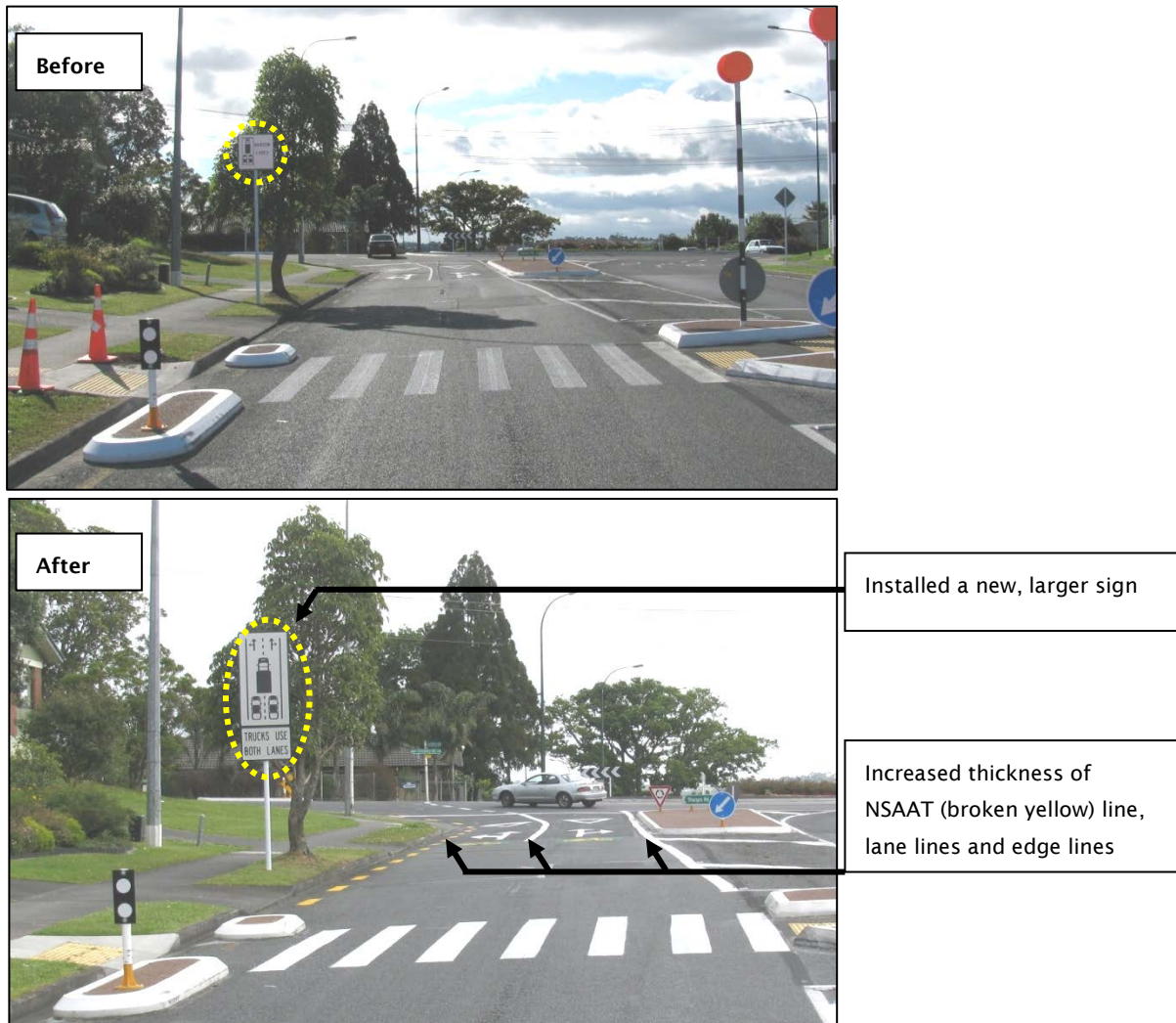


Figure 2.16 Photo looking north at the Palomino Dr approach to the Palomino Dr/Sturges Rd roundabout, before and after the measures were implemented to improve truck/bus lane use⁴



Following the implementation of the above measures, a video survey was undertaken to determine whether there had been an improvement in truck lane use. It found that 53% of trucks/buses approached the roundabout in one lane, which was a 20% improvement from before the measures were implemented. This video survey was done approximately three weeks after the measures were installed – the lane use may have improved since then, as it may take drivers a few weeks to start noticing the sign. In the car driver survey, which was carried out in May 2010, it was found that 83% of drivers noticed the truck lane-use sign; 88% understood that trucks should straddle both lanes; and 27% understood that cars should stay behind trucks (refer to section 2.5.3 of this report). This was a very good response in terms of the number of drivers reading the sign.

⁴ Non-standard signs and markings, which do not comply with the Land Transport Rule: Traffic Control Devices (TCD Rule), have been used in undertaking this research. Refer to page 3 of this report.

2.2.3 Conclusions regarding issues encountered in the construction of the C-roundabout

From the issues encountered in the construction of the Palomino Dr/Sturges Rd C-roundabout, we concluded that the following should be undertaken when installing a C-roundabout:

- Ensure the circulating lane lines are correctly set out on-site. This is particularly important for C-roundabouts because of their tight geometry.
- Circulating lane lines should be thick (200mm) and closely spaced (1:1 metre spacing, ie 1m length, 1m gap), to encourage drivers to stay in their own lane. This is important because of the tight geometry of C-roundabouts and the potentially higher risk of sideswipe crashes.
- To keep speeds down in the conflict area, the size of the advisory speed sign (30km/hr) installed below the roundabout sign should be increased to 750mm, as this may assist in reducing the risk of sideswipe crashes. Surveys indicated that only a low percentage (35%) of drivers had noticed the 650mm sign.
- The new truck lane-use sign should be installed on the C-roundabout approaches to communicate to truck and bus drivers that they should straddle the approach lanes, and to car drivers to stay behind trucks/buses and not squeeze in next to them.
- Edge lines and lane lines on the approaches should be thick (200mm) to reinforce to truck and bus drivers that the lanes are narrow, and to encourage them to straddle the lanes.

2.3 Safety of the C-roundabout

2.3.1 Introduction

As explained earlier, the primary aim of the C-roundabout is to improve the safety of cyclists at multi-lane roundabouts. The concept of the design is to decrease vehicle speeds through the roundabout (to around 30km/hr) by increasing the deflection of the roundabout. This should result in a decrease in the speed differential between cyclists and vehicles, and as a result improve the roundabout's safety for cyclists. The reduced speed should also result in improved safety for other road users (such as pedestrians and motorists), particularly in terms of the severity of crashes.

To assess the safety performance of the C-roundabout, the following tasks were undertaken:

- 1 Literature review
- 2 Vehicle speed survey
- 3 Crash history analysis
- 4 Conflict analysis.

2.3.2 Literature review

The literature review indicated that if speeds could be reduced at roundabouts then their safety would improve.

Previous research done in the *Improved multi-lane roundabout designs for cyclists* report (Campbell et al 2006) came to the following conclusions:

- Reducing the speed of vehicles travelling through a multi-lane roundabout is desirable for cyclist safety and amenity. This reinforces the proposed design concept of this research.

- The predominant cyclist crash pattern at roundabouts is ‘entering vehicle versus circulating cyclist’.
- The continental European tendency has been to design roundabouts with radial approaches, large deflection and a single circulating lane. This low-speed environment reduces both the number and severity of all crashes at these locations. It also improves recognition of cyclists already on the roundabout, as drivers are less likely to ‘selectively identify’ hazards as they are prone to do at higher approach speeds. However, such designs have obvious capacity limitations because of this single-lane arrangement.
- The potential for vehicles cutting across lanes and causing sideswipe crashes should be considered in slower-geometry designs. Careful use of suitable lane marking is required at roundabout entry and exits.
- Circulatory cycle lanes on multi-lane roundabouts are generally not recommended, for safety reasons.

The key findings from a review of recent articles are quoted below:

- **Federal Highway Administration publication – *Roundabouts: an informational guide* (Robinson et al 2000):**

Speed is a fundamental risk factor in the safety of bicyclists and pedestrians. Typical bicyclist speeds are in the range of 20 to 24km/hr and designs that constrain the speeds of vehicles to similar values will minimize the relative speeds and thereby improve safety. Design features that slow traffic such as tightening entry curvature and entry width, and radial alignment of the legs of a roundabout, such with the urban compact design, are considered safe treatments for bicyclists.

Most European countries have the following policies:

- *Avoid bike lanes on the outer edge of the circulatory roadway.*
 - *Allow bicyclists to mix with vehicle traffic without any separate facility in the circulatory roadway when traffic volumes are low on single lane roundabouts operating at lower speeds.*
 - *Introduce separated bicycle facilities outside the circulatory roadway when vehicular and bicycle volumes are high.*
- ***Design types of cycle facilities at roundabouts and their effects on traffic safety: some empirical evidence* (Daniels et al 2009)**

The results for the study sample suggest that the construction of a roundabout generally raises the number of severe injury crashes with bicyclists, regardless of the design type of cycle facilities.

Regarding the effects on all injury crashes, roundabouts with cycle lanes perform worse compared to the three other design types (mixed traffic, separate cycle paths and grade-separated cycle paths).

The principle of the C-roundabout design seems to be in agreement with the findings of the literature review, as it involves reducing the maximum speed through the roundabout from 50km/hr to 30km/hr, and encourages cyclists to mix with other traffic.

Refer to the *Improved multi-lane roundabout designs for cyclists* report (Campbell et al 2006) for a more comprehensive literature review in regards to safety at roundabouts.

2.3.3 Vehicle speed survey

2.3.3.1 Methodology

In order to analyse the effectiveness of the C-roundabout design in reducing through vehicle speeds, surveys were undertaken at the Palomino Dr/Sturges Rd roundabout. At this site the C-roundabout concept of increasing the deflection of the roundabout was applied, and two of the approaches (northern and southern) were reconstructed to fully comply with the C-roundabout configuration of two narrow lanes. The design of the deflection was discussed in section 2.1.1 of this report.

A ‘before’ and ‘after’ vehicle speed survey was undertaken to assess the extent to which speeds were affected. The through vehicles speeds were measured during off-peak as well as peak periods and consisted of manual measurements with a stopwatch. The manual observations targeted only unimpeded through vehicles (ie those that did not have to give way to circulating traffic on the roundabout). Refer to appendix A for further details of the speed survey methodology, as well as the survey measurements.

2.3.3.2 Vehicle speed survey results

The results from the speed survey are presented in table 2.1. Box plots comparing the before and after speeds are given in figures 2.18 and 2.19. Figure 2.17 illustrates the change in the 85th percentile through speeds. Refer to appendix A for further details of the speed survey.

Figure 2.17 85th percentile speeds before and after Palomino Dr/Sturges Rd was changed to a C-roundabout

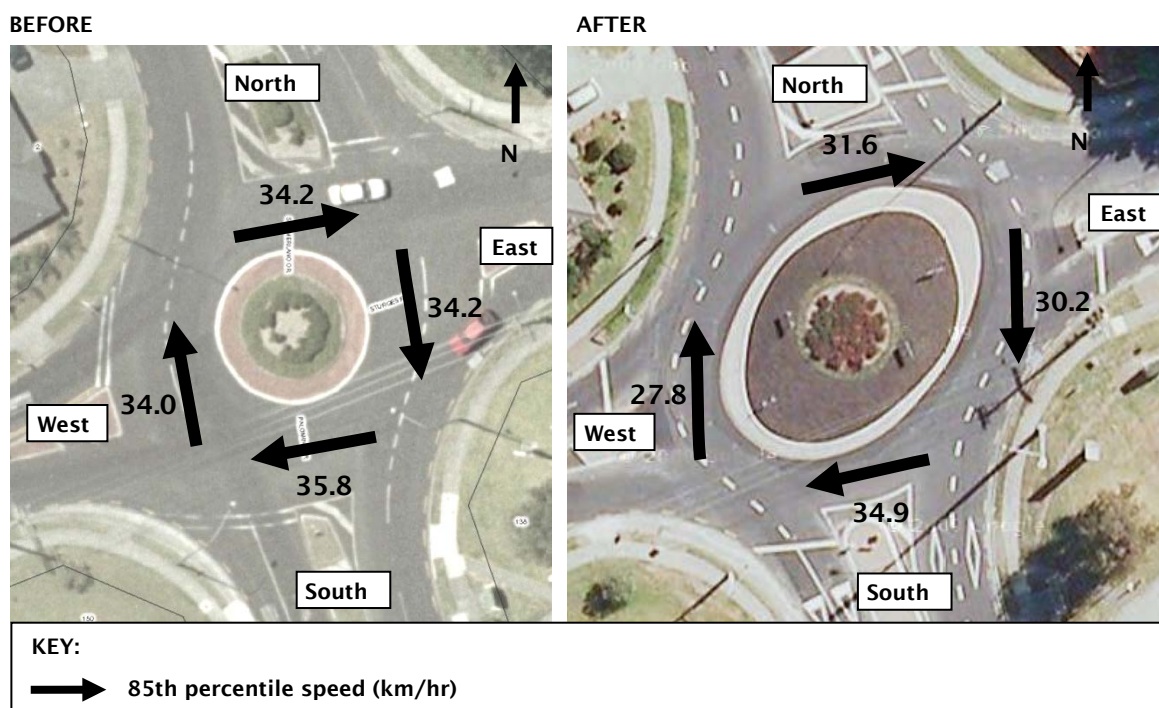


Table 2.1 Before and after speed survey results for average, 85th percentile and 95th percentile speeds

Speed survey results for before and after the Palomino Dr/Sturges Rd roundabout was changed to the C-roundabout design					
	North to south	South to north	West to east	East to west	Average for intersection
Average (mean) speed (km/hr)					
Before	29.82	29.85	30.28	31.26	30.30
After	26.77	25.09	28.04	30.17	27.52
Difference	- 3.05	- 4.76	- 2.24	- 1.09	- 2.78
85th percentile speed (km/hr)					
Before	34.22	34.04	34.16	35.83	34.56
After	30.22	27.83	31.63	34.87	31.14
Difference	- 4.00	- 6.21	- 2.53	- 0.96	- 3.42
95th percentile speed (km/hr)					
Before	35.63	37.03	35.74	40.61	37.25
After	32.82	28.97	33.25	37.42	33.12
Difference	- 2.81	- 8.06	- 2.49	- 3.19	- 4.13

Figure 2.18 North-to-south and south-to-north vehicles speeds, before and after reconstruction with a C-roundabout design

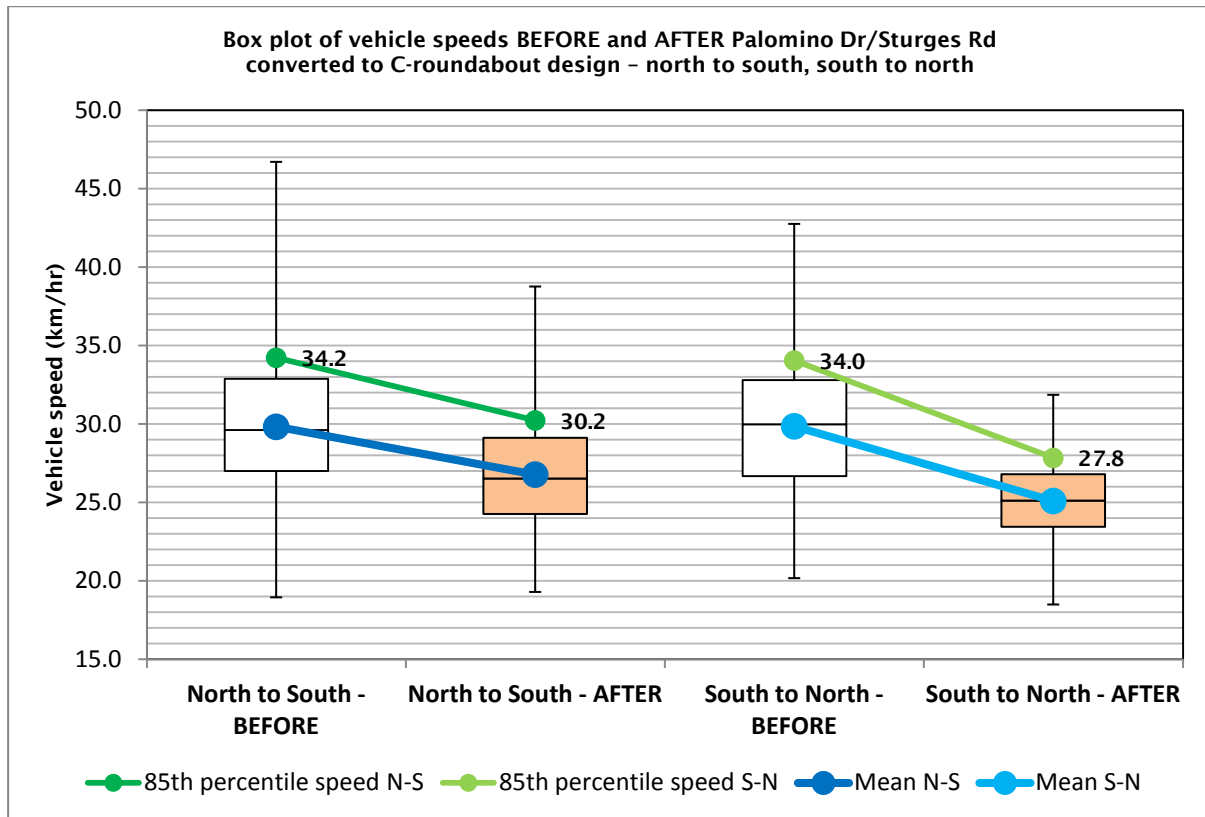
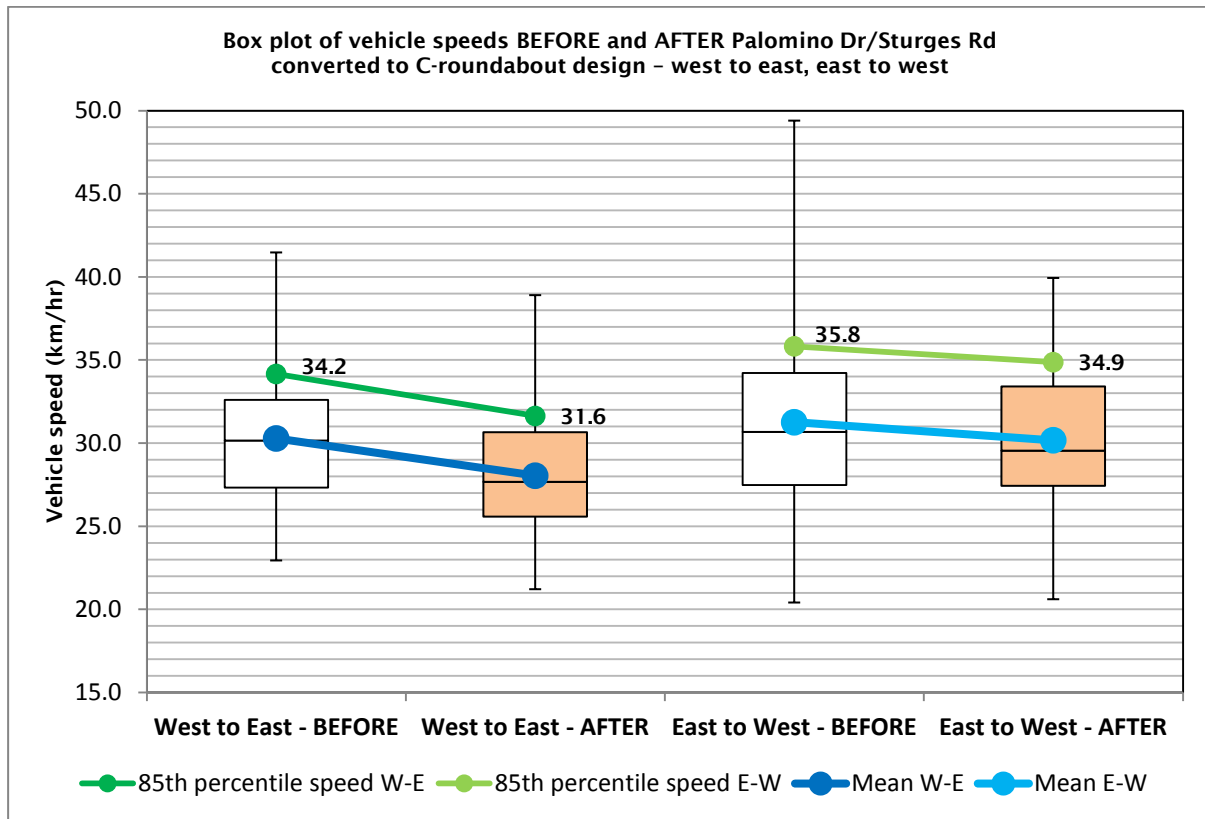


Figure 2.19 West-to-east and east-to-west vehicles speeds, before and after reconstruction with a C-roundabout design



From the graphs and table, the following effects of the C-roundabout can be noted:

- The 85th percentile speed reduced from 34–36km/hr to 28–35km/hr
- The average speed reduced from 30–31km/hr to 25–30km/hr.
- The 95th percentile speed reduced from 36–41km/hr to 29–37km/hr.
- The largest drop in speed occurred for the south-to-north movement: the average speed reduced by 5km/hr, the 85th percentile reduced by 6km/hr, and the 95th percentile reduced by 8km/hr.
- For the north-to-south movement: the average speed reduced by 3km/hr, the 85th percentile reduced by 4km/hr and the 95th percentile reduced by 2.8km/hr.
- For the west-to-east movement: the average speed reduced by 2km/hr, the 85th percentile reduced by 3km/hr and the 95th percentile reduced by 2km/hr.
- The smallest drop in speed occurred for the east-to-west movement: the average and 85th percentile speed reduced by only 1km/hr, and the 95th percentile reduced by 3km/hr.

Thus, the results of the vehicle speed survey showed that the C-roundabout design was successful in achieving a low speed environment, particularly for the north-to-south, south-to-north and east-to-west movements. The 85th percentile through vehicle speeds reduced from 35km/hr to 31km/hr (average for the roundabout).

On the two approaches that fully complied with the C-roundabout design (northern and southern approaches) the vehicle speeds dropped significantly and achieved 85th percentile speeds of 28km/hr and 30km/hr. This was a good result, as the vehicle speeds were now close to the speed a cyclist would be

travelling through the roundabout on these approaches, which is one of the main objectives of the C-roundabout design in improving cyclist safety at multi-lane roundabouts.

The east-to-west movement had the highest 85th percentile speed of 35km/hr. The remaining movements had 85th percentile speeds in the range of 28–32km/hr.

2.3.3.3 Comparison between expected and measured speeds

The ‘before’ speeds measured at the Palomino Dr/Sturges Rd roundabout were lower than expected. The through speeds were on average approximately 14km/hr lower than what would be expected based on the relationship between the maximum path radii and the 85th percentile vehicle through speed. (Refer to table 2.2 for a comparison between the expected speeds and those measured in the speed survey.) We are aware that restricted visibility can have an impact on the vehicle speeds through the roundabout, which may have contributed to the lower speeds before the changes were made (refer to *Improved multi-lane roundabout designs for urban areas* (Campbell et al 2012)). As the original speeds were less than expected, the drop in the speeds at the roundabout was also less than originally expected.

However the vehicle speeds achieved after the reconstruction were around 30km/hr, which is the desired speed environment for cyclist safety. The speeds after the C-roundabout construction were on average approximately 3km/hr lower than what would be expected based on the relationship between the maximum path radii and the 85th percentile unimpeded vehicle through speed (refer to table 2.3).

Table 2.2 Comparison between expected 85th percentile speeds and measured 85th percentile speeds for Palomino Dr/Sturges Rd roundabout prior to reconstruction

Before roundabout reconstruction				
Movement	Maximum path radius	Expected 85th percentile speed ^a	Measured 85th percentile speed	Difference
North to south	95m	49km/hr	34.22km/hr	- 14.78km/hr
South to north	80m	45km/hr	34.04km/hr	- 10.96km/hr
West to east	100m	50km/hr	34.16km/hr	- 15.84km/hr
East to west	100m	50km/hr	35.83km/hr	- 14.17km/hr

a) Based on the relationship given in Austroads (1993).

Table 2.3 Comparison between expected 85th percentile speeds and measured 85th percentile speeds for Palomino Dr/Sturges Rd roundabout after reconstruction with a C-roundabout design

After roundabout reconstructed as a C-roundabout				
Movement	Maximum path radius	Expected 85th percentile speed ^a	Measured 85th percentile speed	Difference
North to south	40m	32km/hr	30.22km/hr	- 1.78km/hr
South to north	40m	32km/hr	27.83km/hr	- 4.17km/hr
West to east	50m	36km/hr	31.63km/hr	- 4.37km/hr
East to west	50m	36km/hr	34.87km/hr	- 1.13km/hr

a) Based on the relationship given in Austroads (1993).

2.3.4 Crash analysis

2.3.4.1 Methodology

The crash history at the Palomino Dr/Sturges Rd roundabout was reviewed for before and after the roundabout was converted to a C-roundabout. This trial site did not have any cyclist crashes before or after it was converted to a C-roundabout. The crash analysis involved reviewing the safety of all road users. The reported crashes were obtained using the NZTA's Crash Analysis System (CAS). Collision diagrams for before and after the roundabout reconstruction were prepared. Some corrections to the CAS collision diagram were made based on a review of the Traffic Crash Reports – for example, corrections to the crash movement type and the crash location on the roundabout.

2.3.4.2 Crash analysis results

- *Before it was reconstructed as a C-roundabout:* There were 21 crashes during the 9.25-year period (December 1999, which is when the intersection was originally converted into a roundabout, to April 2009), ie 2.3 crashes per year. (Refer to figure 2.20 for the collision diagram for before the roundabout reconstruction.)

The following crash patterns existed:

- loss-of-control crashes – 10 loss-of-control crashes occurred, ie approximately 1.1 per year
 - 'entry versus circulating' crash on the southern approach (HA crash movement) – 4 crashes occurred, ie 0.4 per year
- *After it was reconstructed as a C-roundabout:* There were four crashes during the 2.5 year period April 2009 to Nov 2011. (Refer to figure 2.21 for the collision diagram for after the roundabout reconstruction.)

The crashes details were as follows:

- loss-of-control crash for the northbound through movement, due to the through vehicle travelling too fast for the roundabout
- an 'entry versus circulating' crash on the western approach (HA crash movement) in May 2009
- a rear-end crash on the eastern approach (FB crash movement) in 2010
- a sideswipe crash between vehicles travelling from the north approach to the south approach (GF crash movement) in 2010.

There was one other loss-of-control crash since the reconstruction, but this was excluded from the crash analysis as it involved a stolen vehicle that was travelling too fast for the roundabout.

- *Comparison between before and after it was reconstructed as a C-roundabout:* There were 2.3 crashes per year before the reconstruction (9.25-year period), and 1.6 crashes per year since the reconstruction (2.5-year period). The crash rate had not changed significantly in that time – it was not more than the 'critical change in the mean' of 1.3 for this site and thus it could have occurred by chance (based on Austroads 2009a). Thus, the safety of the roundabout appeared to have remained the same.

At the time of this research there had not been many crashes following the construction of the roundabout, so there was no reason for concern regarding the safety of the C-roundabout. Also, no new crash patterns had become evident during that time period (the two crash patterns that existed before the reconstruction were loss-of-control and 'entry versus circulating').

Therefore we concluded that the safety of the roundabout had not changed. However, as there had only been a short period since the reconstruction, one to two more years of crash data would be required to conclusively determine whether or not the C-roundabout was safer.

- *Injury crashes:* In the 9.25-year period prior to the reconstruction there were only three injury crashes at the roundabout, ie 0.32 injury crashes/year. In the 2.5-year period following the reconstruction, there were no injury crashes at the roundabout. With the lower speeds we would expect the injury crash rate to drop, although the non-injury crash rate may not change.
- *Sideswipe crashes:* It was thought that there may be an increase in sideswipe crashes because of the narrow lanes. However, there had been only one sideswipe crash in the 2.5 years since the construction of the C-roundabout.

Figure 2.20 CAS collision diagram for Palomino Dr/Sturges Rd intersection BEFORE the new C-roundabout was constructed (9.25 years, December 1999–April 2009)

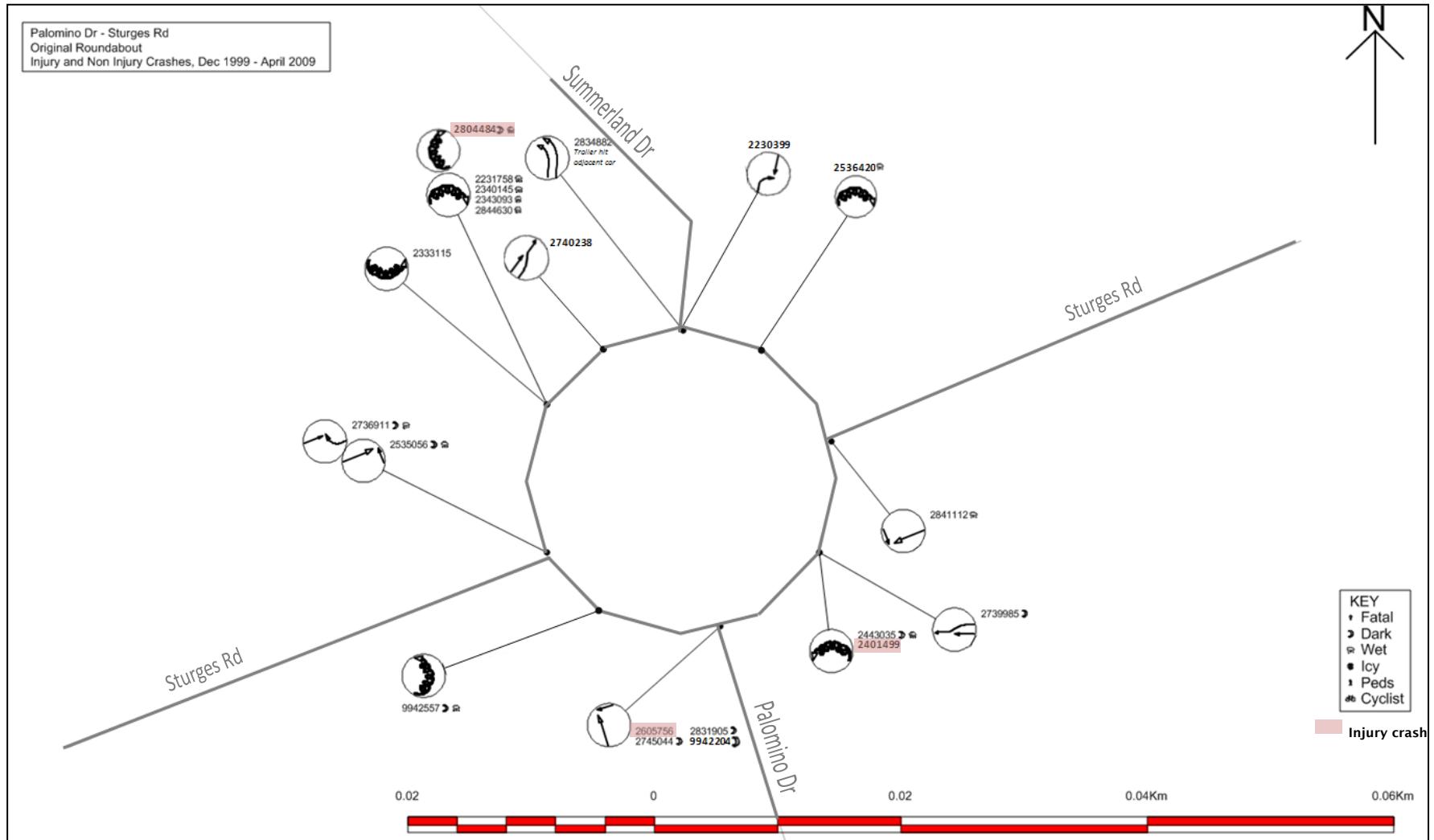
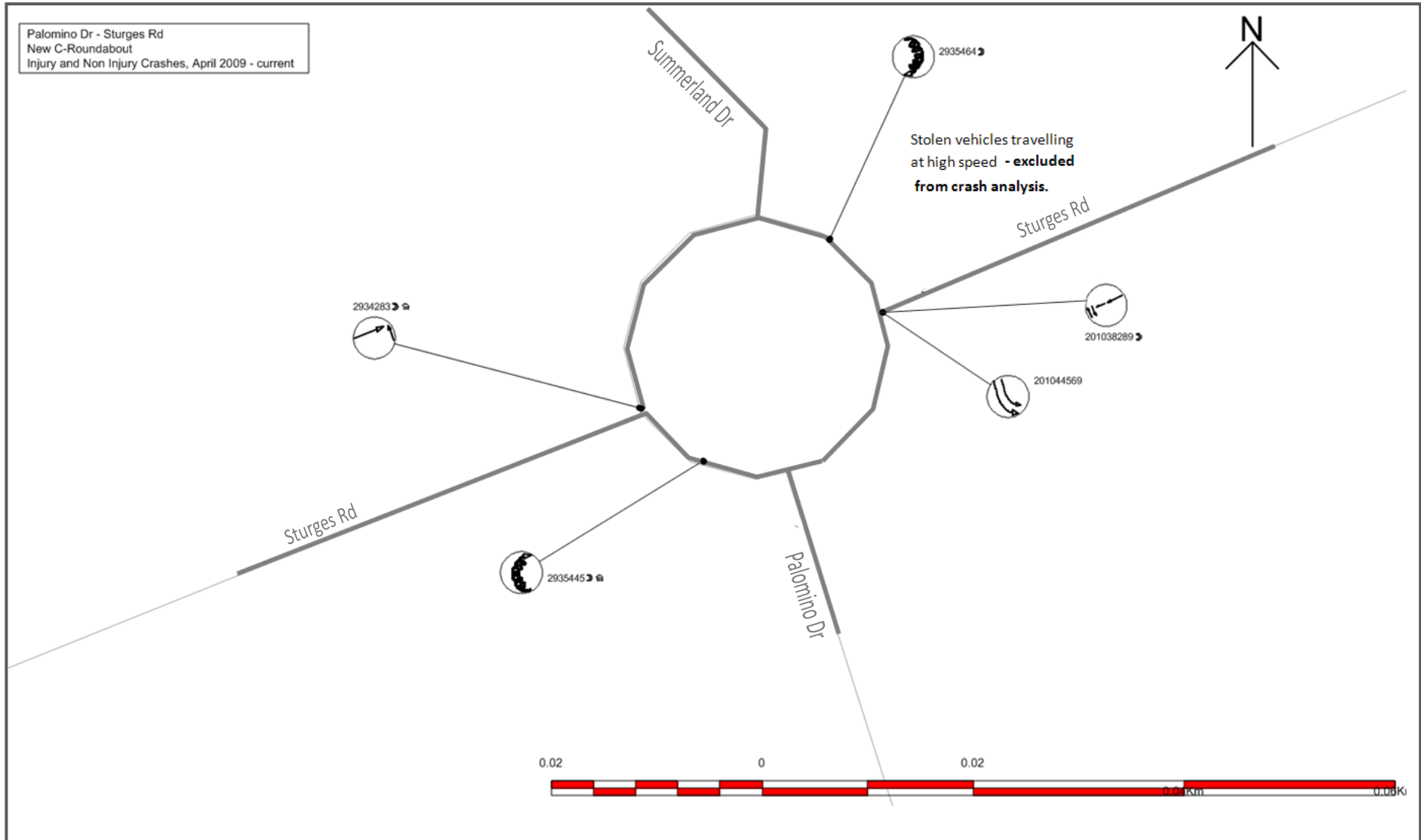


Figure 2.21 CAS collision diagram for Palomino Dr/Sturges Rd intersection AFTER the new C-roundabout was constructed (2.5 years, April 2009–Nov 2011)

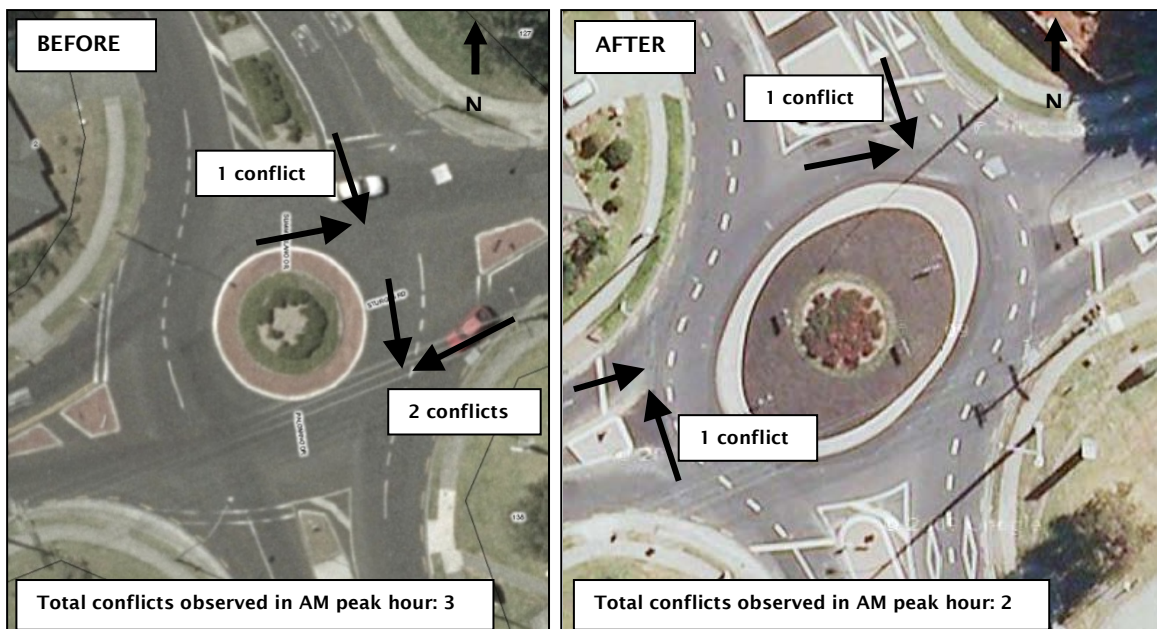


2.3.5 Conflict analysis

A brief conflict analysis was undertaken at the Palomino Dr/Sturges Rd roundabout for before and after it was reconstructed with the C-roundabout design.

The conflict analysis was undertaken during the AM peak hour (8–9am) using video footage of the roundabout. There were three conflicts (HA movements) identified at the roundabout prior to reconstruction, and there were two conflicts (HA movements) identified after the C-roundabout was installed (refer to figure 2.22). All the conflicts were ‘entry versus circulating’ crashes. In the ‘before’ scenario, the conflicts were at the northern and eastern entries to the roundabout – the crash analysis showed there had been one crash at each of these entries. In the ‘after’ scenario, the conflicts were at the northern and western entries to the roundabout – the crash analysis showed one crash at the western entry, but none at the northern entry since the reconstruction. Thus, there was no evidence to suggest the safety of the C-roundabout was any worse than the previous roundabout.

Figure 2.22 Conflicts identified at the Palomino Dr/Sturges Rd roundabout before and after the C-roundabout was installed



2.3.5.1 Sideswipe conflicts

It was thought that the narrow approach lanes and the greater shift through the roundabout might give rise to an increase in the number sideswipe crashes. Some residents and drivers commented that they had seen many near-miss sideswipe crashes, but at the time of this research, this had not shown up in the CAS statistics.

2.3.6 Summary regarding the safety of the C-roundabout

- The Palomino Dr/Sturges Rd C-roundabout proved to be successful in achieving a lower-speed environment, with the 85th percentile through speeds being reduced to around 30km/hr, which was the desired speed environment for cyclist safety. The vehicle speed on the two approaches that fully complied with the C-roundabout configuration dropped significantly to 30km/hr or less. This was a good result as the vehicle speeds were now close to the speed a cyclist would be travelling through the roundabout on these approaches, demonstrating the success of the C-roundabout design. These

slower speeds are safer for all other road users (motorists and pedestrians), and should result in less-severe crashes.

- The crash analysis of the Palomino Dr/Sturges Rd roundabout indicated that the safety of the roundabout had not changed significantly since the C-roundabout was installed (2.3 crashes/year before to 1.6 crashes/year after). However, one to two more years of crash data for the C-roundabout would be needed to determine whether the C-roundabout was safer than the previous roundabout. There had been no injury crashes in the 2.5 years since the installation of the C-roundabout (compared with 0.32 injury crashes/year before it). With the lower design speed we would expect the injury crash rate to drop, although the non-injury crash rate may not change. There may be an increase in sideswipe crashes in the future due to the narrow lanes; however, at the time of this research there had been only one sideswipe crash since the C-roundabout was installed.
- The brief conflict analysis undertaken for the Palomino Dr/Sturges Rd C-roundabout also suggested that the safety of this roundabout had not changed and there were no safety concerns about it.

2.3.7 Recommendations regarding the safety of the C-roundabout

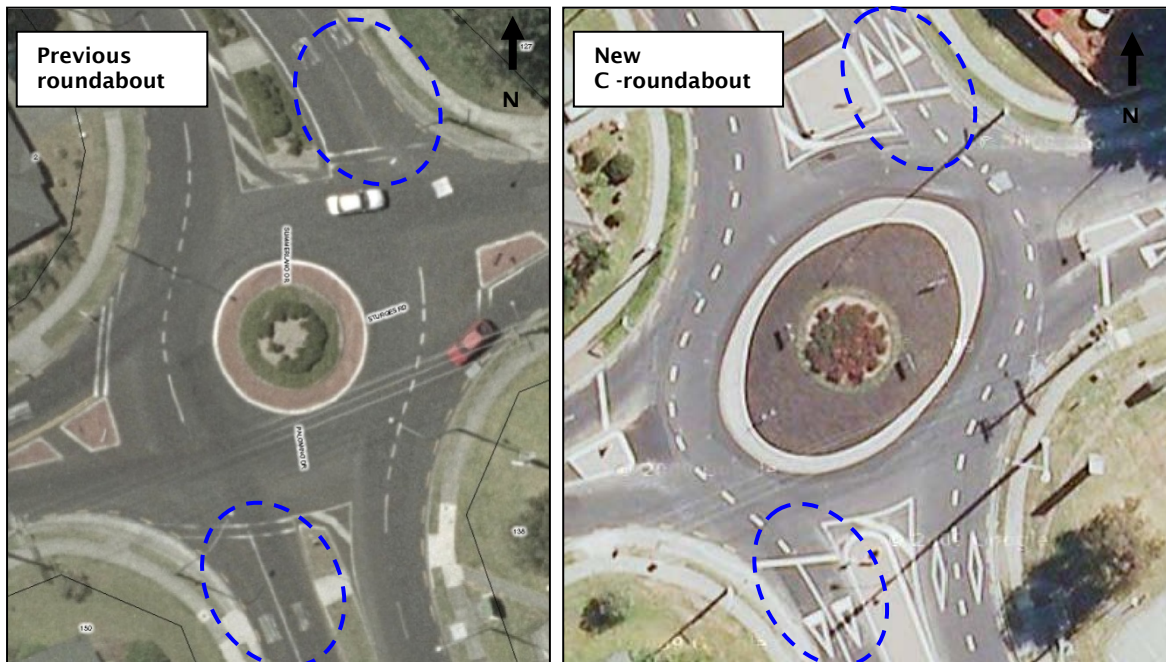
It is recommended that the safety of the C-roundabout should be reviewed in one to two years time (ie a total crash history of five years) to determine whether the C-roundabout is safer than the previous roundabout. Two further C-roundabouts have been constructed in Auckland and this should provide enough data to conclusively assess the safety of the C-roundabout.

2.4 Capacity of the C-roundabout

2.4.1 Introduction

The operation of the Palomino Dr/Sturges Rd trial site was studied to assess whether there was any difference in capacity between a conventional multi-lane roundabout and the C-roundabout. The reconstruction of the Palomino Dr/Sturges Rd roundabout involved converting the northern and southern approaches from the conventional multi-lane design to the C-roundabout design (refer to figure 2.23).

Figure 2.23 Palomino Dr/Sturges Rd roundabout before and after the new C-roundabout configuration was installed



To compare the capacity of the original roundabout with the C-roundabout design:

- SIDRA modelling for before and after the installation of the C-roundabout was undertaken
- on-site observations and measurements were taken before and after the installation of the C-roundabout – this included measuring entry flow and circulating flow, and delay measurements.

The following factors were thought to potentially have an impact on the C-roundabout's capacity:

- the narrowing of the entry-lane widths
- the reduction of the roundabout design speed because of the increased deflection
- the proportion of large trucks and buses on the two-lane approaches (since they take up both approach lanes, the C-roundabout entry capacity could be less than a conventional arrangement).

S-Paramics modelling was undertaken to:

- more accurately model the impact of trucks/buses on the C-roundabout approaches
- assess whether Paramics would be a good micro-simulation tool for modelling the C-roundabout.

2.4.2 Lack of congestion at Palomino Dr/Sturges Rd roundabout

At the time of this research at the Palomino Dr/Sturges Rd site, the capacity implications of converting the existing multi-lane roundabout into a C-roundabout were difficult to assess because of the low traffic flows (total intersection flow 1665 veh/hr and 1710 veh/hr in the AM and PM peak hours, respectively). With a design life of 12 years, it would take 12 years at a traffic growth rate of 3% per annum for the roundabout to reach capacity. There was very little queuing and stop line delay, and very few congested periods at the roundabout (only 13 minutes in total for both peak periods).

Initially it had been anticipated that the gap acceptance and follow-up headways would be surveyed, however there were insufficient periods of congestion (13 minutes) for these measurements to be

undertaken. As a result, the review of the capacity was undertaken by recording the entry flow versus circulating flow, and measuring delays per lane. These measurements were undertaken using the video surveys.

SIDRA modelling was also undertaken for the roundabout

2.4.3 SIDRA modelling

The following SIDRA models were developed for the Palomino Dr/Sturges Rd roundabout :

- before conversion to C-roundabout
- after conversion to C-roundabout
- after conversion to C-roundabout, with adjustments to assess the impact of trucks.

The above models were prepared for the PM peak hour of 4.45–5.45pm.

2.4.3.1 BEFORE and AFTER conversion to C-roundabout: geometric changes

The results of the SIDRA modelling of the Palomino Dr/Sturges Rd roundabout indicated that for an uncongested roundabout, conversion to a C-roundabout has very little impact on the average delay (7.5sec/veh before, 8.1sec/veh after), the degree of saturation (0.579 before, 0.568 after) and the design life (12 years before, 12 years after). Table 2.4 shows a summary of the results.

Table 2.4 SIDRA results for Palomino Dr/Sturges Rd roundabout before and after it was converted to a C-roundabout

	BEFORE converted to C-roundabout	AFTER converted to C-roundabout
Average delay at intersection	7.5 sec/veh	8.1 sec/veh
Maximum degree of saturation	0.579	0.568
Design life ^a	12 years	12 years

a) The estimate for the design life is based on when the roundabout reaches zero practical spare capacity (practical degree of saturation of 0.85) with a 3% traffic growth rate per year.

SIDRA calculated a minor increase in delay due to the C-roundabout design because of the:

- decreased speeds through the roundabout
- narrower approach lanes
- increased diameter of the roundabout.

SIDRA assumes that the critical gap and follow-up headways increase when the approach lanes are narrowed and when the diameter of the roundabout is increased. Therefore SIDRA assumed that the narrower approach lanes and increased roundabout diameter of the C-roundabout would have a negative impact on its capacity. It was not possible to check the critical gap and follow-up headways calculated by SIDRA by on-site measurements, due to the lack of congested periods at this roundabout (refer to section 2.4.2).

The geometric delay for the through movements was calculated to be larger after the roundabout was converted to a C-roundabout, due to the reduced speeds through the roundabout (refer to section 2.3.3). As a result the average delay at the roundabout after it was converted to a C-roundabout was calculated to be slightly more than before the conversion.

2.4.3.2 SIDRA inputs to model the C-roundabout

The following input parameters were changed to model the roundabout site conditions before and after it was converted to the C-roundabout design, in order to obtain more realistic results:

- entry lane widths
- island diameter
- circulating width
- negotiation speed and negotiation distance for through movements
- negotiation radius for left-turn movements.

It was important to input into SIDRA the negotiation speed and distance for the through movements and the negotiation radius for the left turns, as SIDRA did not correctly calculate these values on its own. This may have been due to the oval shape of the roundabout. SIDRA seems to calculate the correct negotiation speed and distance for circular roundabouts but not for oval or unusually shaped roundabouts. Without inputting the negotiation speed, distance and radius, the speeds were over-estimated and the average intersection delay for the C-roundabout design was underestimated, suggesting a reduction in delay (refer to table 2.5).

Table 2.5 SIDRA results for Palomino Dr/Sturges Rd roundabout before and after it was converted to a C-roundabout

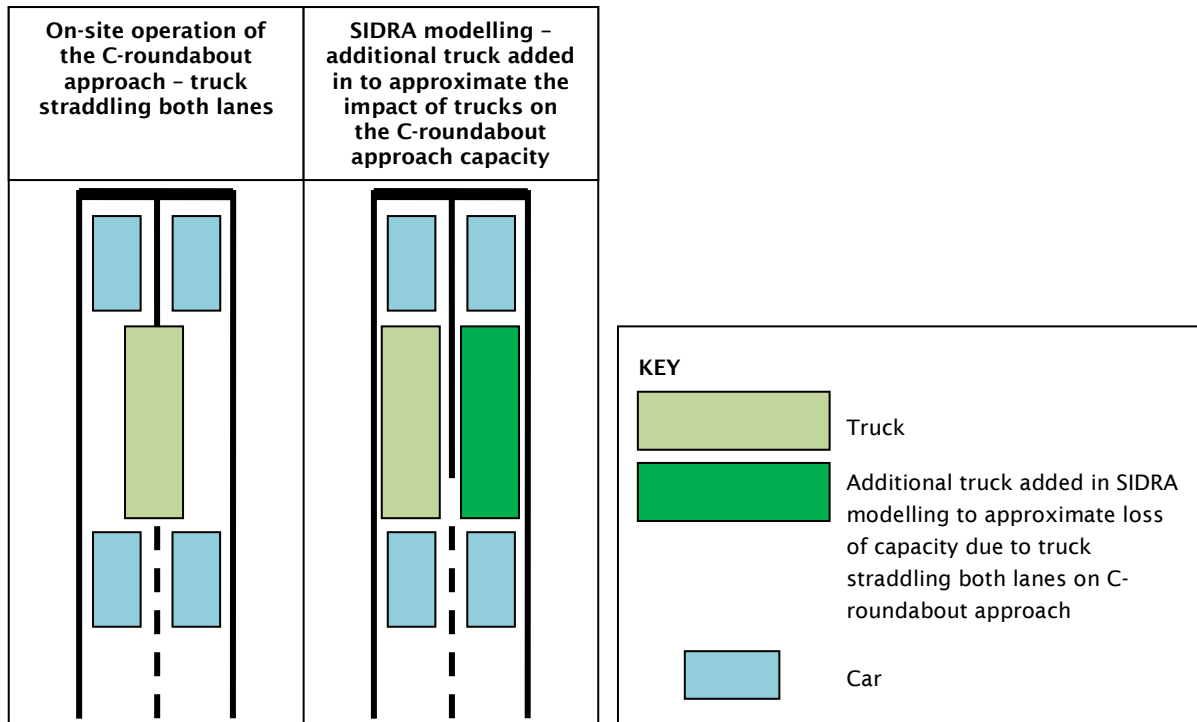
	AFTER converted to C-roundabout	
	With correct negotiation speeds and distances inputted	With SIDRA-calculated negotiation speeds and distances
Average delay at intersection	8.1 sec/veh	6.8 sec/veh
Maximum degree of saturation	0.568	0.568

Thus, inputting the negotiation speed and distance is important for the SIDRA modelling of the C-roundabout. The average speeds measured in the speed survey (refer to section 2.3.3.2) were inputted as the negotiation speeds for the through movements.

2.4.3.3 Impact of trucks on approach-lane capacity, modelled in SIDRA

As trucks and buses are required to straddle the approach lanes for the C-roundabout design, it was anticipated that this could impact on the approach-lane capacity. In order to approximate this in SIDRA, the number of trucks was doubled – figure 2.24 shows the loss of capacity due to the large vehicles straddling both lanes and how this was approximated in the SIDRA modelling. It was assumed that this would account for the additional queuing space that each truck would ‘take up’.

Figure 2.24 Illustration of approximation of impact of trucks on C-roundabout approach capacity



The above method was used on the southern approach to the Palomino Dr/Sturges Rd roundabout. The southern approach has a truck/bus percentage of 2.5% during the PM peak hour. To estimate the impact of the trucks on the C-roundabout approach, the truck/bus numbers were doubled, resulting in a truck/bus percentage of 4.9%. The impact on the capacity was minimal, with the delays for this approach only increasing by 0.1 seconds/vehicle. Also, the design life did not change.

It was concluded that if the truck/bus percentage is small (which may often be the case during peak periods) their impact on the capacity of C-roundabout approaches is minimal. (The impact of uneven lane queues is discussed in section 2.4.7). In this case the Palomino Dr/Sturges Rd roundabout had little queuing on the two-lane approaches and so the impact of trucks/buses was not considered to be a concern.

2.4.3.4 Recommendations for SIDRA modelling

The following further research is recommended:

- Determine whether the critical gap and follow-up headways calculated by SIDRA are correct for the C-roundabout situation. The two new C-roundabouts that have been constructed at more congested sites in Auckland could be used to obtain more conclusive results.
- Determine whether doubling the truck numbers on the C-roundabout approaches in SIDRA modelling is a reasonable method to approximate their impact on capacity, as long as there is not significant queuing on the approaches. To do this the author of SIDRA should be consulted, and further on-site observations should be undertaken at C-roundabouts that have higher traffic flows.

2.4.4 On-site observation and measurements – regression analysis

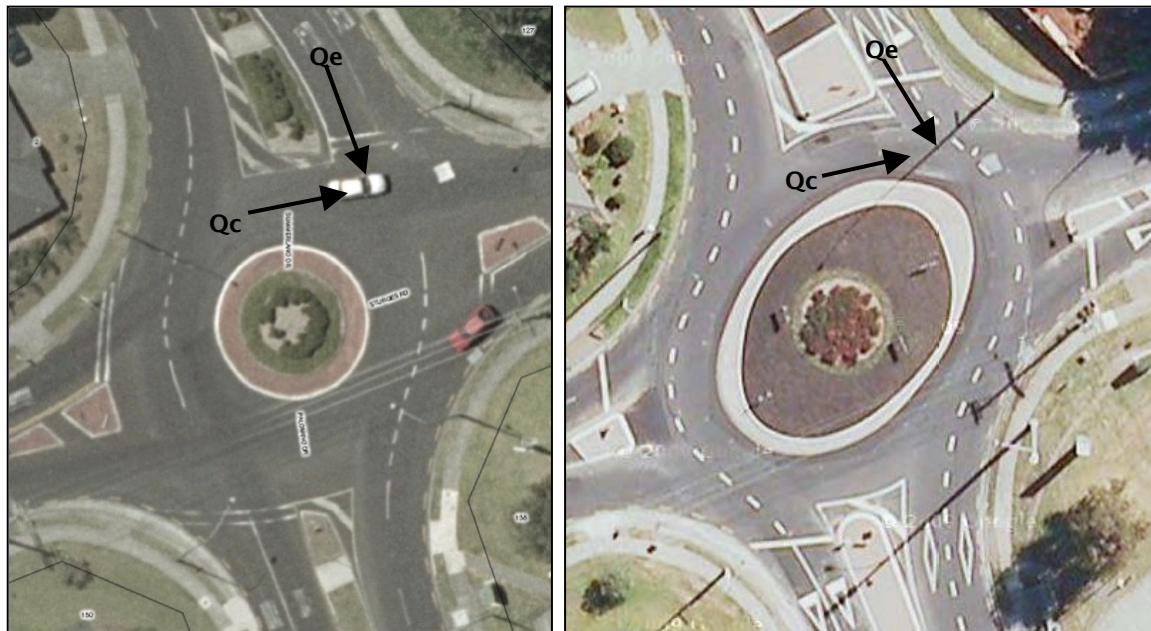
The operational capacity of the roundabout was reviewed using video surveys of the AM and PM peak hours of 8–9am and 4.45–5.45 pm, which were undertaken before and after the roundabout was

converted to the C-roundabout. During the congested periods the entry flow and circulating flows were measured to assess if there was any change in the entry-lane capacity.

2.4.4.1 Entry flow versus circulating flow

The entry flow (Q_e) and circulating flow (Q_c) for the inner lane on the northern approach were measured during congested periods in the AM and PM peak before and after the roundabout was converted to the C-roundabout design (see figure 2.25).

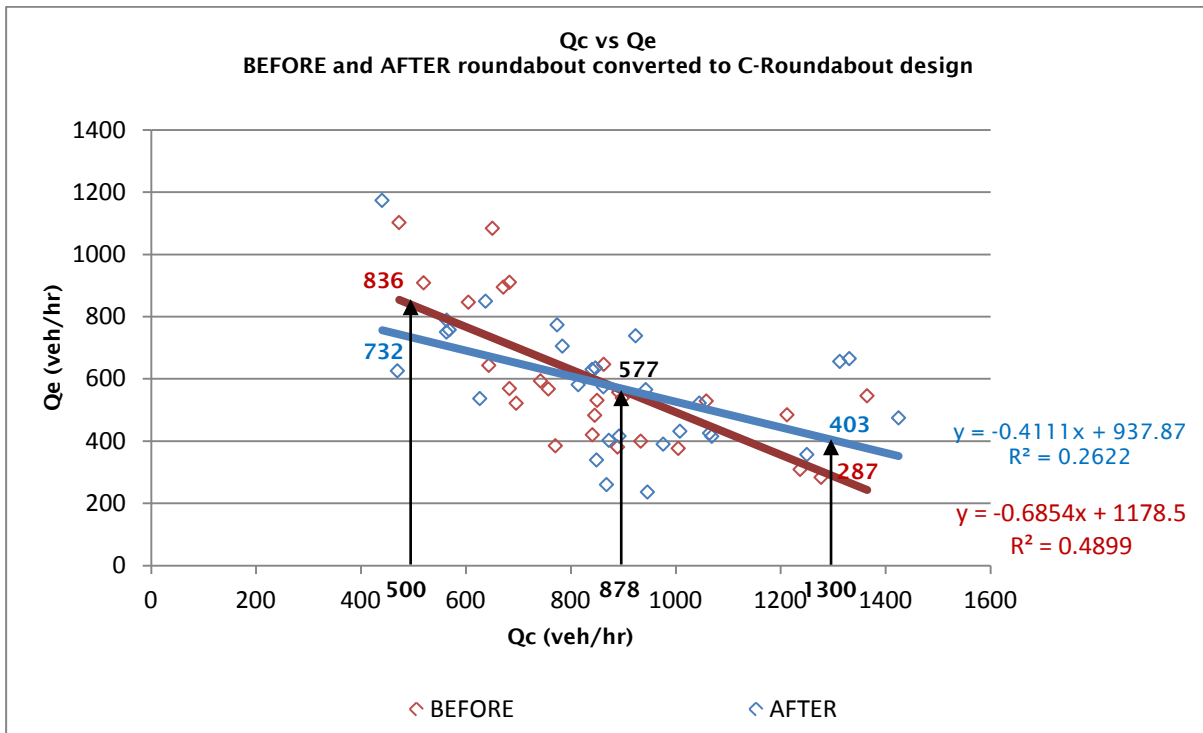
Figure 2.25 Lane on the northern approach for which entry and circulating flows were measured



The results of the measurements are shown in figure 2.26. The measurements suggested that the C-roundabout had:

- the same capacity as the original design when the circulating flows were 878veh/hr
- a drop in capacity when the circulating flows were less than 878veh/hr
- an increase in capacity when circulating flows were greater than 878veh/hr.

Figure 2.26 Measured entry flow versus circulating flow for Palomino Dr/Sturges Rd roundabout before and after it was converted to C-roundabout design



As there was only approximately 13 minutes of congestion during the peak periods, only 26 measurements for the ‘before’ scenario and 30 measurements for the ‘after’ scenario could be obtained for the entry and circulating flow at congestion. As a result, the relationship between the entry flow and circulating flow was based on very few data points. The linear relationship established was not a good fit in either case, particularly for the after scenario (as evident by the low R^2 value of 0.2622). Thus, there was not enough data to conclude whether the capacity of the C-roundabout approach was better or worse than the previous roundabout.

SIDRA indicates there is a very small increase in delay due to the changes in geometry and speeds for the C-roundabout design. However, to confirm this is the case, a C-roundabout with higher flows would need to be studied.

Because of the lack of congestion at the Palomino Dr/Sturges Rd roundabout (only 13 minutes of congestion for both the AM and PM peak periods), there were insufficient on-site measurements to conclude whether the capacity of the Palomino Dr/Sturges Rd C-roundabout was better or worse than the previous roundabout. Measurements of the entry flow and circulating flow seemed to suggest a drop in capacity for the C-roundabout design when the circulating flows were low, and an increase in capacity when circulating flows were higher.

2.4.4.2 Impact of trucks on approach-lane capacity

The video footage did not reveal any adverse impact of trucks on the capacity of the C-roundabout – the queues on the two-lane approaches (northern and southern) were never long, so the impact of trucks was insignificant.

2.4.4.3 Recommendations from on-site observation and measurements

It is recommended that further entry flow and circulating flow measurements be undertaken at a C-roundabout with higher flows and with more periods of congestion, such as the two new C-roundabouts in Auckland. This would enable a stronger relationship between entry and circulating flow to be established and thus evaluate the capacity of the C-roundabout using regression analysis.

2.4.5 Delay measurements

The following delay measurements were undertaken at Palomino Dr/Sturges Rd roundabout before and after it was converted to a C-roundabout:

- 1 Geometric delay (from SIDRA): The geometric delay was obtained from SIDRA's calculation of the delay based on the measured speeds through the roundabout. The geometric delay values calculated by SIDRA are shown in table 2.6.
- 2 Stopped delay (from on-site measurements): The 'stopped delay' for each lane was measured before and after the roundabout was changed to a C-roundabout (measured for 15 minutes in the PM peak hour at 15-second intervals). The 'stopped delay' is the time that vehicles are standing still while waiting in a queue, and this was measured using the method presented in the *Manual of transportation engineering studies* (Institute of Transportation Engineers 2000). The measured stopped delays are shown in table 2.6.

As shown in table 2.6, there was no significant change in the delay per lane when the multi-lane roundabout was converted to a C-roundabout.

Table 2.6 Delay measurements for Palomino Dr/Sturges Rd roundabout before and after it was converted to a C-roundabout

Approach	Lane	Geometric delay (sec/veh)	Stopped delay (sec/veh)
BEFORE CHANGED TO C-ROUNDOABOUT			
South (Palomino Dr)	LT ^a	4.5	1.0
	TR ^b	8.1	0.9
East (Sturges Rd)	LTR ^c	5.6	0.5
North (Summerland Dr)	LT	4.6	2.3
	TR	5.2	3.0
West (Sturges Rd)	LTR	5.2	5.2
AFTER CHANGED TO C-ROUNDOABOUT			
South (Palomino Dr)	LT	5.9	2.5
	TR	8.4	1.3
East (Sturges Rd)	LTR	5.2	0.8
North (Summerland Dr)	LT	5.2	3.0
	TR	6.3	2.5
West (Sturges Rd)	LTR	5.9	6.2

- a) Left-turn and through lane.
- b) Through and right-turn lane.
- c) Left-turn, through and right-turn lane.

2.4.6 S-Paramics modelling

S-Paramics modelling was undertaken to more accurately model the impact of trucks/buses on the C-roundabout approaches and to assess whether S-Paramics would be a good micro-simulation tool for modelling the C-Roundabout. A micro-simulation model may be able to model the C-roundabout better than SIDRA and also provide a valuable visual of its operation, to confirm that it is operating correctly and giving more confidence in the results.

Figure 2.27 is a screenshot of the S-Paramics model of the Palomino Rd/Sturges Rd C-roundabout. However, problems were encountered when attempting to model trucks taking up two lanes and preventing cars from travelling next to them in the adjacent lane on the approaches to the roundabout and through the roundabout. In the model, the available width, which means that cars need to follow trucks, is not taken into account – they continue to travel next to trucks regardless of whether there is enough space or not. Figure 2.28 illustrates this – the truck width has been exaggerated to demonstrate that cars will still travel next to a truck even if there is insufficient available lane width.

Figure 2.27 Screenshot of Palomino Dr/Sturges Rd C-roundabout modelled in S-Paramics

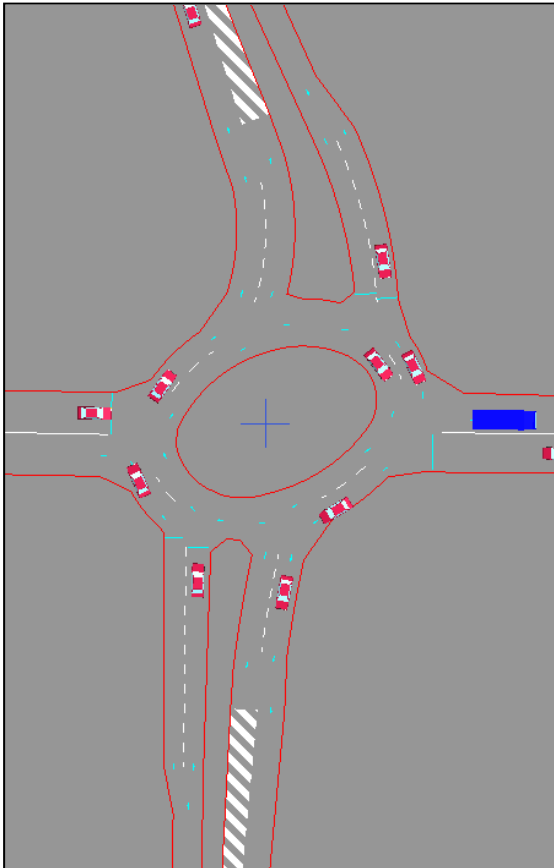
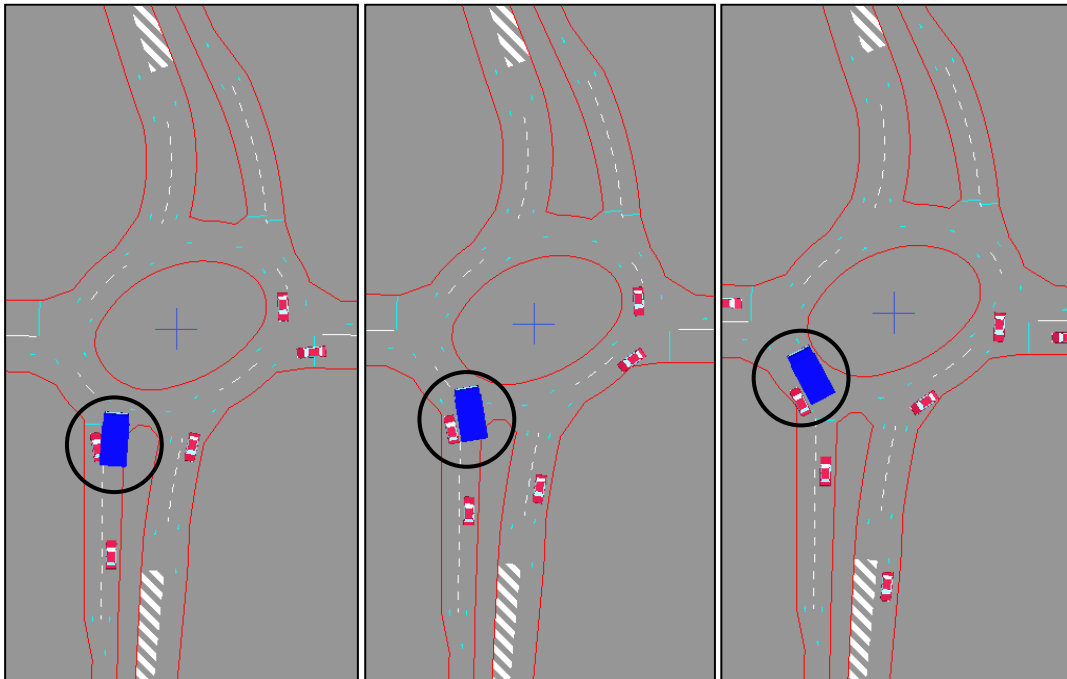


Figure 2.28 Illustration of car travelling adjacent to truck, regardless of available lane width



SIAS Paramics Support (UK) was consulted on this issue and they confirmed that the model does not take the available lane width into account, so there is no direct way of modelling the impact of the truck straddling two lanes. However, they offered two suggestions for modelling this. One suggestion was to install a signal on the approach to the roundabout with a signal plan that detects the presence of a truck and then stops cars from proceeding. We understand that this would not address the issue of trucks taking up two lanes on the roundabout itself, but this may not really be a problem, as vehicles rarely overtake on the roundabout. The other suggestion was to model temporary lane closures or restrictions. This option could be further assessed.

Another option for micro-simulation modelling of the C-roundabout is VISSIM, which may have more capabilities in modelling the trucks taking up two lanes on the roundabout approaches and through the roundabout.

There did not appear to be much difference between the videos of the on-site operation and the S-Paramics model for the peak two hours, suggesting that S-Paramics would be adequate for modelling the C-roundabout provided there was adequate capacity (degree of saturation less than 0.6) and low truck flows (less than 2.5%). If there was less capacity and truck flows were higher, an alternative simulation model may be more suitable (for example VISSIM, which appears to be able to model trucks straddling two lanes).

2.4.6.1 Recommendations for micro-simulation modelling of the C-roundabout

It is recommended that the following further research be undertaken:

- S-Paramics modelling: Assess the two solutions recommended by SIAS Paramics Support (UK) for modelling trucks straddling both lanes.
- VISSIM modelling: Assess VISSIM’s capabilities for modelling the C-roundabout, including trucks straddling both lanes.

This further research would show which micro-simulation tool would be the most appropriate for modelling the C-roundabout.

2.4.7 Impact of trucks/buses on C-roundabout approaches

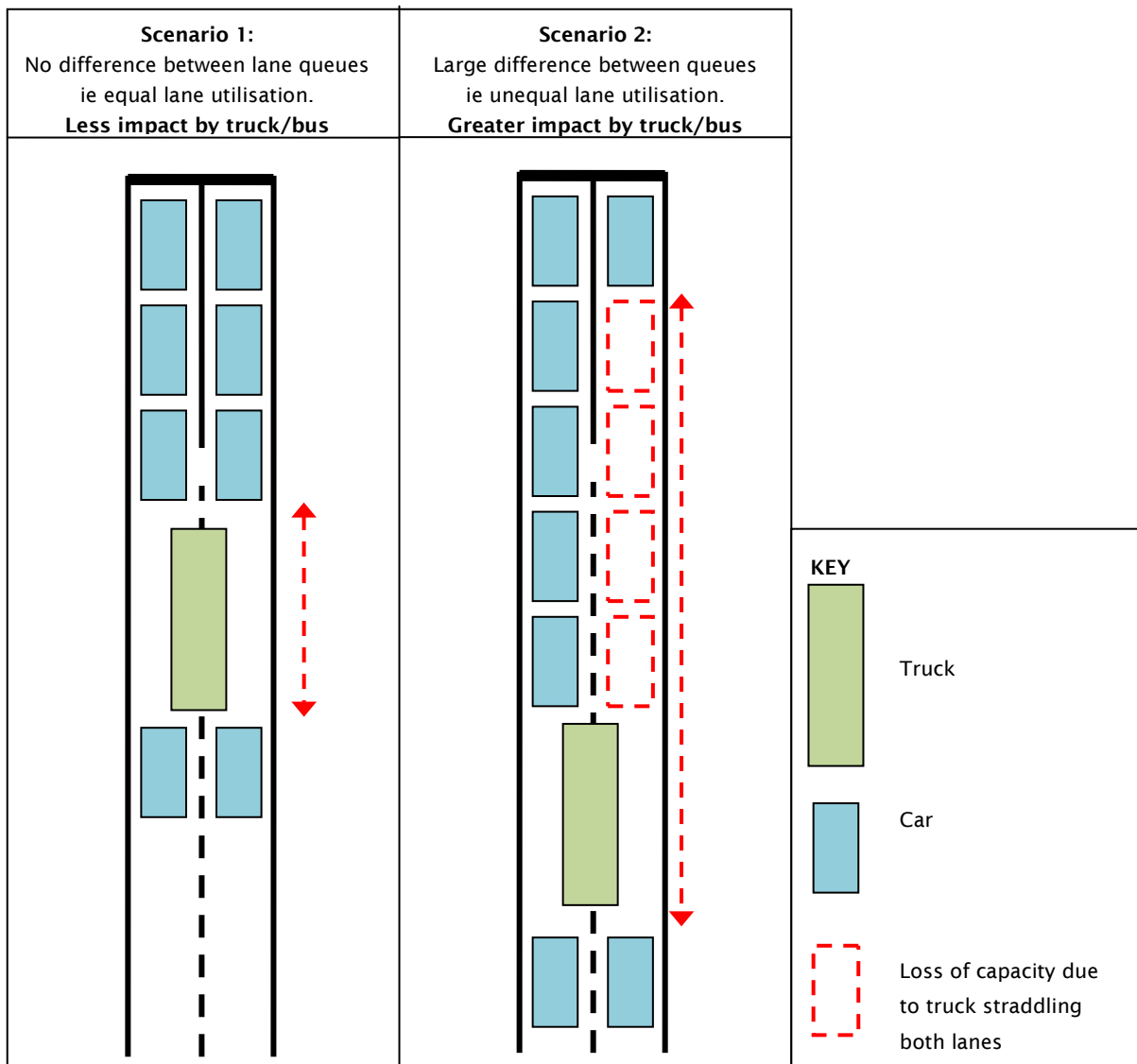
As trucks/buses are required to straddle both lanes on C-roundabout approaches, they may impact the approach capacity. The amount of impact that trucks/buses have on the capacity is expected to depend on:

- queues and lane utilisation on the approach
- the proportion of trucks/buses.

2.4.7.1 Queues and lane utilisation on approach

It was anticipated that the greater the difference between approach lane queue lengths, the greater the impact trucks/buses would have on the capacity of the approach (see figure 2.29).

Figure 2.29 Impact of truck/bus on capacity of approaches – comparison between no difference in lane queues and large difference in queues



As shown in figure 2.29, the greater the difference between approach lane queue lengths, the greater the impact trucks/buses have on the capacity of the approach. Thus, if there is low utilisation of one lane then the impact of the truck may need to be taken into account. It is considered that this may not be likely in practice unless there are very high turning volumes, as traffic equilibrium tends to equalise lane use.

As described earlier, in situations where the queue lengths are about the same, then it may be appropriate when modelling in SIDRA to approximate the impact of the trucks/buses by doubling the number of trucks. At the Palomino Dr/Sturges Rd roundabout there was little queuing on the approaches, and thus the impact of the trucks/buses was considered to be minor.

2.4.7.2 Proportion of trucks/buses

A high proportion of trucks may also negatively affect the capacity of the C-roundabout approaches. However, the number of trucks is usually low during the peak periods, which is when capacity would be of concern. The number of buses may be higher during peak periods, depending on whether the roundabout is on a bus route.

2.4.7.3 Recommendations regarding the impact of trucks/buses

It is recommended that further research be undertaken to confirm the amount of impact trucks/buses would have on the capacity if there is a large difference between approach lane queues. It is recommended that a site with this issue be studied (eg Parrs Cross Rd/Seymour Rd).

2.4.8 Summary regarding the capacity of the C-roundabout

- The installation of the C-roundabout at this uncongested site had little impact on capacity (based on SIDRA and on-site measurements of the operation).
- The capacity implications of converting an existing multi-lane roundabout into a C-roundabout were difficult to assess at the Palomino Dr/Sturges Rd site because of low traffic flows, very little queuing and stop-line delay, and very few congested periods (only 13 minutes in both peak periods).
- **SIDRA modelling:**
 - For an uncongested roundabout, SIDRA indicates that converting an existing multi-lane roundabout into a C-roundabout has very little impact on the delay, the degree of saturation and the design life.
 - SIDRA calculates a small increase in the critical gap and follow-up headway due to the geometry of the C-roundabout. This could not be confirmed by on-site measurements (gap and follow-up headway) because of insufficient congested periods.
 - Trucks/buses at the Palomino Dr/Sturges Rd C-roundabout did not significantly impact the approach capacity because of the low percentage of trucks/buses and little queuing on the two-lane approaches.
- **On-site observation and measurements – regression analysis:**
 - There was insufficient data to statistically conclude whether the capacity of the Palomino Dr/Sturges Rd C-roundabout was better or worse than the previous roundabout from the on-site measurements.
 - The measurements of the entry flow and circulating flow suggested a drop in capacity for the C-roundabout design when the circulating flows were less than 878veh/hr and an increase in capacity when circulating flows were greater than 878veh/hr – although the R^2 (coefficient of

determination) value indicated that the regression equation for the entry flow to circulating flow was not a good fit ($R^2 < 0.5$).

- Trucks and buses did not have an adverse impact on the capacity of the Palomino Dr/Sturges Rd C-roundabout (low percentage of trucks/buses).
- Further sites would need to be reviewed before conclusive results could be obtained.

- **Delay measurements:**

- Converting the multi-lane roundabout to a C-roundabout had no significant impact on the delays.

2.4.8.1 Impact of trucks/buses on C-roundabout approaches:

As trucks/buses are required to straddle both lanes on C-roundabout approaches (blocking access to one lane), they may impact the approach capacity. However they are unlikely to have a significant impact, as heavy-vehicle numbers are usually low in peak periods.

The amount of impact that trucks/buses have on capacity is expected to depend on the following factors:

- Queues and lane utilisation on the approach – the greater the difference between approach-lane queue lengths, the greater the impact trucks/buses would have on the capacity of the approach. Thus, if there is low utilisation of one lane then the impact of the truck/bus would need to be taken into account, particularly if there was a high volume of turning traffic (traffic equilibrium tends to equalise lane use).
- Proportion of trucks/buses – the higher the proportion of trucks/buses, the more likely they will negatively impact the capacity of the approach.

2.4.8.2 S-Paramics modelling of C-roundabout:

- The C-roundabout can be modelled in S-Paramics, except difficulties were encountered in modelling the trucks straddling both lanes. Solutions to overcome this problem were suggested by SIAS Paramics Support (UK), but further research would be needed to confirm whether these methods would be appropriate.
- There did not appear to be much difference between the videos of the on-site operation and the S-Paramics model for the peak two hours, suggesting that S-Paramics would be adequate for modelling the C-roundabout provided there was adequate capacity (degree of saturation less than 0.6) and low truck flows (less than 2.5%). If there was less capacity and truck flows were higher, an alternative simulation model such as VISSIM may be more suitable.

2.4.9 Further research for assessing the capacity of the C-roundabout

It is recommended that following further research be undertaken:

- Determine whether the critical gap and follow up headways calculated by SIDRA are correct for the C-roundabout situation. Two new C-roundabouts have since been constructed in Auckland at more congested sites and these could be used to obtain more conclusive results.
- Undertake further entry flow and circulating flow measurements at a C-roundabout with higher flows and with more periods of congestion. The two new C-roundabouts in Auckland could be studied. This will enable a stronger relationship between entry and circulating flow to be established and thus evaluate the capacity of the C-roundabout using regression analysis.
- Determine whether doubling of the truck numbers on the C-roundabout approaches in SIDRA modelling is a reasonable method to approximate their impact on capacity, as long as there is not

significant queuing on the approaches. To do this the author of SIDRA should be consulted, and further on-site observations should be undertaken at C-roundabouts that have higher traffic flows.

- Micro-simulation modelling:
 - S-Paramics modelling: Assess the two solutions for modelling trucks straddling both lanes recommended by SIAS Paramics Support (UK).
 - VISSIM modelling: Assess VISSIM’s capabilities for modelling the C-roundabout including trucks straddling both lanes.

From the above further research, a conclusion could be made as to which micro-simulation tool is the most appropriate for modelling the C-roundabout.

- Investigate the impact trucks/buses have on capacity where there is a large difference between approach lane queues in congested conditions. It is recommended that a site with this issue be studied (for example Parrs Cross Rd/Seymour Rd).

2.5 Road users’ impressions of the Palomino Dr/Sturges Rd C-roundabout

Surveys were undertaken to assess the cyclists’, pedestrians’, car drivers’ and local residents’ impressions of the Palomino Dr/Sturges Rd C-roundabout.

2.5.1 Cyclist survey

2.5.1.1 Introduction

As the intention of the C-roundabout is to primarily cater for cyclists, their opinion of the C-roundabout is important.

This survey was conducted by emailing a questionnaire form to Cycle Action Auckland (CAA), who forwarded it to all their members. It was also sent to cyclists at the previous Waitakere City Council. The questionnaire form asked the cyclists to cycle through the Palomino Dr/Sturges Rd C-roundabout, complete the questionnaire and return it via email. A prize was included as an incentive for people to go out of their way to visit the roundabout.

The questionnaire was designed to obtain cyclists’ opinions on the perceived safety of the C-roundabout, the ease of use and the design of the signs and road markings. A copy of the questionnaire is included in appendix B.

The total number of survey respondents was 14.

A summary of the survey questions and responses is given in the following sections.

2.5.1.2 Survey questions

- *Questions 1–4 – Cycling experience:* The first four questions of the survey were designed to determine the respondents’ normal purpose for cycling, their level of competence, how frequently they cycled and how familiar they were with cycling through roundabouts. A summary of the results is given below.

Figure 2.30 Question 1 – Purpose of cycling

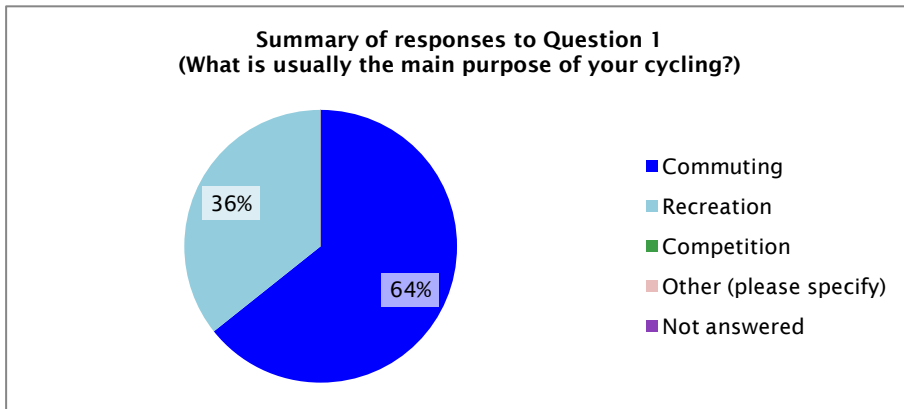


Figure 2.31 Question 2 – Level of competence

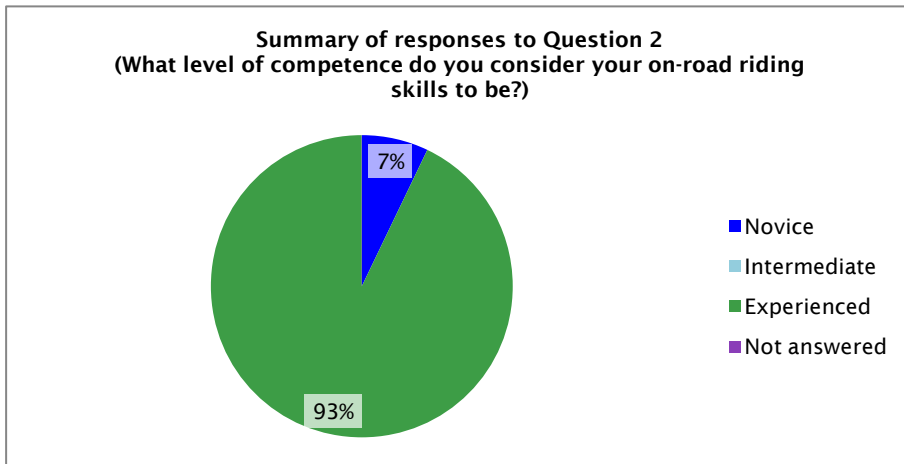


Figure 2.32 Question 3 – Frequency of cycling

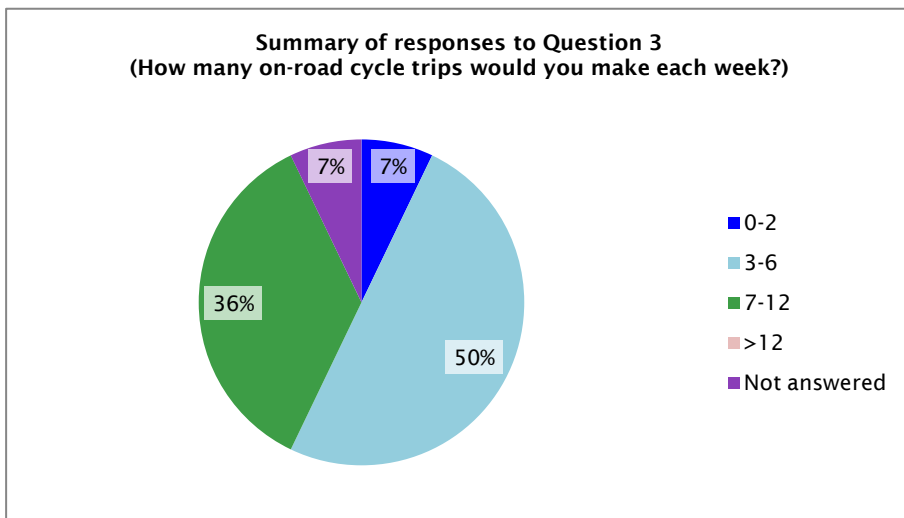
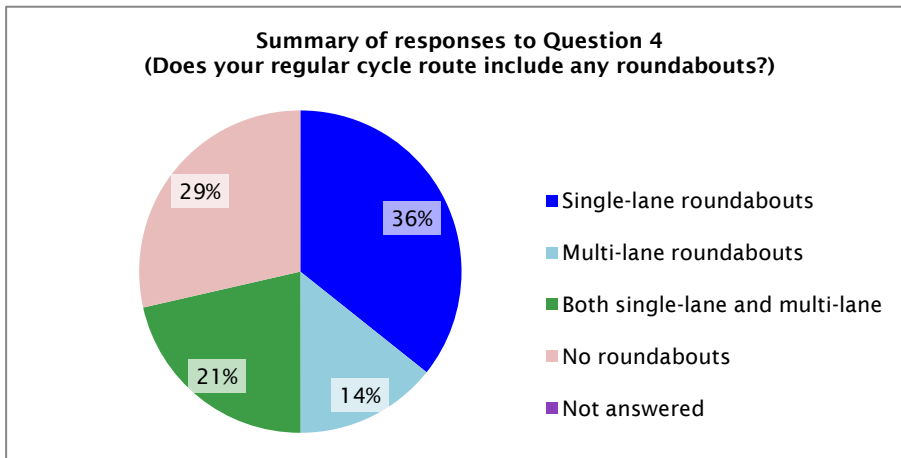


Figure 2.33 Question 4 – Familiarity with cycling through roundabouts



- *Questions 5–6 – Site conditions:* The cyclists were asked what time of day they visited the Palomino Dr/Sturges Rd C-roundabout and what the weather condition was.

Figure 2.34 Question 5 – Time of day

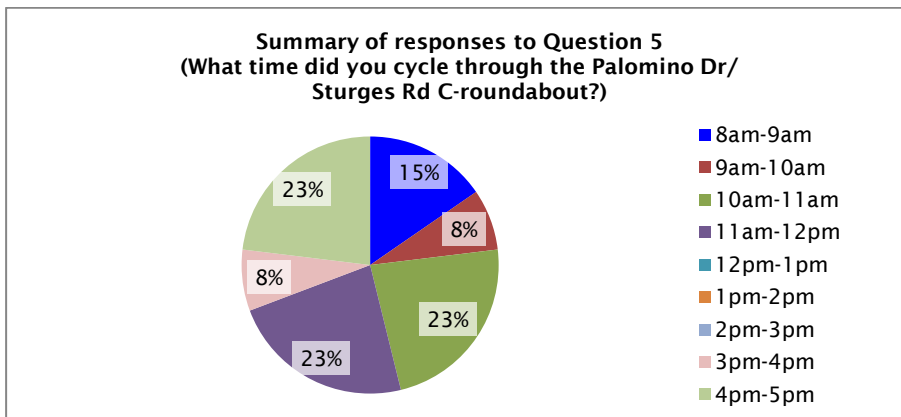
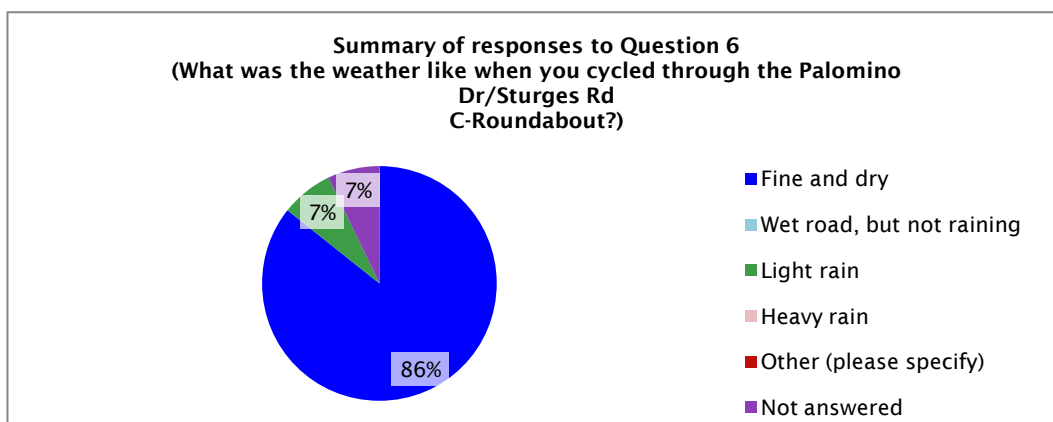


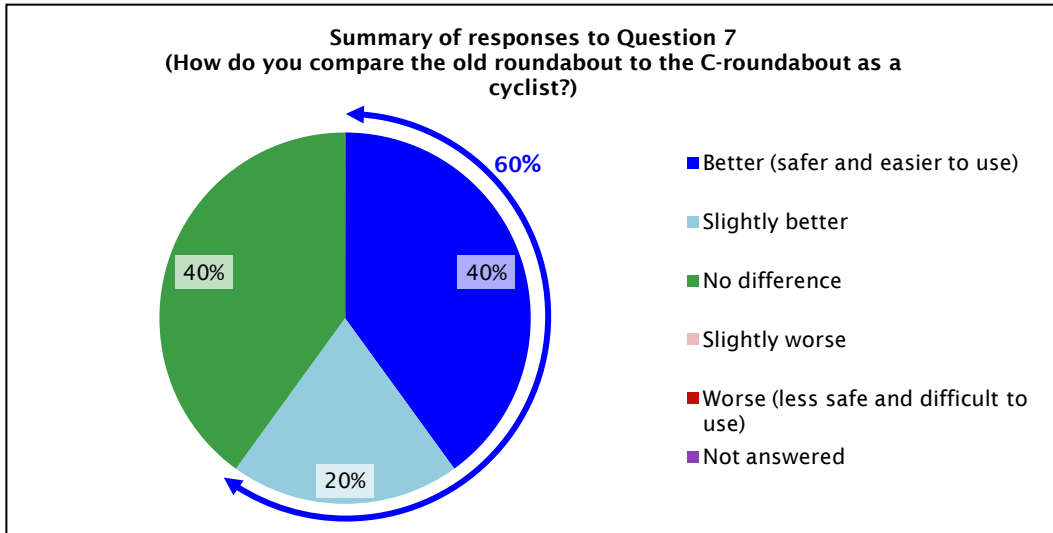
Figure 2.35 Question 6 – Weather conditions



- *Question 7 – Comparison between previous roundabout and new C-roundabout:* The respondents were asked if they had in the past cycled through the old Palomino Dr/Sturges Rd roundabout, before it was converted to the C-roundabout design. The 36% of respondents who had were then asked how the

new C-roundabout compared with the previous roundabout. The response was largely positive; 60% said it was better for cyclists than previous roundabout, and none of the respondents felt that the C-roundabout design was worse (see figure 2.36).

Figure 2.36 Question 7 – Comparison of the new C-roundabout with the previous one



- Question 8 – Cyclists' impressions of ease of use, safety and car speed at C-roundabout:** Respondents were asked if they had cycled through other multi-lane roundabouts before. The 93% of respondents who had were then asked how they compared the C-roundabout with other multi-lane roundabouts in terms of ease of use of roundabout, safety of roundabout, and the speed of cars on the roundabout. The results are shown in the figures below. The response was largely positive; 69% thought it was easier for cyclists to use than other roundabouts; 77% thought it was safer for cyclists; 53.9% thought car speeds were lower; none of the respondents thought the C-roundabout design was worse.

Figure 2.37 Question 8 (i) – Ease of use for cyclists

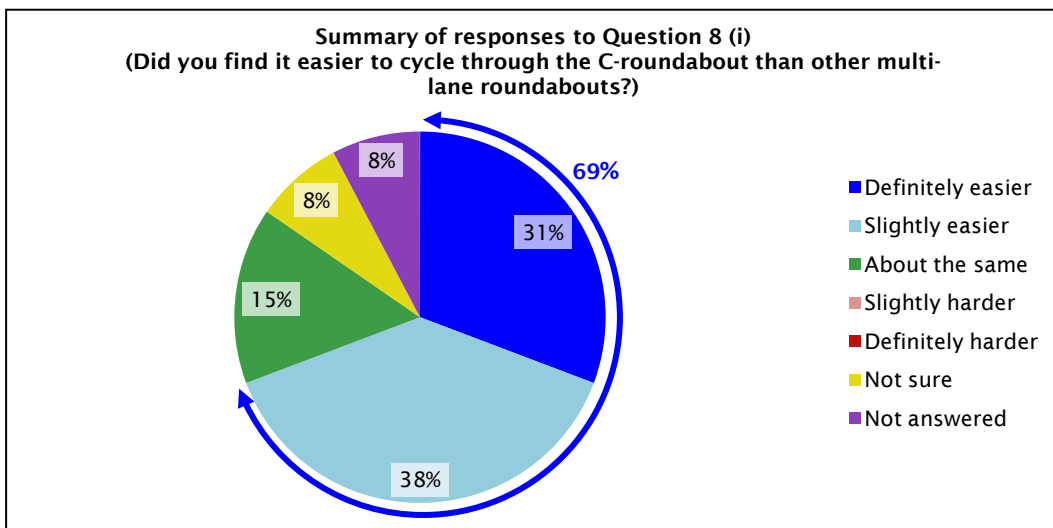


Figure 2.38 Question 8 (ii) – Cyclists’ impressions of safety

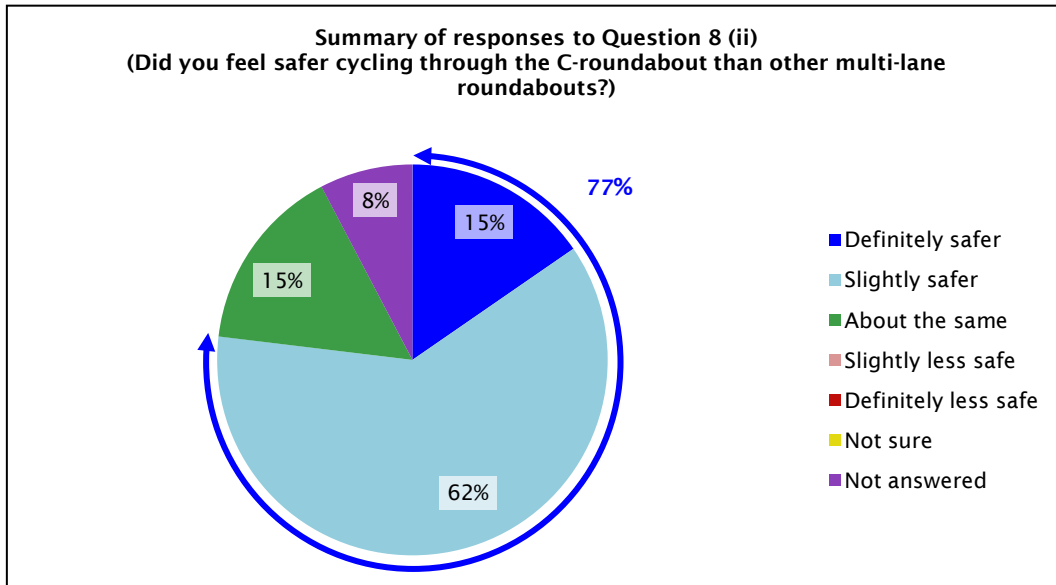
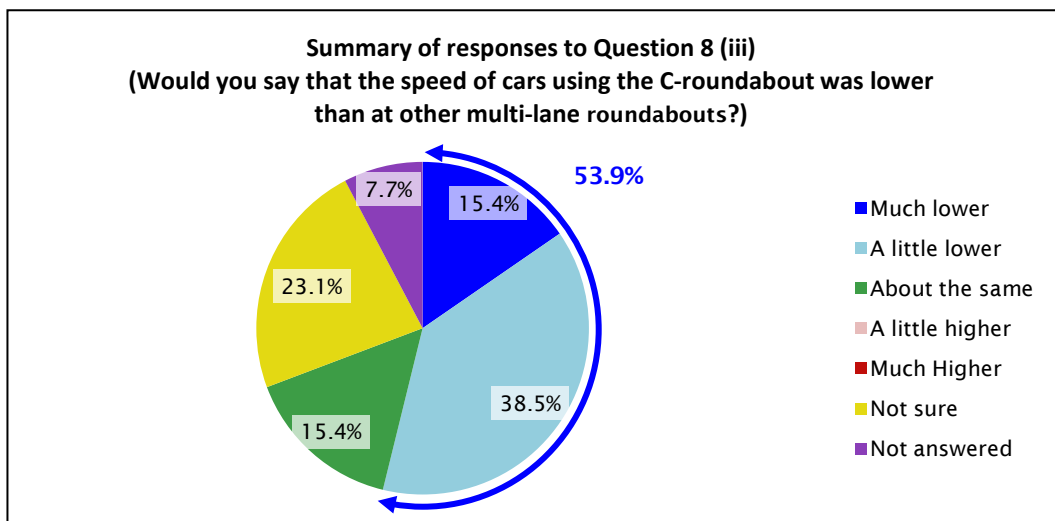
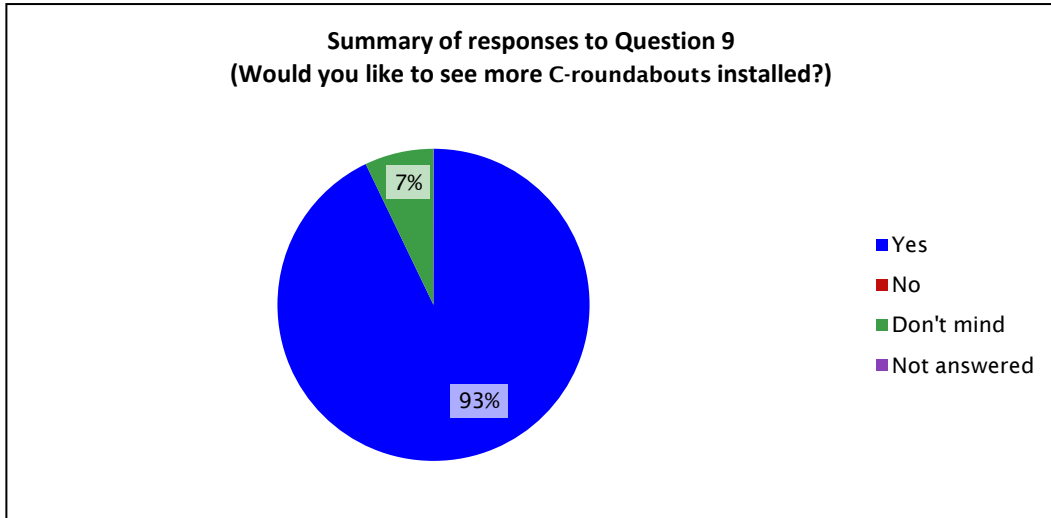


Figure 2.39 Question 8 (iii) – Cyclists’ impressions of car speed



- *Question 9 – Do cyclists want to see more C-roundabouts installed:* There was a very positive response to this question – 93% (13 out of 14 respondents) answered ‘Yes’; 7% (1 out of 14 respondents) answered ‘Don’t mind’; and none answered ‘No’.

Figure 2.40 Question 9 – Popularity of C-roundabouts



- Question 10 – Road markings and signage:* The cyclists were asked whether they thought the road markings and signs installed at the roundabout helped them to use the C-roundabout. They were then asked if the road-marking cycle symbols (as shown in figure 2.41 below) communicated to them that they should cycle in the centre of the lanes, as though they were a car. They were also asked whether they understood that the truck lane-use sign (as shown in figure 2.42) is to inform the trucks to straddle (take up) both lanes. Seventy-one percent (71%) thought the road markings and signs were helpful. However, the cycle symbol road marking did not adequately communicate to cyclists to cycle in the centre of the lanes – for 57% of the cyclists the road marking was *unsuccessful* in communicating to them to cycle in the middle of the lane (29% said ‘No’, 14 % said they were unsure and 14% did not notice the road markings). Only 43% said that the road marking adequately communicated to them to cycle in the centre of the lanes. The truck lane-use sign was generally understood – of the cyclists who saw the sign, the majority thought the sign adequately communicated that trucks are supposed to straddle both lanes.

Figure 2.41 Cycle symbol road markings installed on northern and southern approaches to the Palomino Dr/Sturges Rd C-roundabout⁵

⁵ Non-standard signs and markings, which do not comply with the Land Transport Rule: Traffic Control Devices (TCD Rule), have been used in undertaking this research. Refer to page 3 of this report.

Figure 2.42 Truck lane-use sign installed on northern and southern approaches to the Palomino Dr/Sturges Rd C-roundabout



Figure 2.43 Question 10 – Usefulness of road markings and signs

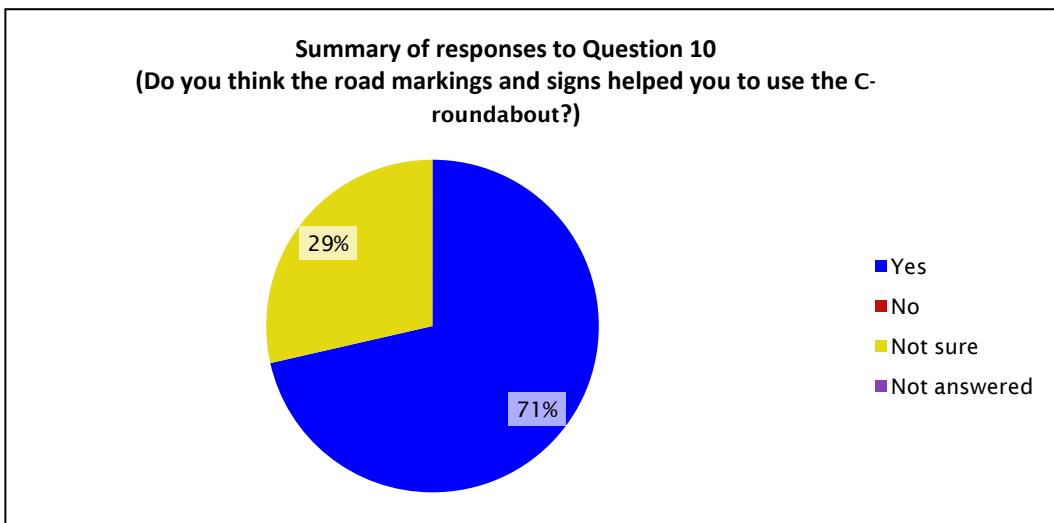


Figure 2.44 Question 11 – Cycle symbol road markings

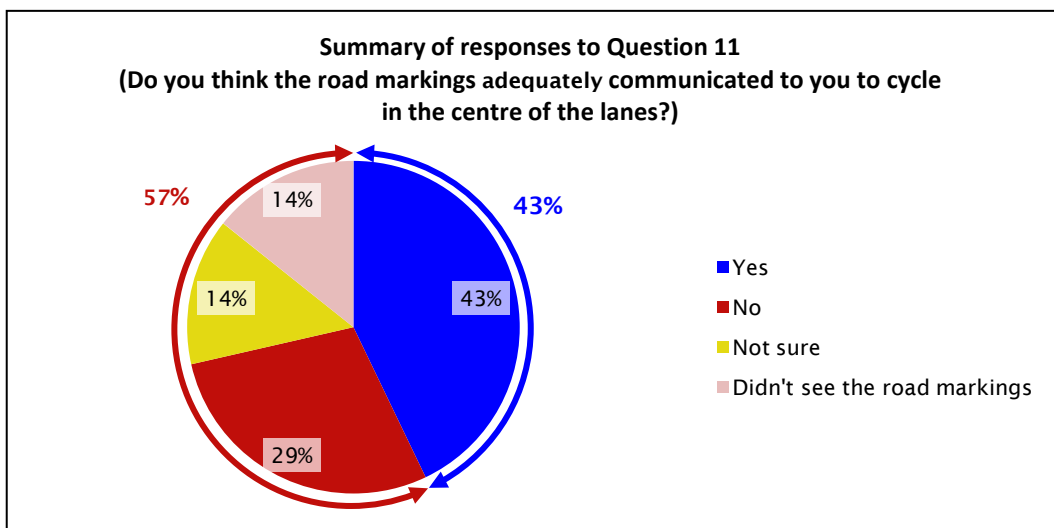
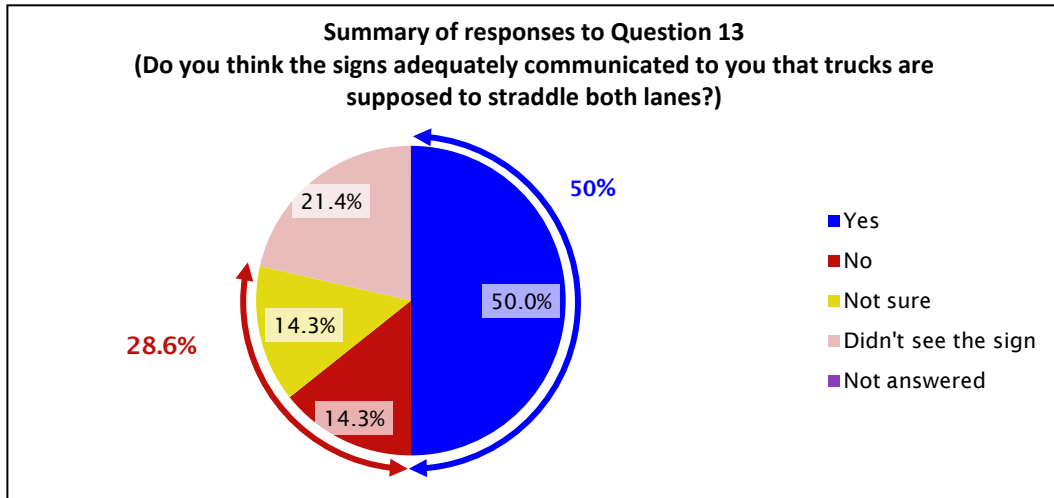


Figure 2.45 Question 13 – Truck lane-use sign



2.5.2 Pedestrian survey

2.5.2.1 Introduction

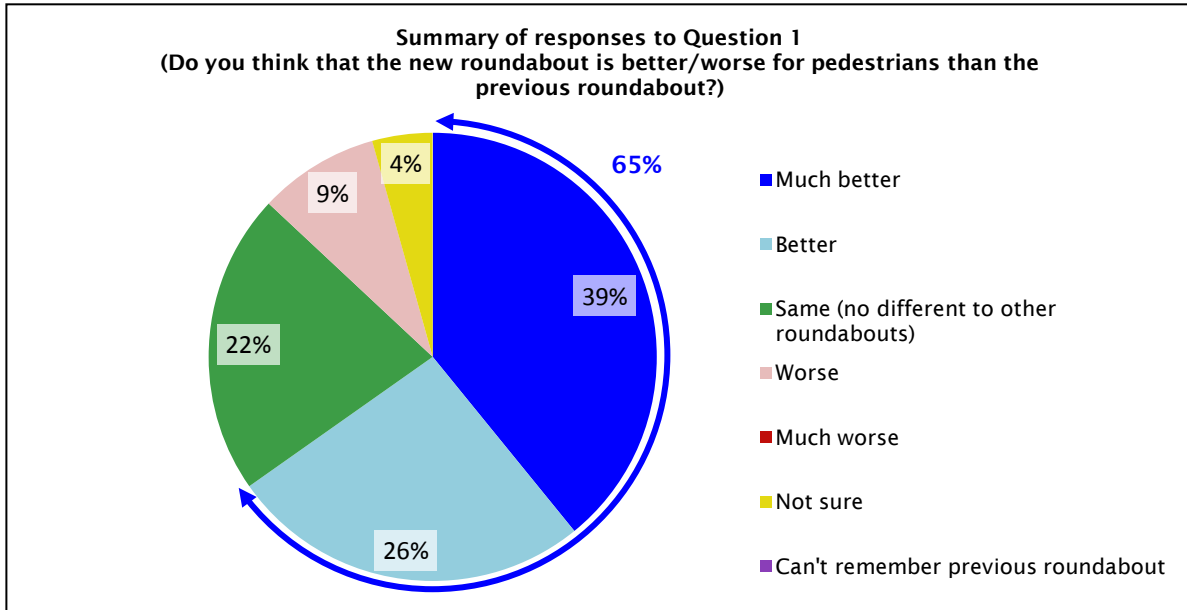
A survey to assess pedestrians' opinions regarding the perceived safety and ease of use of the Palomino Dr/Sturges Rd C-roundabout for pedestrians was undertaken on 17 June 2010 (Thursday). An information sheet and questionnaire form (see appendix C) was handed out to 100 pedestrians at the roundabout. We received 23 responses, ie a 23% response rate.

A summary of the pedestrian survey questions and responses is given in the following sections.

2.5.2.2 Survey questions

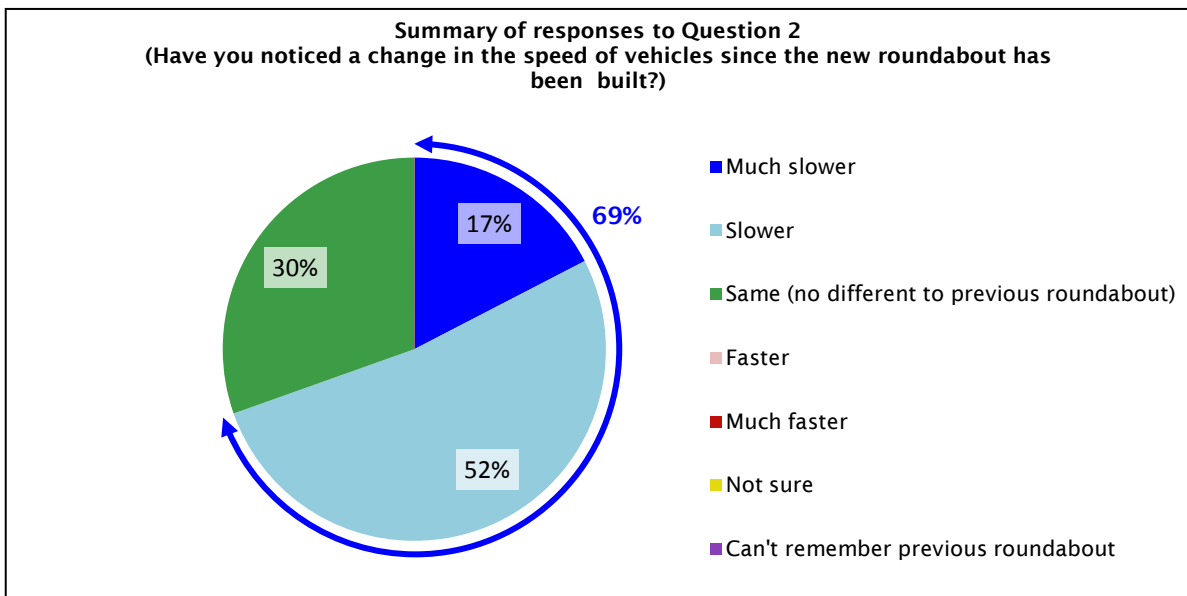
- *Question 1 – Comparison between the previous roundabout and the new C-roundabout:* Pedestrians were asked whether they thought the new C-roundabout was better or worse for pedestrians than the previous roundabout. The response was positive, with the majority of pedestrians (65%) responding that the C-roundabout was better for pedestrians, and 39% thought it was 'Much better'.

Figure 2.46 Question 1 – Comparison of the previous roundabout and the new C-roundabout



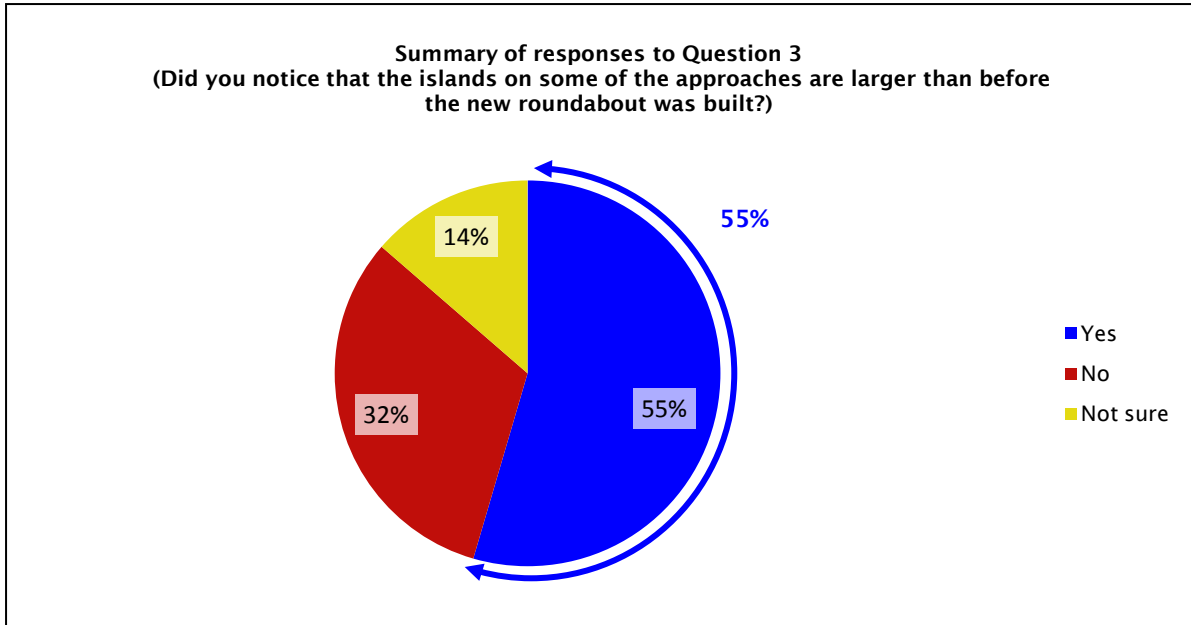
- *Question 2 – Pedestrian impression of car speed:* The pedestrians were asked whether they noticed a change in the speed of vehicles at the roundabout. The response was positive, with the majority of pedestrians (69%) responding that the car speeds were slower; 17% thought they were ‘Much slower’ and none thought they were faster.

Figure 2.47 Question 2 – Pedestrians’ impression of vehicle speeds



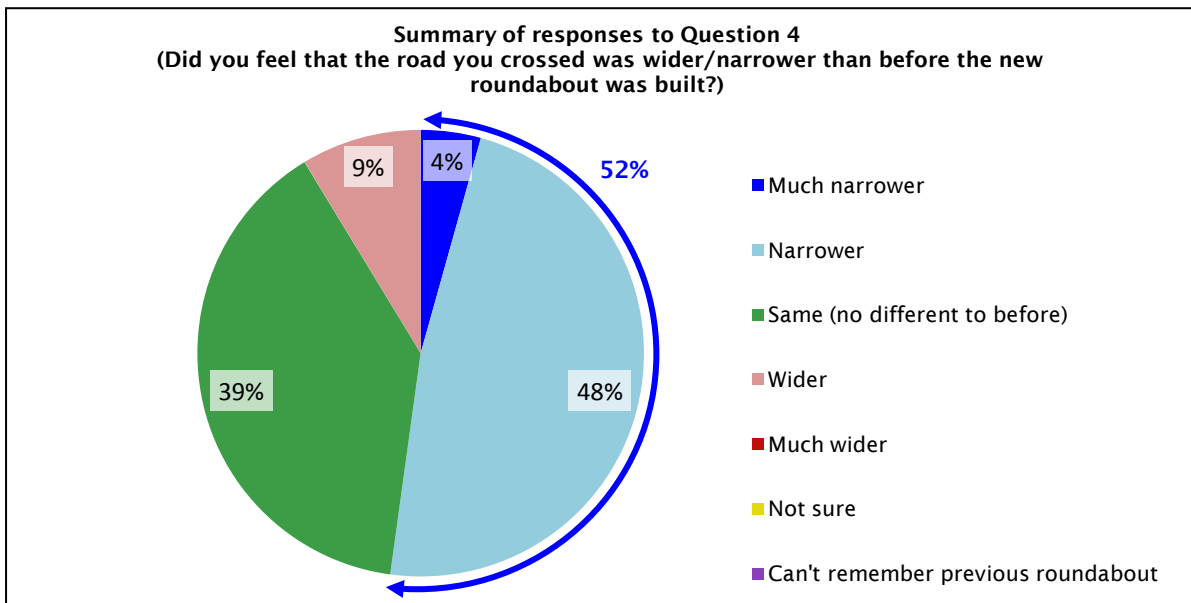
- *Question 3 – Pedestrians’ impressions of the size of the traffic islands:* The pedestrians were asked if they noticed that the traffic island on some of the roundabout approaches had been made larger. The majority of the pedestrians (55 %) had noticed that they were larger.

Figure 2.48 Question 3 – Size of traffic islands



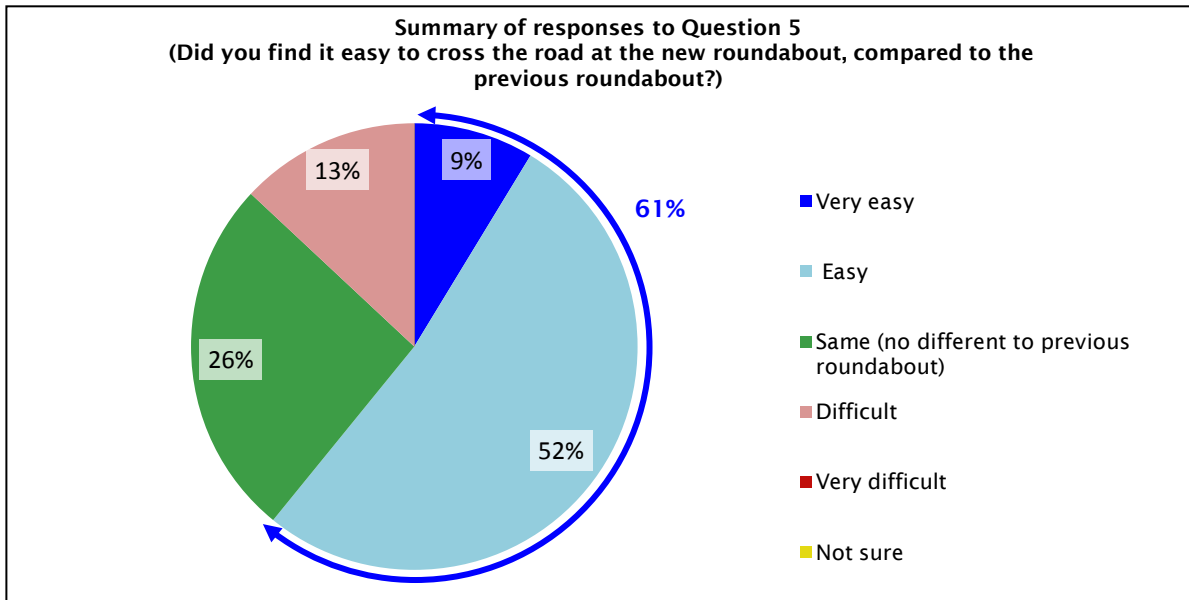
- *Question 4 – Pedestrians' impressions of width of approaches:* In this question, the intention was to identify whether the pedestrians noticed that they had a shorter crossing distance, which is safer for pedestrians. It was found that about half of the pedestrians (52%) had noticed that the road was narrower.

Figure 2.49 Question 4 – Crossing distance



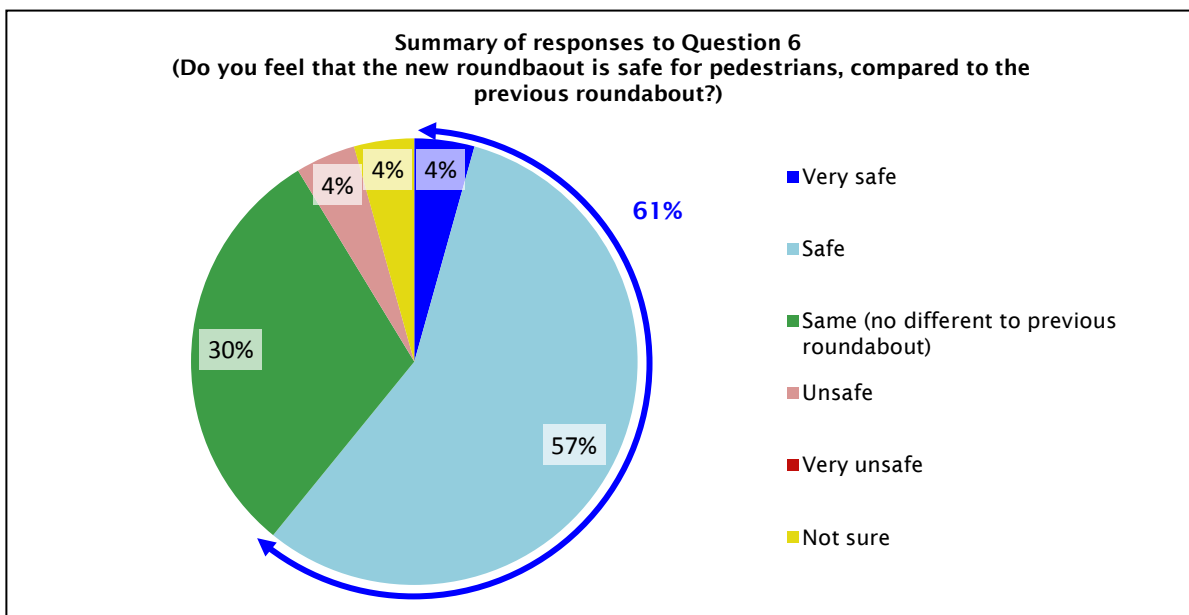
- *Question 5 – Ease of crossing the road:* The pedestrians were asked how easy it was to cross the road at the new C-roundabout compared with the previous roundabout. The response was positive, with the majority of pedestrians responding that it was easy to cross (61%) compared with the previous roundabout, and only 13% saying it was difficult.

Figure 2.50 Question 5 – Ease of crossing the road



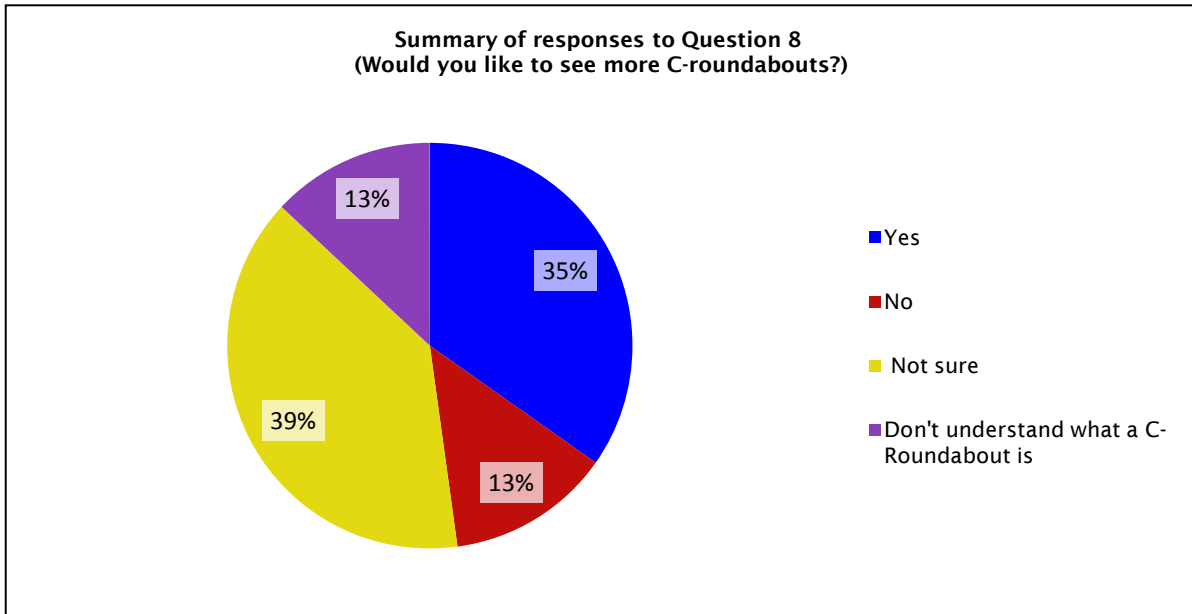
- *Question 6 – Pedestrians’ impression of safety of C-roundabout:* The pedestrians were asked whether they thought the new C-roundabout was safe for pedestrians compared with the previous roundabout. The majority of pedestrians (61%) thought it was.

Figure 2.51 Question 6 – Pedestrians’ impression of safety



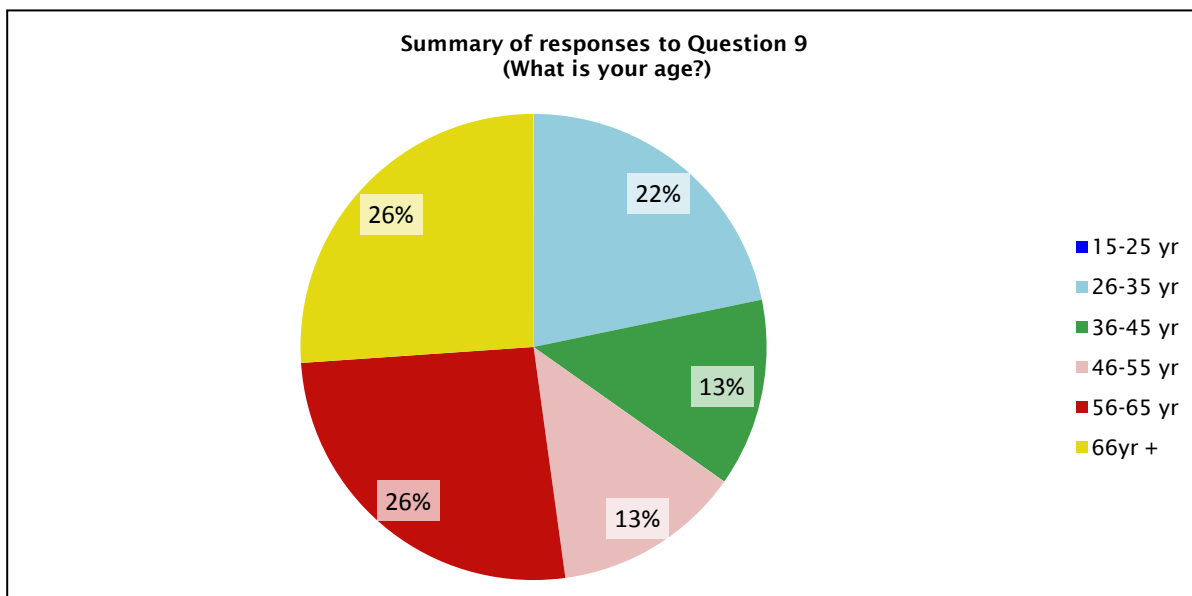
- *Question 8 - Do pedestrians want to see more C-roundabouts installed?* Thirty-five percent of the pedestrians (8 out of 23) wanted to see more C-roundabouts installed, and only 13% (3 out of 23) did not want to see more C-roundabouts installed.

Figure 2.52 Question 8 - Would you like to see more C-roundabouts?



- *Question 9 - Age and gender of respondents:* The age distribution of the respondents is shown in the graph below. There were 9 male respondents and 11 female respondents, and 3 respondents who did not specify whether they were male or female.

Figure 2.53 Respondent Age of respondents



2.5.3 Car driver survey

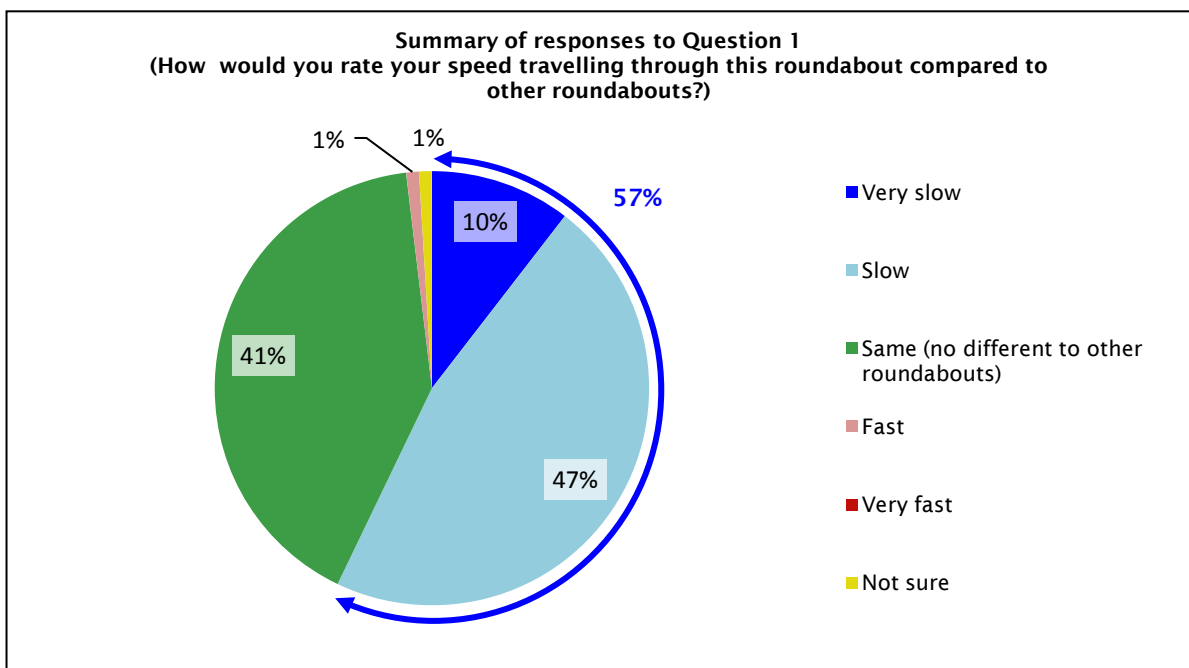
2.5.3.1 Introduction

A survey of car drivers was undertaken to assess their opinions of the Palomino Dr/Sturges Rd C-roundabout. Truck and bus drivers were excluded. The survey involved collecting a sample of car number plates for vehicles travelling straight through the roundabout from the southern and northern approaches (which were the two-lane approaches). The car owners' details were then obtained via Motochek (NZTA's database). An information sheet and questionnaire was then posted to the car owners (see appendix D for a copy). The survey was sent to 379 car drivers and 104 responded, ie a 27% response rate.

2.5.3.2 Survey questions

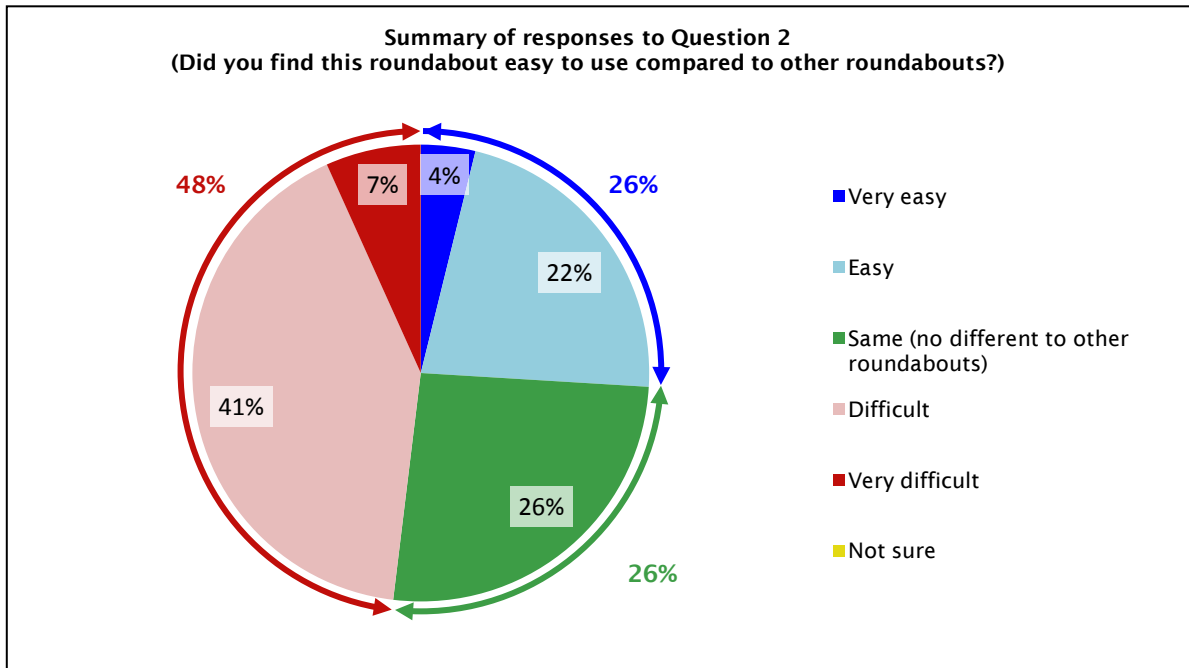
- *Question 1 – Impression of speed at C-roundabout:* The majority of the car drivers (57%) thought their speed when travelling through the C-roundabout was 'slow' compared with other roundabouts.

Figure 2.54 Question 1 – Car drivers' impressions of their speed



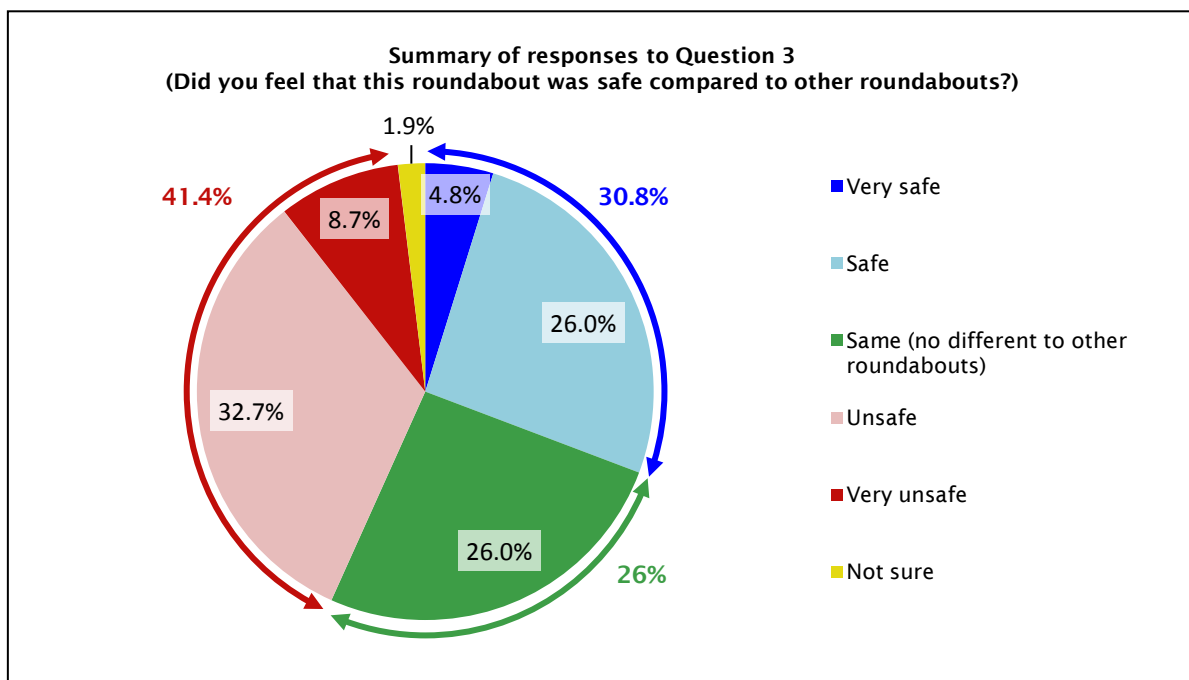
- *Question 2 – Ease of use of C-roundabout for car drivers:* Approximately half the car drivers (52%) found this roundabout 'easy' or 'the same' to use as other roundabouts; 48% found it 'difficult' to use compared with other roundabouts.

Figure 2.55 Question 2 – Ease of use for car drivers



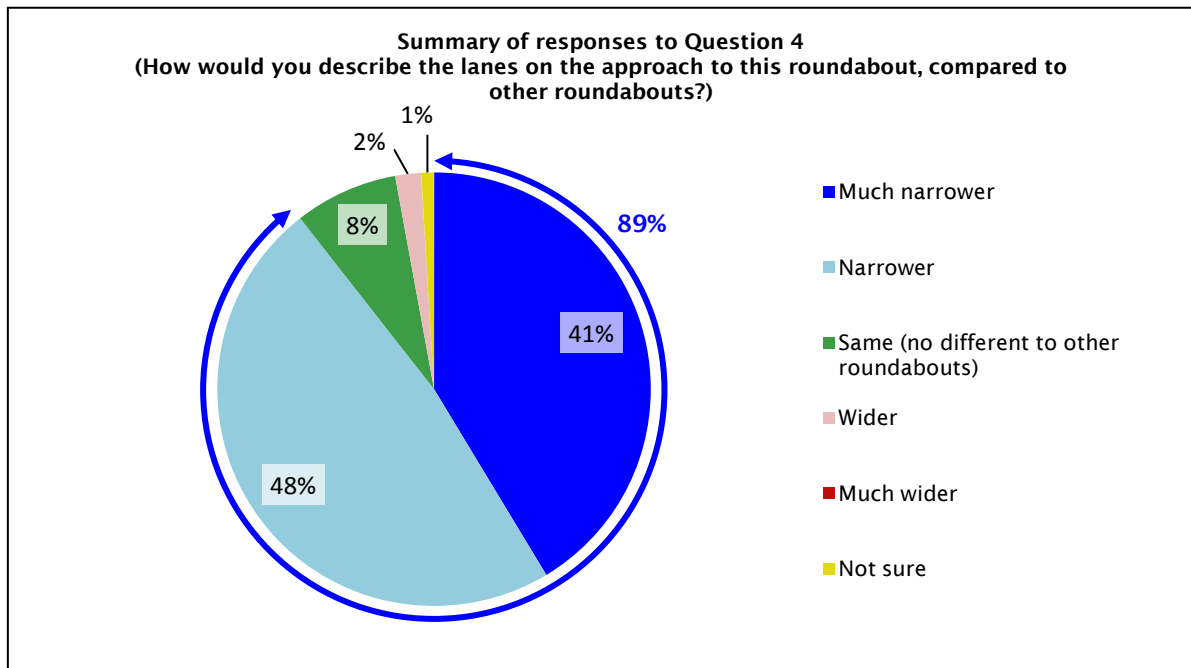
- *Question 3 – Car drivers’ impressions of the safety of the C-roundabout:* A significant proportion of the drivers (41.4%) thought that the C-roundabout was unsafe, in comparison with other roundabouts. However the results of the crash analysis did not confirm this perception, as crashes had not increased since the installation of the Palomino Dr/Sturges Rd C-roundabout. Over half the drivers (56.8%) thought this roundabout was ‘safe’ or ‘the same as other roundabouts’.

Figure 2.56 Question 3 – Car drivers’ impressions of the safety of the C-roundabout



- *Question 4 – Width of lanes:* The majority of car drivers (89%) thought the lanes were ‘narrower’.

Figure 2.57 Question 4 – Width of lanes



- *Questions 5 and 6 – Truck lane-use sign:* Questions 5 and 6 were related to the truck lane-use sign installed on the northern and southern approaches (refer to figure 2.42 for a photo). The respondents were first asked if they noticed the sign, and then what they thought the sign meant. The majority of car drivers (83%) noticed the truck lane-use sign, and 88% understood that it meant that trucks should straddle both lanes, but only 27% understood that cars should stay behind trucks.

Figure 2.58 Question 5 – Did you notice the truck sign on the approach?

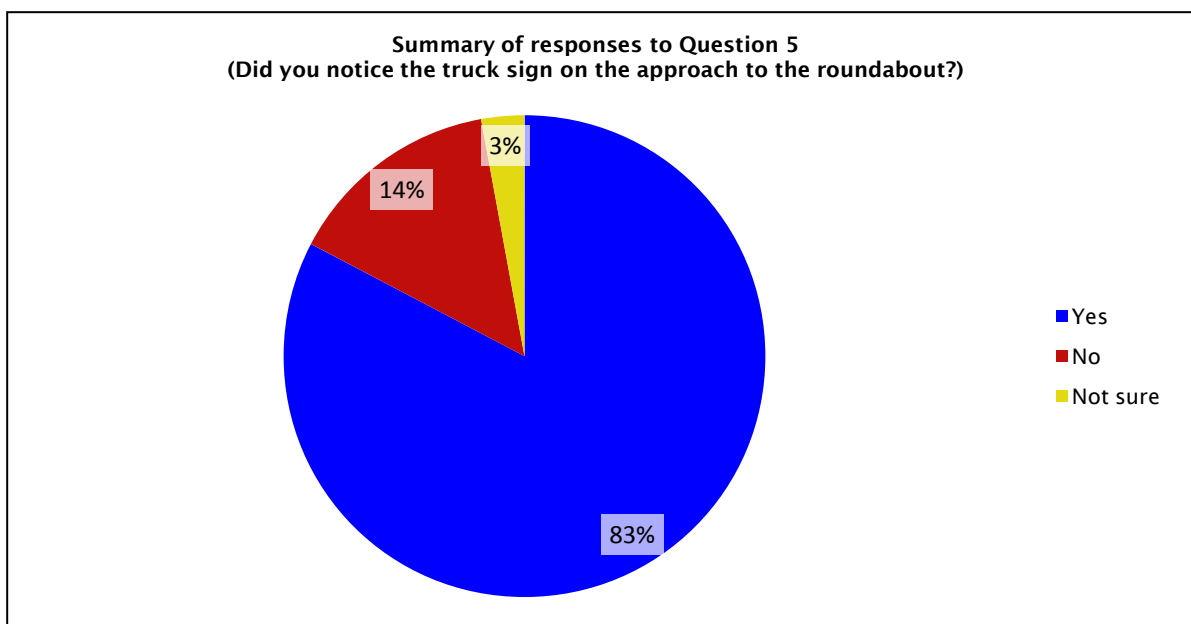
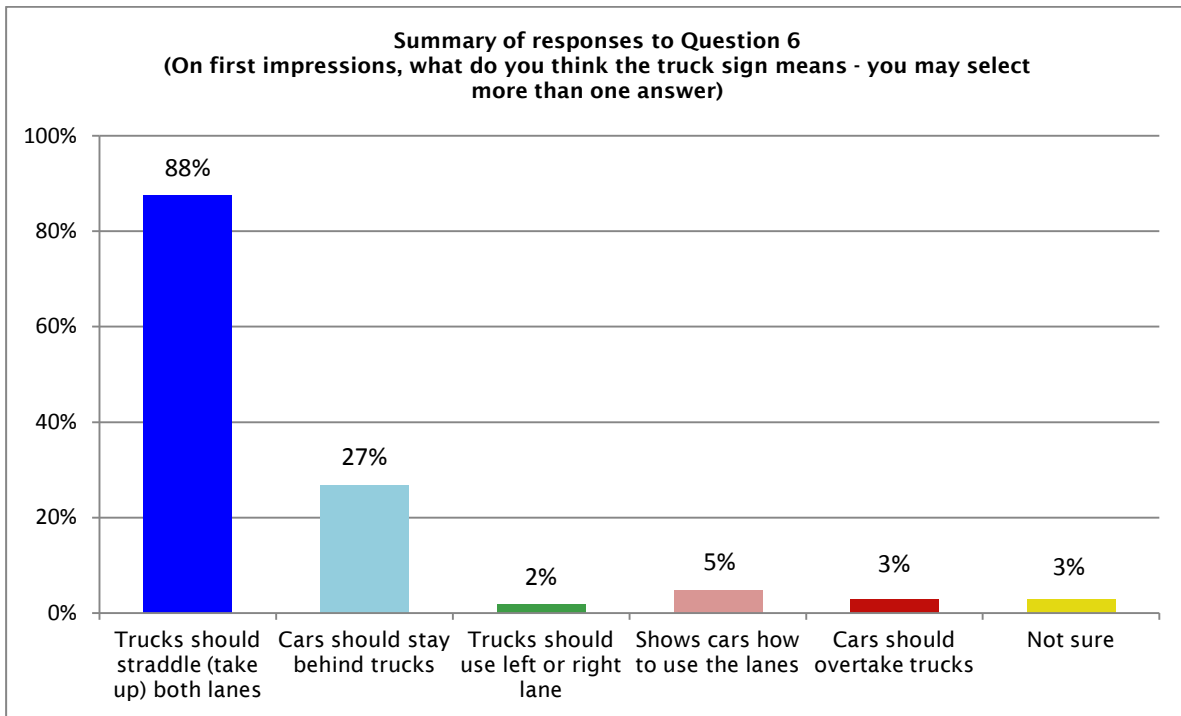


Figure 2.59 Question 6 - Car drivers' interpretations of sign



- *Question 7 - Alternative truck lane-use sign design:* In question 7 an alternative sign design (see figure 2.61) was presented and the respondents were asked to state their preference, given the intended meaning of the sign (ie that large trucks and buses should straddle both lanes and cars should stay behind them).

The majority of car drivers (67%) thought the existing truck lane sign (ie sign no. 2) was better.

Figure 2.60 Question 7 - Alternative truck lane-use sign design preference

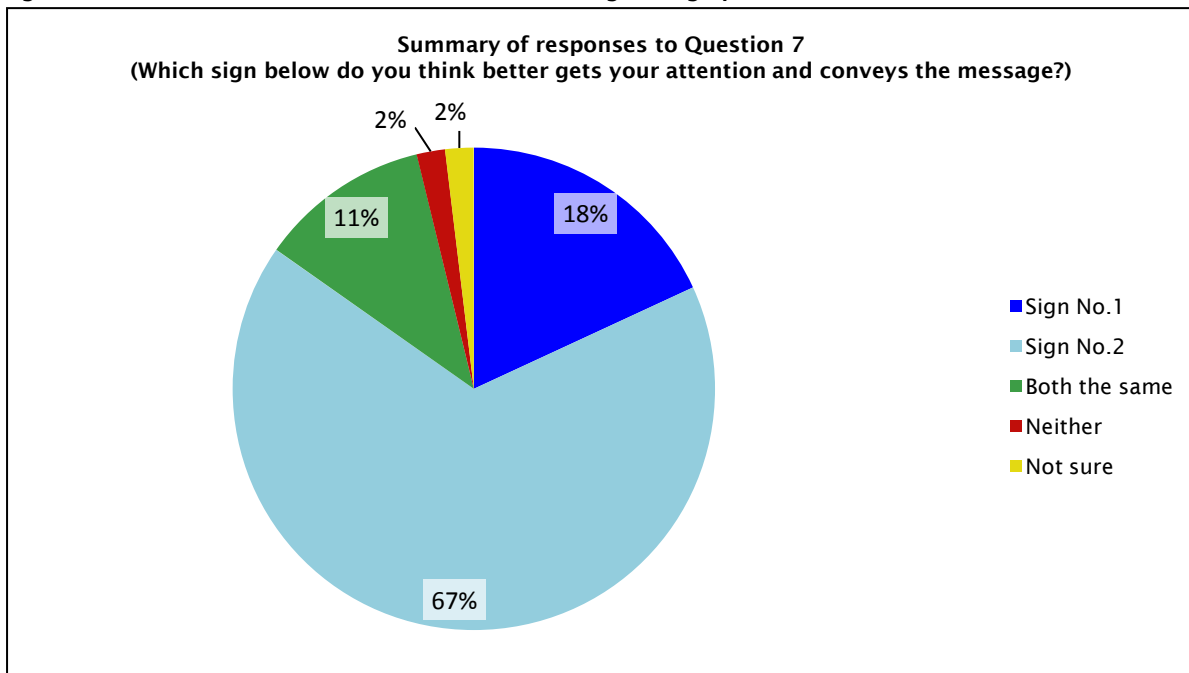
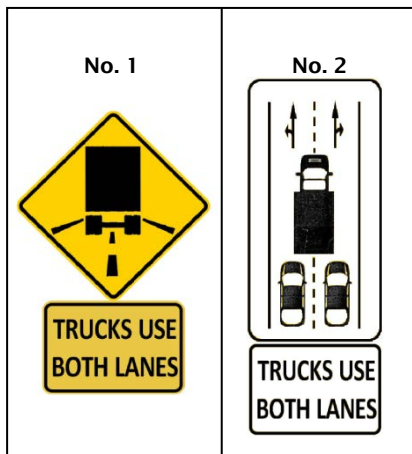
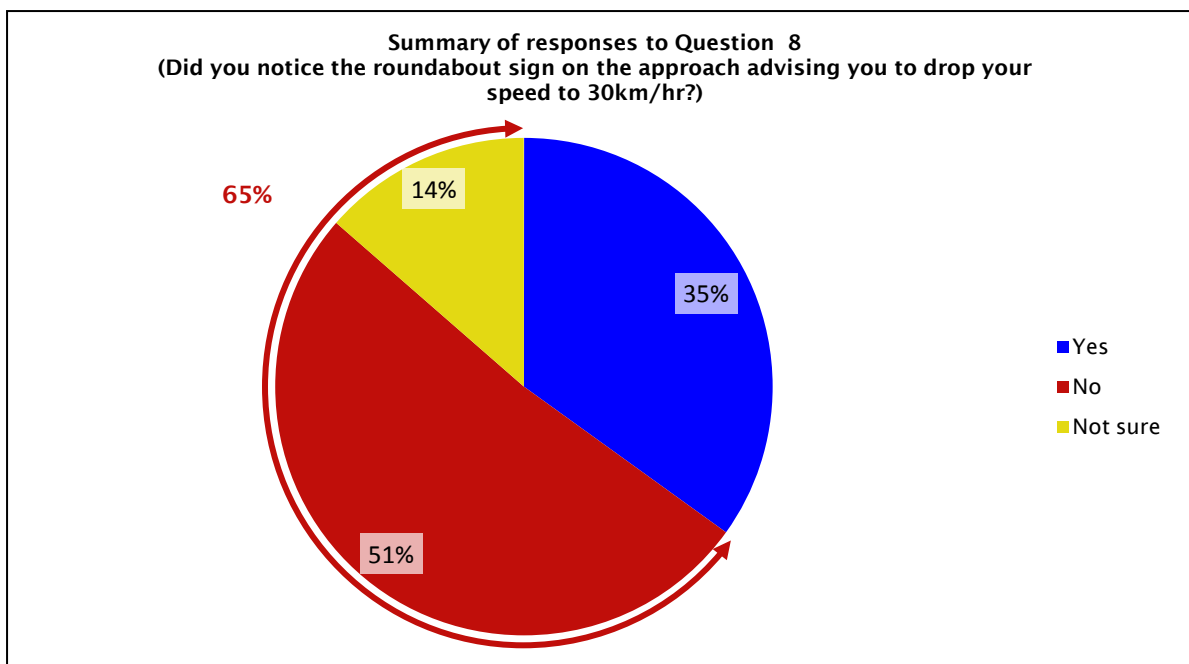


Figure 2.61 Truck lane-use sign options⁶



- *Question 8 – Roundabout sign with advisory 30km/hr sign:* The respondents were asked if they had noticed the roundabout sign with the advisory 30km/hr speed sign, which had been installed on all the approaches to the roundabout (see figure 2.9). Most car drivers had not noticed the roundabout sign with advisory 30km/hr sign (65%, including those who were not sure).

Figure 2.62 Question 8 – Did you notice the speed advisory sign?



- *Question 9 – C-roundabout ahead sign:* The respondents were asked if they thought a sign in advance of the roundabout saying that it was a C-roundabout would be helpful – see figure 2.64 for the sign example used. Almost half the car drivers (45.3%) did not think a ‘C-roundabout ahead’ sign would be helpful, but over half the drivers (54.8%) thought that it would be helpful, or they were unclear of what a C-roundabout was, or they were not sure. Thus, it seems that the sign could benefit over half the drivers.

⁶ Non-standard signs and markings, which do not comply with the Land Transport Rule: Traffic Control Devices (TCD Rule), have been used in undertaking this research. Refer to page 3 of this report.

As car drivers were negative towards this tight, slow roundabout it could be appropriate to install a sign on the approach indicating that there is a C-roundabout ahead, so they can prepare themselves for the slow, tight roundabout.

Figure 2.63 Question 9 – C-roundabout ahead sign

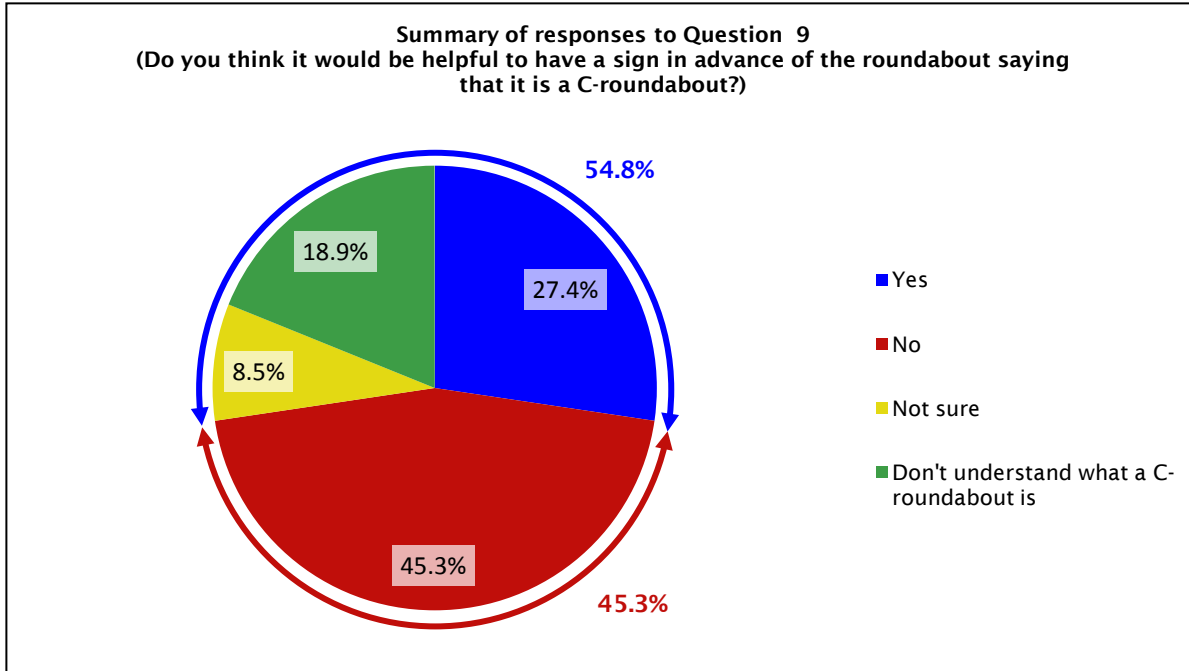
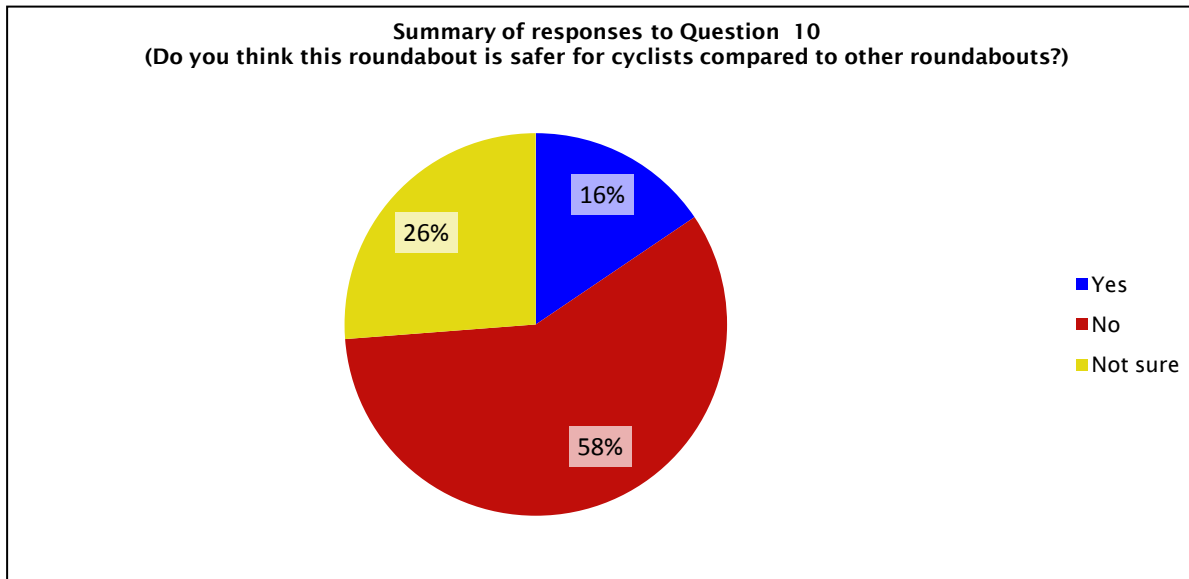


Figure 2.64 C-roundabout ahead sign



- *Question 10 – Cyclists at the C-roundabout:* The car drivers were asked whether they thought the roundabout was safer for cyclists. The majority of car drivers (58%) perceived the C-roundabout to be less safe for cyclists; however, none of the *cyclists* thought it was less safe for cyclists (77% thought it was safer, 15% thought it was about the same) and they would like to see more C-roundabouts installed.

Figure 2.65 Question 10 – Car drivers' impressions of safety for cyclists



- *Questions 11 and 12 – Road marking cycle symbol:* In questions 11 and 12 car drivers were asked if they noticed the road-marking cycle symbol (see figure 2.66) and what their interpretation of the road marking was. Most car drivers (68.6%) had noticed the road marking cycle symbol and most (59%) thought it meant that motorists should look out for cyclists, but only 26% understood it meant that cyclists should use the centre of the lane.

Figure 2.66 Road-marking cycle symbol



Figure 2.67 Question 11 – Road markings (cycle symbol)

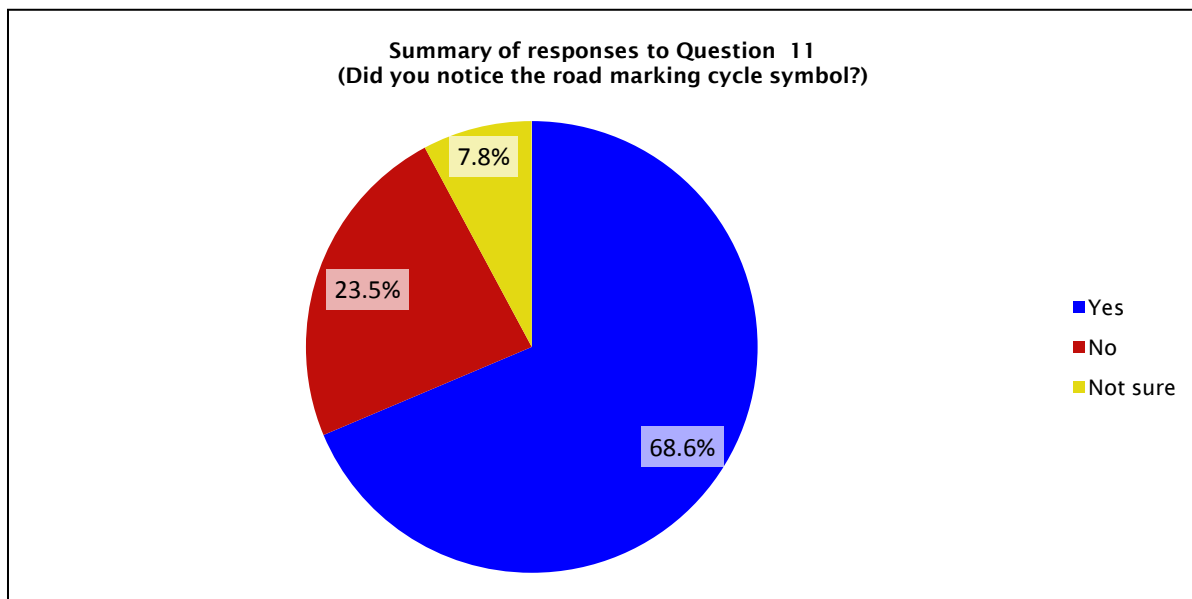
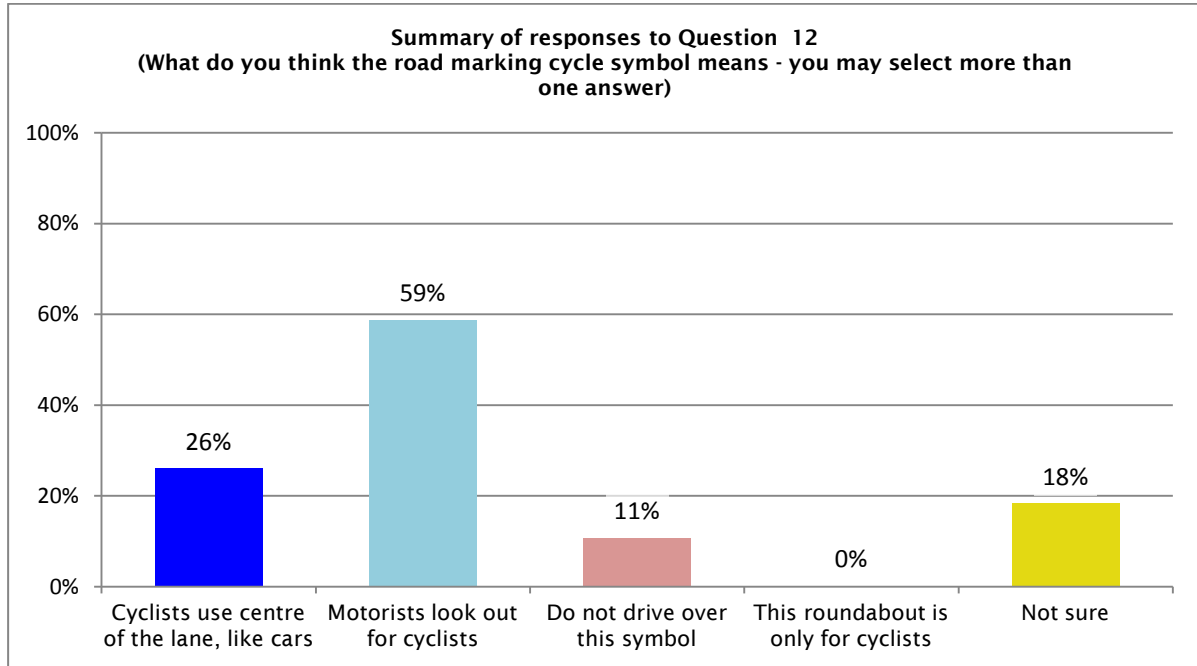
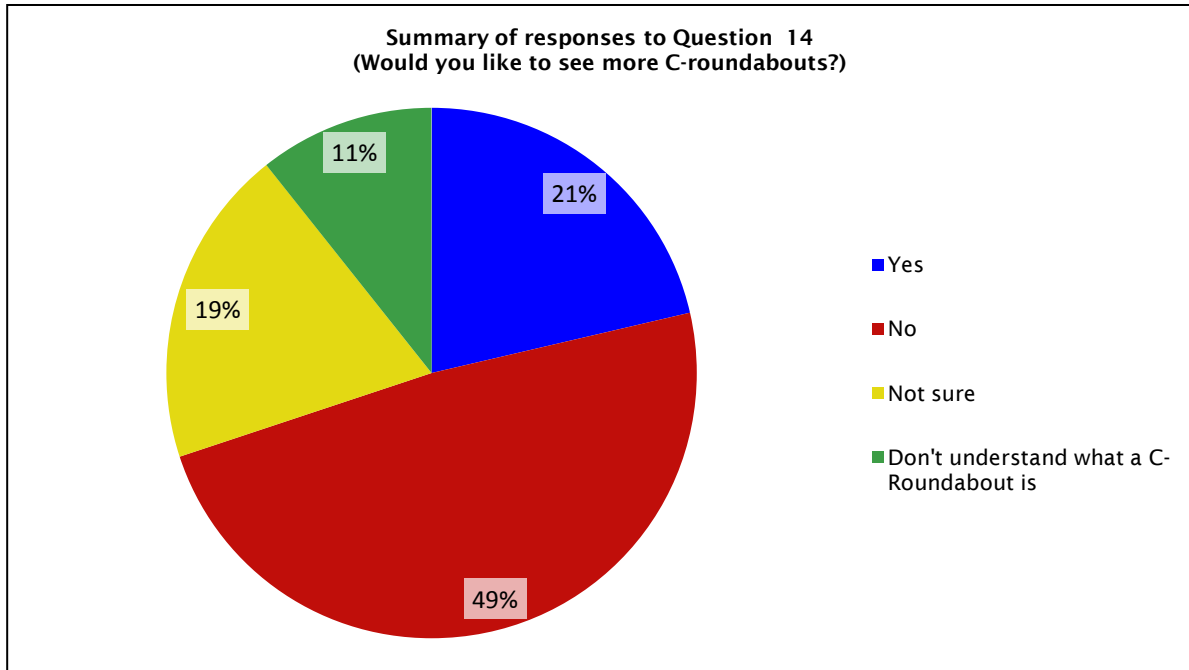


Figure 2.68 Question 12 – Meaning of road-marking cycle symbol



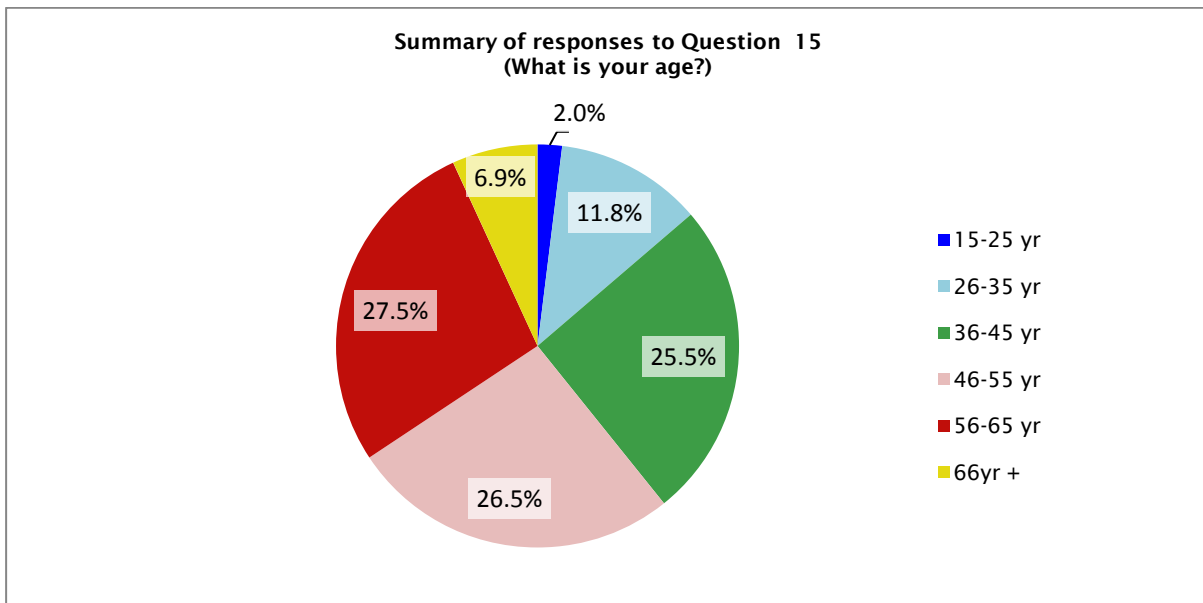
- **Question 13 – Suggestions for improvements to the C-roundabout:** A range of comments and suggestions for the C-roundabout was received from the car driver respondents. The comments were largely negative, with the following main themes:
 - The lanes are too narrow and not liked – 27 respondents commented either negatively about the lanes, or they recommended widening the lanes. Only 2 respondents commented positively on the narrow lanes.
 - The roundabout is unsafe – 14 respondents commented that they thought the roundabout was unsafe or dangerous.
 - The roundabout is unsafe because of the narrow lanes – 12 respondents commented that the narrow lanes made the roundabout unsafe.
 - The roundabout should be changed back to the previous design – 14 respondents commented that they would prefer the roundabout to be changed back to the previous design.
- **Question 14 – Do drivers want to see more C-roundabouts installed?** About half the drivers did not want to see more C-roundabouts installed – 49% responded ‘No’ to having more C-roundabouts, 21% responded ‘Yes’, 19% responded ‘Not sure’ and 11% responded ‘Don’t understand what a C-roundabout is’.

Figure 2.69 Question 14 – Would you like to see more C-roundabouts?



- *Question 15 – Age and gender of respondents:* The age distribution of the respondents is given in the graph below. There were 39 male respondents and 39 female respondents, and 26 respondents who did not specify whether they were male or female.

Figure 2.70 Question 15 – Age of respondents



2.5.4 Local resident survey

2.5.4.1 Introduction

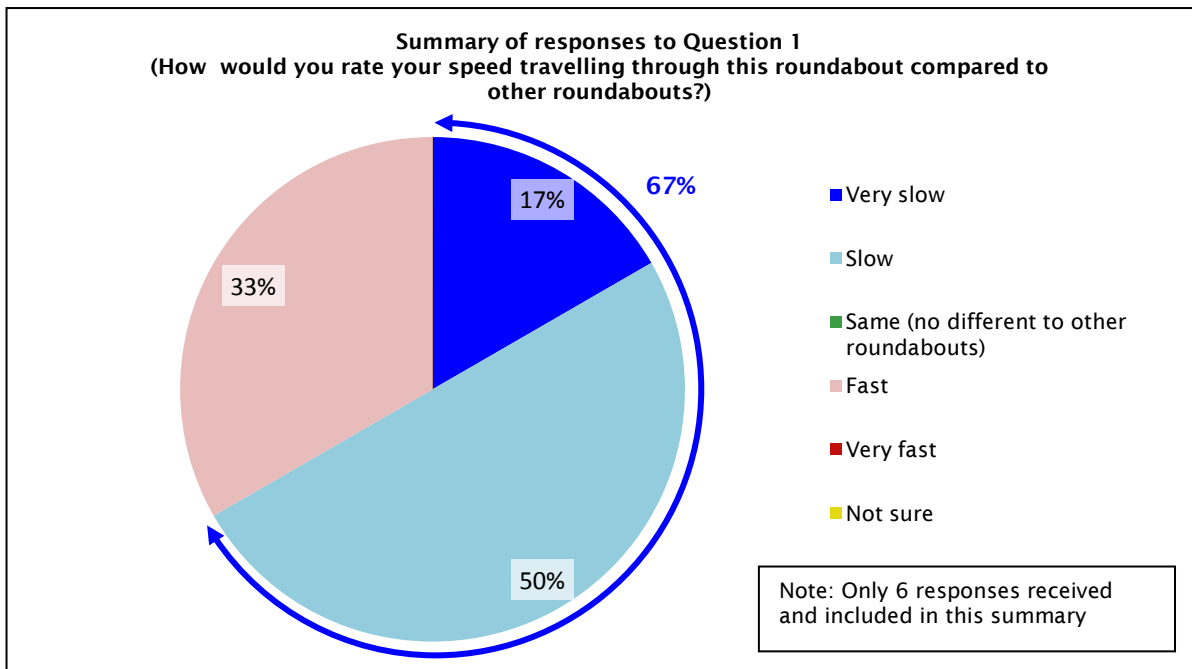
Local residents were surveyed regarding their opinions of the C-roundabout at the Palomino Dr/Sturges Rd intersection, using the questionnaire that was also used for the driver survey (described in section 2.5.3

and included in appendix D). Seventy-seven residents who had properties on the main road within approximately 250 metres of the Palomino Dr/Sturges Rd roundabout were selected as the sample – six of them responded, ie an 8% response rate. With such a small number of responses, the results of the survey should be treated with caution.

2.5.4.2 Survey questions

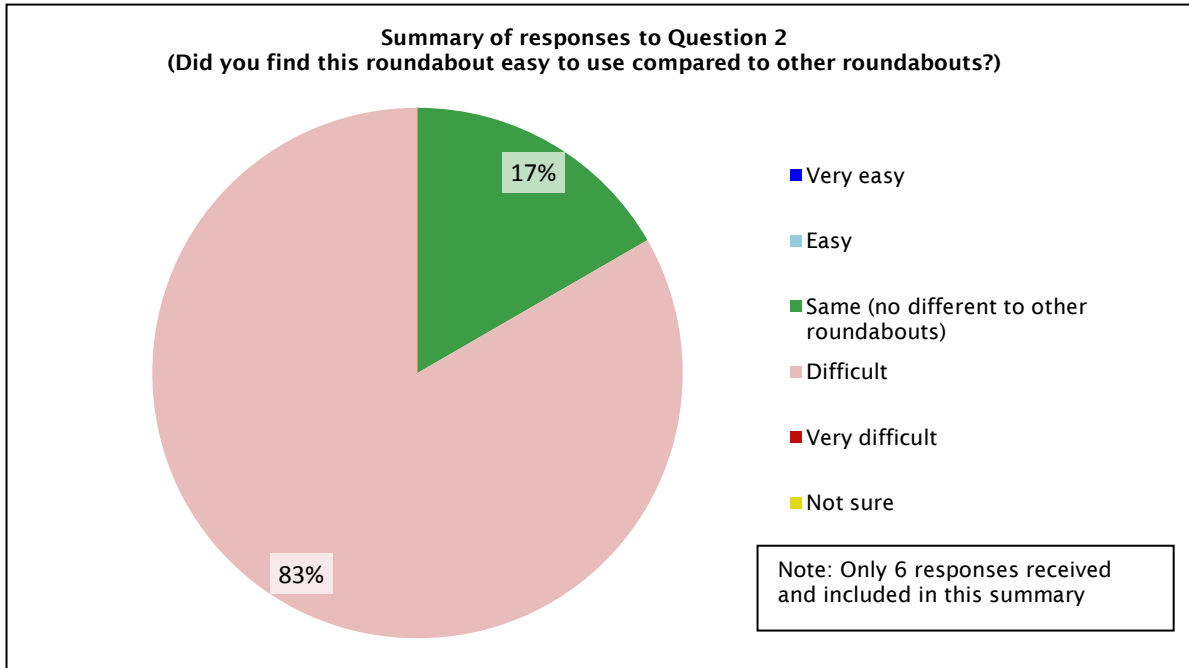
- *Question 1: Residents' impressions of vehicle speed at the C-roundabout:* Most of the residents (67%) thought car speeds were slow, compared with other roundabouts.

Figure 2.71 Question 1 – Residents' vehicle speed through the C-roundabout



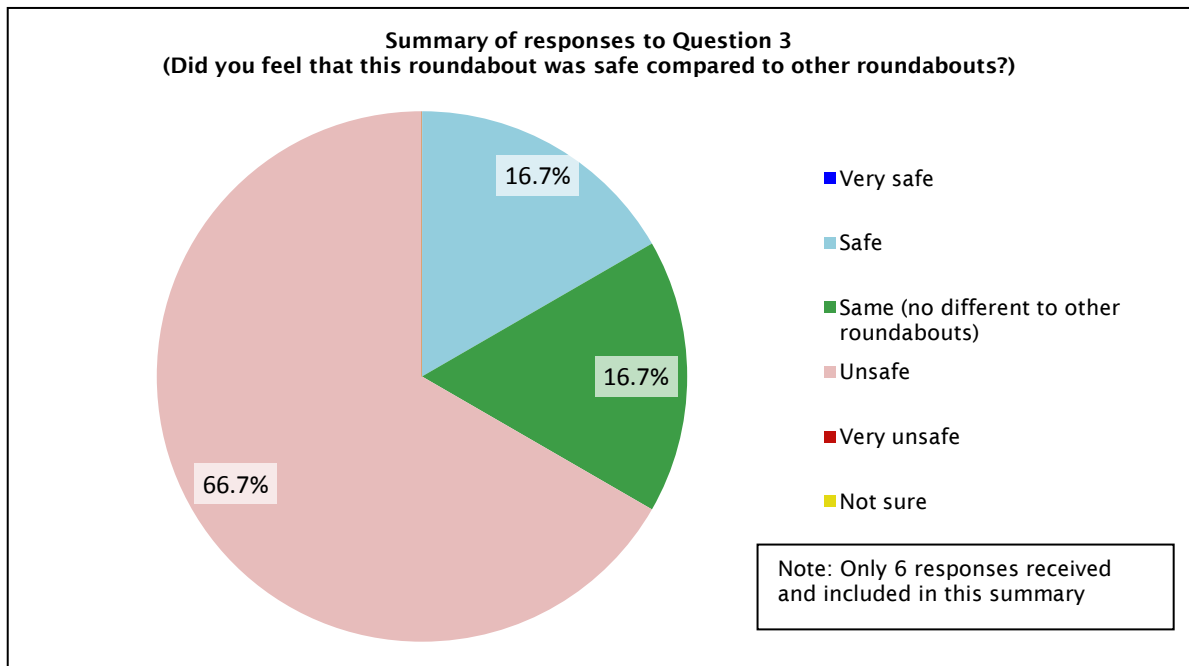
- *Question 2 – Ease of use of C-roundabout for residents:* The majority of the residents (83%) thought this roundabout was 'difficult' to use, compared with other roundabouts.

Figure 2.72 Question 2 – Ease of use for residents



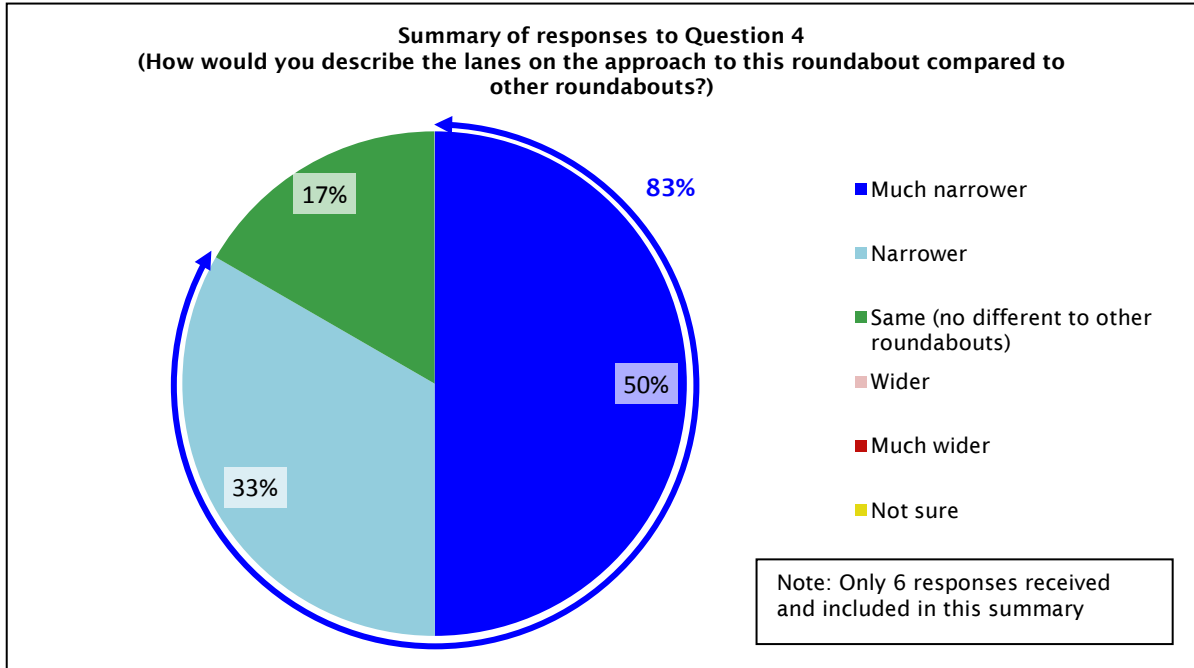
- *Question 3 – Residents’ impressions of the safety of the C-roundabout:* The majority of the residents (4 out of 6 residents, 67%) thought the C-roundabout was unsafe. However, the results of the crash analysis did not confirm this perception as crashes had not increased since the installation of the Palomino Dr/Sturges Rd C-roundabout.

Figure 2.73 Question 3 – Residents’ impressions of the safety of the C-roundabout



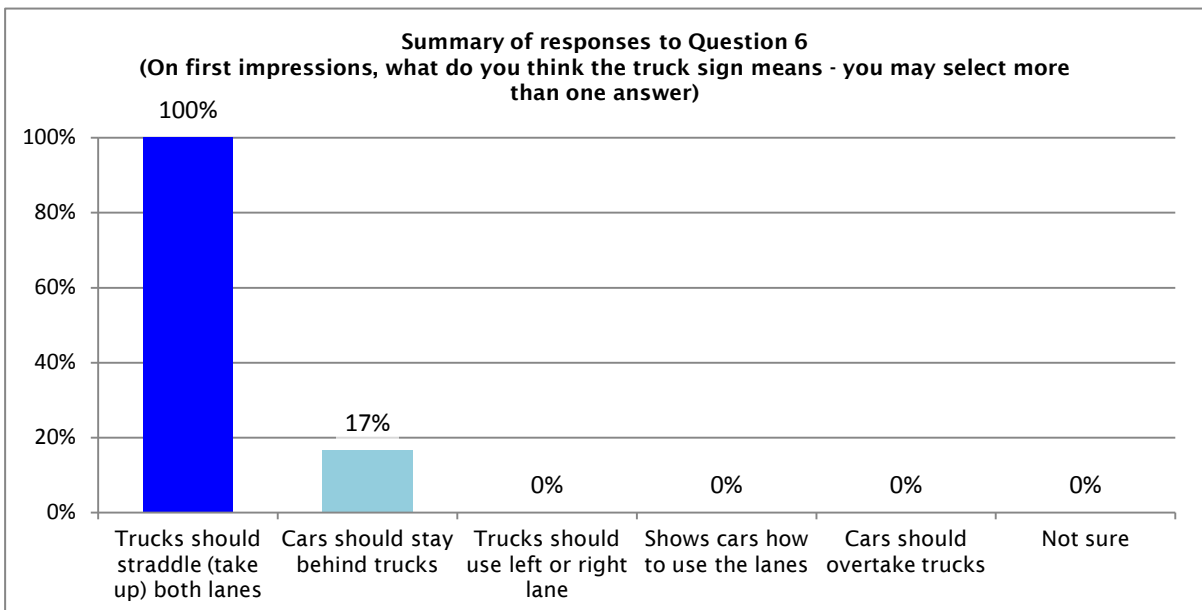
- *Question 4 - Width of lanes:* The majority of the residents (83%) thought the lanes were narrower than at other roundabouts.

Figure 2.74 Question 4 - Width of lanes



- *Questions 5 and 6 - Truck lane-use sign:* Questions 5 and 6 were related to the truck lane-use sign installed on the northern and southern approaches (refer to figure 2.42 for a photo). The respondents were first asked if they noticed the sign and then what they thought the sign meant. All of the residents (100%) had noticed the sign and all of them understood it meant that trucks should straddle both lanes. However, only 17% understood that it also meant that cars should stay behind trucks and not try to squeeze in beside them.

Figure 2.75 Question 6 - Residents' interpretations of sign



- *Question 7 – Alternative truck lane-use sign design:* An alternative sign design was presented (see figure 2.77) and the respondents were asked to state their preference, given the intended meaning of the sign (ie, that large trucks and buses should straddle both lanes and cars should stay behind them). Most of the residents (66.7%) thought the existing truck lane-use sign (sign no.2) was better.

Figure 2.76 Question 7 – Residents’ opinions of alternative truck lane-use sign

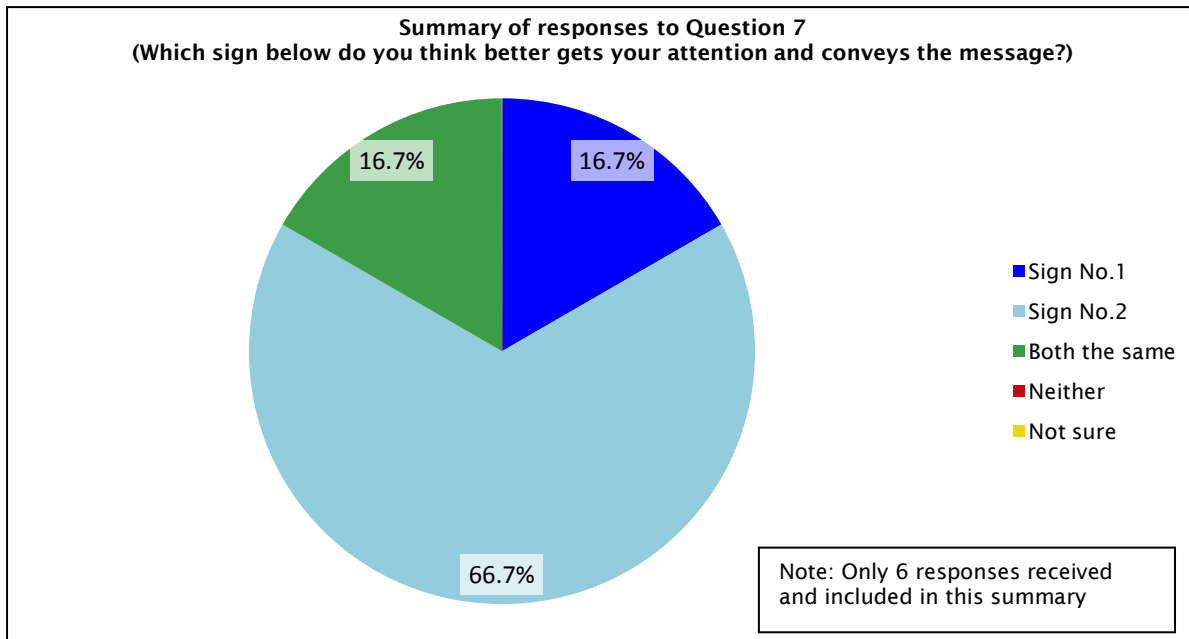
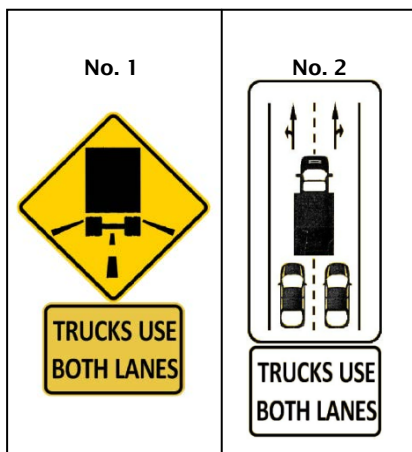


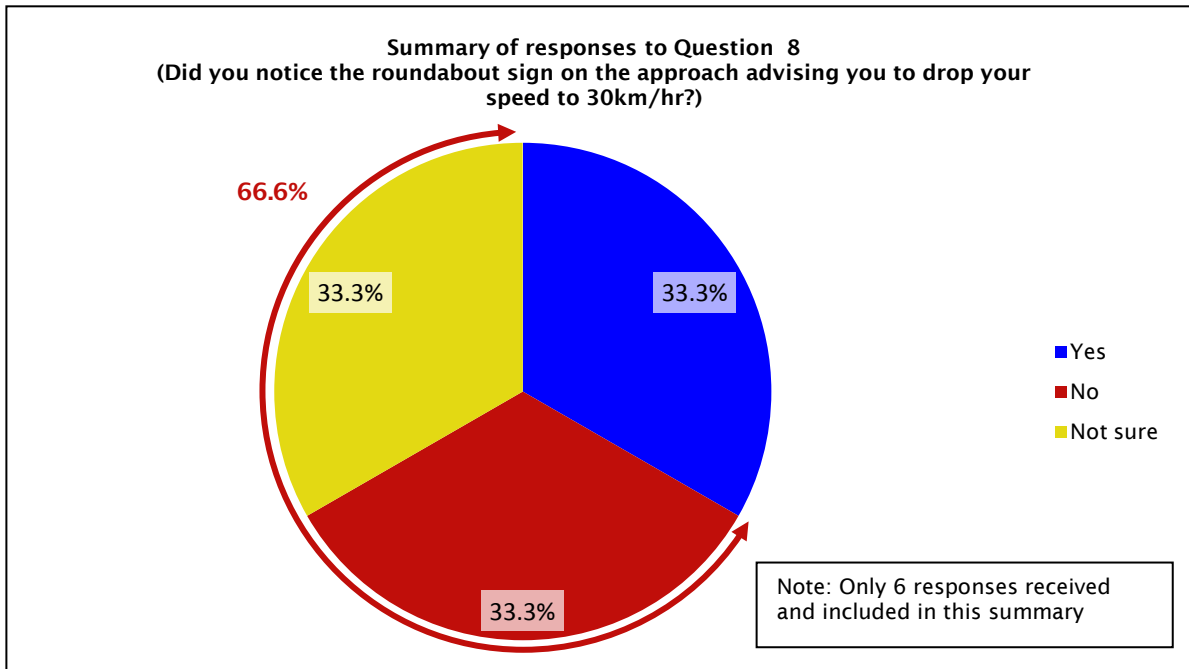
Figure 2.77 Truck lane-use sign options



- *Question 8 – Roundabout sign with advisory 30km/hr sign:* The respondents were asked if they had noticed the roundabout sign with the advisory 30km/hr speed sign (see figure 2.9), which had been installed on all the approaches to the roundabout.

Over half of the residents said the roundabout sign with advisory 30km/hr sign was not noticeable (66.6% did not see it, or were not sure).

Figure 2.78 Question 8 - Did you notice the speed advisory sign?

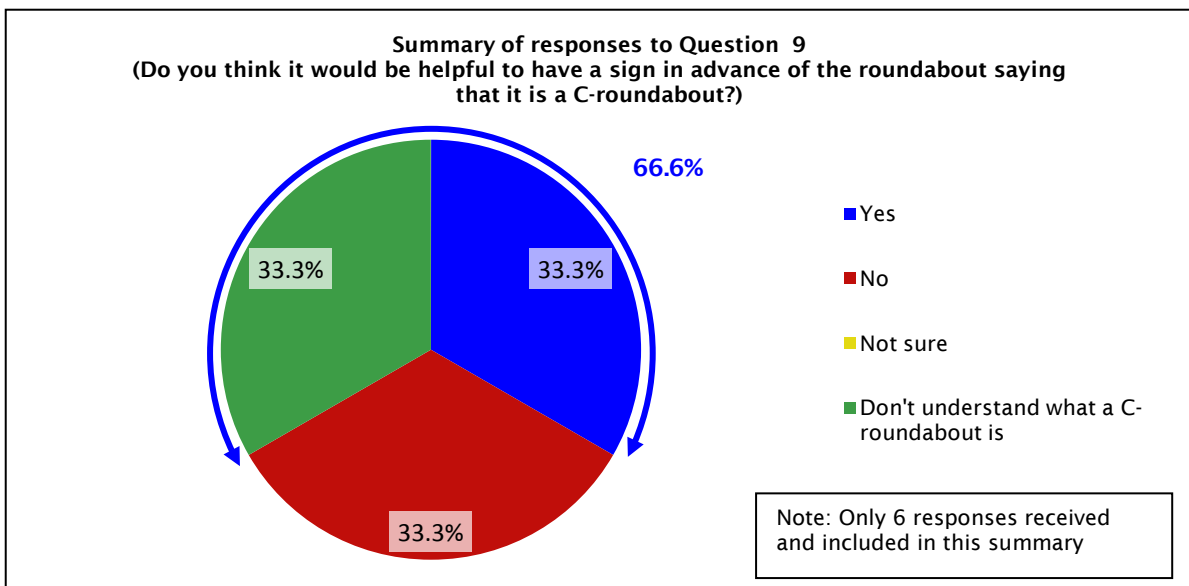


- *Question 9 - C-roundabout ahead sign:* The respondents were asked if they thought a sign in advance of the roundabout saying that it was a C-roundabout (see figure 2.79) would be helpful. Over half the residents (66.6%) thought either it would be helpful to have C-roundabout ahead sign, or they were unclear of what a C-roundabout was. Thus, it seems that the sign would be helpful.

Figure 2.79 C-roundabout ahead sign

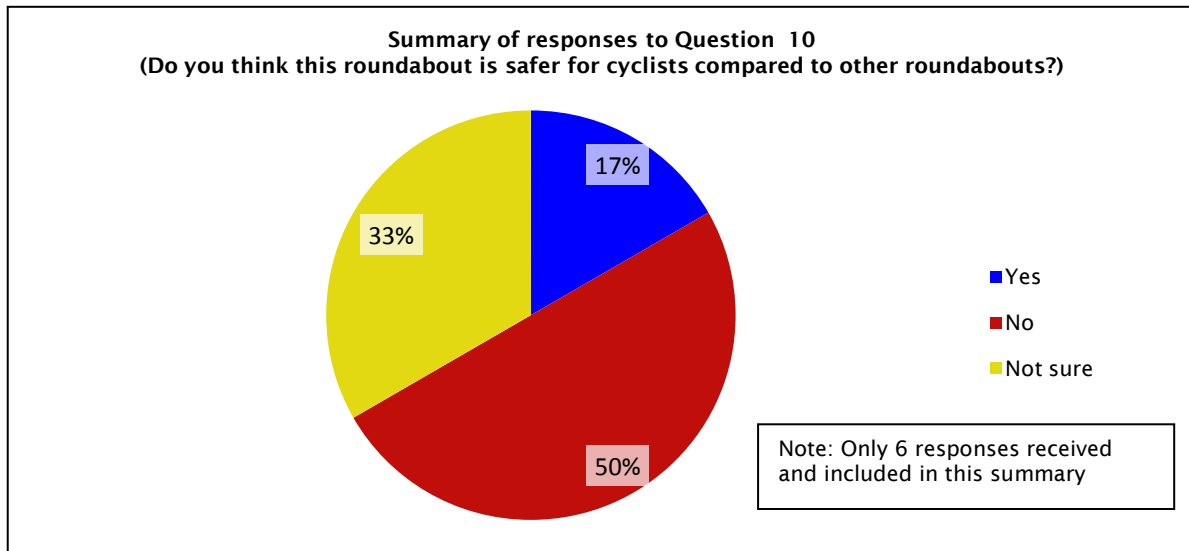


Figure 2.80 Question 9 - C-roundabout ahead sign



- Question 10 – Cyclists at the C-roundabout:** The residents were asked whether they thought the C-roundabout was safer for cyclists. Half of the residents (3 out of 6 residents, 50%) perceived the C-roundabout to be less safe for cyclists; however, none of the cyclists surveyed thought it was less safe for cyclists (77% thought it was safer, 15% thought it was about the same as other roundabouts) and they would like to see more C-roundabouts installed.

Figure 2.81 Question 10 – Residents’ impressions of safety for cyclists



- Questions 11 and 12 – Road-marking cycle symbol:** The residents were asked if they had noticed the road-marking cycle symbol (see figure 2.83) and if so, what their interpretation of the road marking was. All of the residents (100%) had noticed the road-marking cycle symbol, and half of them understood that cyclists should use the centre of the lane, like cars.

Figure 2.82 Question 12 – Meaning of road-marking cycle symbol

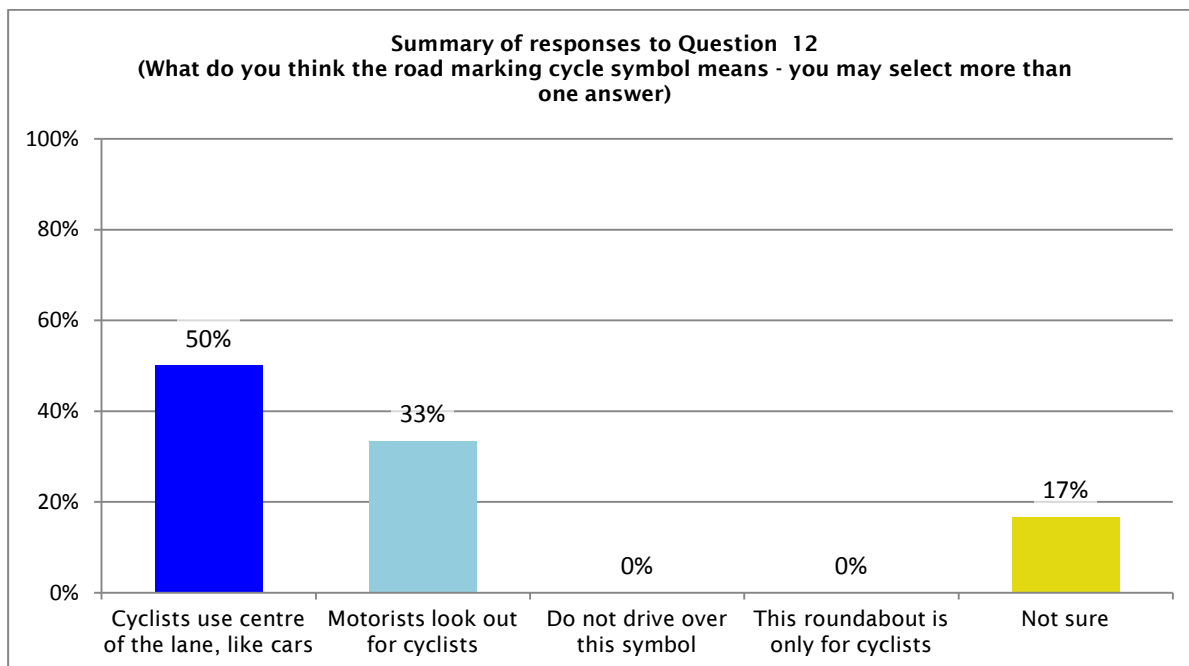
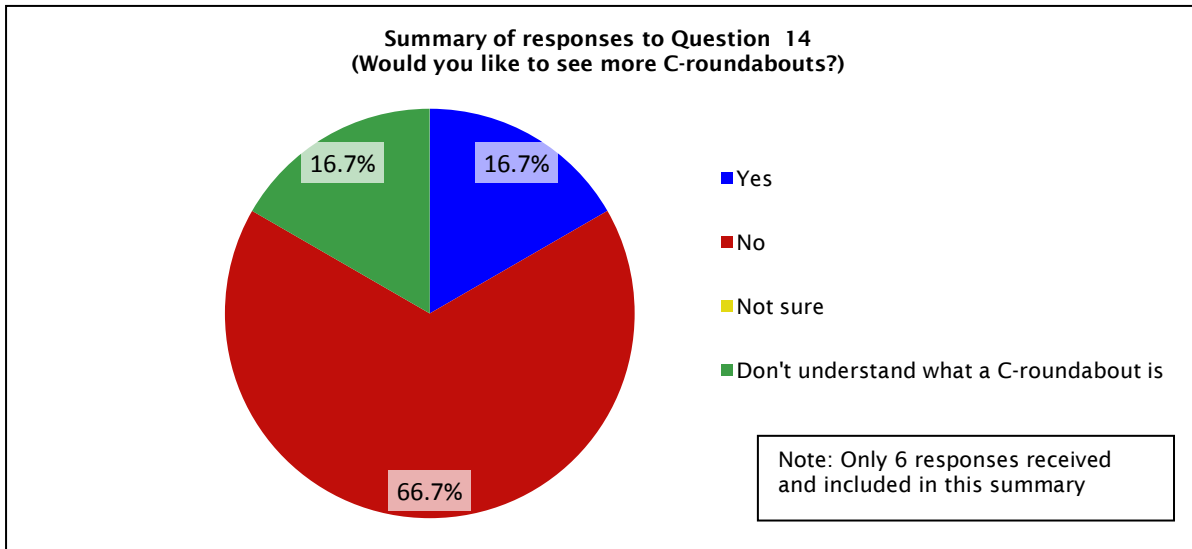


Figure 2.83 Road-marking cycle symbol



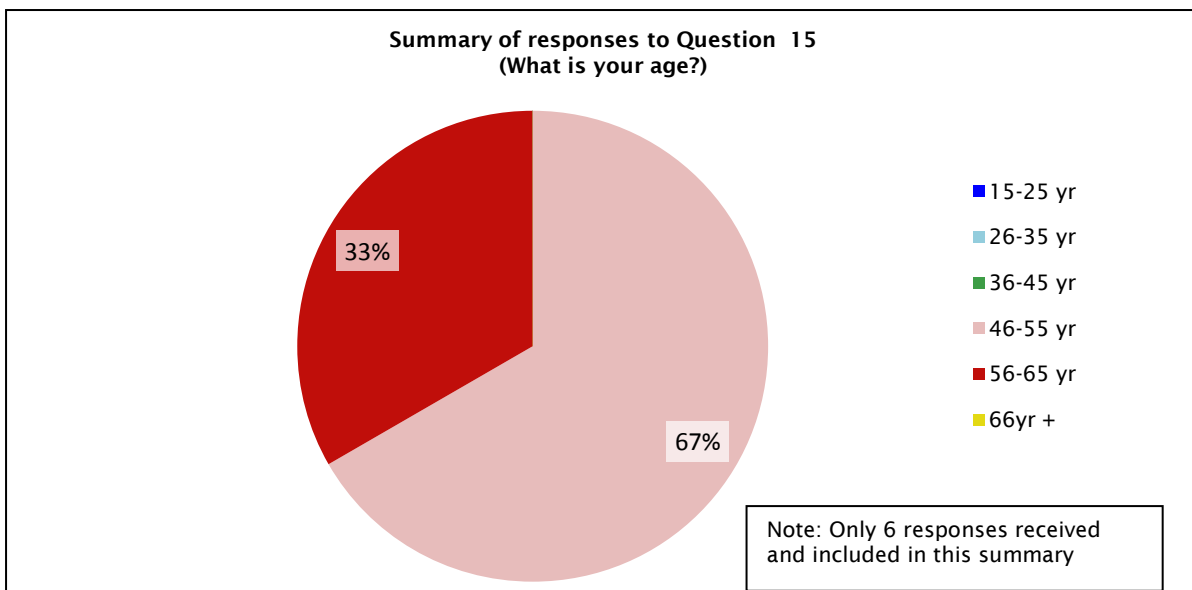
- Question 14 - Do residents want to see more C-roundabouts installed? The majority of residents (4 out of 6 residents, 66.7%) did not want to see more C-roundabouts installed.

Figure 2.84 Question 14 - Would you like to see more C-roundabouts?



- Question 15 - Age and gender of respondents: The age distribution of the respondents is given in the graph below. There were two male respondents and one female respondent, and three respondents who did not specify whether they were male or female.

Figure 2.85 Question 15 - Age of respondents



2.5.5 Summary of the results of the surveys

The C-roundabout design received positive feedback from cyclists and pedestrians. However, a less positive reaction was received from the car drivers and local residents; about half the car drivers were not in favour of the C-roundabout. This could be expected as car drivers may prefer a wider roundabout than the narrow C-roundabout, as it is easier to manoeuvre through.

2.5.5.1 Summary of cyclists' survey (14 responses received)

- Cyclists were positive about the C-roundabout installed at the Palomino Dr/Sturges Rd intersection and 93% (13 out of 14 responses) said they would like to see more C-roundabouts installed.
- In general, the cyclists found the C-roundabout easier to use, safer, and better for cyclists. They felt that the car speeds were lower.
- Cyclists found the signs and road markings helpful, although the cycle symbol road marking was not particularly well understood.

2.5.5.2 Summary of pedestrians' survey (23 responses received)

- Pedestrians were positive about the C-roundabout and in general found it safe and better for pedestrians. They found it easy to cross, and noticed that the crossing distance was narrower and that the car speeds were slower.
- Of the pedestrian respondents 35% (8 out of 23) would like to see more C-roundabout installed and only 13% (3 out of 23) did not want to see more C-roundabouts installed.

2.5.5.3 Summary of car drivers' survey (104 responses)

- The majority of car drivers noticed that car speeds were slower at the C-roundabout and the lanes were narrower, which is the intention of the C-roundabout design.
- About half the car drivers did not favour the C-roundabout installed at Palomino Dr/Sturges Rd and did not want to see more C-roundabouts installed (49%). About half the drivers found the C-roundabout more difficult to use and indicated a preference for a standard roundabout. This could be expected, as a narrower roundabout is more difficult for a driver to manoeuvre through.
- Over half the car drivers thought the C-roundabout was 'safe' or 'the same as other roundabouts', but a significant proportion thought it was unsafe (41%). The results of the crash analysis did not confirm the perception of the C-roundabout being unsafe. Also, as the vehicle speeds have dropped it is unlikely that the C-roundabout will be less safe.
- The majority of the car drivers thought the roundabout was actually less safe for cyclists, and thus were unable to recognise the benefits of the C-roundabout for cyclists.
- The drivers who provided comments were largely negative towards the new C-roundabout and in particular felt that the lanes were too narrow and the roundabout was now less safe.
- The car drivers' impressions of the roundabout may improve if they are informed of the benefits of the C-roundabout for cyclists, and of the cyclists' support for the C-roundabout. Also, their impressions may improve over time as they become accustomed to using the tight, slower roundabout. Further monitoring of the drivers' impression of the C-roundabout should be undertaken.

2.5.5.4 Summary of local residents' survey (6 responses)

The local residents' survey had a low response rate, with only 6 responses received (an 8% response rate) – therefore the following results should be treated with caution:

- The majority of residents did not favour the C-roundabout installed at Palomino Dr/Sturges Rd and 67% (4 out of 6) did not want to see more C-roundabouts installed.
- In general, the local residents' impression of the C-roundabout design was that it was more difficult to use, less safe for motorists (not confirmed by crash analysis) and less safe for cyclists.
- They felt that the car speeds were slower and they noticed that the lanes were narrower.

2.5.5.5 Summary of responses to questions about signs and road markings at the C-roundabout

- *Cycle symbol road marking*: This was not particularly well understood by cyclists (only 43% thought they adequately communicated to cycle in the centre of the lanes). However, the majority of car drivers noticed the road marking (68.6%) and thought it meant to look out of cyclists (59%), which was a good result as it should result in car drivers being more aware of cyclists. The cycle symbol road marking has been included in the preliminary guidelines (refer to appendix E).
- *Truck lane-use sign*: This sign was noticed by car drivers and was well understood; 83% noticed the sign and 88% understood its meaning. It has been included in the preliminary guidelines (refer to appendix E).
- *Roundabout sign with advisory 30km/hr*: The majority of car drivers (65%) did not notice the sign and as a result, a larger sign has been included in the preliminary guidelines (refer to appendix E).
- *'C-roundabout ahead' sign*: Over half the car drivers thought that either the sign would be helpful, or they were unclear of what a C-roundabout was, or they were not sure. Thus, it seems that the sign may be beneficial.

2.5.6 Recommendations based on the survey results

- Car drivers should be educated about the benefits of the C-roundabout; ie, the improved safety for cyclists. They should also be informed of the cyclists' overwhelming support for the C-roundabout and that the cyclists would like to see more installed.
- Further research should be undertaken in six months time to determine whether car drivers still have a negative impression of the C-roundabout. It is considered likely that over time the car drivers will get used to driving through the tighter, slower roundabout, and so their support for the C-roundabout may improve.
- If the car drivers' impression of the C-roundabout does not improve, then further research could be done to investigate whether it would be possible to increase the lane widths to make the C-roundabout more comfortable for drivers, but without compromising the design principles of the C-roundabout of reducing vehicle speeds for cyclist safety. It may be possible to increase the clearance between the cars (99 percentile) from 0.5m to 1m to improve car drivers' comfort when travelling through the roundabout.

3 Margan Ave/Hutchinson Ave roundabout (single lane changed to two narrow lanes)

3.1 Introduction

The Margan Ave/Hutchinson Ave roundabout was also reviewed as part of this research project. The reconstruction of this roundabout involved changing the northern and eastern approaches from wide, single lanes to two narrow lanes. The primary reason for modifying this roundabout was to increase the capacity of the northern and eastern approaches, which were experiencing long queues, at a low cost (no changes to the kerbs were required). No changes to the vehicle deflection (100-metre radius and greater) were undertaken, so the vehicle speeds (design speed of 50km/hr and greater) were not expected to be significantly affected.

It should be noted that the reconstruction of the Margan Ave/Hutchinson Ave did not comply with the principles of the C-roundabout design as it did not involve increasing the vehicle deflection to slow down vehicle speeds through the roundabout to around 30km/hr. Thus, the differential speed between vehicles and cyclists was not expected to decrease – ie cyclist safety was not specifically being addressed at this site and the roundabout was not being made cyclist-friendly.

The intention of studying this site was to assess whether or not it would be possible to fit a small double-lane roundabout within the same road reserve as a single-lane roundabout, thus improving the capacity at low cost without any decrease in safety. The operation of this site was assessed in terms of the roundabout's safety and capacity performance.

3.2 New design of Margan Ave/Hutchinson Ave roundabout

The Margan Ave/Hutchinson Ave roundabout was reconstructed in November 2007, before the start of this research project. The northern and eastern approaches were changed from wide single lanes to two narrow lanes with kerb-to-kerb widths of about 5.4 metres. Refer to figure 3.1 for aerial photos of the roundabout before and after the reconstruction and figure 3.2 for an illustration of the modifications made to the roundabout.

The new two narrow lane approaches were designed for two 99 percentile cars to travel alongside each other through the roundabout. As the lanes were narrow (5.4 metres from kerb to kerb), it was expected that buses and trucks would need to straddle both lanes on the approach and through the roundabout. It was important that trucks/buses did not attempt to travel through the roundabout with a car next to them, as this could result in a sideswipe crash.⁷

⁷ Non-standard signs and markings, which do not comply with the Land Transport Rule: Traffic Control Devices (TCD Rule), have been used in undertaking this research. Refer to page 3 of this report.

Figure 3.1 Aerial photos for the Margan Ave/Hutchinson Ave roundabout prior to and following reconstruction

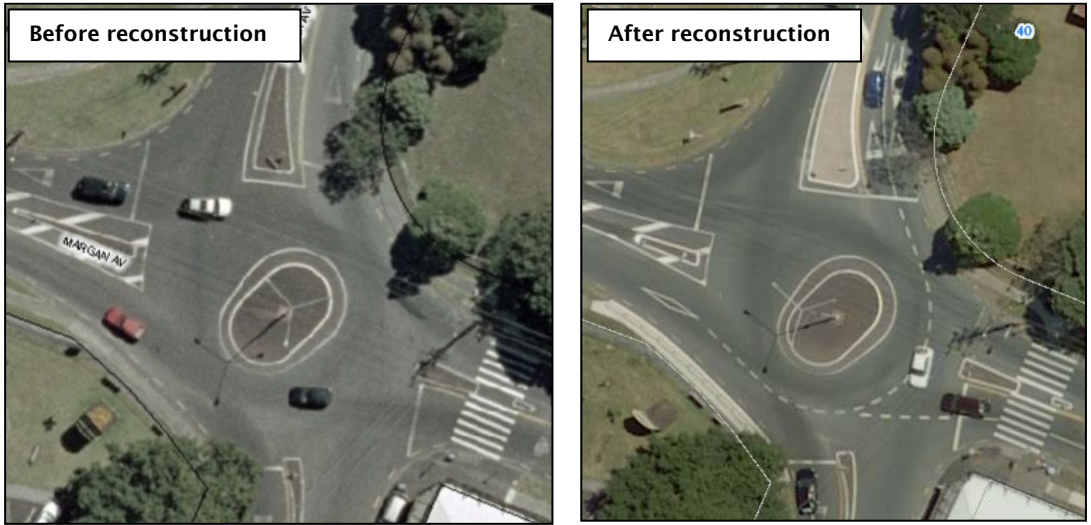
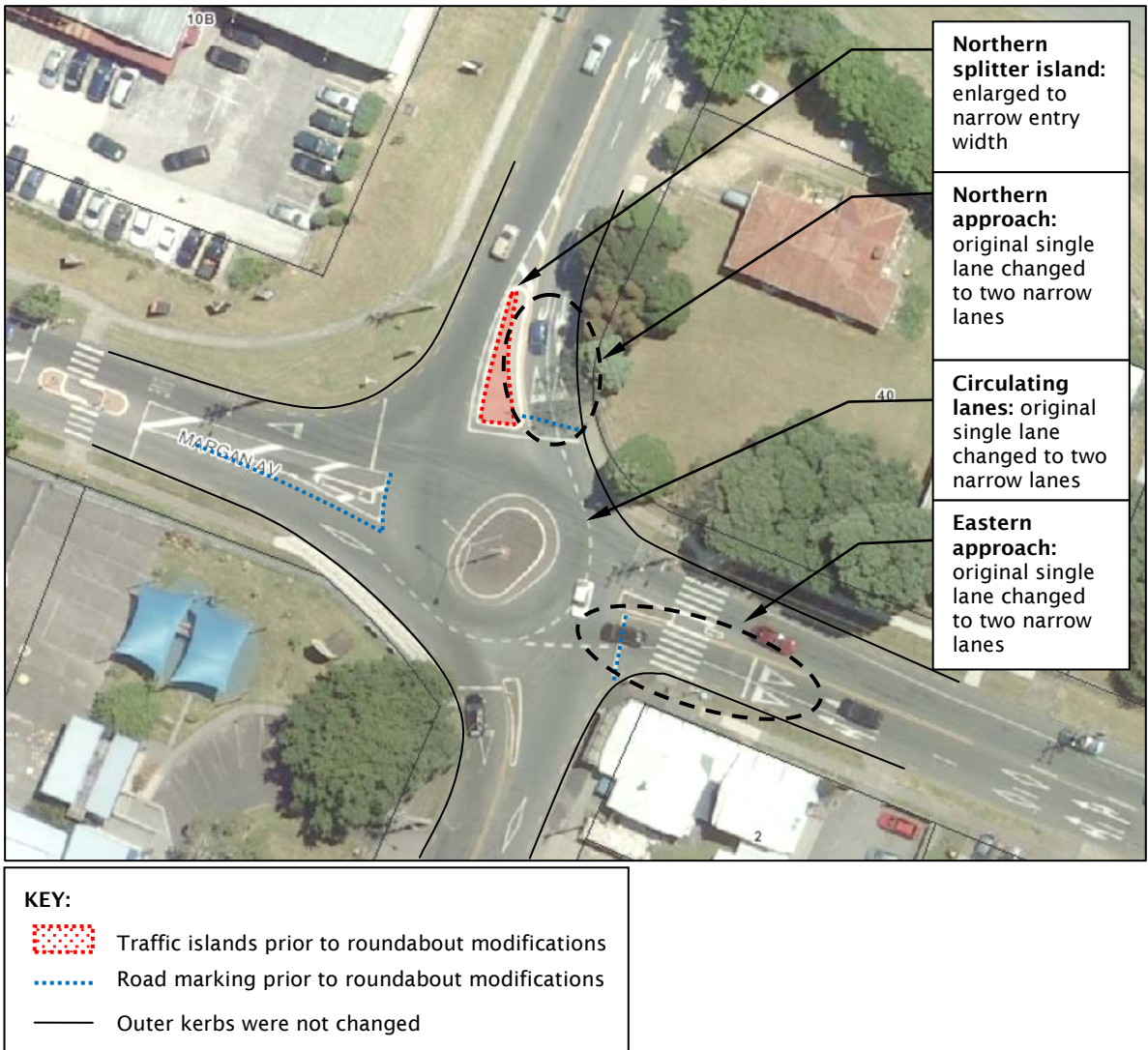


Figure 3.2 Illustration of modifications made to the Margan Ave/Hutchinson Ave roundabout



3.3 Safety of the Margan Ave/Hutchinson Ave roundabout

The objective of reviewing the safety performance of the Margan Ave/Hutchinson Ave roundabout was to assess the safety implications of converting single-lane roundabouts to narrow two-lane roundabouts, when no changes to the design speed are undertaken.

3.3.1 Crash analysis

3.3.1.1 Methodology

The reported crashes for before and after the roundabout was modified were reviewed. The reported crash data was obtained using the NZTA's CAS. Collision diagrams for before and after the roundabout reconstruction are shown in figures 3.3 and 3.4. Some corrections to the CAS collision diagrams were made based on a review of the Traffic Crash Reports – eg corrections to the crash movement type and the crash location on the roundabout.

3.3.1.2 Crashes before reconstruction

The 10 years prior to the roundabout being altered were reviewed (November 1997 to November 2007). During this 10-year period there was a total of 22 crashes – ie 2.2 crashes per year (see figure 3.3).

The following crash patterns existed over the 10-year period:

- 'Entry versus circulating' crash on western approach (HA crash movements): 7 HA crashes occurred, ie 0.7 per year.
- 'Entry versus circulating' crash on eastern approach (HA crash movements): 4 HA crashes occurred, ie 0.4 per year.
- 'Entry versus circulating' crash on southern approach (HA crash movements): 3 HA crashes occurred, ie 0.3 per year.

3.3.1.3 Crashes after reconstruction

After the roundabout was altered there were 23 crashes over 4 years (November 2007 to November 2011), ie 5.75 crashes/year (see figure 3.4).

The following crash patterns existed over the 4-year period:

- 'Entry versus circulating' crash on western approach (HA and LB crash movements): 6 HA crashes and 1 LB crash occurred, ie 1.75 'entry versus circulating' crashes per year.
- 'Entry versus circulating' crash on eastern approach (HA and LB crash movements): 5 HA crashes and 3 LB crash occurred, ie 2 'entry versus circulating' crashes per year.

3.3.1.4 Injury crashes

In the 10-year period prior to the reconstruction there were 6 injury crashes at the roundabout, ie 0.6 injury crashes/year. In the 4 years since the reconstruction there had been 5 injury crashes, ie 1.25 injury crashes/year.

Figure 3.3 CAS collision diagram for Margan Ave/Hutchinson Ave intersection BEFORE the roundabout reconstruction (10 years, November 1997–November 2007)

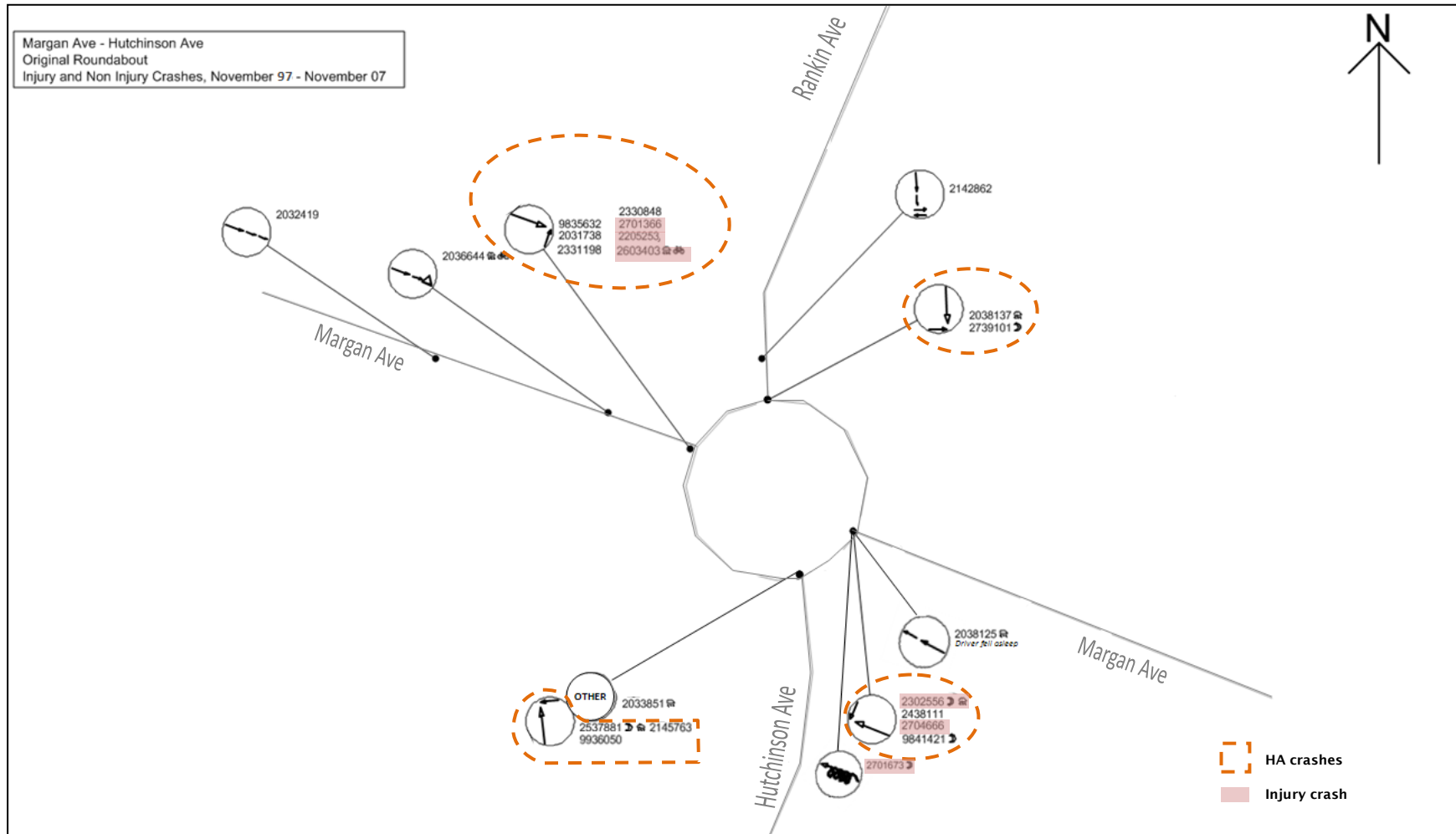
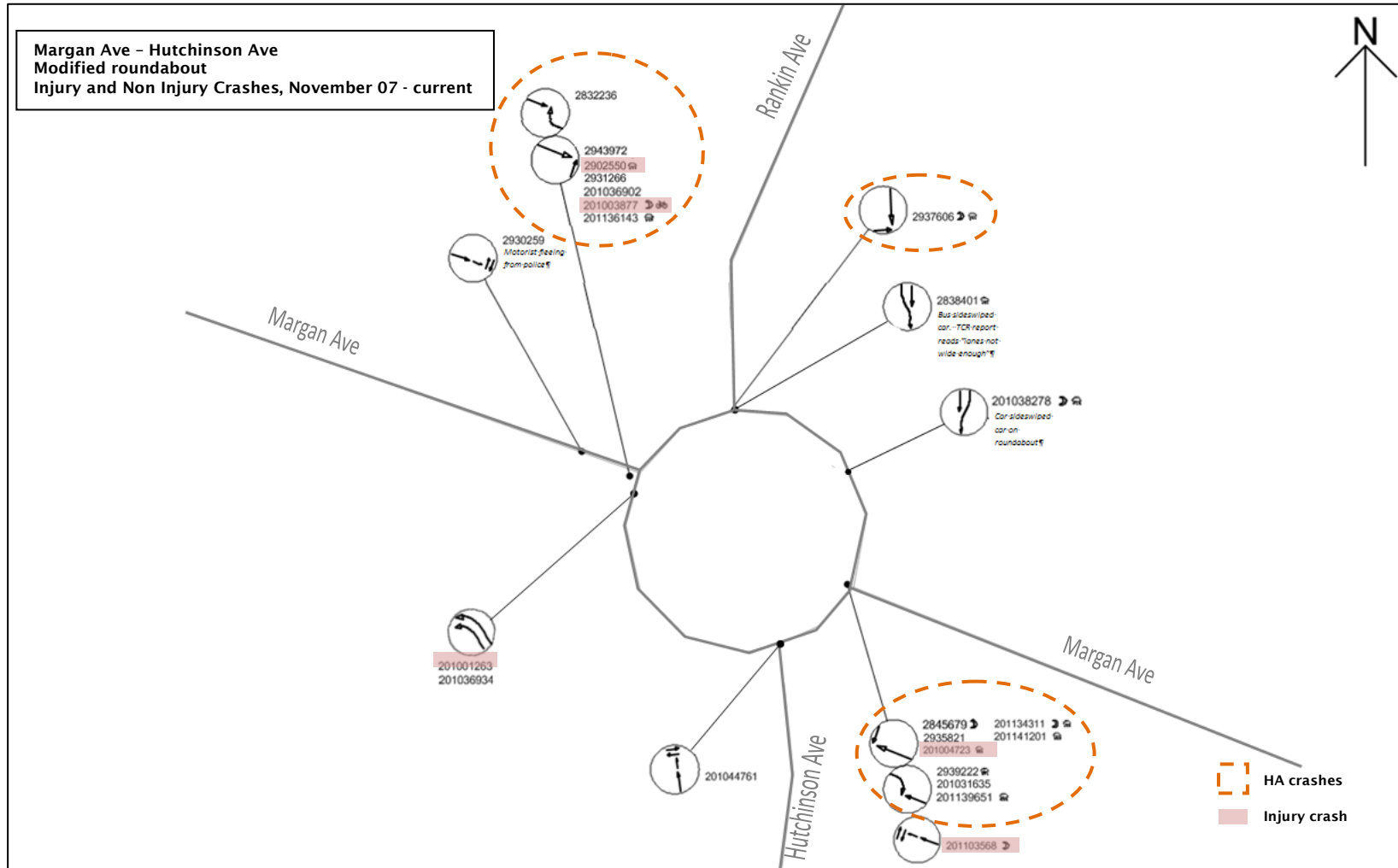


Figure 3.4 CAS collision diagram for Margan Ave/Hutchinson Ave intersection AFTER the roundabout reconstruction (4 years, November 2007–November 2011)



3.3.1.5 Sideswipe crashes on new narrow double lanes

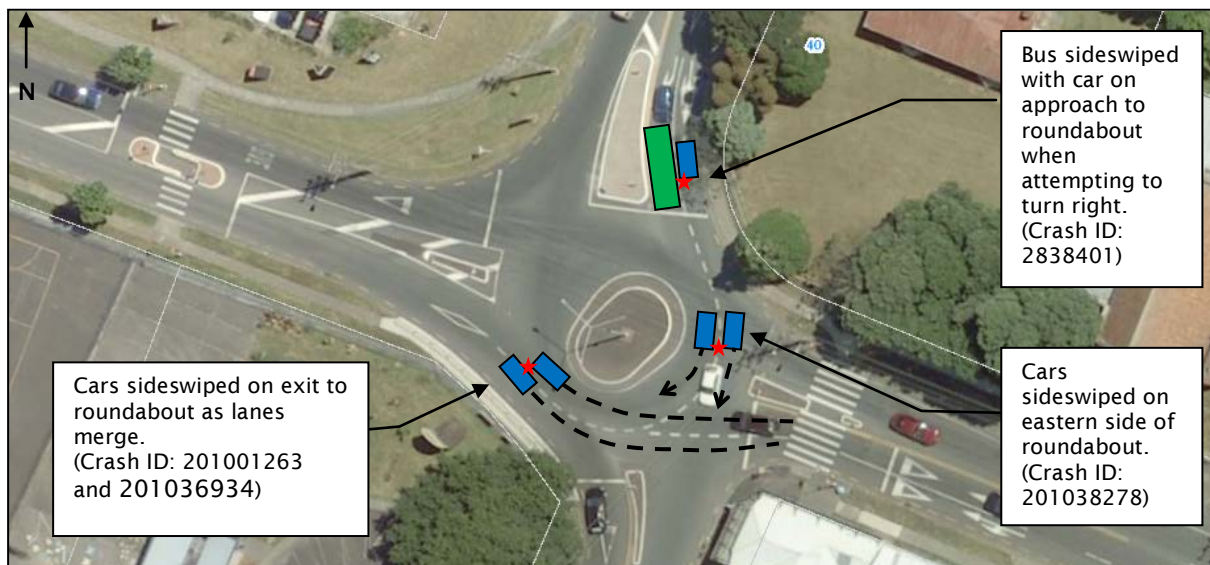
There had been four sideswipe crashes in the four years since the installation of the two narrow lanes on the eastern and northern approaches (see figure 3.5).

- Bus sideswipe with car on northern approach (Crash ID 2838401): A bus failed to straddle both approach lanes and instead approached the roundabout in the inner lane. The bus then cut across into the kerbside lane and collided with a car waiting in this lane. This crash occurred before a truck lane-use signage was installed

This crash indicates that it is important to install truck lane-use signage on the narrow two-lane approaches, to tell bus/truck drivers to straddle both approach lanes and car drivers to stay behind buses/trucks. This will discourage car drivers from squeezing next to buses/trucks and thus prevent similar sideswipe crashes from occurring. A new truck lane-use sign has since been installed and it is likely that this will address this type of crash.

- Cars sideswipe on eastern side of roundabout (Crash ID: 201038278): This involved two cars travelling adjacent to each other and sideswiping on the eastern side of the roundabout. The car in the kerbside lane crossed over the lane line and collided with the car in the inner lane. It appears from the Traffic Crash Report that the car in the kerbside lane was intending to travel straight through to Hutchinson Ave, and the car in the inner lane was intending to turn right to Margan Ave.
- Cars sideswipe at exit to roundabout, travelling westbound (Crash ID: 201001263 and 201036934): Both these crashes involved two cars travelling adjacent to each other through the roundabout from the east to the west approach and sideswiping on the exit, as the lanes merge. One of these crashes was a minor-injury crash. It is unclear whether the crashes were associated with the two circulating lanes or with the merging of the lanes. It is considered likely that if a longer merge distance had been provided at this roundabout exit, these crashes may not have occurred.

Figure 3.5 Sideswipe crashes on new narrow double lanes at the Margan Ave/Hutchinson Ave roundabout



3.3.1.6 Comparison between before and after reconstruction

The crash rate at the site increased from 2.2 crashes per year (10-year period) to 5.75 crashes per year (4-year period). Also, the injury crash rate increased from 0.6 to 1.25 injury crashes/year.

The increase in the crash rate is very unlikely to be the result of chance, as the change in the crash rate after the alterations to the roundabout was more than the ‘critical change in the mean’ of 1.2 for this site (based on Austroads *Guide to road safety* (2009a)).

Thus, the safety of the roundabout appears to have decreased since the changes were made. It is expected that if a roundabout is changed from one lane to two lanes then the crash rate will increase. It is recommended that measures be undertaken to mitigate the increase in crashes.

3.3.2 Increase vehicle deflection to address safety concerns

The original design speed of the roundabout was not changed in the reconstruction. The southern approach has a low design speed of around 36km/hr (50m radius). However, the other approaches have high design speeds of around 50km/hr (110m and 90m radius). It is recommended that the deflection of the roundabout be increased so that the design speeds are reduced to around 30km/hr. An illustration of the recommended changes is shown in figure 3.6.

Figure 3.6 Recommended changes to Margan Ave/Hutchinson Ave roundabout to increase vehicle deflection



The increased vehicle deflection should address the safety issues and make the narrow two-lane roundabout safer.

In one year's time, the crash history should be reviewed again to determine whether the safety has improved (one year's worth of crash data should provide a statistically significant result if the critical change in the mean is calculated as per Austroads *Guide to road safety* (2009a)).

If the recommended increase in vehicle deflection is successful in reducing the crash rate, then it will prove the principle of the C-roundabout – that speeds should be reduced for safety – to be correct.

3.3.3 Conclusions regarding the safety of the Margan Ave/Hutchinson Ave roundabout

- Changing the single-lane roundabout to two narrow lanes on two approaches, without reducing the vehicle design speed, resulted in a significant increase in the crash rate (increased from 2.2 to 5.75 crashes per year).
- The injury crash rate also increased from 0.6 to 1.25 injury crashes per year.
- Vehicle speeds should be reduced to around 30km/hr by increasing the vehicle deflection, to mitigate the increased crash rate.
- It may not be advisable to install narrow double-lane roundabouts without decreased vehicle speeds at other sites until the safety concerns have been addressed or confirmed.
- In the four years since the reconstruction there had also been four sideswipe crashes on the new 'two narrow lane' approaches (northern and eastern approaches).

3.3.4 Recommendations regarding the safety of the Margan Ave/Hutchinson Ave roundabout

- The vehicle deflection for the northern, western and eastern approaches should be increased to decrease the vehicle speeds to around 30km/hr to improve the safety of this roundabout (current design speeds are around 50km/hr for three approaches).
- The safety of the roundabout should be reassessed one year following the above changes to determine whether the increased vehicle deflection has addressed the safety concerns. If the increased vehicle deflection is successful in reducing the crash rate, then it will prove the principle of the C-roundabout – that roundabout speeds should be reduced for safety.
- The roundabout should be monitored until there is sufficient data to confirm the safety concerns have been addressed.
- The crash history should also be reviewed in one year's time, to check if the truck lane-use sign installed on the northern approach has addressed the 'bus/truck versus car' sideswipe crashes on this approach.

3.4 Capacity of the Margan Ave/Hutchinson Ave roundabout

The Margan Ave/Hutchinson Ave roundabout was studied to assess the capacity implications of converting single-lane roundabouts into small double-lane roundabouts without changing the kerb lines (thus at a low cost). At this roundabout the northern and eastern approaches were changed from wide single lanes to two narrow lanes (kerb-to-kerb width of 5.4 metres). Thus additional lanes were provided on two approaches. No changes were made to the kerbs (see figure 3.7 for an illustration of the changes made).

Figure 3.7 Aerial photos for the Margan Ave/Hutchinson Ave roundabout prior to and following reconstruction in November 2007



The installation of additional lanes on the northern and eastern approaches significantly reduced the queuing on these approaches and approximately doubled the capacity of both, thus significantly improving the capacity of the roundabout.

We found that the lane utilisation on the eastern approach was not equal, with more vehicles using the inner lane to travel straight through than the kerb lane. As a result the capacity had not increased as much as it would have if the lane utilisation was equal. However, the capacity of this approach was still improved at very low cost, as there was no need to alter the kerbs.

3.4.1 Conclusions regarding the capacity of Margan Ave/Hutchinson Ave roundabout

The change in the capacity of this roundabout demonstrated the benefit of converting from a wide single lane to two narrow lanes. The capacity of a single-lane roundabout can be improved (almost doubled, depending on lane utilisation of the two-lane approaches), at a very low cost by converting to the two narrow lanes design.

4 Overall conclusions

4.1 The C-roundabout (Palomino Dr/Sturges Rd roundabout)

Study of this C-roundabout led to the following conclusions:

- Multi-lane roundabouts can be designed for 99 percentile cars and may require other vehicles (but not buses) to use mountable areas. Construction costs will be considerably less than a standard multi-lane roundabout (ie 25% of the cost).
- The C-roundabout has proved to be a very economic design that improves conditions for cyclists, pedestrians and motorists at multi-lane roundabouts.
- It is important to ensure the C-roundabout is designed and installed correctly. As it is a very tight design (ie for two 99 percentile cars), any small errors in width, marking and signs can create problems.
- As the C-roundabout is a new design, it is expected that further refinement (eg in the road markings and signs) should continue in improving the design.

4.1.1 Safety

- The C-roundabout was successful in reducing vehicle speeds to 30km/hr (85th percentile speed), which is close to the speed of cyclists.
- The lower operating speed makes the roundabout safer for cyclists.
- The crash history and conflict analysis indicated that there was no change in safety when converting the standard multi-lane roundabout to the C-roundabout, although more years of crash data are required to confirm this.
- Due to the low speeds (around 30km/hr), the C-roundabout has improved safety for all road users, particularly vulnerable road users (pedestrians and cyclists). Speeds are restricted to 30km/hr at the entry and exit, which is where pedestrian crossings are located. At speeds less than 30km/hr, deaths or serious crashes are rare.

4.1.2 Capacity

4.1.2.1 Capacity of the Palomino Dr/Sturges Rd C-roundabout

- The installation of the C-roundabout at this uncongested site had little impact on capacity (based on SIDRA and on-site measurements of the operation).
- The capacity implications of converting an existing multi-lane roundabout into a C-roundabout were difficult to assess at the Palomino Dr/Sturges Rd site because of low traffic flows, very little queuing and stop-line delay, and very few congested periods.
- SIDRA modelling:
 - For an uncongested roundabout, SIDRA indicates that converting an existing multi-lane roundabout into a C-roundabout has very little impact on the delay, the degree of saturation and the design life.

- SIDRA calculates a small increase in the critical gap and follow-up headway because of the geometry of the C-roundabout. This could not be confirmed by on-site measurements (gap and follow-up headway), because of insufficient congested periods.
- Trucks/buses did not significantly impact the approach capacity because of the low percentage of trucks/buses and little queuing on the two-lane approaches.
- On-site observation and measurements – regression analysis
 - The measurements of the entry flow and circulating flow suggested there was a drop in capacity for the C-roundabout design when the circulating flows were less than 878veh/hr, and an increase in capacity when circulating flows were greater than 878veh/hr – although the R^2 (coefficient of determination) value indicated that the regression equation for the entry flow to circulating flow was not a good fit ($R^2 < 0.5$).
 - There was insufficient data from the on-site measurements to statistically conclude whether the capacity of the Palomino Dr/Sturges Rd C-roundabout was better or worse than the previous roundabout.
 - Trucks and buses did not have an adverse impact on the capacity of the Palomino Dr/Sturges Rd C-roundabout (low percentage of trucks/buses).
 - Further sites would need to be reviewed before conclusive results could be obtained.
- Delay measurements
 - Converting the multi-lane roundabout to a C-roundabout had no significant impact on the delays.

4.1.2.2 Impact of trucks/buses on C-roundabout approaches

The capacity of the Palomino Dr/Sturges Rd C-roundabout was not impacted by trucks/buses as the numbers were very low at this site. Trucks/buses may impact on C-roundabout approach capacity, as they are required to straddle both lanes (thus blocking access to one lane); however, they are unlikely to have a significant impact as heavy-vehicle numbers are usually low in peak periods. The amount of impact that trucks/buses could have on the capacity is expected to depend on the following factors:

- Queues and lane utilisation on the approach – it is anticipated that the greater the difference between approach-lane queue lengths, the greater the impact trucks/buses will have on the capacity of the approach. Thus, if there is low utilisation of one lane then the impact of the truck/bus would need to be taken into account.
- Proportion of trucks/buses – the higher the proportion of trucks/buses, the more likely they will negatively impact the capacity of the approach.

4.1.2.3 S-Paramics modelling of the C-roundabout

- The C-roundabout can be modelled in S-Paramics, except difficulties were encountered in modelling the trucks straddling both lanes. Solutions to overcome this problem were suggested by SIAS Paramics Support (UK), but further research would be needed to confirm whether these methods would be appropriate.
- There did not appear to be much difference between the videos of the on-site operation and the S-Paramics model for the peak 2 hours, suggesting that S-Paramics would be adequate for modelling the C-roundabout provided there was adequate capacity (degree of saturation less than 0.6) and low truck flows (less than 2.5%). If there was less capacity and truck flows were higher, an alternative simulation model such as VISSIM may be more suitable.

4.1.3 Road users' impressions of the C-roundabout (cyclists, pedestrians and car drivers)

- The cyclists who cycled through the roundabout were all in support of the C-roundabout, and found it easier to use, safer, better than the previous roundabout and wanted to see more C-roundabouts installed.
- Pedestrians were positive about the C-roundabout and found it safe for pedestrians, better than the previous roundabout, and easy to cross now that the crossing distances were narrower.
- Car drivers were negative about the C-roundabout and found it tight and slow, and would prefer a wider and easier-to-use roundabout. The drivers' impression may have changed since this research, as two more C-roundabouts have been installed and are operating well, with no public complaints.

4.2 Single-lane roundabout changed to have two narrow lanes (Margan Ave/Hutchinson Ave roundabout)

Single-lane roundabouts can be converted to narrow two-lane roundabouts at a very low cost compared with the standard multi-lane roundabout design, and can be constructed within the same road reserve as the single-lane roundabout.

It should be noted that the reconstruction of the Margan Ave/Hutchinson Ave roundabout did not comply with all of the C-roundabout design principles, as it did not involve increasing the vehicle deflection to slow down vehicle speeds through the roundabout to around 30km/hr (the design speed for the roundabout was approximately 50km/hr).

4.2.1 Safety

- There was a significant increase in crashes (injury and non-injury) at this roundabout, although this is to be expected when changing from a single-lane roundabout to a two-lane roundabout.
- It is possible that by increasing the vehicle deflection and reducing the vehicle speeds to around 30km/hr that the crash rate may reduce to that of a single-lane roundabout.
- It may not be advisable to install a narrow double-lane roundabout without decreased vehicle speeds at other sites until the safety concern have been addressed.
- If the increased vehicle deflection is successful in reducing the crash rate, then it will prove the principle of the C-roundabout – that roundabout speeds should be reduced for safety. That is, the two-lane C-roundabout may be as safe as a single-lane roundabout.

4.2.2 Capacity

The capacity of a single-lane roundabout can be improved (almost doubled, depending on the lane utilisation of two-lane approaches) at a very low cost by converting to the 'two narrow lanes' design.

5 Recommendations and further research

5.1 C-roundabout

The principles applied to the C-roundabouts in order to reduce approach and circulating speeds should be considered in other locations where a more cyclist-friendly layout is desirable – ie where cyclists form a significant proportion of the local network traffic. However, it is important to note that an important contribution to the safe and efficient operation of a roundabout is that of a similar treatment on all approach legs, producing a well-balanced intersection. Further research into the key features of the C-roundabout design should be undertaken.

5.1.1 Safety:

- As two new C-roundabouts have been constructed and are in operation in Auckland, and this should provide enough data to conclusively assess the safety of the C-roundabout, the safety of the C-roundabout should be reviewed in one or two years' time.
- The safety performance of the Palomino Dr/Sturges Rd C-roundabout should be reviewed again in one to two years' time (ie when it will have a crash history of five years), to determine whether this C-roundabout is safer than the previous standard roundabout.

5.1.2 Capacity

- Determine whether the critical gap and follow-up headways calculated by SIDRA are correct for the C-roundabout situation – more conclusive results for congested conditions could be obtained from the two new C-roundabouts constructed in Auckland.
- Undertake further entry flow and circulating flow measurements at a C-roundabout with higher flows and with more periods of congestion, such as the two new C-roundabouts in Auckland. This would enable a stronger relationship between entry and circulating flow to be established and thus evaluate the capacity of the C-roundabout using regression analysis. (There was an indication that there is a drop in capacity when circulating flows are low and an increase in capacity when circulating flows are high.)
- Determine whether doubling of the truck numbers on the C-roundabout approaches in SIDRA modelling is a reasonable method to approximate their impact on capacity, as long as there is not significant queuing on the approaches. To do this the author of SIDRA should be consulted, and further on-site observations should be undertaken at C-roundabouts that have higher traffic flows.
- Micro-simulation modelling:
 - S-Paramics modelling: Assess the two solutions for modelling trucks straddling both lanes recommended by SIAS Paramics Support (UK).
 - VISSIM modelling: Assess VISSIM's capabilities for modelling the C-roundabout including trucks straddling both lanes. It appears that VISSIM may be able to model the C-roundabout more appropriately.
 - From the above further research, a conclusion could be made as to which micro-simulation tool is the most appropriate for modelling the C-roundabout.

- Investigate the impact trucks/buses have on capacity where there is a large difference between approach-lane queues in congested conditions eg at the Parrs Cross Rd/Seymour Rd site.

5.1.3 Road users' impression of the C-roundabout

- Car drivers should be educated about the benefits of the C-roundabout, ie the improved safety for cyclists. They should also be told about the cyclist's overwhelming support for the C-roundabout and that the cyclists would like to see more of them installed.
- Further research should be undertaken to determine whether car drivers still have a negative impression of the C-roundabout in six months' time – it is likely that car drivers will get used to driving through the tighter and slower roundabout, and so their support for the C-roundabout may improve.
- If car drivers' impressions of the C-roundabout does not improve, then further research could be done to investigate increasing the lane widths to make the C-roundabout more comfortable for drivers, but without compromising the design principles of the C-roundabout of reducing vehicle speeds for cyclist safety. It may be possible to increase the clearance between the cars (99 percentile) from 0.5m to 1m to improve car drivers' comfort when travelling through the roundabout.

5.2 Single-lane roundabout changed to have two narrow lanes

Single-lane roundabouts can be converted to narrow two-lane roundabouts for capacity reasons at low cost compared with that of the standard design. Further research on the safety implications of this conversion is needed. The following is recommended for the Margan Ave/Hutchinson Ave roundabout:

- The vehicle deflection for the northern, western and eastern approaches should be increased to decrease vehicle speeds to around 30km/hr.
- The safety of the roundabout should be reassessed one year following the above changes to determine whether the increased vehicle deflection has addressed the safety concerns. If the increased vehicle deflection is successful in reducing the crash rate, then it will prove the principle of the C-roundabout – that speeds should be reduced for safety.
- The roundabout should be monitored until there is sufficient data to confirm the safety concerns have been addressed.
- The crash history should be reviewed in one year's time to check whether the truck lane-use sign installed on the northern approach has addressed the bus/truck versus car sideswipe crashes on this approach.

6 References

- Austrroads (1993) *Guide to traffic engineering practice part 6 – roundabouts*. Sydney: Austrroads Incorporated. 86pp.
- Austrroads (2009a) *Guide to road safety part 8: treatment of crash locations*. Sydney: Austrroads Incorporated. 151pp.
- Austrroads (2009b) *Guide to road safety part 4b: roundabouts*. Sydney: Austrroads Incorporated. 96pp.
- Campbell, D, I Jurisich and R Dunn (2006) Improved multi-lane roundabout designs for cyclists. *Land Transport NZ research report 287*. 140pp.
- Campbell, D, I Jurisich and R Dunn (2012) Improved multi-lane roundabout designs for urban areas. *NZ Transport Agency research report 476*. 284pp.
- Daniels, S, T Brijs, E Nuyts and G Wets (2009) *Design types of cycle facilities at roundabouts and their effects on traffic safety: some empirical evidence*. Velo-city, Brussels: Tour & Taxis. 10pp.
- Institute of Transportation Engineers (2000) *Manual of transportation engineering studies*. HD Robertson (Ed), JE Hummer (Asst Ed), DC Nelson (Asst Ed). Washington, DC: Institute of Transportation Engineers. 514pp.
- Robinson, B, L Rodegerdts, W Scarborough, W Kittelson, R Troutbeck, W Brilon, L Bondzio, K Courage, M Kyte, J Mason, A Flannery, E Myers, J Bunker and G Jacquemart (2000) Roundabouts: an informational guide. *US Department of Transportation Federal Highway Administration Publication No. FHWA-RD-00-067*. 126pp.

Appendix A Speed survey for the Palomino Dr/Sturges Rd roundabout

A.1 Speed survey

A speed survey was undertaken at the Palomino Dr/Sturges Rd roundabout before and after it was converted to a C-roundabout. The following sections include a description of the methodology and the results of the survey.

The sections are as follows:

- 1 Methodology
- 2 Movement numbering
- 3 Movement distances
- 4 Sample size requirement
- 5 Speed survey results.

A.1.1 Methodology

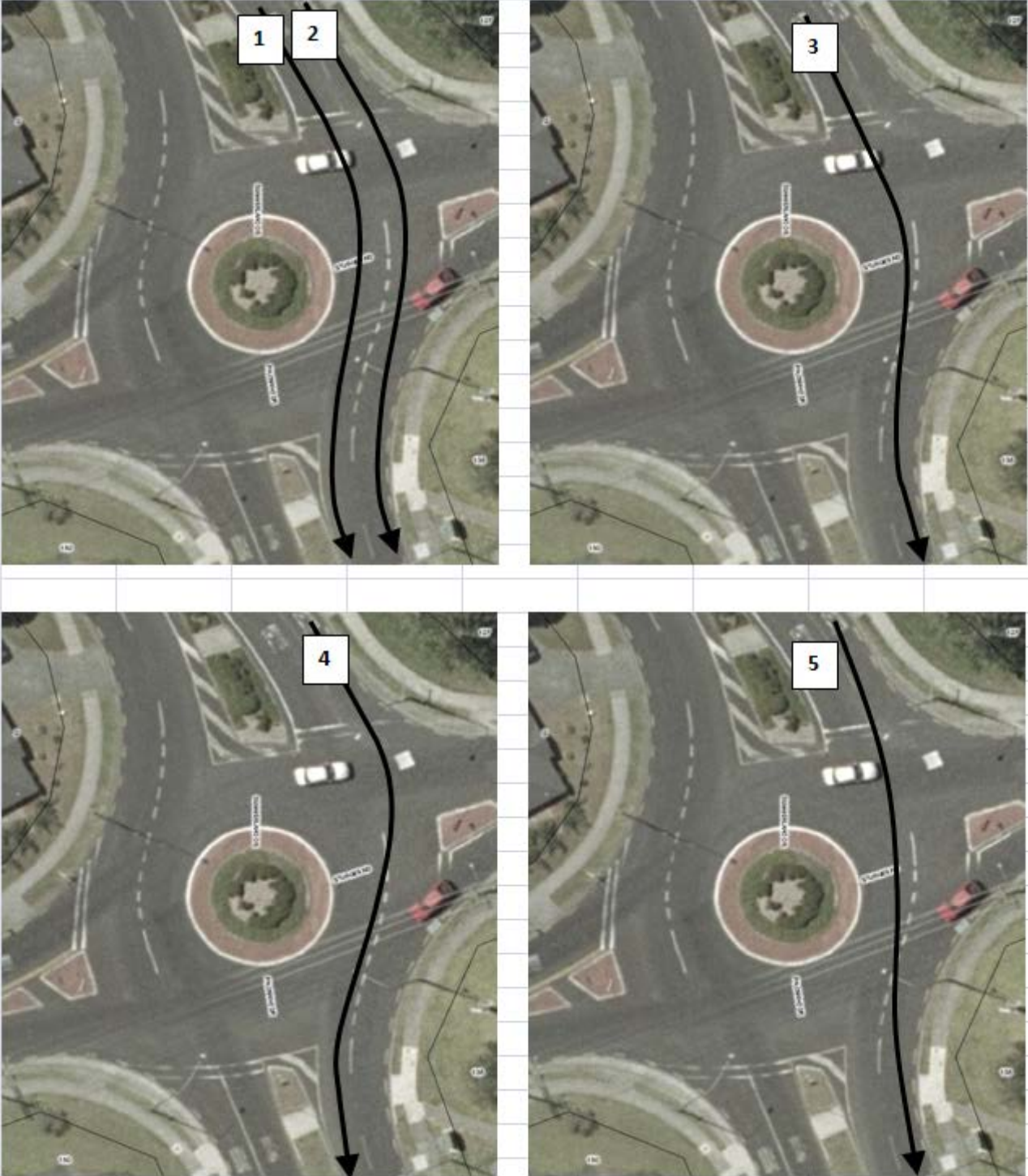
- Video surveys (before and after the roundabout was converted to a C-roundabout) were conducted from 7.30-9am and 2.30-6pm. Figure A.1 shows the view from the camera.
- The videos were then used to record the vehicle speeds through the roundabout. Only the speeds of vehicles that travelled straight through the roundabout without being impeded were measured (ie freely flowing vehicles). For these vehicles, the time that they took to travel through the roundabout, from the limit line to the exit of the roundabout, was measured. This travel time, the direction of travel (eg north to south) and the path that the vehicle travelled was recorded.
- The various vehicle paths were named as different movements – see figure A.2 for an illustration of the movements observed.
- For each of the movements, the distance was estimated using the AutoCAD drawings of the roundabout – see figures A.3 and A.4 for the various movements and their distances.
- The speed of each unimpeded through vehicle was then calculated using the travel time and the movement distance.
- The average and 85th percentile speeds for each direction of travel was then calculated, ie for the north-to-south, south-to-north, east-to-west and west-to-east directions of travel.
- The standard deviation for the speed measurements was also calculated. This was used to determine if the sample size was adequate, and what level of confidence and permitted error the calculated speeds were likely to be, based on the sample size.

Figure A.1 Camera view for video survey done after Palomino Dr/Sturges Rd roundabout was converted to a C-roundabout



A.1.2 Movement numbering

Figure A.2 Example of movement numbering, in this case for the north-to-south direction of travel

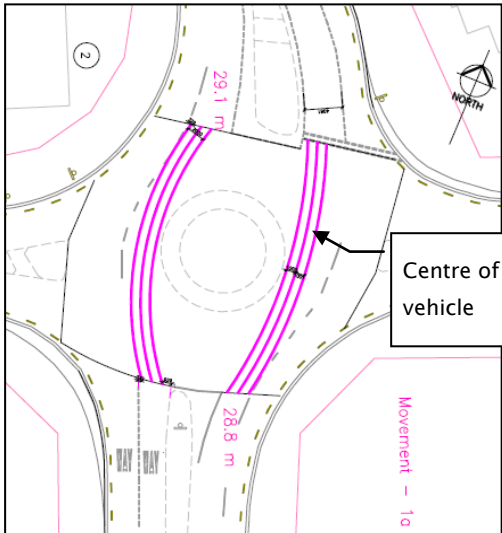


A.1.3 Movement distances

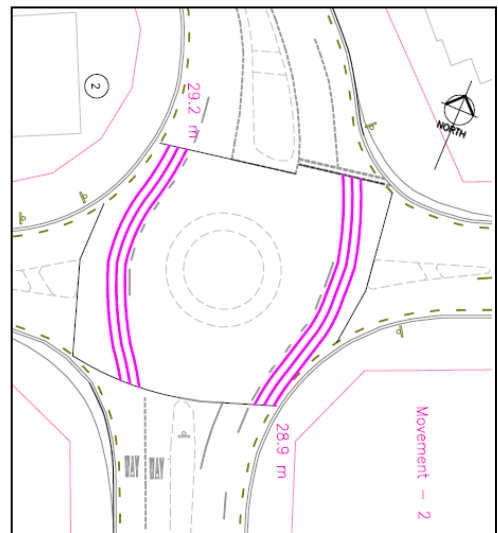
Figure A.3 Movement distances for BEFORE roundabout was converted

North-to-south, and south-to-north movements (movement 4 has been omitted as it was not observed)

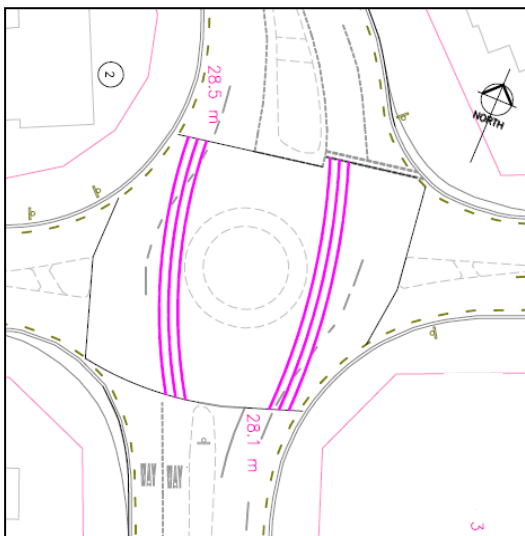
Movements 1



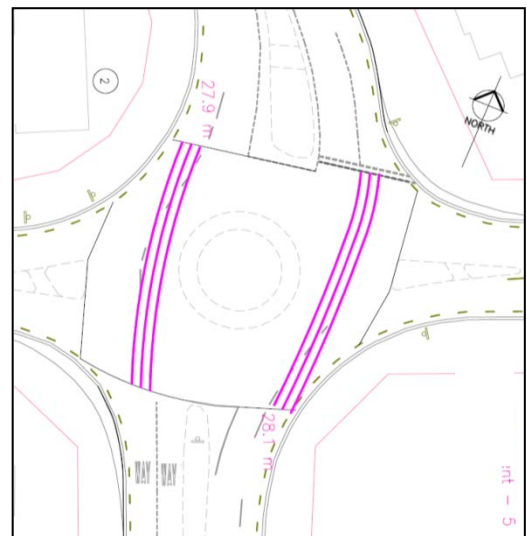
Movements 2



Movements 3



Movements 5



West-to-east and east-to-west movements

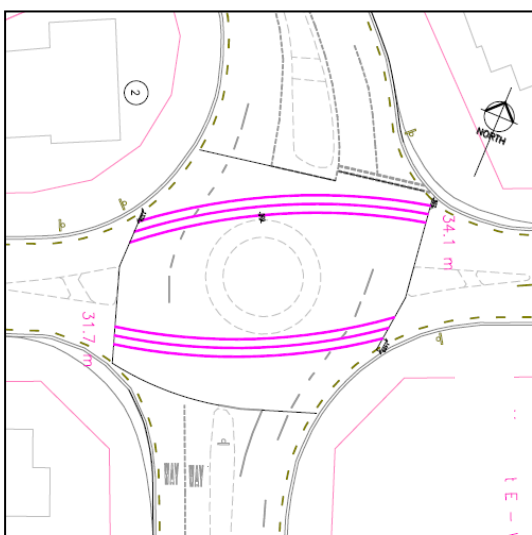
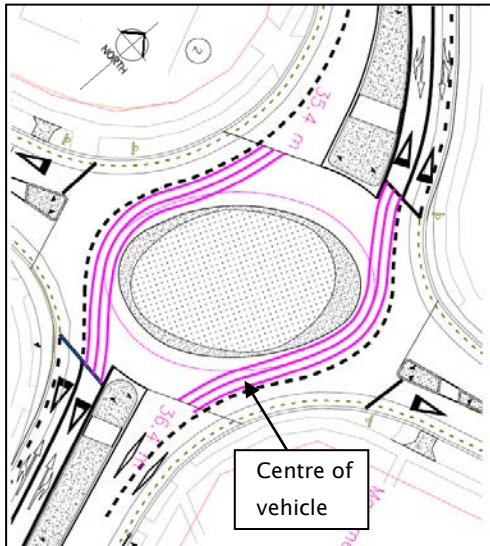
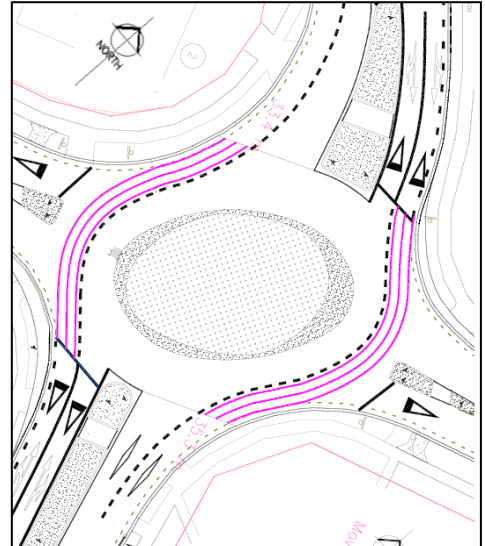


Figure A.4 Movement distances for AFTER roundabout was converted
North-to-south, and south-to-north movements (movement 4 has been omitted as it was not observed)

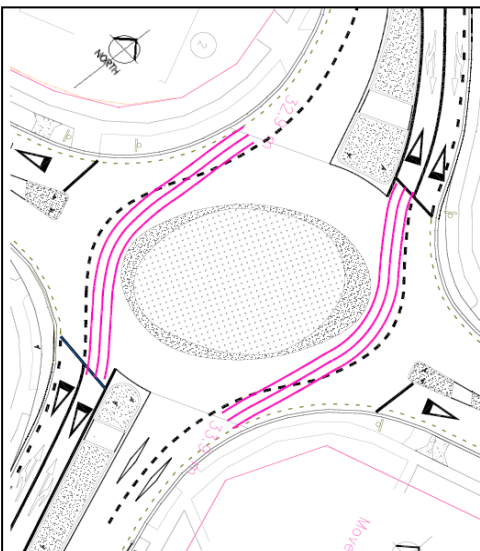
Movements 1



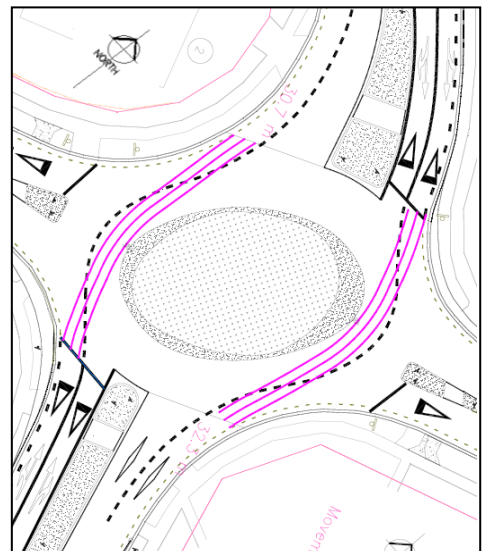
Movements 2



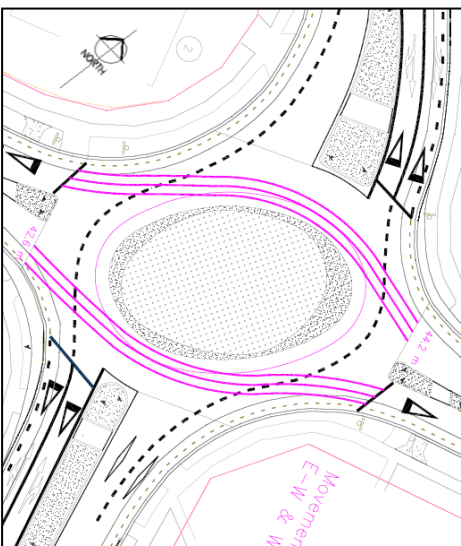
Movements 3



Movements 5



West-to-east and east-to-west movements



A.1.3.1 Summary of movement distances

	Movement	Movement distance (m)	
		BEFORE	AFTER
North to south	1	28.8	36.4
	2	28.9	35.3
	3	28.1	33.9
	5	28.1	32.3
South to north	1	29.1	35.4
	2	29.2	33.4
	3	28.5	32.9
	5	27.9	30.7
West to east		34.1	44.2
East to west		31.7	42.6

A.1.4 Sample size requirement

For calculating 85th percentile, 95th percentile and mean speeds, the number of samples required for a desired confidence level and permitted error is given by the formula below. This is referenced from the *Manual of transportation engineering studies* (Institute of Transportation Engineers 2000, Chapter 3).

$$N = \frac{S^2 K^2 (2+U^2)}{2E^2} \quad \text{(Equation A.1)}$$

where:

N = minimum number of measured speeds

S = estimated sample standard deviation (km/hr)

K = constant corresponding to desired confidence level

E = permitted error in the speed estimate (km/hr). Typical permitted errors range from +1.0 to +5.0

U = constant corresponding to the desired percentile speed

Table A.1 Constant (K) corresponding to desired confidence level

Confidence level (%)	Constant, K
90	1.64
95	1.96
95.5	2
99.7	3

Table A.2 Constant (U) corresponding to desired percentile speed

Percentile speed	Constant, U
50th (mean)	0
85th	1.04
95th	1.64

A.1.4.1 The BEFORE speed survey

The BEFORE sample speed survey had the following standard deviations per direction of travel.

Table A.3 Standard deviations for the BEFORE sample speed survey

	North to south	South to north	West to east	East to west
Standard deviation	4.12	4.38	3.95	5.33

Using the above standard deviations, the following sample size requirements for each direction of travel was calculated. The sample size requirement depends on the percentile speed being calculated, the permitted error in the speed estimate and the desired confidence level.

Table A.4 Sample size requirement based on percentile speed, permitted error and desired confidence level

			Sample size required for speed survey for the following travel directions			
Percentile speed	Permitted error in speed estimate (km/hr)	Confidence level (%)	North to south	South to north	West to east	East to west
85th	+/-2	90%	18	20	16	29
		95%	25	28	23	42
	+/-1	90%	70	79	65	118
		95%	101	114	92	168
		95.5%	105	118	96	175
99.7%	236	266	216	394		
95th	+/-2	90%	27	30	25	44.81
		95%	38	43	35	64.01
	+/-1	90%	107	121	98	179.25
		95%	153	173	140	256.03
Mean (50th)	+/-2	90%	11	13	10	19
		95%	16	18	15	27
	+/-1	90%	46	52	42	76
		95%	65	74	60	109
Sample size obtained for the BEFORE speed survey			102	120	70	160

Thus, for north to south, the 85th percentile speed calculated from the sample should be within the permitted error of 1kph and of 95% confidence.

For south to north, the 85th percentile speed calculated from the sample should be within the permitted error of 1kph and of a 95.5% confidence.

For west to east and east to west, the 85th percentile speed calculated from the sample should be within a permitted error of 1kph and of a 90% confidence.

A.1.4.2 The AFTER speed survey

The AFTER sample speed survey had the following standard deviations per direction of travel.

Table A.5 Standard deviations for the AFTER sample speed survey

	North to south	South to north	West to east	East to west
Standard deviation	3.52	2.50	3.48	4.19

Using the above standard deviations the following sample size requirements for each direction of travel was calculated. The sample size requirement depends on the percentile speed being calculated, the permitted error in the speed estimate and the desired confidence level.

Table A.6 Sample size requirement based on percentile speed, permitted error and desired confidence level

			Sample size required for speed survey for the following travel directions			
Percentile speed	Permitted error in speed estimate (km/hr)	Confidence level (%)	North to south	South to north	West to east	East to west
85th	+/-2	90%	13	6	13	18
		95%	18	9	18	26
	+/-1	90%	51	26	50	73
		95%	73	37	72	104
		95.5%	76	39	75	108
		99.7%	172	87	168	243
95th	+/-2	90%	20	10	19	28
		95%	28	14	27	40
	+/-1	90%	78	40	76	111
		95%	112	56	109	158
Mean (50th)	+/-2	90%	8	4	8	12
		95%	12	6	12	17
	+/-1	90%	33	17	33	47
		95%	48	24	47	67
Sample size obtained for the AFTER speed survey			160	162	105	105

Thus, for north to south, the 85th percentile speed calculated from the sample should be within the permitted error of 1kph and of 95.5% confidence.

For south to north, the 85th percentile speed calculated from the sample should be within the permitted error of 1kph and of a 99.7% confidence.

For west to east and east to west, the 85th percentile speed calculated from the sample should be within a permitted error of 1kph and of a 95.5% confidence.

A.1.5 Summary of speed survey results

A summary of the speed survey results are shown in the table, figure and box plots below.

Table A.7 Before and after speed survey results for average, 85th percentile and 95th percentile speeds

Speed survey results for before and after Palomino Dr/Sturges Rd roundabout was changed to C-roundabout design				
	North to south	South to north	West to east	East to west
Average (mean) speed (km/hr)				
Before	29.82	29.85	30.28	31.26
After	26.77	25.09	28.04	30.17
Difference	-3.05	-4.76	-2.24	-1.09
85th percentile speed (km/hr)				
Before	34.22	34.04	34.16	35.83
After	30.22	27.83	31.63	34.87
Difference	-4.00	-6.21	-2.53	-0.96
95th Percentile speed (km/hr)				
Before	35.63	37.03	35.74	40.61
After	32.82	28.97	33.25	37.42
Difference	-2.81	-8.06	-2.49	-3.19

Figure A.5 85th percentile speeds before and after the Palomino Dr/Sturges Rd was changed to a C-roundabout

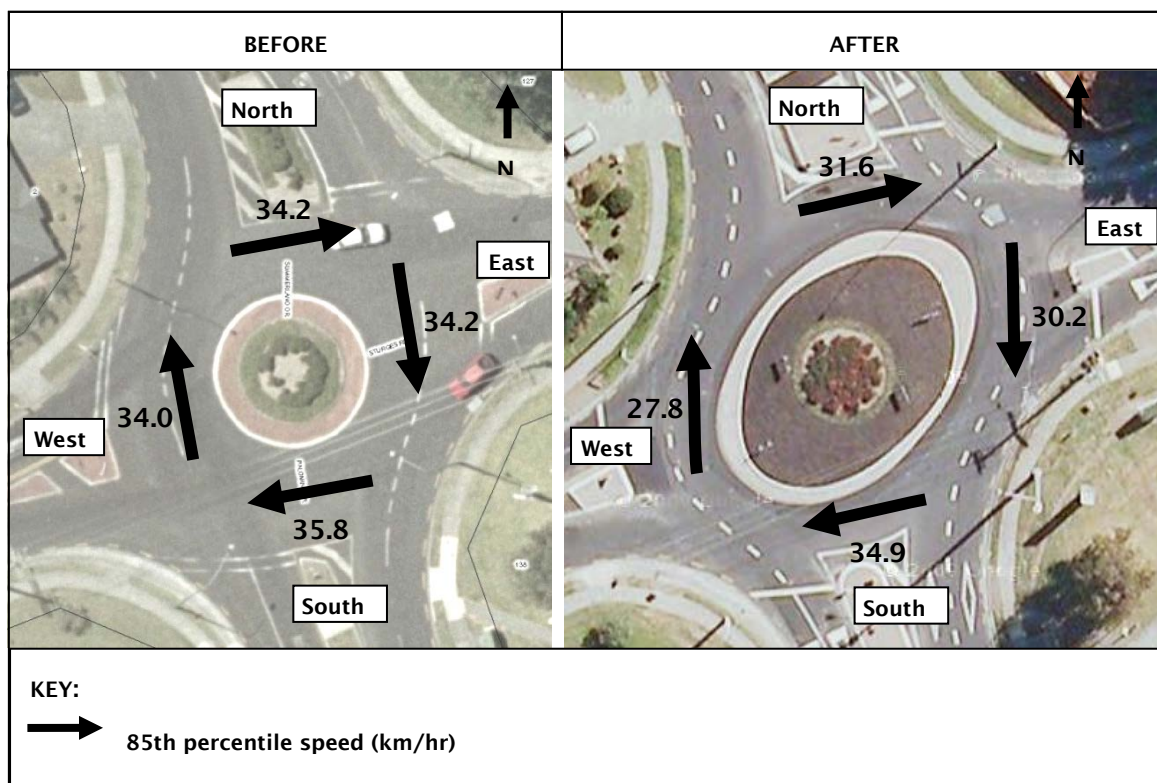


Figure A.6 Box plots of the north-to-south and south-to-north vehicle speeds, before and after the roundabout was converted to a C-roundabout design

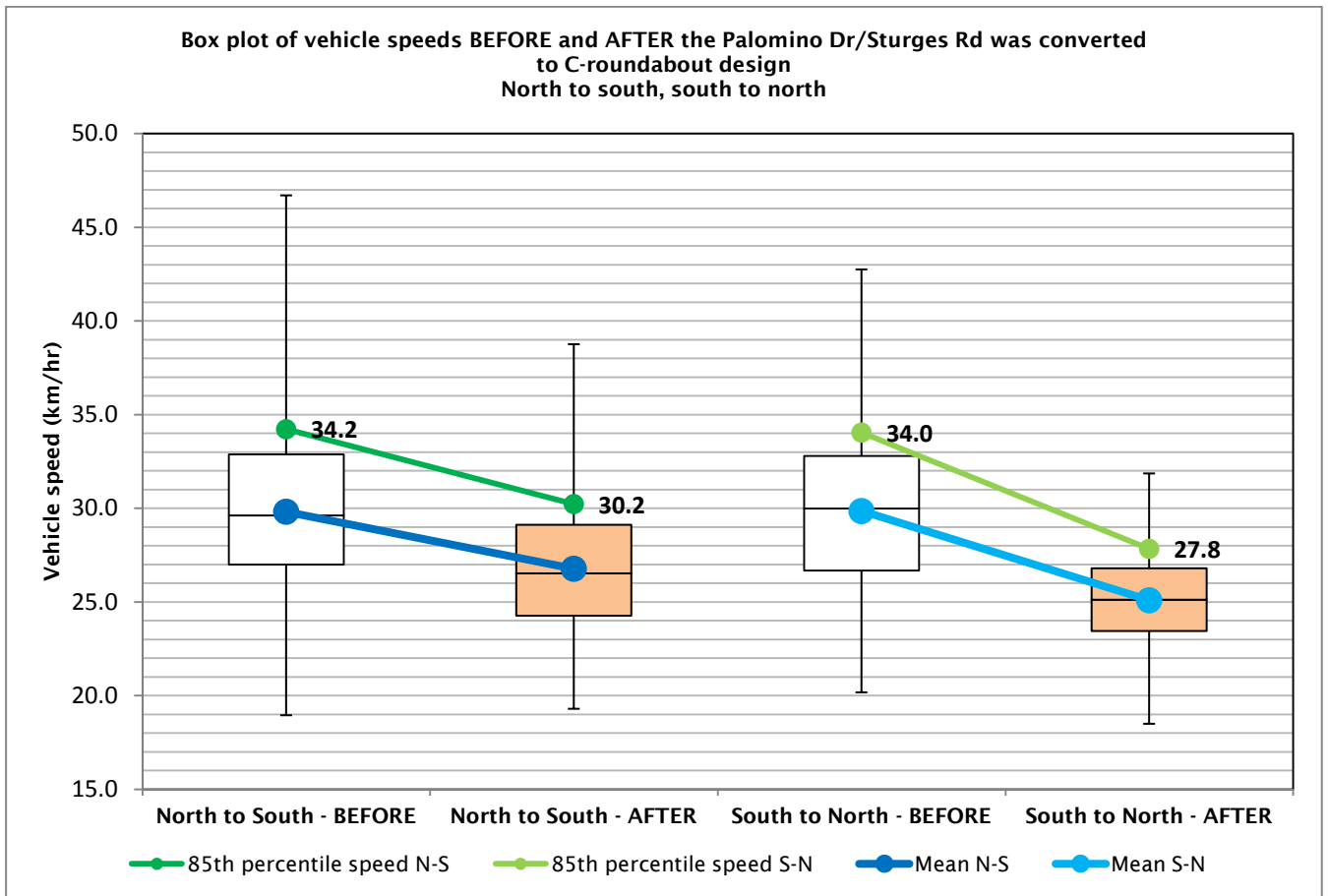
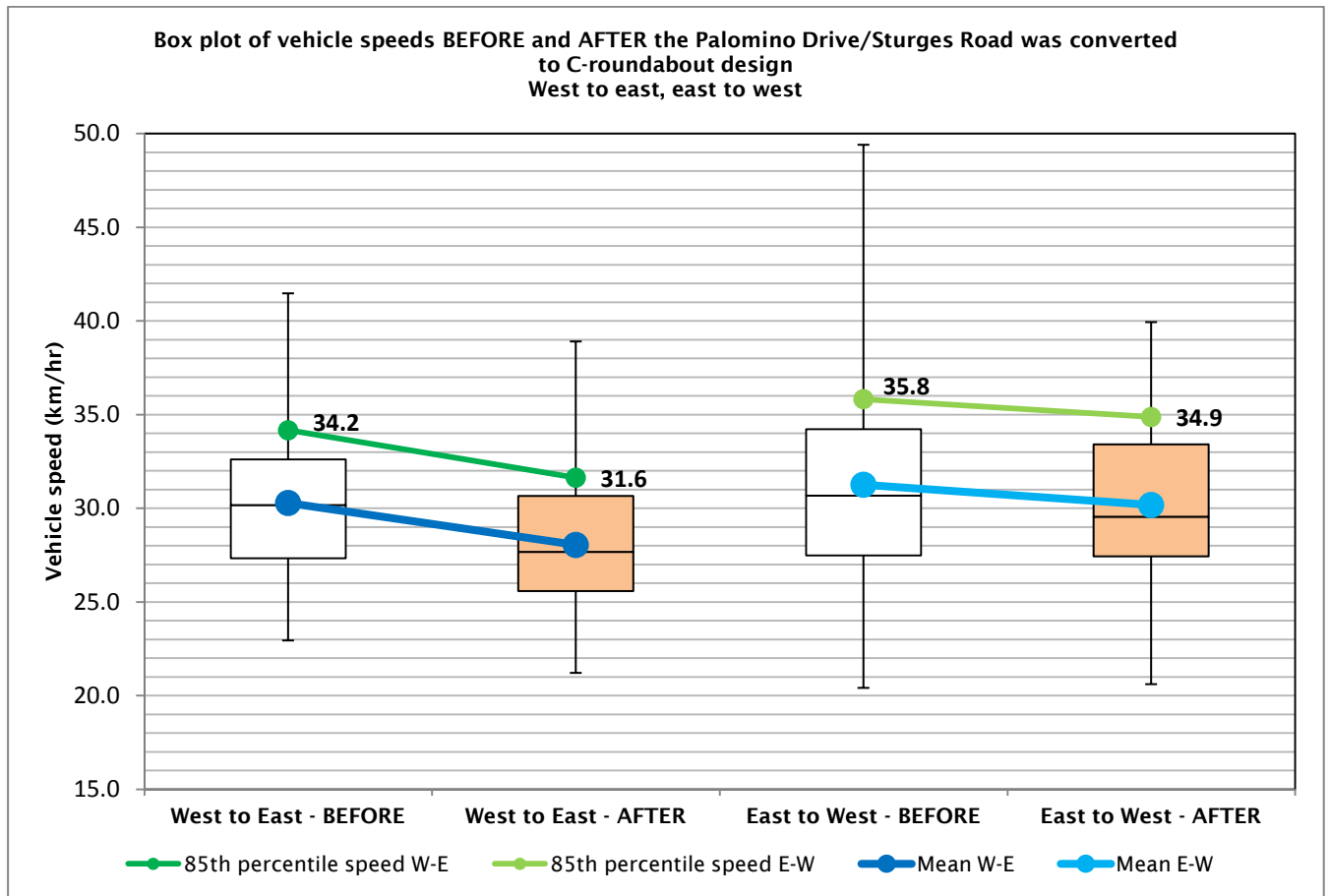


Figure A.7 Box plots of the west-to-east and east-to-west vehicle speeds, before and after the roundabout was converted to a C-roundabout design



Appendix B Cyclist survey for the Palomino Dr/ Sturges Rd roundabout⁸

⁸ Non-standard signs and markings, which do not comply with the Land Transport Rule: Traffic Control Devices (TCD Rule), have been used in undertaking this research. Refer to page 3 of this report.



Evaluation of the C-Roundabout at Palomino Drive/Sturges Road, Henderson

Traffic Engineering Solutions Limited (TES) is undertaking a research project for the New Zealand Transport Agency (NZTA), evaluating the operation of the C-Roundabout.

The C-Roundabout (Cyclist Roundabout) is a new type of roundabout design which is aimed at improving the safety of adult cyclists at multi-lane roundabouts.

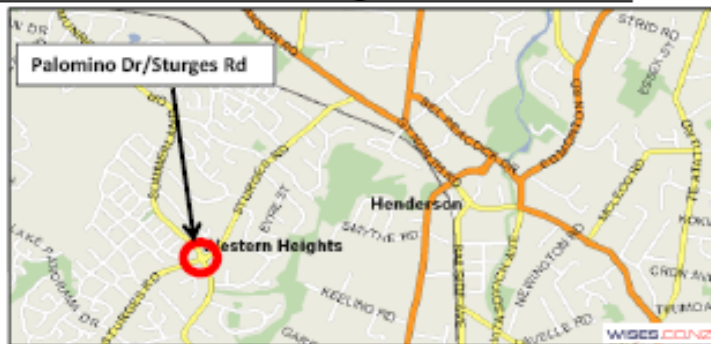
The C-Roundabout is designed to reduce vehicle speeds so that cyclists can more easily mix with circulating traffic. To achieve this, the C-Roundabout has narrow approach lanes and tight circulating geometry.

The C-Roundabout has been constructed at the Palomino Drive/Sturges Road intersection. A key objective of the research is to evaluate cyclist's opinions of the C-Roundabout.

We would appreciate your time and effort if you could cycle through the Palomino Drive/Sturges Road C-Roundabout and then complete the attached questionnaire.

NOTE - THIS SURVEY IS RESTRICTED TO PERSONS 16 YEARS AND OVER.

Location of the Palomino Dr/Sturges Rd C-Roundabout:



Changes made in April 2009 at Palomino Dr/Sturges Rd Roundabout to make it a C-Roundabout:

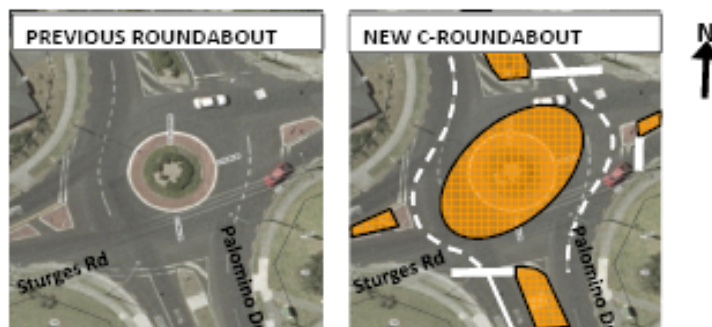
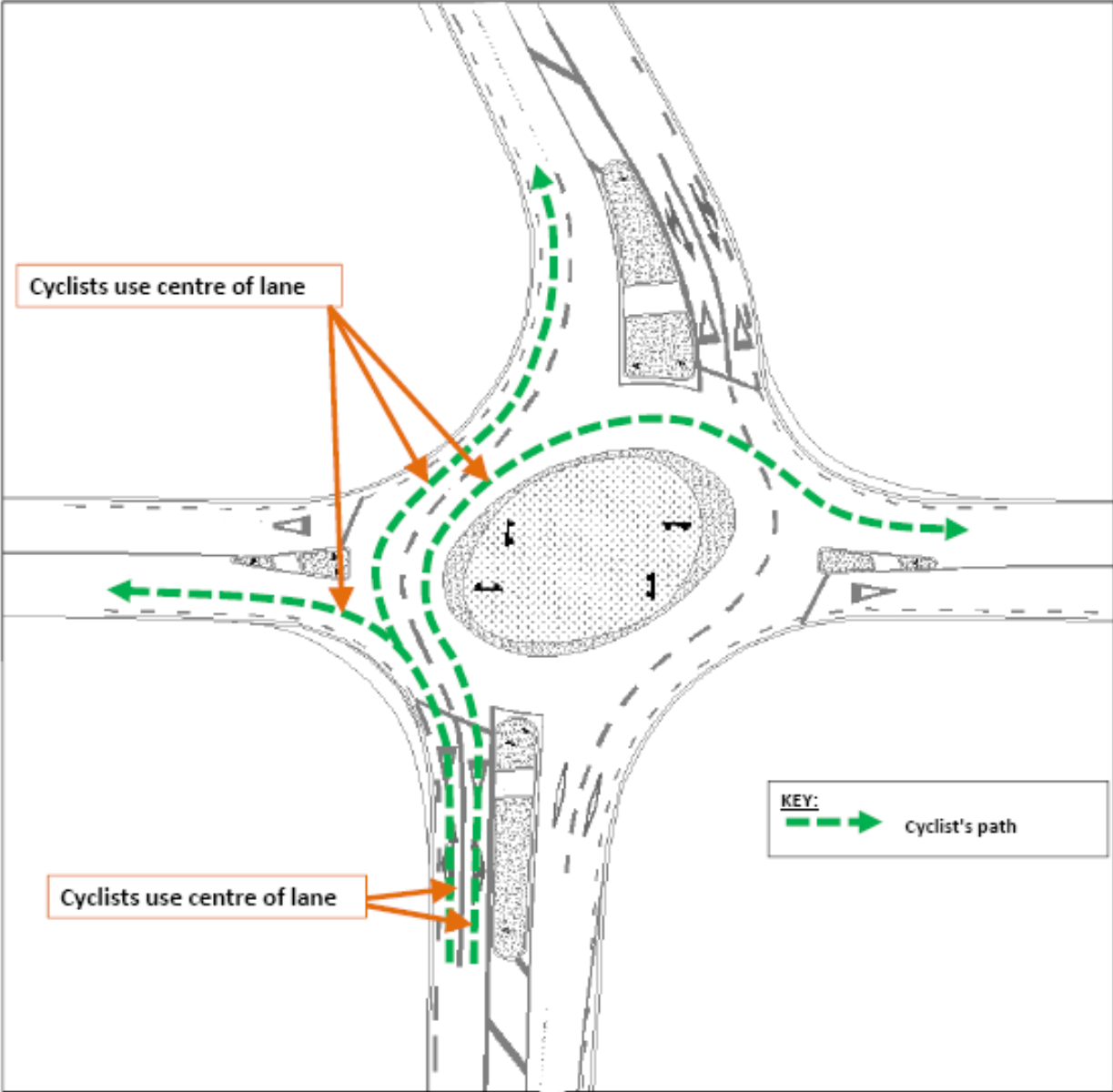


Photo of the newly constructed C-Roundabout at Palomino Dr/Sturges Rd intersection:



Recommended way to use the C-Roundabout

Cyclists travel in the centre of the lanes, on approach to roundabout and in the roundabout.



Questionnaire - please complete after cycling through the C-Roundabout

Please circle your answers, or select from the dropboxes if responding via email.
 If you have difficulty in using this format, please email your details to deborah.asmus@tes.net.nz and we will post you a survey form.

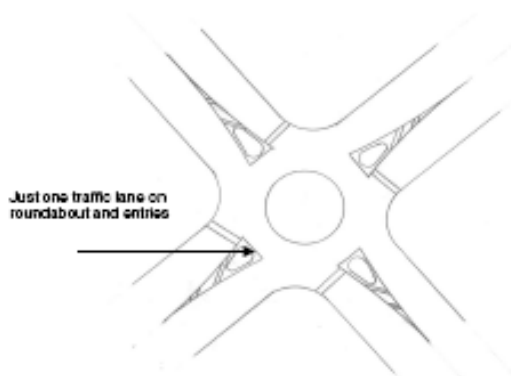
- 1 What is usually the main purpose of your cycling? ▼
- a Commuting
 - b Recreation
 - c Competition
 - d Other (Please specify)

- 2 What level of competence do you consider your on-road riding skills to be? ▼
- a Novice
 - b Intermediate
 - c Experienced

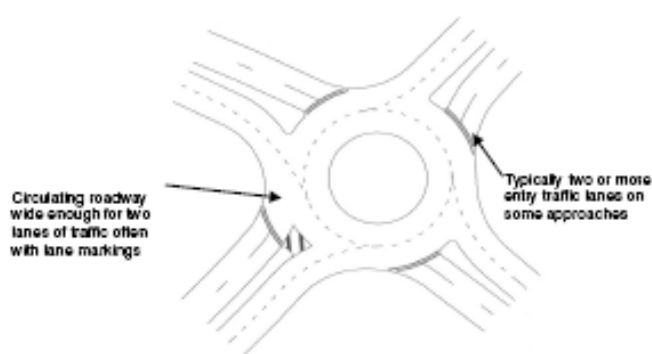
- 3 How many on-road cycle trips would you make each week? ▼
- a 0-2
 - b 3-6
 - c 7-12
 - d >12

- 4 Does your regular cycle route include any roundabouts? ▼
- a Single-lane roundabouts
 - b Multi-lane roundabouts
 - c Both a) and b)
 - d No roundabouts

Typical single-lane roundabout



Typical multi-lane roundabout



- 5 What time and date did you cycle through the Palomino Dr/Sturges Rd C-Roundabout?
- Time: ▼ Day: ▼ Month: ▼ Year: 2009

- 6 What was the weather like when you cycled through the Palomino Dr/Sturges Rd roundabout? ▼
- a Fine and dry
 - b Wet road, but not raining
 - c Light rain
 - d Heavy rain
 - e Other (please specify)

- 7 Have you cycled through the Palomino Dr/Sturges Rd roundabout before it was changed to a C-Roundabout in April 2009? ▼
- a Yes
 - b No

- If yes, how do you compare the old roundabout to the C-Roundabout as a cyclist? ▼
- a Better (safer and easier to use)
 - b Slightly better
 - c No difference
 - d Slightly worse
 - e Worse (less safe and difficult to use)

Comments:

8 Have you cycled through other multi-lane roundabouts before? ▼

a Yes
b No

if **no** - go to question 9
if **yes** - please answer (i) - (iii) below:

(i) Did you find it easier to cycle through the C-Roundabout than other multi-lane roundabouts? ▼

a Definitely easier
b Slightly easier
c About the same
d Slightly harder
e Definitely harder
f Not sure

Comments:

(ii) Did you feel safer cycling through the C-Roundabout than other multi-lane roundabouts? ▼

a Definitely safer
b Slightly safer
c About the same
d Slightly less safe
e Definitely less safe
f Not sure

Comments:

(iii) Would you say that the speed of cars using the C-Roundabout was lower than at other multi-lane roundabouts? ▼

a Much lower
b A little lower
c About the same
d A little higher
e Much Higher
f Not sure

9 Would you like to see more C-Roundabouts installed? ▼

a Yes
b No
c Don't mind

Comments:

10 Do you think the road markings and signs helped you to use the C-Roundabout? ▼


a Yes
b No
c Not sure

Comments:

11 Do you think the road markings adequately communicated to you to cycle in the centre of the lanes? ▼

a Yes
b No
c Not sure
d Didn't see the road markings

Comments:

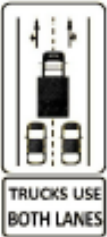


12 General comments of what you think of the C-Roundabout in terms of cyclist riding comfort and safety:

13 Do you think the signs adequately communicated to you that trucks are supposed to straddle both lanes?

a Yes
b No
c Not sure
d Didn't see the sign

Comments: _____



14 How old are you? ▼

a 16-25
b 26-35
c 36-45
d 46-55
e 56-65
f 66 or older

15 Male or female? ▼

a Male
b Female

Would you be able to give us your contact details in case we wish to ask you further questions about your survey responses? (optional, any contact details appreciated)

Name: _____

Address (including city etc): _____

Phone No: _____

Email address: _____

Many thanks for your co-operation.
Please send your response as soon as possible.
To go in the draw to **win a \$100 Bike Central Voucher**, send your response in before **9 November** (proof of age may required on award of prize).
Final closing date for responses is **23 November 2009**.

Send responses to:
Deborah Asmus
Traffic Engineer
Traffic Engineering Solutions Limited

Via Email: deborah.asmus@tes.net.nz
or Post: PO Box 7237, Wellesley Street, Auckland 1010
or Fax: 09 336 1831

Phone number if you have any queries:
DDI: 09 366 7531

Appendix C Pedestrian survey for the Palomino Dr/Sturges Rd roundabout



Dear Sir/Madam

Questionnaire for the New Roundabout at Palomino Dr/Sturges Rd intersection, in Western Heights

Traffic Engineering Solutions Ltd is undertaking a research project for the New Zealand Transport Agency and Waitakere City Council. We are evaluating the new roundabout at Palomino Dr/Sturges Rd intersection.

We are seeking pedestrians' responses to the new roundabout.

We would greatly appreciate your time and effort if you could complete the following questionnaire, your feedback will assist us in evaluating the operation of the new roundabout.

On the following page there is a brief description of the Palomino Dr/Sturges Rd roundabout for your information.

Please post the completed questionnaire to us using the attached free post envelope by 24 June 2010. Alternatively you could email a scanned copy to: info@tes.net.nz.

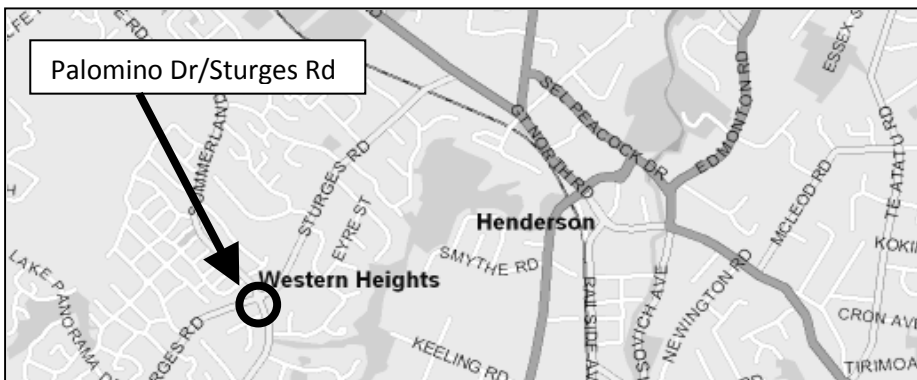
Many thanks,

Traffic Engineering Solutions Ltd

New C-roundabout at Palomino Dr/Sturges Rd intersection

In April 2009 the old roundabout was changed to a new type of roundabout, called a **C-roundabout**. It is designed to reduce vehicle speeds to make it safer for all road users (motorists, cyclists and pedestrians).

Location of the Palomino Dr/Sturges Rd roundabout:



Changes made in April 2009 at Palomino Dr/Sturges Rd roundabout to make it a C-roundabout:



The C-roundabout has a larger central island and narrower lanes to slow vehicles down and make it safer for all road users.



Questionnaire

- 1** Do you think that the new roundabout is better/worse for pedestrians than the previous roundabout?
- Much better
 - Better
 - Same (no different to previous roundabout)
 - Worse
 - Much Worse
 - Not sure
 - Can't remember previous roundabout

And, Why? :

- 2** Have you noticed a change in the speed of vehicles since the new roundabout has been built?
- Much slower
 - Slower
 - Same (no different to previous roundabout)
 - Faster
 - Much faster
 - Not sure
 - Can't remember previous roundabout

Comment:

- 3** Did you notice that the islands on some of the approaches are larger than before the new roundabout was built?
- Yes
 - No
 - Not sure

- 4** Did you feel that the road you crossed was wider/narrower than before the new roundabout was built?
- Much narrower
 - Narrower
 - Same (no different to before)
 - Wider
 - Much wider
 - Not sure
 - Can't remember previous roundabout

Comment:

- 5** Did you find it easy to cross the road at the new roundabout, compared to the previous roundabout?
- Very easy
 - Easy
 - Same (no different to previous roundabout)
 - Difficult
 - Very difficult
 - Not sure

Comment:

- 6** Do you feel that the new roundabout is safe for pedestrians, compared to the previous roundabout?
- Very safe
 - Safe
 - Same (no different to previous roundabout)
 - Unsafe
 - Very unsafe
 - Not sure

Comment:

- 7** Do you have any suggestions for improvements to the roundabout?

- 8** Would you like to see more C-Roundabouts?
- Yes
 - No
 - Not sure
 - Don't understand what a C-roundabout is

Comment:

- 9** Please complete the following:

What is your age?

- 15-25
- 26-35
- 36-45
- 46-55
- 56-65
- 66 or older

Are you Male / Female ?

Thank you for your time !

Appendix D Car driver survey for the Palomino Dr/Sturges Rd roundabout



5 May 2010

Dear Sir/Madam

Questionnaire for the New Roundabout at Palomino Dr/Sturges Rd intersection, in Western Heights

Traffic Engineering Solutions Ltd is undertaking a research project for the New Zealand Transport Agency and Waitakere City Council. We are evaluating the new roundabout at Palomino Dr/Sturges Rd intersection.

We are seeking motorists' responses to the new roundabout. On 7 April 2010 we recorded a sample of cars that travelled through the roundabout and yours was one of them.

We would greatly appreciate your time and effort if you could complete the following questionnaire, your feedback will assist us in evaluating the operation of the new roundabout.

On the following page there is a brief description of the Palomino Dr/Sturges Rd roundabout for your information.

Please post the completed questionnaire to us using the enclosed free post envelope. Alternatively you could email a scanned copy to: info@tes.net.nz.

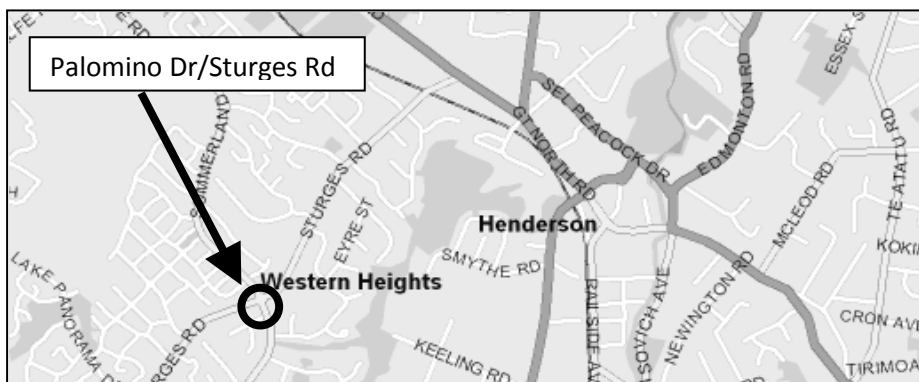
Many thanks,

Traffic Engineering Solutions Ltd

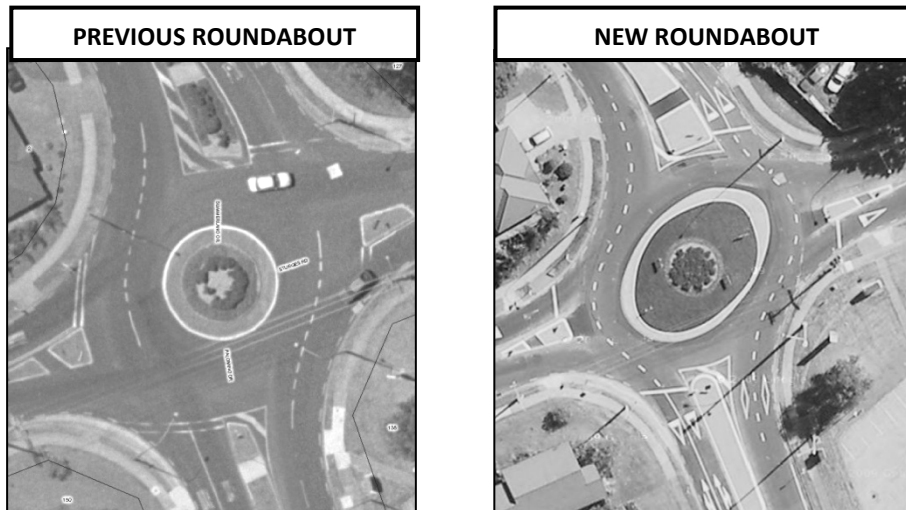
New C-roundabout at Palomino Dr/Sturges Rd intersection

In April 2009 the old roundabout was changed to a new type of roundabout, called a **C-roundabout**. It is designed to reduce vehicle speeds to make it safer for all road users (motorists, cyclists and pedestrians).

Location of the Palomino Dr/Sturges Rd roundabout:



Changes made in April 2009 at Palomino Dr/Sturges Rd roundabout to make it a C-roundabout:



The C-roundabout has a larger central island and narrower lanes to slow vehicles down and make it safer for all road users.

Questionnaire (page 1 of 2)

1 How would you rate your speed travelling through this roundabout compared to other roundabouts?

- Very slow
- Slow
- Same (no different to other roundabouts)
- Fast
- Very fast
- Not sure

Comment:

2 Did you find this roundabout easy to use compared to other roundabouts?

- Very easy
- Easy
- Same (no different to other roundabouts)
- Difficult
- Very difficult
- Not sure

Comment:

3 Did you feel that this roundabout was safe compared to other roundabouts?

- Very safe
- Safe
- Same (no different to other roundabouts)
- Unsafe
- Very unsafe
- Not sure

Comment:

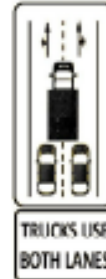
4 How would you describe the lanes on the approach to this roundabout compared to other roundabouts?

- Much narrower
- Narrower
- Same (no different to other roundabouts)
- Wider
- Much wider
- Not sure

Comment:

5 Did you notice the truck sign on the approach to the roundabout?

- Yes
- No
- Not sure



6 On first impressions, what do you think the above truck sign means? (you may circle more than one answer)

- Trucks should straddle (take up) both lanes
- Cars should stay behind trucks
- Trucks should use left or right lane
- Shows cars how to use the lanes
- Cars should overtake trucks
- Not sure
- Other: _____

Note: please don't change any of your answers for questions 1-6 after reading the remaining questions.

7 The approach lanes to the roundabout are narrower than normal, and large trucks and buses are required to straddle both lanes. Cars should stay behind trucks and buses. Which sign below do you think better gets your attention and conveys this message?



- Sign No. 1
- Sign No. 2
- Both the same
- Neither
- Not sure

Comment:

Questionnaire (page 2 of 2)



8 Did you notice the roundabout sign on the approach advising you to drop your speed to 30km/hr?

- a. Yes
- b. No
- c. Not sure



9 Do you think it would be helpful to have a sign in advance of the roundabout saying that it is a C-Roundabout?

- a. Yes
- b. No
- c. Not sure
- d. Don't understand what a C-Roundabout is



Comment:

10 Do you think this roundabout is safer for cyclists compared to other roundabouts?

- a. Yes
- b. No
- c. Not sure

Comment:

11 Did you notice the road marking cycle symbol?

- a. Yes
- b. No
- c. Not sure



12 What do you think the road marking cycle symbol means? (you may circle more than one answer)

- a. Cyclists use centre of the lane, like cars
- b. Motorists look out for cyclists
- c. Do not drive over this symbol
- d. This roundabout is only for cyclists
- e. Not sure
- f. Other: _____

13 Do you have any suggestions for improvements to the roundabout?

14 Would you like to see more C-Roundabouts?

- a. Yes
- b. No
- c. Not sure
- d. Don't understand what a C-roundabout is

Comment:

15 Please complete the following:

What is your age?

- a. 15-25
- b. 26-35
- c. 36-45
- d. 46-55
- e. 56-65
- f. 66 or older

Are you Male / Female ?

Thank you for your time !

Appendix E Preliminary guidelines for the C-roundabout⁹

E.1 Design philosophy

The C-roundabout is an on-road design that improves cyclist safety and amenity by lowering speeds and the available road widths – this means that cyclists and vehicle travel at the same speeds and on the same travel path through the roundabout. The principle of the C-roundabout is for unimpeded through-car speeds to be reduced to around 30km/hr, a speed amenable to cyclists mixing with vehicle traffic. The geometric layout of kerb lines is critical to this aim, and appropriate road marking and signage will assist in the operation of the C-roundabout.

E.2 General principles

The C-roundabout design concept is for a confined geometry for all movements, but still allowing for driver manoeuvring within lanes. Generous widths on the roundabout circulating carriageways and exits will achieve this.

Entries should be wide enough to accommodate two large cars with adequate clearance, but sufficiently narrow to dissuade cars from attempting to pass heavy vehicles. Narrow lanes also encourage cyclists to travel in the centre of the lane, which is desirable.

The circulating carriageway should accommodate two large cars, with comfortable clearances. It also should be wide enough for a single bus (or preferably, a B-train), with adequate clearances from all kerbs.

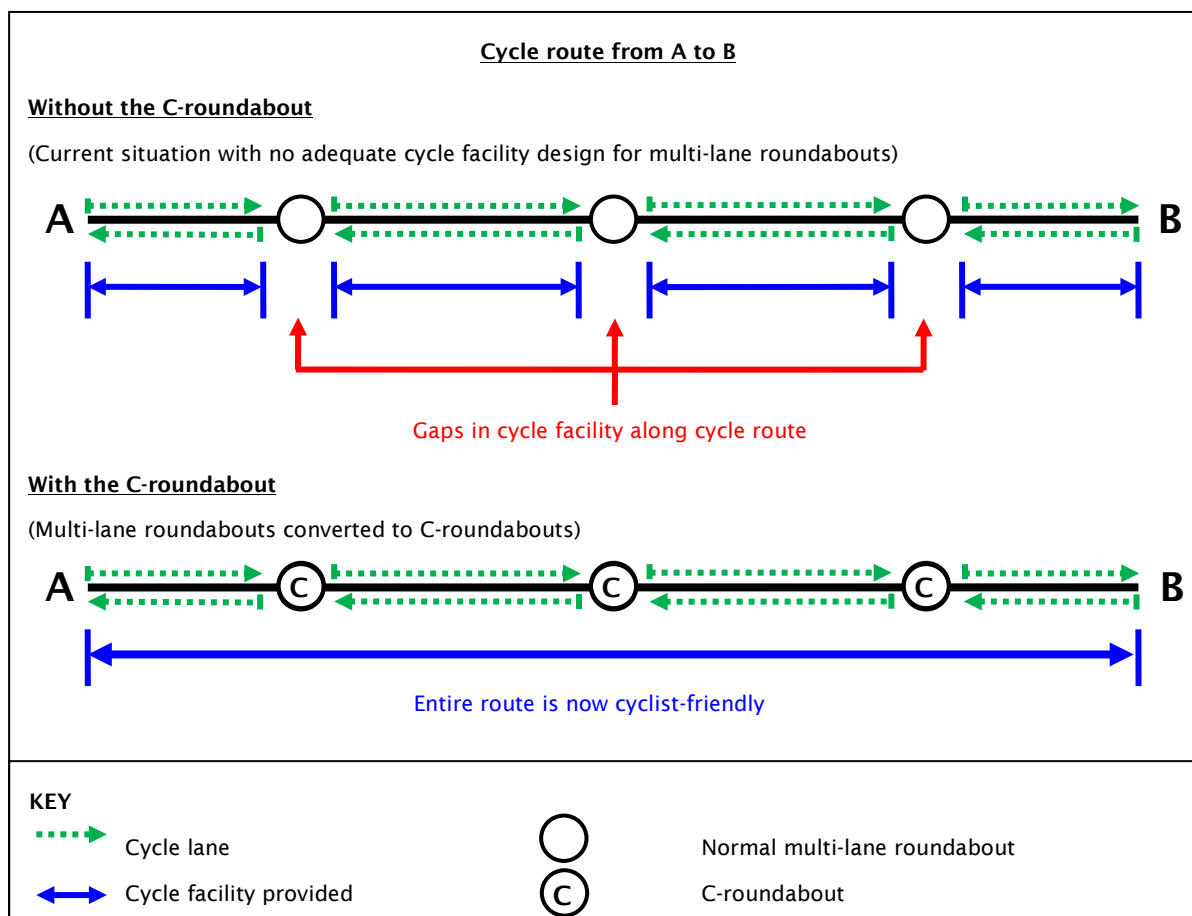
E.3 Where to use the C-roundabout design

The C-roundabout is designed to be installed on cycle routes. As there are currently no adequate cyclist-friendly design solutions for multi-lane roundabouts, cycle facilities typically stop prior to any multi-lane roundabouts on the route. Cyclists are then left to negotiate the multi-lane roundabouts on their own without any improvements to the roundabouts. This results in gaps in the cycle facilities provided on the cycle route. With the use of the C-roundabout design, a multi-lane roundabout can be converted and provide cycle facilities for the entire cycle route (see figure E.1 for an illustration of this).

Austrroads (2009) suggests that cycle lanes could be provided through the multi-lane roundabouts. However, the literature review in an earlier NZTA report (Campbell et al 2006) found that this is not considered to be favourable.

⁹ Non-standard signs and markings, which do not comply with the Land Transport Rule: Traffic Control Devices (TCD Rule), have been used in undertaking this research. Refer to page 3 of this report.

Figure E.1 Cycle route with and without C-roundabouts



Other possible applications of the C-roundabout design include the following:

- At an existing multi-lane roundabout where there are a large number of cyclist crashes or a need to improve cyclist safety, the multi-lane roundabout could be converted to a C-roundabout.
- At a site where an existing single-lane roundabout is going to be converted to a multi-lane roundabout for improved capacity, but there are concerns for the safety of cyclists, a C-roundabout could be installed instead to provide a more cyclist-friendly alternative. The cost of the C-roundabout is likely that be lower than installing a standard multi-lane roundabout, as the kerbs may not need to be altered.
- At a site where a priority intersection is going to be converted to a multi-lane roundabout for improved capacity, but there are concerns for the safety of cyclists, a C-roundabout could be installed instead to provide a more cyclist-friendly alternative.
- At a site where a signalised intersection has a crash problem and a multi-lane roundabout is being considered, a C-roundabout could not only provide a cyclist-friendly option but also a low-speed option and reduce the severity of crashes (with speeds of around 30km/hr there are unlikely to be fatal crashes).
- At a single-lane roundabout where there are cyclist crashes or a need to improve cyclist safety, the C-roundabout concept of increasing vehicle deflection to reduce vehicle speeds could be applied to all

the roundabout approaches – ie apply the principle of the C-roundabout design to a single-lane roundabout.

E.4 Roundabout entry width

The entry width should be 5.4m between kerbs on straights, but wider where required because of tracking. This is to prevent cars attempting to enter adjacent to heavy vehicles, but should also give a minimum acceptable clearance between larger cars that enter side by side. The lane width should not be less than 2.5m on approaches to the roundabout (the minimum legal width). To comply with this, the edge lane next to the approach island should not be installed if the lane becomes less than 2.5m – the kerbs should be painted white instead.

E.5 Vehicle deflection through the roundabout

A maximum path radius of 30–40m is desirable in order to achieve all movements, including left and right turns, and vehicles travelling straight through. This maximum path radius is of particular importance at the roundabout entry, as the majority of cyclist crashes occur here.

A typical layout (shown later in figure E.3) with a 20m diameter central island and a 7m wide circulating carriageway achieves a 40m path radius for through movements and a 33.5m path radius for left-hand turns. It also accommodates a B-train with 0.5m clearances from kerbs.

E.6 Tracking curves

The tracking curves (see figures E.5–11) show how the C-roundabout should be designed. A 99 percentile car should be used for all lanes through the roundabout. A tourist bus should be able to negotiate the roundabout without driving over any mountable kerbs. Large semi-trailers or B-trains may be required to drive over mountable kerbs.

E.7 Mountable areas for heavy traffic

The central island should have a strengthened kerb of up to around 0.5m width that allows for some margin of error by heavy-vehicle drivers. The mountable area may need to be larger, depending upon the tracking. A kerb height of 100mm is recommended.

The kerbs on the roundabout approaches, including median islands, should be constructed to allow for the occasional infringement by a heavy vehicle. If desired, bollards can be installed to prevent this.

E.8 Road marking and signage

Road marking and signage for the C-roundabout are shown in figure E 4.

The following signs are to be installed on the approaches to the C-roundabout:

- a supplementary PW-25 '30' sign should be attached to a 750mm PW-8 'Rotary Junction Ahead' sign. However, attaching PW-25 to PW-8 signs is not currently permitted under the NZTA's (2010) *Manual of traffic signs and markings*
- a truck lane-use sign (still to be approved by the NZTA)

- 'Advance direction signage' (ADS) on approaches and prominent 'Intersection direction signage' (IDS) at the roundabout.

The following road markings are required at the C-roundabout:

- modified Alberta-style markings with additional markings on entries to avoid sideswipe crashes relating to the confined geometry
- edge lines and lane lines on the C-roundabout approaches marked with lines 200mm wide – if the lane width is less than 2.5m on the approach, this edge line might not be possible, in which case the approach island kerb should be painted white instead (the minimum legal width of lanes is 2.5m between marked lines)
- lane guidelines through the C-roundabout marked with lines 200mm wide at a spacing of 1:1 (1 m length, 1 m gap)
- cycle symbol road marking in each lane on the approaches and on the circulating lanes, to make it clear that cyclists should use the centre of the lanes.

It is recommended that all kerbs within 30m of the roundabout be painted reflective white for improved visibility at night.

E.9 Other design issues

E.9.1 Cyclist access to head of queues during congested periods

It is recommended that bypass paths for cyclists be considered to allow cyclists to get to the front of traffic queues in congested conditions. This path should take into account adjacent development and pedestrian activity. Exit and entry ramps for these are discussed in detail in Austroads (1999) *Guide to traffic engineering practice, part 14*, section 4.5.3 'Bicycles'. If there is a reasonable amount of pedestrian activity, then a separated path facility for cyclists may be desirable.

E.9.2 Service covers

Service covers on the circulating carriageway are to be avoided where two-wheeled users are expected to track over them. If they are absolutely necessary, they should have treated surfaces for improved friction in wet conditions. Kerbside stormwater catchpits should be cyclist-friendly.

E.9.3 Lighting

Given the relatively low visibility of cyclists, a satisfactory level of lighting at the roundabout is important. Illumination should at least comply with Australian/New Zealand Standard 1158.1.1 (1997), and use of metal halide fittings is recommended for increased awareness of cyclists and pedestrians.

E.9.4 Sight distance

Sight distance requirements as per Austroads' 1993 *Guide to traffic engineering practice, part 6* section 4.2.7 'Roundabouts' should be provided.

E.9.5 Roundabout approaches with two upstream traffic lanes

For entries with two approach lanes upstream, a merge area prior to the roundabout entry is required. This is to avoid larger vehicles entering the C-roundabout adjacent to other vehicles. This is described in more detail in the NZTA's 2006 report *Improved multi-lane roundabout designs for cyclists*.

E.10 SIDRA modelling guidelines

To improve the accuracy of the SIDRA results, the following are recommended when undertaking SIDRA modelling of the C-roundabout design:

- The negotiation speeds and distances for the through movements should be inputted into SIDRA to ensure that geometric delay is not underestimated, particularly if the roundabout is not circular in shape.
- The entry-lane width, island diameter and circulating width should be inputted into SIDRA.
- Truck/bus numbers could be doubled on an approach to approximate the impact they have on the C-roundabout approaches, as long as there is no significant queuing on the approach (refer to figure E.2 for an illustration). This will only give you the capacity on each approach at a time – you will need to sum all approaches to obtain the capacity of the whole roundabout.
- If lane queues at the roundabout are long and trucks/buses block access to approach lanes, then a further reduction in capacity would need to be estimated.

Figure E.2 Illustration of an approximation of the impact of trucks on C-roundabout approach capacity when there is no significant queuing

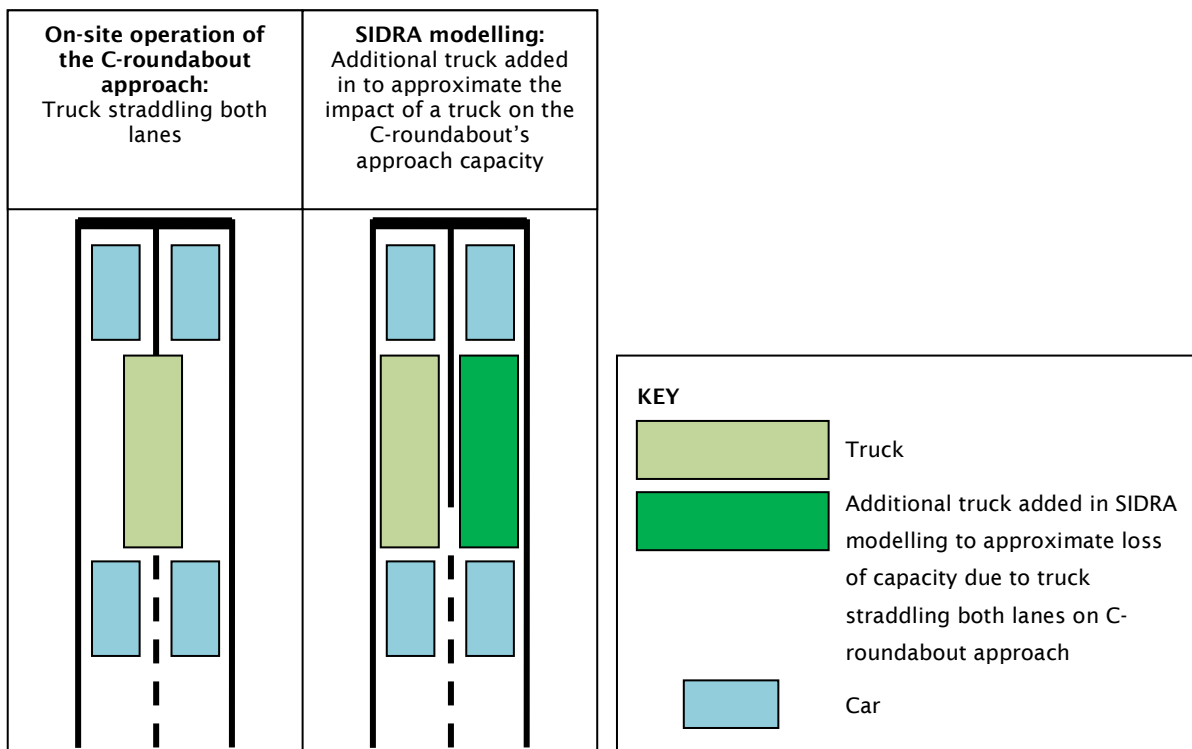
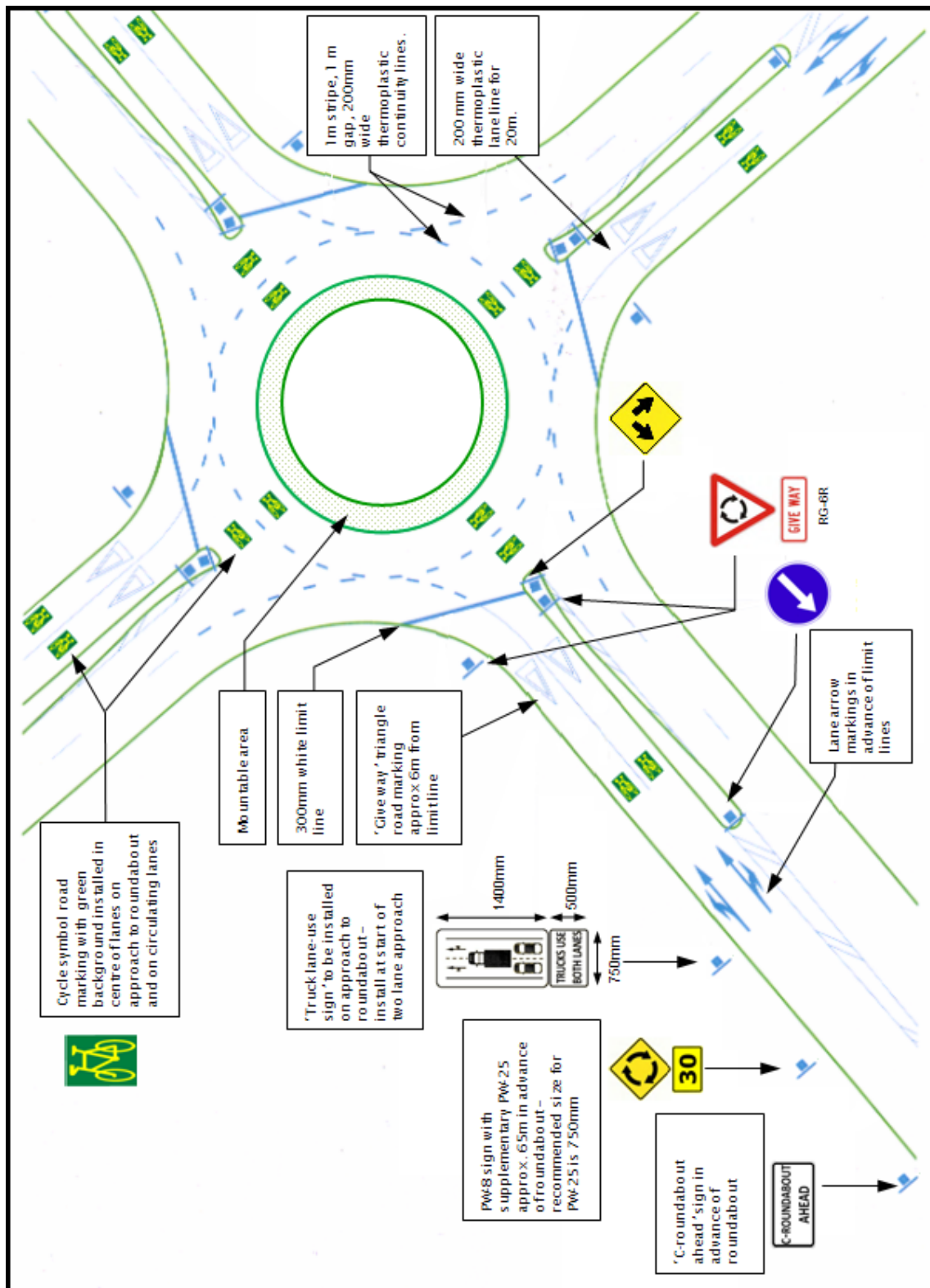


Figure E.4 C-roundabout road marking and signs



Notes:

- (a) All kerbs within 30m of the roundabout are to be painted reflective white.
- (b) ADS and prominent IDS are recommended on all approaches.
- (c) RRPMS should be used for improved night-time and wet-weather operation.
- (d) All road marking should be done in thermoplastic to ensure adequate visibility at night-time and during wet weather.

Figure E.5 Tracking curve: B-train - right turn (not to scale)

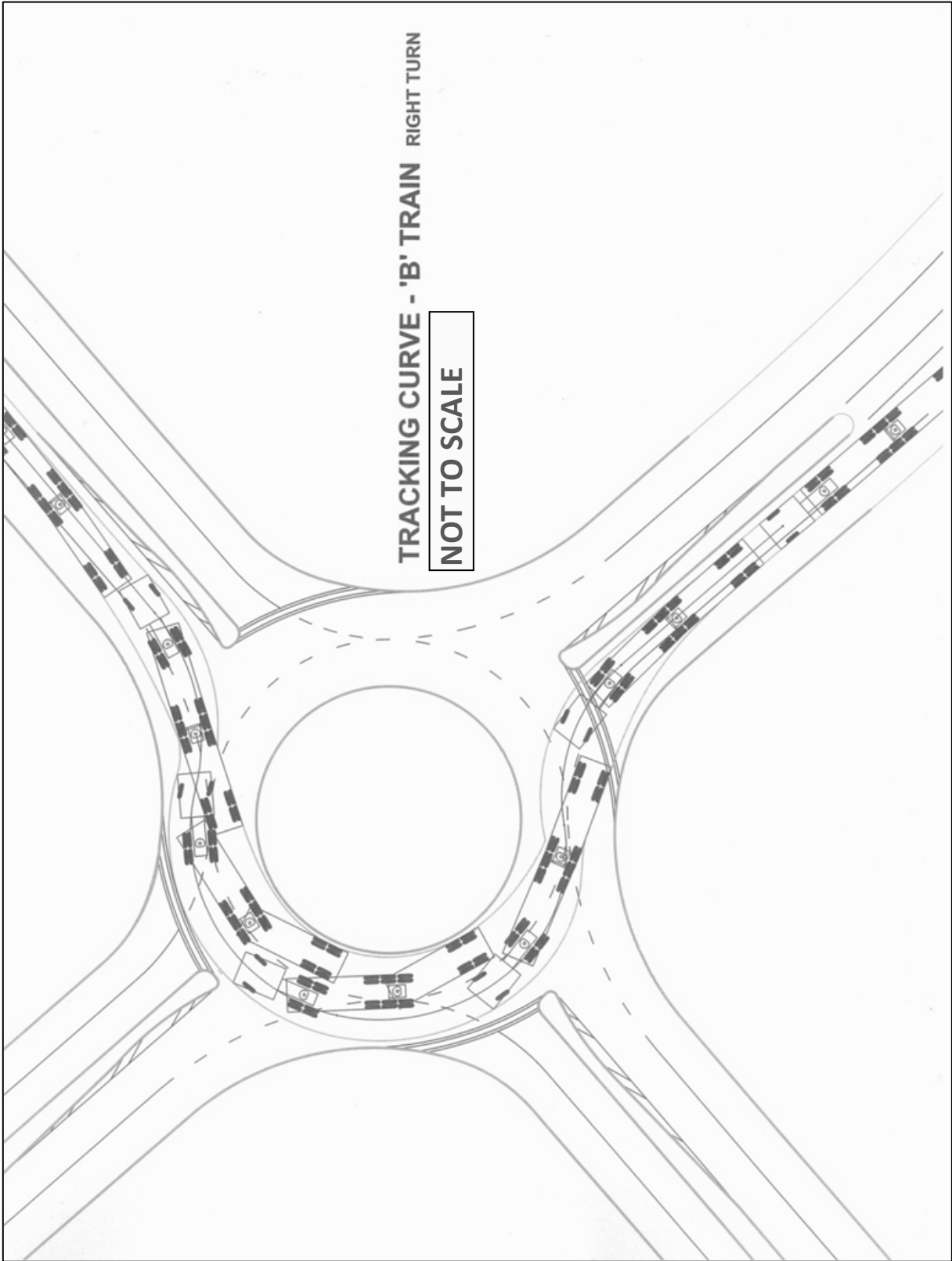


Figure E.6 Tracking curve: B-train – straight through (not to scale)

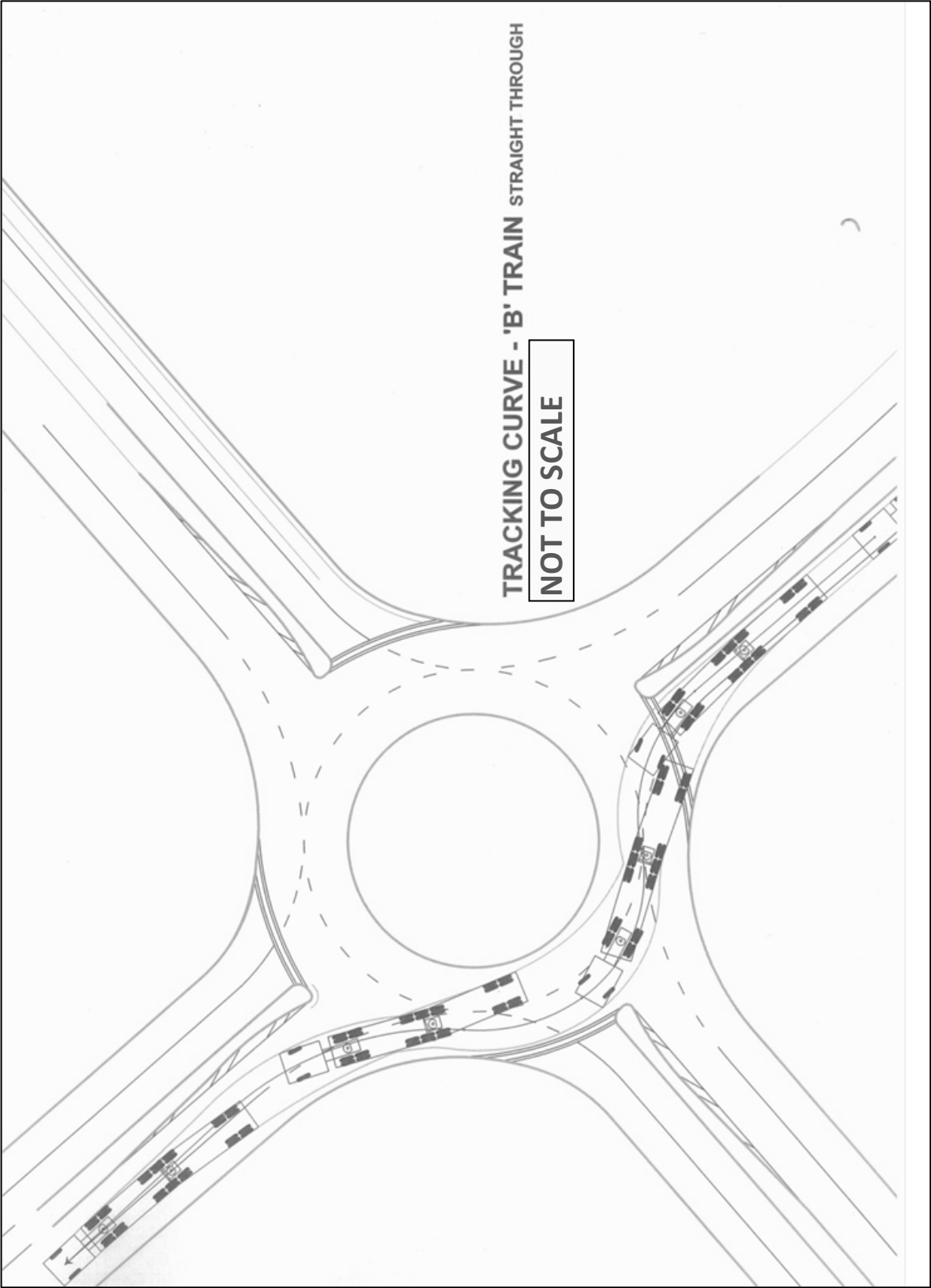


Figure E.7 Tracking curve: B-train - left turn (not to scale)

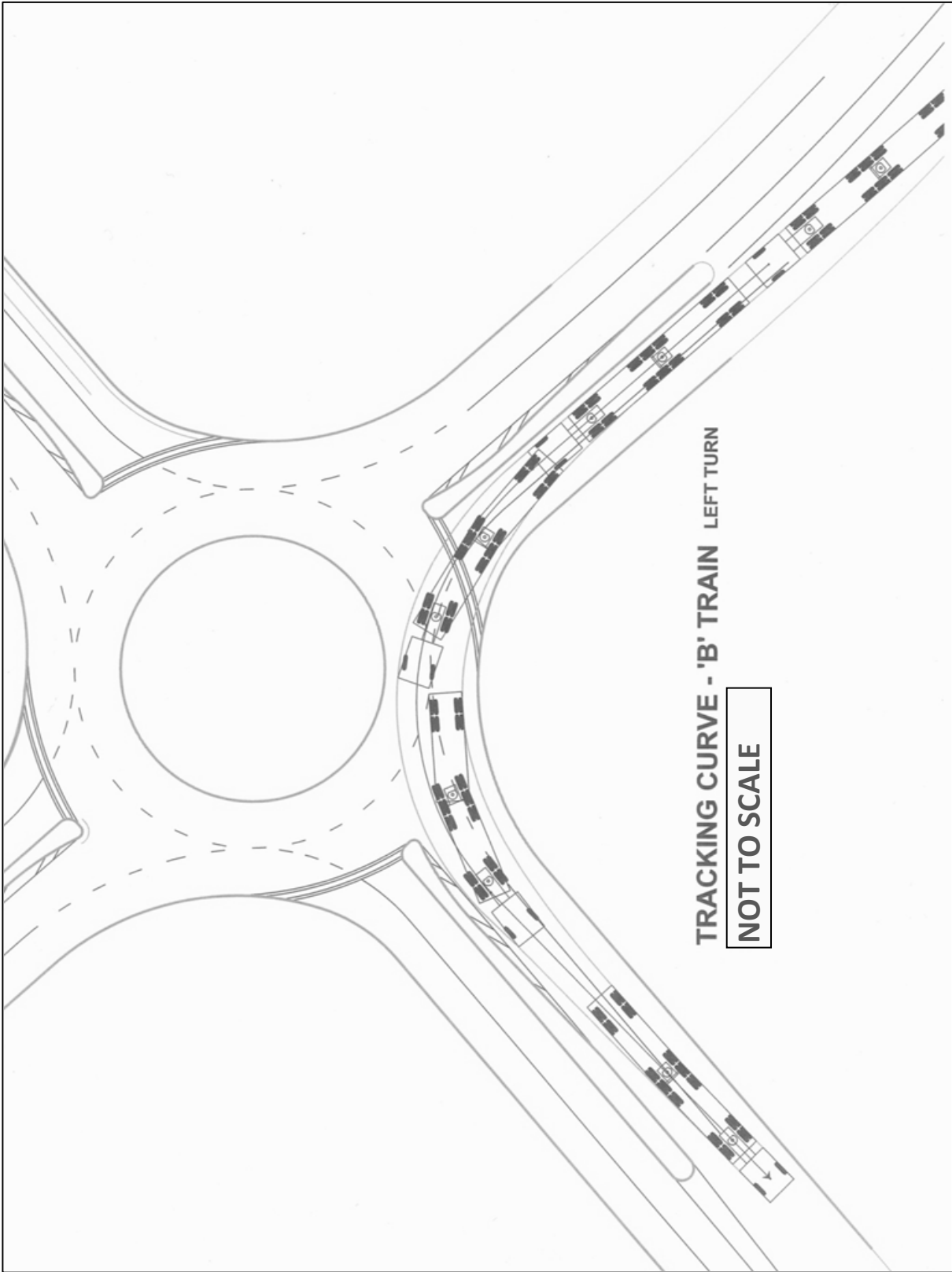


Figure E.8 Tracking curve: tour coach – straight through (not to scale)

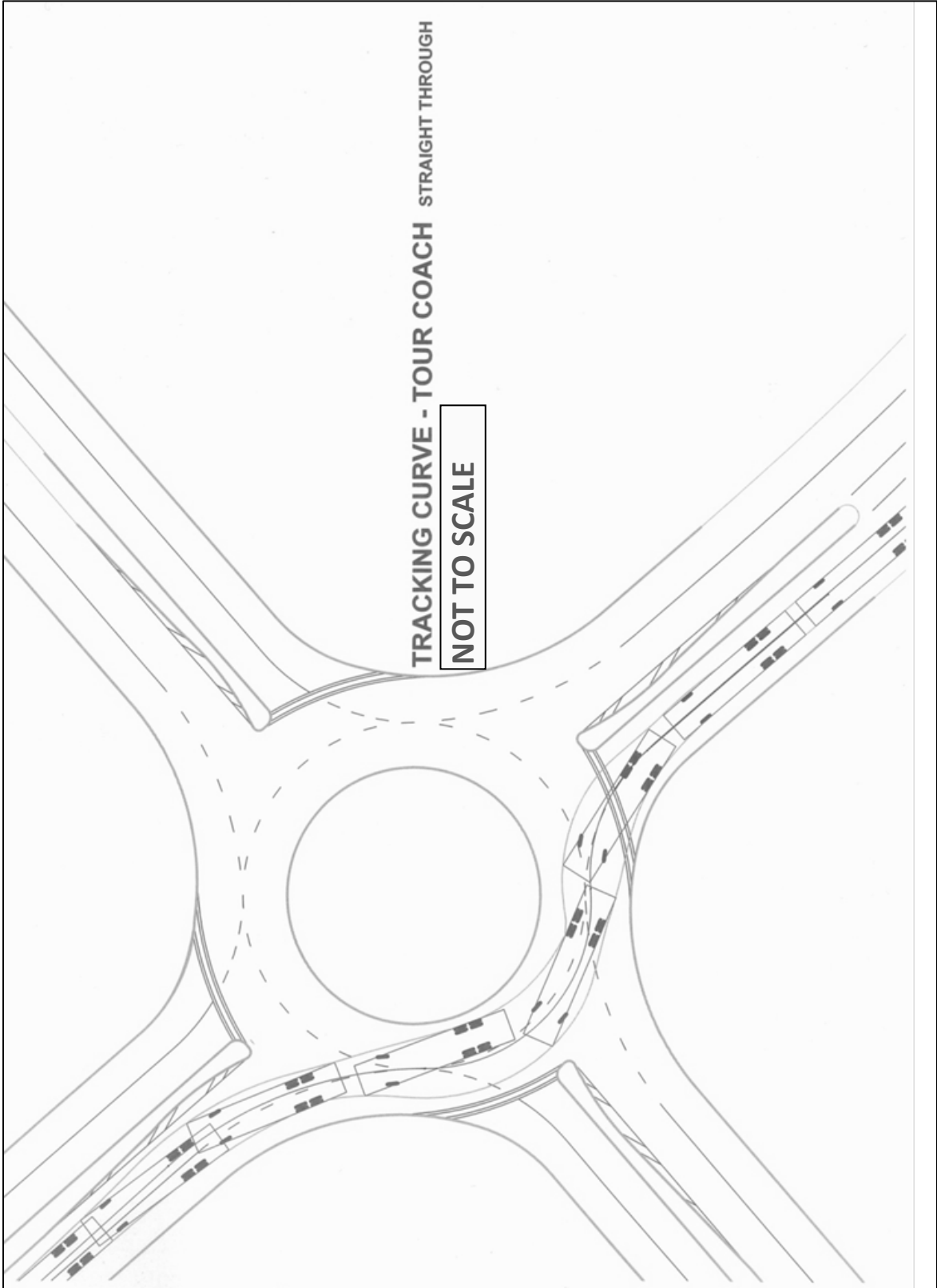


Figure E.9 Tracking curve: tour coach - right turn (not to scale)

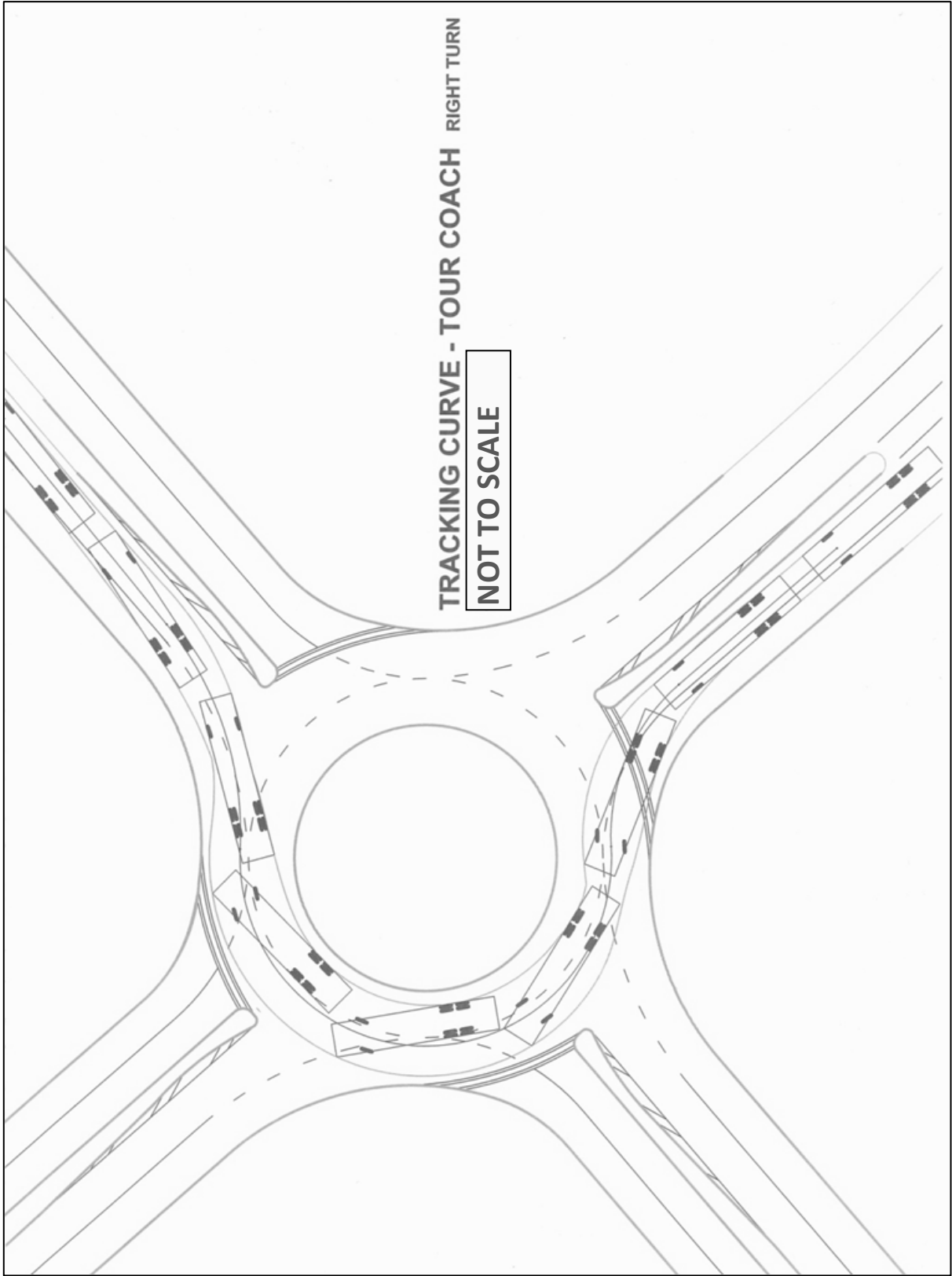


Figure E.10 Tracking curve: tour coach – left turn (not to scale)

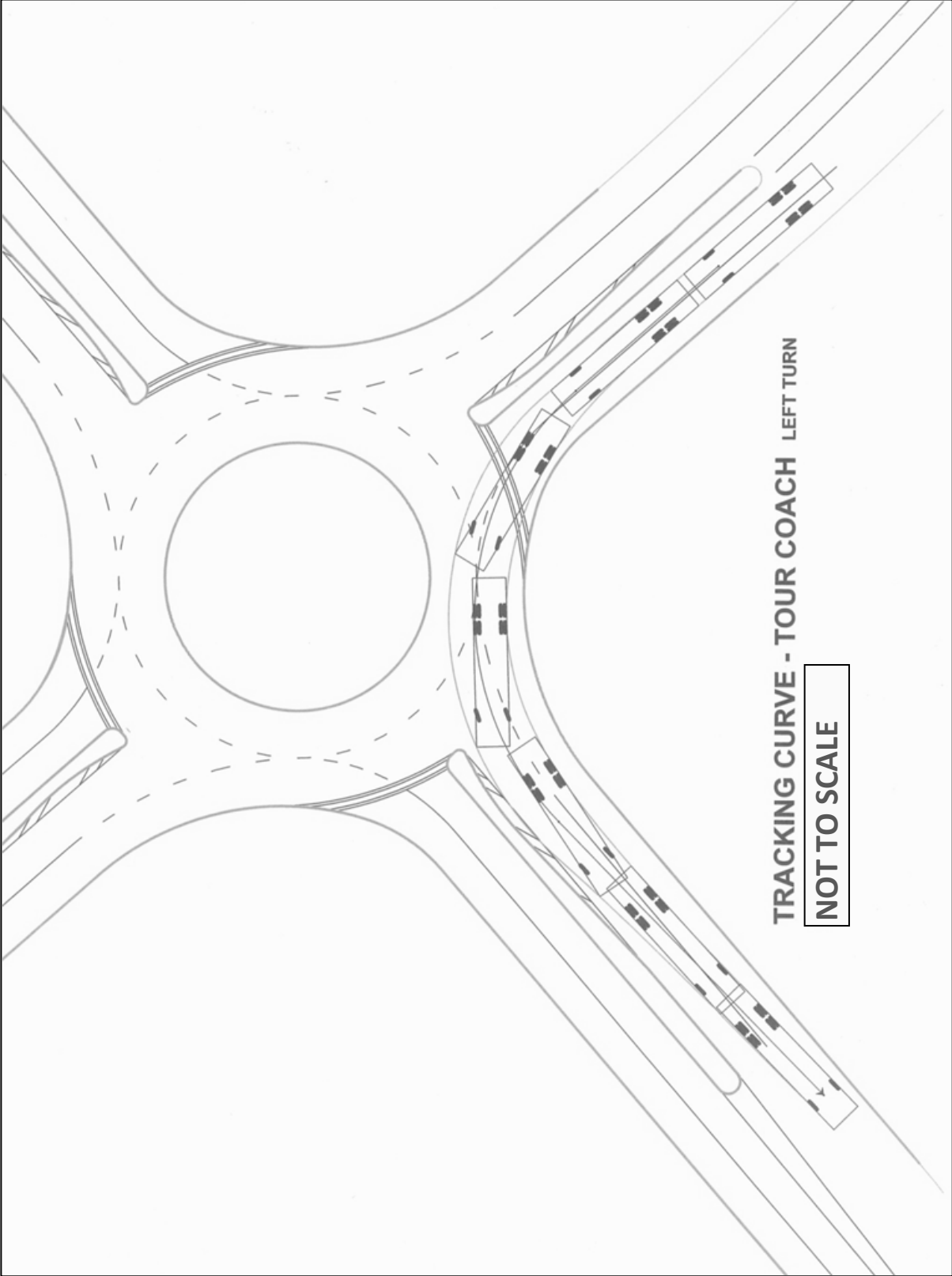
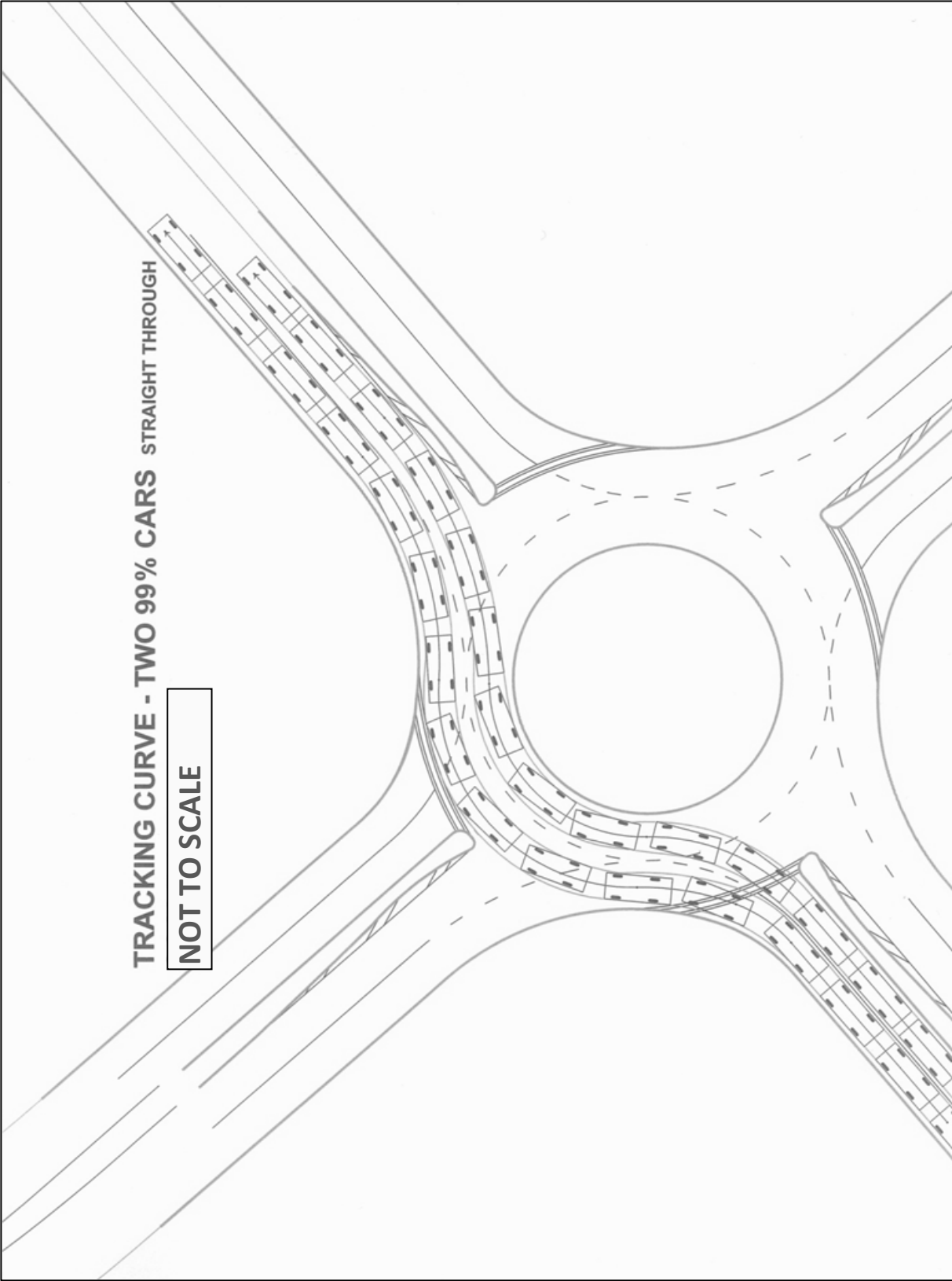


Figure E.11 Tracking curve: two 99% cars - straight through (not to scale)



Appendix F Appendix references

Austrroads (1993) *Guide to traffic engineering practice, part 6 – roundabouts*. Sydney: Austrroads Incorporated. 86pp.

Austrroads (1999) *Guide to traffic engineering practice, part 14 – bicycles*. Sydney: Austrroads Incorporated.

Austrroads (2009) *Guide to road design part 4b – roundabouts*. Sydney: Austrroads Incorporated.

Campbell, D, I Jurisich and R Dunn (2006) Improved multi-lane roundabout designs for cyclists. *NZ Transport Agency research report 287*. 140pp.

Institute of Transportation Engineers (2000) *Manual of transportation engineering studies*. HD Robertson (Ed), JE Hummer (Asst Ed), DC Nelson (Asst Ed). Washington, DC: Institute of Transportation Engineers. 514pp.

New Zealand Transport Agency (2010) *Manual of traffic signs and markings*. Wellington: NZ Transport Agency.

Standards Australia/Standards New Zealand (2005) *Lighting for roads and public spaces. AS/NZS 1158.1.1: 2005*. Sydney, Wellington: Standards Australia/Standards New Zealand.