

# **Best practice for use and design of truck mounted attenuators (TMA) for New Zealand roads**

John H Smith, Fulton Hogan

Ray Edwards, Higgins Group

Sean O'Neill, Works Infrastructure

Marcin Goluchowski, University of Auckland

ISBN 0-478-28713-5

ISSN 1177-0600

© 2006, Land Transport New Zealand  
PO Box 2840, Waterloo Quay, Wellington, New Zealand  
Telephone 64-4 931-8700; Facsimile 64-4 9313-8701  
Email: [research@landtransport.govt.nz](mailto:research@landtransport.govt.nz)  
Website: [www.landtransport.govt.nz](http://www.landtransport.govt.nz)

Smith, J.<sup>1</sup>, Edwards, R.<sup>2</sup>, O'Neill, S.<sup>3</sup>, Goluchowski, M.<sup>4</sup> 2006. Best practice for use and design of truck mounted attenuators (TMA) for New Zealand roads. *Land Transport New Zealand Research Report 301*. 100 pp.

<sup>1</sup> Fulton Hogan, J.H. Smith, PO Box 39 185, Christchurch. [john.smith@fh.co.nz](mailto:john.smith@fh.co.nz)

<sup>2</sup> Higgins Group, R. Edwards, Private Bag 11 411, Palmerston North.  
[r.edwards@higgins.co.nz](mailto:r.edwards@higgins.co.nz)

<sup>3</sup> Works Infrastructure, S. O'Neill, Private Bag 76 909 SAMC, Auckland.  
[sean.oneill@works.co.nz](mailto:sean.oneill@works.co.nz)

<sup>4</sup> University of Auckland, now Works Infrastructure, Private Bag 76 909 SAMC, Auckland. [marcin.goluchowski@works.co.nz](mailto:marcin.goluchowski@works.co.nz)

**Keywords:** Truck Mounted Attenuator (TMA), road safety, traffic management, traffic control, traffic systems, CoPTTM, roadwork, advance warning, visual enhancement system, recognition distance, retroreflectivity, strobe, beacon, perception-reaction, incident

## **An important note for the reader**

Land Transport New Zealand is a Crown entity established under the Land Transport Management Act 2003. The objective of Land Transport New Zealand is to allocate resources and to undertake its functions in a way that contributes to an integrated, safe, responsive and sustainable land transport system. Each year, Land Transport New Zealand invests a portion of its funds on research that contributes to this objective.

This report is the final stage of a project commissioned by Transfund New Zealand before 2004, and is published by Land Transport New Zealand.

While this report is believed to be correct at the time of its preparation, Land Transport New Zealand, and its employees and agents involved in its preparation and publication, cannot accept any liability for its contents or for any consequences arising from its use. People using the contents of the document, whether directly or indirectly, should apply and rely on their own skill and judgement. They should not rely on its contents in isolation from other sources of advice and information. If necessary, they should seek appropriate legal or other expert advice in relation to their own circumstances, and to the use of this report.

The material contained in this report is the output of research and should not be construed in any way as policy adopted by Land Transport New Zealand but may be used in the formulation of future policy.



# Contents

<b>Acknowledgments</b> .....	4
<b>Glossary</b> .....	9
<b>Executive summary</b> .....	13
<b>Abstract</b> .....	17
<b>1. Introduction</b> .....	19
1.1 Background.....	19
1.2 Research objectives.....	20
<b>2. Justification for the research</b> .....	21
2.1 Crash history.....	21
2.2 Near hits survey .....	23
2.3 Reasons for unifying traffic control devices.....	24
2.4 Summary.....	25
<b>3. Driver characteristics</b> .....	27
3.1 Introduction .....	27
3.2 Driver task-capability demand issues .....	28
3.3 Perception-Reaction Time (PRT) .....	30
3.4 Manoeuvring time .....	31
3.5 Driver vision.....	32
3.6 Visual acuity and contrast sensitivity .....	32
3.7 Psychological background to sign design .....	34
3.8 Summary.....	35
<b>4. Truck mounted attenuators</b> .....	36
4.1 Functions of TMA .....	36
4.2 Features of TMA.....	36
4.2.1 Arrow Board .....	37
4.2.2 Warning lights .....	37
4.2.3 Warning signs.....	41
4.2.4 Retroreflective tape.....	41
4.2.5 Attenuator.....	42
<b>5. Review of New Zealand TMA practice</b> .....	45
5.1 Development of TMA practice .....	45
5.2 HCH COP 1997 practice .....	46
5.3 CoPTTM 2004 practice .....	46
5.3.1 Requirements of a TMA.....	46
5.3.2 Requirements for multi-lane one-way Level 3 roads.....	49
5.3.3 Requirements for two-lane two-way Level 2 roads.....	50
5.4 Summary.....	51
<b>6. Review of international TMA practice</b> .....	52
6.1 United States .....	52
6.2 United Kingdom .....	55
6.3 Sweden .....	58
6.4 Germany.....	60
6.5 Summary.....	63

**Contents:** *continued*

<b>7. Methodology for TMA studies</b> .....	64
7.1 Introduction .....	64
7.2 Study 1: Trial of existing TMA set-ups .....	64
7.2.1 Overview .....	64
7.2.2 Location 1, Otahuhu–East Tamaki Southern Motorway .....	64
7.2.3 Trial of existing TMA at Location 1 .....	64
7.3 Study 2: Trial of existing and improved TMA set-ups .....	64
7.3.1 Overview .....	64
7.3.2 Location 2, Takanini, Southern Motorway .....	64
7.3.3 Trial of TMA at Location 2 .....	64
7.4 Data collection and analysis .....	64
7.5 Problems encountered .....	64
7.5.1 Study 1 problems .....	64
7.5.2 Study 2 problems .....	64
<b>8. Analysis of results</b> .....	64
8.1 Introduction .....	64
8.2 Study 1: Trial of existing TMA set-ups .....	64
8.2.1 Day conditions .....	64
8.2.2 Night conditions .....	64
8.3 Study 2: Trial of existing and improved TMA set-ups .....	64
8.3.1 Day conditions .....	64
8.3.2 Night conditions .....	64
8.4 Limitations of the study .....	64
<b>9. Conclusions</b> .....	64
<b>10. Recommendations</b> .....	64
<b>11. Future research</b> .....	64
<b>12. References</b> .....	64

## List of tables

2.1	Crash injuries occurring at worksites at which ATM were used. ....	21
2.2	Relationship of crashes with ATM to day and night operations. ....	22
2.3	Relationship of crashes with ATM to ATM type and lane closure type. ....	22
2.4	Relationship of crashes with ATM to location and traffic density level. ....	23
2.5	General causes of crashes into ATM. ....	23
4.1	Advance warning horizontal arrow display specifications. ....	38
4.2	Advance Warning horizontal arrow size specifications. ....	38
4.3	Advance warning skewed arrow display specifications. ....	39
4.4	Comparison sheet for different attenuator models. ....	43
5.1	Summary of ATM vehicle type and requirements for a mobile closure. ....	51
6.1	Recommendations for the assignment of Shadow Vehicles. ....	54
6.2	Recommendations for the application of TMA. ....	54
7.1	The eight TMA trialled for Study 1 at Location 1. ....	68
7.2	The six TMA trialled for Study 2 at Location 2. ....	74
8.1	Summary of ranking of performance (green = best; yellow = average; red = poor) of the VES of existing TMA under day conditions for Study 1. ....	78
8.2	Summary of ranking of performance (green = best; yellow = average; red = poor) of VES of modified and existing TMA under night conditions for Study 1. ....	81
8.3	Summary of ranking of performance (green = best; yellow = average) of VES of modified and existing TMA under day conditions for Study 2. ....	85
8.4	Summary of ranking of performance (green = best; yellow = average; red = poor) of VES of modified and existing TMA under night conditions for Study 2. ....	88

## List of figures

3.1	Interaction of the five traffic stream components. ....	27
3.2	Contributing factors to task demands of the driver. ....	28
3.3	Determinants of driver capability. ....	29
3.4	Representation of dynamic relationship between task demand and capability over time, showing an acute episode where demand of task exceeds driver capability. ....	29
3.5	The photometric relationship between reflectance, luminance, illuminance and intensity. ....	34
4.1	Identifying maintenance vehicles using retroreflective tape. ....	42
4.2	Safe-Stop 180 kph Crash Cushion impact. ....	44
5.1	Some improvements made to the visual appearance of TMA. ....	46
5.2	Mobile closure for multi-lane divided or multi-lane one-way Level 3 road. Work vehicle is on the carriageway. ....	47
5.3	Mobile closure for multi-lane one-way Level 3 road. Work vehicle is on the carriageway. ....	49
5.4	Mobile closure for two-lane two-way Level 2 road. Personnel are working in the live lane. ...	50

**List of Figures: *continued***

6.1	Typical TMA used in the US. ....	52
6.2	Mobile closure on a multi-lane one-way road as used in the US. ....	53
6.3	Mobile closure on a two-lane two-way road as used in the US. ....	53
6.4	Technical drawing of message board. ....	56
6.5	Standard TMA used in the UK, the arrow board of which can be changed (from the driver's cabin) to show different directions. ....	56
6.6	TMA with Skew Arrow Board, used in the UK for risky operations at night or in heavy traffic. ....	57
6.7	Layout for left-lane closure, dual two-lane, all purpose road, with hard shoulder. Personnel are working on foot. ....	58
6.8	Layout for left-lane closure, dual two-lane, all purpose road, without hard shoulder. ....	58
6.9	Shadow TMA used in Sweden. ....	59
6.10	Tail Pilot TMA used in Sweden. ....	59
6.11	The TMA set-up of a Swedish mobile operation. ....	60
6.12	TMA used for motorways in Germany. ....	61
6.13	TMA used for local roads in Germany. ....	61
6.14	Layout for right lane closure on a German motorway if visibility is between less than 800 m but more than 400 m, as for Scenario 2. ....	62
6.15	Advance warning with skewed arrow panel used on a German road if visibility is less than 2400 m, as for Scenario 3. ....	62
7.1	Location 1 of Study 1. ....	65
7.2	Northbound lanes on Location 1 on the Southern Motorway, Auckland. ....	66
7.3	Layout of TMA at Location 1 for Study 1, on the Southern Motorway. ....	67
7.4	Location 1 showing the shoulder closure on the motorway which necessitated a change of trial site to Location 2 for Study 2. ....	70
7.5	Location 2 of Study 2. ....	71
7.6	Southbound lanes at Location 2 on Southern Motorway, Auckland. ....	71
7.7	Layout of TMA at Location 2 for Study 2, on the Southern Motorway. ....	72
8.1	(a) Graphs and (b) cumulative curves for the relationships of VES on Trucks 6 (best), 1 (average), and 2 (poorest), for their different performances under day conditions. ....	79
8.2	(a) Graphs and (b) cumulative curves for the relationships of VES on Trucks 1 (best), 5 (average), and 8 (poorest), for their different performances under night conditions. ....	82
8.3	(a) Graphs and (b) cumulative curves for Trucks 10 (average) and 11 (best), under day conditions. ....	86
8.4	A new type TMA on Truck 10 in the Study 2 trial. ....	87
8.5	(a) Graphs and (b) cumulative curves for Trucks 1 (poorest), 9 and 10 (average), and 11 (best) under night conditions. ....	89



## Glossary

Terms related to and used in this research are listed.

**AADT:** Annual Average Daily Traffic

**Accident:** see **Crash**, preferred term for physical damage caused to person or vehicle

**ANOVA:** Analysis of Variance

**Arrow Board:** a safety device with directional arrows depicted in flashing yellow lights

**Attenuator** or **Crash Cushion:** a safety appliance mounted on the rear of a vehicle that dissipates the energy of a rear-end collision caused by a following vehicle, by collapsing when impacted by that vehicle

**Braking Distance (BD):** distance travelled during braking (Transit CoPTTM 2004)

**Closure:** the physical area between the 'Advance Warning' sign and the 'End of Works' sign including all devices required to divert traffic, from which the traffic is to be excluded (Transit CoPTTM 2004)

**CoPTTM:** Code of Practice for Temporary Traffic Management (Transit 2004)

**Crash:** impact in which physical damage is caused to person or vehicle

**Crash Cushion:** a safety device or attenuator fitted to the rear of a vehicle that collapses when impacted by another vehicle (Transit CoPTTM 2004)

**Critical Zone:** distance of road that is shorter than the safe stopping sight distance

**Hazard:** any activity and/or condition that changes the normal operating conditions of a road, and is an actual or potential cause or source of harm to road users and/or road workers (Transit CoPTTM 2004)

**High Capacity Highway:** state highway or regional road with >10,000 vpd

**Incident:** impact in which physical damage is not necessarily caused to persons or vehicles

**Inter-visibility:** driver's vision, from the driver's seat, of the road environment

**Level 1 Road:** Low traffic volume road: less than (<) 10 000 vehicles per day

**Level 2 Road:** High volume road: more than (>) 10 000 vehicles per day

**Level 3 Road:** High volume road: more than (>) 10 000 vehicles per day and high speed multilane roads and motorways

**Live Lane:** a lane that is used by vehicles (Transit CoPTTM 2004)

**Long-term Operation:** an activity on a **Level 2** or **Level 3** road that occupies a work site for more than one day; no differentiation is made between a short-term and long-term activity on a **Level 1** road (Transit CoPTTM 2004)

**LTNZ:** Land Transport New Zealand (or any successor organisation)

**Message Board:** a panel which usually consists of the following safety devices: **Arrow Board**, Warning lights, Warning signs, and Retroreflective tape

**Mobile Operation:** operation or activity not contained within a fixed site, and where vehicles are progressively travelling in the same direction as, but at a speed less than, or in a manner different from, normal traffic; mobile operations may involve planned stops of up to ten minutes (Transit CoPTTM 2004)

**Motorway:** a length of legal road designated as a 'Motorway' in terms of the Transit New Zealand Act; generally such roads are identified with 'Motorway Starts' and 'Motorway Ends' signs (Transit CoPTTM 2004)

**Peak:** term associated with traffic flows: the times of the day or night, month or year, when the road carries higher traffic flows, in either one or both directions (Transit CoPTTM 2004)

**Retroreflectivity:** the specific property of a material which reflects illuminating light from a source, usually vehicle headlights, back towards the source (Transit CoPTTM 2004)

**Road User:** any user of the road, including motor vehicle drivers, motorcyclists, pedestrians and cyclists (Transit CoPTTM 2004)

**Roll Ahead Distance:** the distance to allow for forward movement of a vehicle following a rear impact from another vehicle (Transit CoPTTM 2004)

**Recognition Distance (RD):** the distance at which the object (e.g. TMA) can be seen, correctly identified, and followed by the manoeuvre of (or indicating to be) switching lanes

**Safety Zone:** a three-dimensional space extending to the front and back, to the sides and above the working space; this space also includes the areas within the coned tapers although these are not included in the safety zone dimensions; the safety zone should be kept clear of personnel, equipment or materials (Transit CoPTTM 2004)

**Semi-Static Operation:** mobile-type activities that stop for more than ten minutes and less than one hour at one location (Transit CoPTTM 2004)

**Short-term Operation:** an operation occupying a location for less than one day on a **Level 2** or **Level 3** road. No differentiation is made between a short-term and long-term activity on a **Level 1** road (Transit CoPTTM 2004)

**Shoulder:** pavement surface outside the edgeline or an inferred line along the outside edge of a lane (Transit CoPTTM 2004)

**Stopping Sight Distance (SSD):** the minimum distance required by an average driver of a vehicle travelling at the design speed to perceive an object on the road ahead, react, and stop safely before reaching it

**Taper:** a straight or smoothly curved row of delineation devices used to shift traffic laterally, e.g. from a lane to the shoulder (Transit CoPTTM 2004)

**TMA: Truck-mounted Attenuator** or a truck equipped with **Message Board**, **Arrow Board**, and **Crash Cushion**

**Traffic Management Plan (TMP):** a document describing the design, implementation, maintenance and removal of temporary traffic management while the associated activity is being carried out within the road reserve, or adjacent to and affecting the road reserve (Transit CoPTTM 2004)

**Truck-Mounted Attenuator:** an attenuator or crash cushion mounted on the rear of a truck that dissipates the energy of a rear-end collision; its purpose is to direct traffic to an open lane in advance of a road work site to provide safe working environment for workers, but able to withstand rear-end collisions with it.

**TTM:** Temporary Traffic Management.

**Variable Message Sign (VMS):** a sign that can be changed to give different messages

**Visual Enhancement System (VES):** a system that enhances the visual impact of an object, and may include warning lights, **Arrow Board**, retroreflective tape

**Wordy Sign/Display:** a warning sign or panel that uses words for its message

**Work Site:** the section of road defined at each end by 'Advance Warning' and 'End of Works' signs, or between vehicles in a mobile operation, including the vehicles themselves (Transit CoPTTM 2004)

**Working Space:** the area around a hazard or work site that is available for workers' use to complete the activity (Transit CoPTTM 2004)











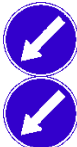

## Facsimile of signs used in mobile operations

from Code of Practice for Temporary Traffic Management, SP/M/010, 3<sup>rd</sup> edition, 2004

### B1.4 Signs Used at Work Sites

For the full sign use policies, and sign design details, refer to MOTSAM Part I: Traffic Signs, Section 2: Regulatory Signs and Section 5: Temporary Warning Signs.

#### B1.4.1 Advance Warning

<p><b>TW - 1</b> <b>ROAD WORKS</b></p>			<p>This sign is erected at all attended work sites that are not specifically covered by TW-1."_" signs. The sign is also used at unattended work sites where there are hazards within 5 m of the edge line.</p>
<p><b>TW - 26</b> <b>ROAD WORKS</b> <i>(vehicle mounted only)</i></p>			<p>This sign must be used in conjunction with vehicle mounted flashing yellow lights and must be mounted on the front of the lead pilot vehicle of all mobile operations.</p>
<p><b>RG - 17 / RG - 17.1</b> <b>KEEP LEFT</b> <i>SINGLE DISK / TWIN DISK</i></p>	 <p><i>(Normal minimum diameter is 750 mm but 600 mm diameter signs may be used when they are vehicle mounted)</i></p>	 <p><i>(300 mm diam.)</i></p>	<p>RG-17 and RG-17.1 signs are used to indicate that drivers must pass to the left of an obstruction or that the traffic lane(s) shift to the left.</p>
<p><b>RG - 34</b> <b>KEEP RIGHT</b></p>	 <p><i>(Normal minimum diam. 750 mm, 600 mm diam. when vehicle mounted)</i></p>		<p>RG-34 signs are used to indicate that drivers must pass to the right of an obstruction or that the traffic lane shifts the right.</p>
<p><b>TW - 18</b> <b>PLEASE STOP ON REQUEST</b></p>			<p>This sign is used in advance of the TW-2.12 TRAFFIC SURVEY sign and also as a supplementary plate to the TW-15 MANUAL TRAFFIC CONTROL sign to form the TW-15.1 sign combination.</p>
<p><b>TW - 20</b> <b>ROAD/EXIT CLOSED AHEAD</b></p>			<p>This sign is used where the road, or motorway/expressway exit ahead is closed. In normal circumstances an alternative route or detour will also be provided.</p>
<p><b>TW - 34 (L/R)</b> <b>PASS WITH CARE</b> <i>(vehicle mounted only)</i></p>	 <p><i>(RG - 34L sign 600 mm diam.)</i></p>	 <p><i>(RG - 34R sign 600 mm diam.)</i></p>	<p>PW-34 signs may be substituted for the relevant TW sign required to be mounted on the rear of shadow and work vehicles involved in temporary mobile operations. The RG-17 or RG-34 sign may be omitted when the vehicle is fitted with an arrow board.</p>

## **Executive summary**

### **Introduction**

Truck Mounted Attenuators (TMA) are widely used on New Zealand Level 2 and 3 state highways and on some network roads that carry high-volume high-speed traffic, to provide safe environments for both roadwork crews and road users. They are used for static, semi-static and mobile operations carried out on sealed carriageways.

However, current practice (specified in the 3<sup>rd</sup> edition of Transit New Zealand Code of Practice for Temporary Traffic Management (CoPTTM June 2004)) has not prevented 39 TMA incidents occurring in the past five years (July 1999 to July 2004), including four fatalities, as well as numerous injuries. Rather than enhancing safety, the VES currently used on TMA have the potential to adversely affect driving, and to create unsafe circumstances by providing drivers with inefficient messages. This high incident rate involving TMA on New Zealand roads prompted the roading industry to form a Working Group<sup>1</sup> in 2004 to investigate driver perception–reaction issues of operating TMA on the road.

### **Research objectives**

The overall aims and objectives of the research project, carried out in 2004-05, were therefore as follows:

1. Compile and manage an incident database incorporating data from the last five years (1999-2004), to assess the extent of TMA incidents on New Zealand roads.
2. Benchmark present driver behaviour as they approach TMA at mobile operations, using current New Zealand practice and temporary traffic management (TTM) devices.
3. Review international 'best practice' at roadwork sites, with the intention of defining New Zealand Best Practice for TMA operations.
4. Select an appropriate TTM layout, including specifications for TTM devices; trial the proposed best practice, and compare it with current New Zealand practice.
5. Determine recommendations for improving the visual requirements for TMA units involved in static, semi-static and mobile operations, and for improving TMA operational procedures.

### **Research studies**

The research consisted of two field studies to evaluate the visual performance of existing and modified TMA, during night and day, under actual driving conditions and clear weather conditions.

---

<sup>1</sup> The Working Group comprised representatives from Fulton Hogan, Higgins Group, and Works Infrastructure. The sponsors of the study were Department of Labour Occupational Health and Safety Service (OSH), Land Transport Safety Authority (LTSA, now Land Transport New Zealand), NZ Police, and Transit New Zealand. Researchers from the University of Auckland assisted in the research.

The research also identified the most desirable improvements which can be made to VES mounted on TMA and unification of TMA practice. This will allow drivers to react in a safe manner and also provide consistency in TMA appearance. It will protect drivers from the uncertainty related to the many different systems for traffic management that are employed at present by various companies involved in this type of work.

## Conclusions

### – from studies of TMA set-ups

- *Advance warning systems gave a TMA set-up which out-performed any other set-up, during either day or night.*

Under day conditions, the set-up with an advance warning system resulted in at least 27.7% fewer drivers reacting in the last 300 m, and at least 25.4% fewer drivers reacting in the last 210 m.

Under night conditions, this set-up resulted in at least 15.4% fewer drivers reacting in the last 300 m and at least 5.8% fewer drivers reacting in the last 210 m.

- *Flashing strobe lights mounted on the truck improved drivers' reactions.*

These lights gave enhanced capabilities over rotating beacon lights, with at least 11.3% fewer drivers reacting in the last 300 m under night conditions.

- *Under day or night conditions, wide retroreflective tape around the edges of the arrow board significantly improved drivers' average Recognition Distance of the TMA by at least 38 m.*

At least 17% fewer drivers were reacting in the last 300 m for a truck with retroreflective tape compared with a truck which did not have the tape.

- *Recognition Distances increased at night when traffic volumes were lower, compared to Recognition Distances recorded during the day with higher traffic volumes.*

### – for best TMA set-ups

**Set-up 1** was achieved for both day and night conditions from the set-up with the new TMA combined with the advance warning system as a diagram, and which displayed:

- Lane drop signs
- 340 mm-diameter flashing strobe lights fitted at the top
- Words on Message Board stating

#### **LEFT LANE CLOSED**

This set-up achieved mean recognition distances:

- for day use, of 455.15 m with 1.8% vehicles in lane at 210 m; and
- for night use, of 443.09 m, 1.1% vehicles in closed lane at 210 m.

**Set-up 2** was achieved for both day and night conditions from the set-up with the new TMA combined with an advance warning system, and which displayed:

- Words on Message Board stating

**PLEASE MERGE 400 M – LEFT LANE CLOSED 400 M**

- 340 mm-diameter flashing strobe lights

This set-up achieved mean recognition distances:

- for day use, of 439.70 m of 2.2% at 210 m; and
- for night use, of 429.50 m of 1.0% at 210 m.

## **Recommendations**

### ***– for positioning traffic management equipment***

- Advance warning systems that are simply and clearly understood should be used immediately.
- Positioning the advance warning system on the road shoulder at a minimum distance of 400 m before the Shadow TMA, is required for mobile operations.
- The message should be displayed in diagram form or as a sign with large descriptive text.
- As the message requires special attention from the driver, the advance warning system should have two 340-mm flashing strobe lights mounted on the top of it, to inform the driver of the lane closure ahead.
- If drivers have been appropriately informed, they will have enough distance to respond safely, and then a Tail TMA need not be used for left-lane closures.

### ***– for increasing the visibility of TMA truck units***

#### ***by flashing strobe lights***

- Flashing strobe lights of 340-mm diameter provide better information, out-perform the rotating beacons, and result in quicker responses from drivers. The lights should be mounted as high as practical above the arrow board and advance warning system so they do not conflict with the visual performance of these signs.
- The rate of flashing should operate when the arrow board lights are not on, so that drivers see an alternating pattern of the arrow board message and the flashing strobe lights. Flashing should be at alternating frequencies.
- Lights must be positioned far enough apart from the arrow board or the two operations will conflict, visual sensitivity to the arrow board will be reduced, and the message will not be clear to the driver.

#### ***by retroreflective tape***

- The arrow board must be fitted with wide retroreflective tape around the edges of the board. Attaching these strips enhances the shape and size of the TMA to make them appear brighter and easier to see at night.
- Retroreflective tape, usually associated with the roadwork sites, promotes safe driving and makes a TMA more recognisable from the rest of the traffic.

***by use of supplementary warning signs***

- A large RG17/34 sign with up-lighting that operates to the left or the right, in coordination with the illuminated arrow board, can improve drivers' recognition of the required lane shift ahead.
- Inclusion of a European-type arrow board and associated directional change arrow signs fitted to the rear and strobe lights fitted at the top of the TMA out-performed the typical standard TMA (with rotating lights).

However, European-type TMA performed no better than the existing TMA which have been modified with strobe lights, and are used already in New Zealand.

***– for timing of operations***

- Mobile operations for roadworks are best undertaken during off-peak hours when the lower traffic volumes increase drivers' Recognition Distances. Drivers then have increased inter-visibility, compared with conditions under the higher traffic volumes during peak hours.
- During off-peak hours, the merging manoeuvre to the open lane is easier to complete, vehicles do not have to queue behind the TMA, and the traffic stream should flow smoothly.



## **Abstract**

The crash incident rate involving Truck Mounted Attenuators (TMA) on New Zealand roads has prompted an industry-wide investigation into driver perception of and reaction to the visual and operational aspects of TMA operating at roadwork sites. As an indication of the size and the extent of the problem, the major contractors reported 39 TMA incidents in a 5-year period (1999-2004), including four fatalities. To date there has been no research into the use of TMA in the New Zealand roading environment.

The research, begun in 2004, consists of two main studies. Both studies are carried out in actual driving conditions, under clear weather, day and night. Evaluation of TMA effectiveness is by 'recognition distance' and percentage of vehicles entering the 'critical' zone (defined as anything shorter than the safe stopping sight distance when different Visual Enhancement Systems (VES) are used). Study 1 evaluates current TMA practice on New Zealand roads and serves as the baseline for Study 2. Study 2 incorporates the most effective TMA practices from Study 1 as well as those employed overseas.

VES currently used on TMA have the potential to adversely affect driving and create unsafe situations by providing drivers with inefficient messages. This research shows the most desirable improvements to the TMA operations which should decrease the number of incident and fatality rates currently occurring on New Zealand roads. Positioning advance warning system 400 metres before TMA outperformed any other practice resulting in 27.7% fewer cars reacting in the last 300 metres. Flashing strobe lights demonstrated enhancement capabilities over rotating beacon lights at night. Retroreflective tape on the edges of the message board improved the average recognition distance of the TMA by at least 38 metres at night.

Further research is suggested to incorporate the investigation into the message board size and flashing warning light frequency which may have a positive effect on the traffic flow. In addition, message board and retroreflective tape colour needs unification to make TMA more recognisable from the rest of the traffic and therefore promote safe driving while operating on the road.



## 1. Introduction

### 1.1 Background

Truck-mounted Attenuators (TMA<sup>2, 3</sup>) are widely used on New Zealand state highways and some network roads that carry high-volume high-speed traffic, to provide safe environments for both roadwork crews and road users.

However, current practice, as specified in the 3<sup>rd</sup> edition of the Code of Practice for Temporary Traffic Management (Transit CoPTTM 2004), has not prevented the 39 TMA incidents reported in the past five years. In two such incidents four fatalities occurred. Because of this high incident rate involving TMA on New Zealand roads, and that the Visual Enhancement Systems (VES) currently used on TMA have the potential to adversely affect driving, creating unsafe circumstances by providing drivers with inefficient messages, prompted the roading industry to form a Working Group<sup>4</sup> in 2004 to investigate the reasons.

Attention has been drawn by the roading industry and several national agencies (and outlined in the Project Proposal presented in 2004) to driver perception–reaction issues affected by the diversity of appearances (or visual outlook) of TMA between and within industry companies.

Unification of TMA practice will allow drivers to react in a safe manner and also will provide consistency in appearance of TMA. It will protect drivers from the uncertainty related to the many different systems for traffic management that are employed at present by various companies involved in this type of work. Also no research had so far been carried out in New Zealand.

The research was begun in 2004 to evaluate and identify the visual performance of existing and modified TMA and their operation during night- and day-time in actual driving conditions, and under clear weather conditions. Monitoring and evaluating TMA was by recognition distance (RD) and by the percentage of vehicles entering the critical zone. The critical zone is defined as anything shorter than the safe stopping sight distance (SSSD) when different VES are used. The outcomes were compared to assess the effectiveness of the VES modifications to determine a unified recommendation that could be included in future revisions of the Transit CoPTTM.

Some related national and international studies offered sound advice for the unification of visual and operational aspects of the design of traffic control devices used in roading

---

<sup>2</sup> See Glossary for definitions of special terms.

<sup>3</sup> For description of a TMA and its components see Chapter 4.

<sup>4</sup> The Working Group was made up of representatives from Fulton Hogan, Higgins Group, and Works Infrastructure. The sponsors of the study were Department of Labour Occupational Health and Safety Service (OSH), Land Transport Safety Authority (LTSA, now Land Transport New Zealand), NZ Police, and Transit New Zealand. Researchers from the University of Auckland assisted in the research.

(Transit 2004; FHWA 2003; UK Highways Agency 2003). The rationale on which traffic control design is based is that the driver's reaction is mostly dependent on visual input and on their recollection from previous driving education or experience (Fuller & Santos 2002; Sanderson 1972).

Roadwork zones, and especially short-term lane closures where no advance warning is set up, can represent a particular hazard to road users. For this reason, the importance of providing adequate warning, clear and unambiguous traffic control through the roadwork zone, and of leaving the roadwork zone in a safe condition when unattended has been stressed as a vital practice (Ogden & Bennett 1996). Unification of TMA practice will allow drivers to react in a safe manner and will reduce their confusion caused by the many different systems of traffic control that have been implemented by different roading companies.

## **1.2 Research objectives**

The purpose of this research is to investigate modelling the relationship between the recognition distance of the traffic flow, and different configurations of VES mounted on TMA, during day and night operations under clear weather conditions. Since better understanding of the factors that increase risk perception, and of which systems improve recognition distances, would lead to the improvement of safety at the short-term operations.

Consequently, the overall aims and objectives of the research project were to:

1. Compile and manage an incident database incorporating data from the last five years (1999-2004), to assess the extent of TMA incidents occurring on New Zealand roads.
2. Benchmark present driver behaviour as they approach TMA at mobile operations, using current New Zealand practice and Temporary Traffic Management (TTM) devices.
3. Review international 'best practice' at roadwork sites, with the intention of defining New Zealand Best Practice for TMA operations.
4. Based on international best practice, select an appropriate TTM layout, including specifications for TTM devices. Trial the proposed best practice, and compare it with current New Zealand practice (as defined in Transit NZ CoPTTM 2004).
5. Determine recommendations for improving the visual requirements for TMA units involved in static, semi-static and mobile operations, and for improving TMA operational procedures. The recommendations are to be submitted to Transit NZ CoPTTM Industry Review Group to consider for inclusion as best practice in future revisions of CoPTTM.

## 2. Justification for the research

Based on the discussion presented in Chapter 1, the crash rate indicates a need to research why TMA are being hit. Attention must be also drawn to the development of a sole and unified TMA best practice related to both visual and operational issues of TMA. The TMA practice specified in earlier versions of the Transit CoPTTM (2000; 2003; 2004), has not changed significantly in the past few years. In fact the present set-ups of TMA have resulted in 39 TMA incidents reported in the past five years, two of which resulted in four fatalities. The changes implemented in the CoPTTMs over the last five years has not focused on the visual requirements of the TMA, but neither has the present recommendation on the use of advance warning always been followed by the industry.

### 2.1 Crash history

A summary was compiled of the 39 investigated reported crashes that involved actual hits which had occurred in the 5-year period from 16<sup>th</sup> July 1999 to 15<sup>th</sup> July 2004. Despite TMA being equipped with mounted Attenuators (the high standard safety devices that play a major role in saving road users' lives and also protect roadwork crews from errant vehicles), Table 2.1 shows that four fatalities occurred in two crashes, and at least three serious injuries were reported in other cases. In one fatal accident an elderly couple did not survive the crash impact. To some extent this also supports the public health perspective that the probability of older drivers being seriously injured or killed in a crash is greater than for other age-group traffic users (Helmer 2004).

The second fatal crash case was related to an inexperienced driver and not using safety belts. Safety belts reduce the chance of death or serious injury in a crash by 40% but only approximately 8%–19% of drivers or passengers in New Zealand still do not wear safety belts (LTNZ 2005). Most motorists managed to escape injury in TMA-related accidents because attenuators evenly and gradually dissipate the kinetic energy of an impacting vehicle. They thereby prevent it from riding under the truck body which can result in shearing the top off the impacting vehicle at the bonnet line.

However, some serious and fatal crashes have happened, which has drawn attention to the issue through industry companies and prompted them to take appropriate action.

**Table 2.1** Crash injuries occurring at worksites at which ATM were used.

Type of injuries	Number of incidents/crashes	Number of people involved
Fatal	2	3
Serious	3	3
Minor	1	1
Nil	13	19+
Unreported	20	20+
<b>Total</b>	<b>39</b>	<b>49+</b>

Even though most of the worksite operations are undertaken under night conditions, Table 2.2 indicates that most of the crashes occur under day conditions when the traffic flow is heavier.

**Table 2.2 Relationship of crashes with ATM to day and night operations.**

Day/Night	Number of crashes (%)
Day	18 (46)
Night	12 (31)
Unreported	9 (23)
<b>Total</b>	<b>39 (100%)</b>

Usually two TMA are involved in a worksite operation. The first one follows a short distance behind a moving or a temporary worksite and is called a 'Shadow TMA'. The second one, not always obligatory, is positioned further back on the shoulder or live lane to warn drivers that the lane is closed and it is called the 'Tail TMA'.

The main concern of roading companies using TMA relates to mobile lane closures, the type in which 24 (62%) of these crashes occurred (Table 2.3).

Mobile lane closure operations commonly carried out by the roading industry, for example the installation of the road closures themselves, or pothole and barrier repairs, are the most dangerous. In these operations, no cones or advance warnings are set up to warn drivers to change lane. Therefore if they are to operate successfully, they rely directly on drivers' perception–reaction responses to the Tail TMA.

Table 2.3 also records that the number of crashes that involved drivers hitting the Tail TMA account for 19 of the 24 crashes occurring during mobile closures. The remaining three reported crashes were caused by distracted or inattentive drivers who had passed the Tail TMA safely but hit the Shadow TMA.

**Table 2.3 Relationship of crashes with ATM to ATM type and lane closure type.**

ATM type	Type of lane closure				Sum (%)
	Mobile(%)	Semi – static (%)	Static (%)	Unreported (%)	
Tail pilot	19	2	-	-	21 (54%)
Shadow	3	2	3	-	8 (20%)
Unreported	2	-	4	4	10 (26%)
<b>Total</b>	<b>24 (62%)</b>	<b>4 (10%)</b>	<b>7 (18%)</b>	<b>4 (10%)</b>	<b>39 (100%)</b>

Nearly all crashes took place in the Auckland or Wellington regions where most TMA are used. These large urban areas of increasing population carry high traffic volumes on high speed roads, and their need for transportation improvements and road maintenance is greater than in other parts of New Zealand. Of the 39 crashes, 37 (95%) occurred on Level 3 roads (Table 2.4), which are classified as high volume roads with more than

10,000 vehicles per day and high speed multilane roads and motorways (Transit NZ 2004).

Roadwork operations on such Level 3 roads require TMA (Transit NZ 2004) where extra enforcement must be undertaken to protect both road workers and road users.

**Table 2.4 Relationship of crashes with ATM to location and traffic density level.**

Location	Road traffic level	
	Level 3	Level 2
Auckland	27	1
Tauranga	-	1
Wellington	10	-
<b>Total</b>	<b>37 (95%)</b>	<b>2 (5%)</b>

Table 2.5 includes information on the general causes of the crashes, and reveals that the most common cause of drivers (20%) colliding with TMA can be attributed to distractions or inattentiveness. Drivers in this group were engaged in activities such as dozing off, speeding, racing or talking on mobiles.

Some crashes were caused by drivers whose vision was obstructed (13%) by the vehicle driving ahead of them, whereas others (8%) claimed that their manoeuvrability was blocked by traffic on the adjacent lane.

Intoxicated drivers account for 13% of those involved in crashes adding to the statistic that drink-drivers are a significant cause of crashes all over the country (LTNZ 2005b).

It appears that perception of TMA is generally understood throughout New Zealand society, as only 10% of those involved in crashes did not understand the message.

**Table 2.5 General causes of crashes into ATM.**

General cause	No. (%)
Distracted/inattentive driver	8 (20)
Vision obstructed	5 (13)
Intoxicated	5 (13)
"Did not understand"	4 (10)
TMA's crew fault	3 (8)
Manoeuvrability blocked	3 (8)
Vehicle technical failure	1 (2)
Unknown/unreported general cause	10 (26)
<b>Total</b>	<b>39 (100%)</b>

## 2.2 Near hits survey

A 'near hits' survey was then carried out, the main purpose of which was to describe incidents as briefly as practicable but with details such as: type of incident, road and

weather conditions, location, type of operation, TMA involved, and registration number of offending vehicle.

For this survey, incident (or crash) forms on which 'near hits' were to be entered and described were distributed throughout the roading industry between 16<sup>th</sup> of July 2004 and December 2004, with the purpose of monitoring traffic flow behaviour around TMA operations, and consequently to gain wider knowledge of the problem.

In total, 157 incident forms were collected and summarised below:

- 8 (5%) cases of 'actual hit' – *where a hit has occurred.*
- 132 (84%) cases of 'near hit' – *where a driver comes extremely close to contacting with the attenuator unit.*
- 17 (11%) cases of 'other' – *where a driver may come to a halt some metres back from a pad or be involved in some incident that follows because of the positioning of the attenuator.*

Even though most of these incidents did not incur any physical damage, nevertheless eight crashes occurred in the 6-month period.

The incident forms lodged in this incident history database showed some similar patterns. Most incidents occurred with Mobile operations (74%), with the remainder in Semi-static (16%) and Static (7%) operations. Again the statistics indicate that the problem mostly occurs on Level 3 roads (95%) where the use of TMA is mandatory.

### **2.3 Reasons for unifying traffic control devices**

As not enough detailed guidelines for size, colours, placement and types of VES (i.e. warning lights) are provided in Transit's CoPTTM (2004), several types of visually different TMA are operating on the New Zealand roads at the present time. This diversity is contrary to the fundamental need to unify traffic control devices and to simplify drivers' perceptions so they can react efficiently.

The Manual on Uniform Traffic Control Devices (MUTCD) Millennium Edition (FHWA 2000), the US equivalent to Transit's CoPTTM (2004), describes traffic control devices as:

*...all signs, signals, markings, islands and other devices used to regulate, warn, or guide traffic, placed on, over or adjacent to any street, highway, pedestrian facility, or bicycle path by authority of a public body or official having jurisdiction (FHWA 2000).*

CoPTTM requires that traffic control device features:

*should be evident to motorists so that they recognise the need to adjust their behaviour.*

Therefore, to be effective, a traffic control device should (Homburger et al. 2001):

- I. *Fulfil a need*
- II. *Command attention*



## 2. *Justification for the research*

---

- III. *Convey a clear, simple meaning*
- IV. *Command respect from road users*
- V. *Give adequate time for proper response*

These general characteristics can be obtained by unifying the use of and outlook of traffic control devices. Homburger et al. (2001) explains why uniformity for control devices is desirable, and these reasons are adapted below for this research.

Types of uniformity:

- *Uniform design* aids rapid recognition and comprehension by drivers, and this includes shape, colour, size, symbol, wording, lettering, illumination, and reflectorisation.
- *Uniform meaning* aids drivers to understand the message so they can comply with regulations.
- *Uniform operations or applications* promotes driver observation and improves their expectancy that similar conditions will exist by ensuring that the same type of device is used.
- *Uniform placement* aids the driver's visual task to see a control device. Standard locations assist them to conclude where the indicated action will take place.
- *Uniform maintenance* ensures that the control device meets its highest standard of performance, either during the day or night.

Importance of uniformity:

- *Government liability* may be likely with traffic control devices that do not comply with regulatory requirements because a roading company may have neglected compliance in order to make financial savings.
- *Driving conditions*, such as speed, traffic density, intersections, interchanges and roadwork zones, require control devices that drivers can perceive and respond quickly by undertaking appropriate action safely and in time.
- *The reason for designing traffic control device use* should be the driver who is unfamiliar with the road and any devices used on it. Thus, control devices having standard meanings can be interpreted the same way by both the driver and the road designer.

Applying these basic guidelines should reduce and even prevent the incident and fatality rate.

### **2.4 Summary**

The forms collected from the near-hits survey identified situations in which actual hits or near hits to TMA occurred. The survey showed a regular occurrence of incidents which suggests that urgent steps need to be taken to stop the fatal and serious injuries associated with TMA use.

Focus should be on the performance of the Tail TMA operating on the live lane. The positioning of an advance warning also needs to be evaluated because it has the potential to favourably affect the driving task and create safer conditions possibly by giving drivers an efficient message that a TMA is operating.

The types of crashes and the information in the incident reports suggest that human factors have caused, both directly and indirectly, a large number of the incidents.

However, drivers alone should not be blamed for all these incidents, many of which are related to poor traffic management techniques associated with visual and operational aspects of TMA that make visual perception difficult.

The lack of unification of the visual appearance of TMA is the other problem. To overcome the existing differences in TMA requires practices that will minimise potential hazards and will convey a clear, simple meaning to the driver. To command the attention of the driver, roadwork sites should be clearly identifiable and warnings positioned at distances that give adequate time for a suitable response.

### 3. Driver characteristics

#### 3.1 Introduction

If TMA are to be designed so that they are effective, a review of the physiological and psychological characteristics that enable a vehicle driver to respond and take action is required.

Driver perception–reaction performance in relation to TMA operations and related issues are the foundation of this research. Characteristics of the traffic stream can be classified into five critical components (according to Roess et al. 2004):

- road users,
- vehicles,
- road,
- general road environment, and
- traffic control devices (Figure 3.1).

Strong interactions are observed between and within each component, which actively or passively influence the shape of the traffic stream. As improving one component may weaken the other, keeping the system in balance is a challenge. For instance, rumble strips are effective speed reduction devices (Maze 2000) that cause vibrations to alert the driver, whereas vehicle designers attempt to generate a vibration-free vehicle suspension. An overview of characteristics of the road user (especially the driver) that roading engineers take into account while designing traffic control devices, primarily at roadwork sites, are reviewed here.

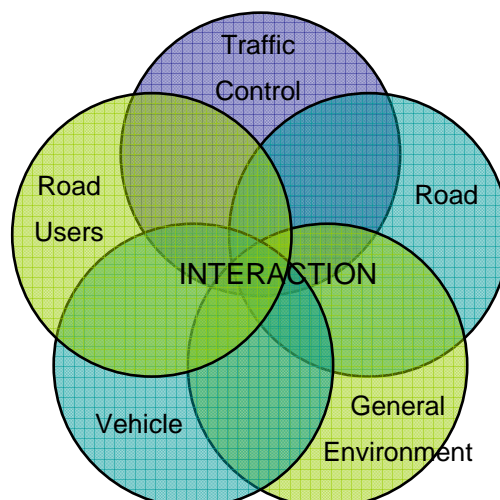

**Figure 3.1** Interaction of the five traffic stream components (Roess et al. 2004).

### Driver task–capability demand issues

Drivers travelling on the road continuously experience 'Task–Capability' demand issues and are positioned in a dynamic control point. The key driving task factors (Figure 3.2) suggested by Fuller & Santos (2002), which differ in terminology from that used by Roess et al. (2004), are:

- *general environment*, composed of the road condition such as roughness as well as vertical and horizontal alignment;
- *other road users* which may interact with a driver; and
- operational characteristics of the *vehicle*.

Two other factors for which the driver has high influence are *road position* and *vehicle speed*.

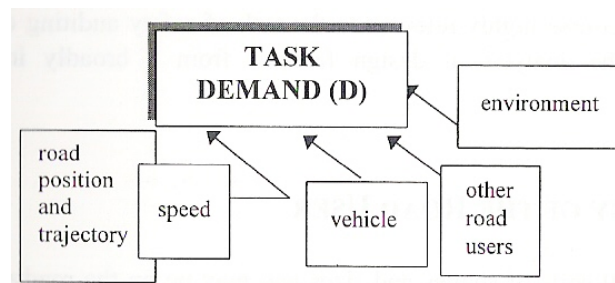

**Figure 3.2** Contributing factors to task demands of the driver (Fuller & Santos 2002).

Task demand significantly increases when a driver approaches a TMA or any type of roadwork operation and he/she is required to take proper action to react in a safe manner. This usually involves lane changing in advance, speed reduction, and increased awareness.

A driver has many physical and psychological characteristics which affect their capability of coping with task demands. Fuller & Santos (2002) stated that capability is a set of determinants, which can be portrayed as constitutional features (i.e. physiological), experience and training education, competence and human factors (Figure 3.3).

Constitutional characteristics or biological capabilities of the driver describe individual performance and these thresholds include information processing, reaction time and visual acuity. Competence combines experience and training education and specifies the upper limit of a driver's capability. However, it can be affected and decreased by human factors (Roess et al. 2004; Fuller & Santos 2002; Homburger et al. 2001) such as:

- Alcohol and drugs – alertness, reaction time, quality judgment and co-ordination are impaired and the driver's performance is reduced.
- Fatigue, drowsiness, mental condition (emotion, stress), distractions – all reduce reaction time.
- Age, disease and psychological ability and other factors – that interact with driver competence.

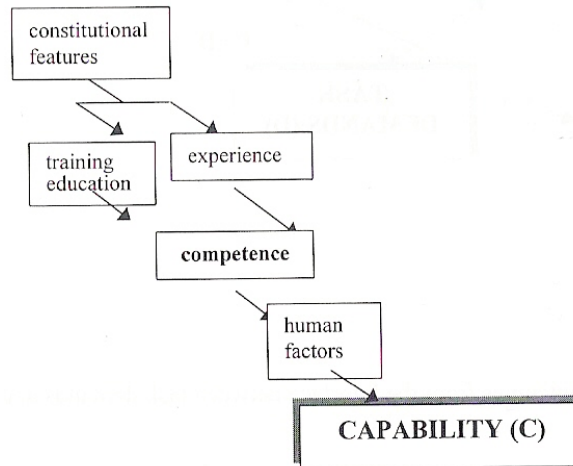

**Figure 3.3** Determinants of driver capability (Fuller & Santos 2002).

A simple model of the interference between task demand and capability, called the task–capability interference model, is presented in the following graph (Fuller & Santos 2002).

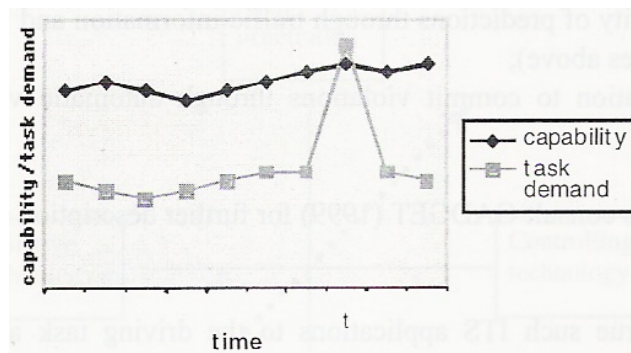

**Figure 3.4** Representation of dynamic relationship between task demand and capability over time, showing an acute episode where demand of the task exceeds driver capability (Fuller & Santos 2002).

The basic idea of this model is that the behavioural outcome of the driver on the road is the relationship between the driving task and the driver’s available capability. Up to time ‘t’, capability exceeds demand hence the driver safely corresponds to the traffic flow and road environment. However at point ‘t’, demand exceeds available capability resulting in loss of control which may result in an incident.

Crash analyses estimate that 26%–56% of all crashes are caused by failure to recognise roadway hazards (Treat 1979, cited in Charlton 2004). If reduced visibility and recognition of TMA is one of the primary direct causes of increased crash risk, the combination of existing technologies and operational solutions can reduce crash risk by providing enhanced visual cues to drivers hence improving their perception–reaction time (PRT).

## 3.2 Perception–Reaction Time (PRT)

A critical driver characteristic is perception–reaction time (PRT) and, according to Roess et al. (2004), this includes four distinct tasks that the driver has to perform:

- Detection – in this phase the unidentified object or condition appears in the driver’s vision and the driver becomes aware of the need to respond to it.
- Identification – at this stage, the driver is able to identify the object or condition because sufficient information about it has been acquired.
- Decision – after the object or conditions are identified, the driver must make a decision on how to respond.
- Response – after the decision is selected, the physical response is implemented.

The total amount of time required for these four tasks is called the *perception–reaction time* (PRT). Fambro (1997), cited in Homburger et al. (2001), reports that mean PRT for unexpected situations is about 1.1 seconds (s), whereas the 95<sup>th</sup> percentile time is 2.0 s. For an expected obstacle the mean PRT is 0.65 s. The consensus in the literature suggests that almost all drivers are capable of responding to an unexpected hazard in 2.0 s or less.

From a traffic safety analysis perspective the longest response needs to be assumed, and 0.5 s is added for implementing the response action such as breaking or indicating lane change. Therefore a value of 2.5 s is typically used for design and operation analysis purposes. PRT is modified if a driver is affected by one or more of the factors listed in Section 3.2 above. Weather, time of day, ventilation (affecting alertness), and light can also have an impact on physical and psychological responses (Homburger et al. 2001).

The most critical impact of the time expended during perception–reaction is the reaction distance (Roess et al. 2004; Ogden & Bennett 1996), which is the distance the vehicle travels while the driver goes through the perception–reaction process. Two types of situations are usually observed:

1. the driver travels with a constant speed through the PRT process, and
2. the driver with increased awareness starts to change the initial speed though the PRT process (most likely to decelerate).

The reaction distance values at constant and variable speeds can be computed from equation 3.1.

- (1) Constant speed:

$$D = V_i \times t \quad \text{Equation 3.1}$$

where:

- $D$  – reaction distance (m)
- $V_i$  – initial speed (m/s)
- $t$  – perception–reaction time (PRT) (s)

For example, if a driver is approaching a stationary TMA and the driver is already within VES legibility distance, and assuming that the driver is travelling at 100 km/h (28 m/s) and his/her perception–reaction time on the motorway is 2.5 s (Transit NZ 2000; Austroads 1993), then the vehicle travels 70 m before the driver’s response is implemented.

(2) Variable speed:

If acceleration is unknown:

$$D = \frac{V_i + V_f}{2} t \quad \text{Equation 3.2}$$

If acceleration is known:

$$D = V_i t + \frac{a}{2} t^2 \quad \text{Equation 3.3}$$

If PRT is unknown:

$$D = \frac{V_f^2 - V_i^2}{2a} \quad \text{Equation 3.4}$$

where:

- $D$  – reaction distance ( $m$ )
- $V_i$  – initial speed ( $m/s$ )
- $V_f$  – final speed ( $m/s$ )
- $a$  – acceleration ( $m/s^2$ )
- $t$  – perception–reaction time (PRT) ( $s$ )

For example, in the same situation as the previous example, if a ‘far sighted’ driver instead decelerates with a value  $-2 (m/s^2)$  through the PRT process, then the vehicle travels 63.75 m before the driver’s response is implemented.

### 3.3 Manoeuvring time

In case of lane closure at roadwork sites, after the PRT process is completed a driver is required to complete a manoeuvre, and the type of manoeuvre required can add significantly to the total time required.

For a lane change, *manoeuvring time* is a sum of the time required to search for a gap in traffic and the time to actually change lane (Collings 2004; Lerner 2004). Gap search time increases as traffic volume increases, since it is more difficult to find suitable gaps in traffic. Another related factor for gap searching opportunity is the drivers’ level of aggressiveness towards each other, which results in drivers driving up close to another car (Schreckenberg 2004). This behaviour can be observed at roadwork sites where many drivers fail to adjust for the interruptions and delays produced by the construction activity, which results in high-risk behaviour and frustration (ITE 1993). The time to actually perform the lane change, when the gap is available, is typically 3.6 s (Transit NZ 2000).

Information processing and task demand while the driver approaches roadwork sites can be improved. This is reliant mainly on the driver's vision. For example, using advance warning provides drivers with visual information about an unexpected road layout ahead (i.e. lane closure), reduces their mental workload, and therefore they can respond quickly. Hence most of the technology available and used for enhancement of unexpected hazards on the road is visual.

### **3.4 Driver vision**

Light plays an important part in vision, but before it can be sensed the object must first be transformed into optic nerve impulses by the receptors in the retina of the eye. Visible light is a band of electromagnetic energy with a wavelength between 380 and 720 nm (Kuhn 1997). The nerve impulses must travel a long and complex path to the visual cortex where they are perceived (Goldstein 1989, cited in Blanco 2002; Lay 1984). Perceived light in the road environment is reflected from objects and provides information about the nature of the object (Blanco 2002; Kandel et al. 2000; Kuhn 1997).

The receptors, responsible for creation of shapes and colours, are the rod and cone cells in the retina. Rods are monochromatic and are in charge of Scotopic vision (for dark conditions) and peripheral movement detection. Cones are polychromatic and are in charge of Photopic vision (for normal daylight conditions) and detection of detail (Kandel et al. 2000; Kuhn 1997). Cones, located in the fovea-centralis area of the retina, enable detection of small-sized objects and details.

During the night, the rod cells take over in these conditions of lower light intensity and are therefore responsible for night vision. As they do not pick up details, the driver's perceptivity of the road environment is less, and the ability to retrieve details of a scene is reduced.

This scotopic vision will detect an object, but once the object is illuminated by light and reflects that light beam to the most sensitive part of the retina, the fovea-centralis, then photopic vision will be activated for the retrieval of detail enabling more accurate identification.

### **3.5 Visual acuity and contrast sensitivity**

Visual acuity is the capability of our eyesight to determine detail at optimum levels of light conditions, whereas contrast sensitivity is our ability to detect objects under different contrast levels.

Even a person with good visual acuity can have their vision reduced under some conditions, such as rain, snow or at night. The visual acuity and contrast sensitivity of a TMA could, therefore, be the key to making them easier to identify. Both acuity and contrast can be adjusted through quantity or quality techniques.



The object needs to be larger (i.e. quantity method) if the contrast between an object and the background is low, whereas in a quality method, the aim is to give better contrast to smaller objects.

There are many definitions of contrast sensitivity, but the fundamental ones are

1. modulation contrast,
2. luminous contrast, and
3. contrast or luminance ratio (Kuhn 1997).

These definitions are formulated in equations as shown below:

$$\text{Modulation Contrast} = (L_{\max} - L_{\min}) / (L_{\max} + L_{\min}) \quad \text{Equation 3.5}$$

$$\text{Luminous Contrast} = (L_{\max} - L_{\min}) / L_{\max} \quad \text{Equation 3.6}$$

$$\text{Contrast or Luminance Ratio} = L_{\max} / L_{\min} \quad \text{Equation 3.7}$$

where:

$L_{\max}$  = maximum luminance

$L_{\min}$  = minimum luminance

Various factors and characteristics of both the road environment and the driver influence visual acuity and contrast sensitivity. For example a stronger light or background luminance activates the cones resulting in higher acuity and sensitivity (Sanders & McCormick 1993).

Kandel et al. (2000) states that, although no link between poor eyesight and crashes until about the age of 50 has been proved, eyesight can start to deteriorate between the ages of 30 and 40. Even at relatively young ages, a range of eyesight conditions may exist which, if identified early enough, can be treated to stop or reduce the effects of long-term deterioration.

Glaucoma and cataracts are perhaps the most well known conditions. Diabetes and other age-related diseases, if left unidentified and untreated, affect vision seriously enough to prevent safe road use (Roess et al. 2004). In addition, some people who have been prescribed correcting lenses do not use them when they are driving. This not only puts them at greater risk, but also puts other more vulnerable road users at risk.

Additionally, contrast sensitivity decreases as driver's age increases (Kandel et al. 2000) and therefore, for most elderly drivers, driving at night is a very difficult task. However, research by Helmers et al. (2004) refutes the idea that elderly drivers are dangerous drivers because of their general health conditions, poor eyesight and multi-tasking co-ordination, etc. The author proves that elderly drivers are not involved in more crashes than middle-age drivers, and that younger drivers are the most dangerous drivers. However, from the public health perspective the probability of older drivers being seriously injured or killed in a crash is still greater than for other age-group traffic users.

Additional factors reducing visual perception, but influencing all the drivers and particularly the elderly, is motion. Roess et al. (2004) states that acuity and field of vision decreases with increased relative motion of the object, or the observer (or both).

People with attention impairments are likely to have difficulties with selecting relevant information from the road environment, especially when a lot of information is exposed at a high rate (i.e. at higher speed).

### 3.6 Psychological background to sign design

Well-placed and well-designed signs play an important role in the way a driver interacts with the road environment. The visual appearance of the safety device, in this case TMA, should be adjusted to suit the characteristics of the driver on the road in order to help the driver in their visual task (Kamyab 2002; Fuller & Santos 2002). The background of road sign design may play a supportive role in this study.

The principle of sign design is to be visually effective. In terms of visibility, it needs to be detectable and readable at the minimum required distance at which the driver can understand the sign's content, and therefore react in a safe manner. Hence, the readability distance of any traffic safety features, such as a mounted sign or arrow board, should be identified far beyond the minimum requirement because the sign must be detected before it can be read (Roess et al. 2004). Such detection distance improvements can be obtained by working on and unifying the visual acuity, such as contrast sensitivity, of TMA features. These include sign colour, colour contrast, and night-time illumination techniques. These characteristics of sign visibility are dependent on the following measures (Kuhn 1997):

- luminous intensity
- illuminance
- luminance
- reflectance

The photometric relationship between those four terms is described in Figure 3.5.

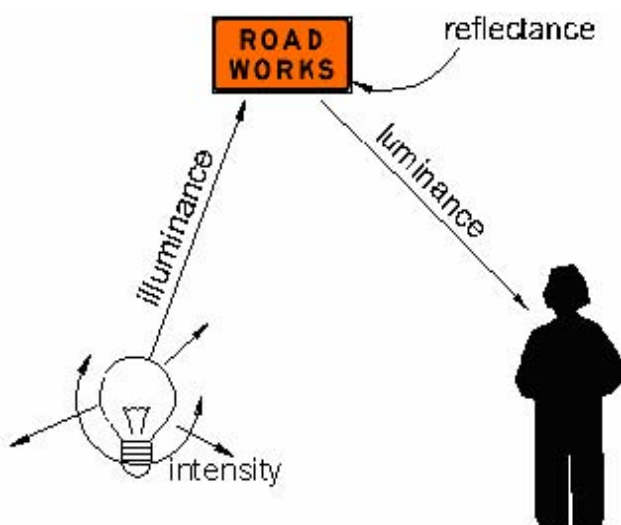

Figure 3.5 The photometric relationship between reflectance, luminance, illuminance and intensity.

Internal illuminance may be achieved by a light within or behind the sign face illuminating the sign message, whereas external illumination is achieved by attaching an independent source of light (i.e. rotating beacon) (NAASRA 1988).

Research undertaken by Kuhn (1997), based on human observations, suggests that different sign characteristics influence recognition and legibility distances. These significant characteristics include illumination technology, contrast orientation, text and background luminance, luminance ratio, and spacing between text letters. Furthermore, his research indicates that the viewing audience influences these distances.

This view is in accordance with other researchers (Fuller & Santos 2002; Blanco 2002) who agree that younger drivers (ages 30-45) outperform older ones in this respect. This is caused by decreased contrast sensitivity as driver's age increases. For instance, older drivers require more contrast between a sign message and its background to distinguish the message (Helmers et al. 2004; Fuller & Santos 2002; Kuhn 1997), and is related to age-related reduction of visual acuity, low luminance and sensitivity to glare (Kandel et al. 2000). Also, Kuhn's (1997) further findings indicate that both recognition and legibility distances increase for internal illumination with opaque and translucent background which outperform external illumination for both day and night-time viewing. He also pointed out that recognition distance increases if the text luminance increases, but recognition distance significantly decreases as background luminance increases.

These tendencies show that positive sign contrasts are better than negative sign contrasts. An increase of luminance ratio causes recognition distance to decrease, most likely caused by the extremely high luminance ratios that result in irradiation of letters or signs that reduce visibility (Kuhn 1997). Therefore, external and internal translucent illumination technologies both have a negative effect on recognition distances.

### **3.7 Summary**

Designing a safe environment for roadwork crews and motorists is dependent on several issues but especially on visual aspects related to driving activity. The physiological characteristics of sight for a vehicle driver mean that adequate distance must be allowed with plenty of advance warnings provided so that a driver can respond, react, and take action in time. Warnings of roadworks ahead, to reduce speed, change lane, etc. must have suitable contrast, be readable from a distance, and positioned well in advance of the changed condition.

Physiological capabilities of a driver describing individual performance that have been taken into consideration by roadwork equipment manufacturers and by the national transportation authorities in management of roadwork sites, should result in the appropriate procedure for roadwork sites. Understanding of these fundamental facts on human physiological characteristics is aimed at adjusting available technology to improve the perception–reaction time of a driver, and to extend their competence within the traffic flow. The effects of advance warning are reviewed in the following chapters.

## 4. Truck mounted attenuators

### 4.1 Functions of TMA

TMA play a major role at high-risk operations at roadwork sites in the perception-reactions of drivers. This chapter outlines their main functions and features.

The main functions of a TMA unit are to provide advance warning of a hazard on the road ahead (when used as a Tail Pilot vehicle), to direct traffic into an open and available lane (when used as Tail Pilot and/or Shadow vehicle), to provide protection to work crews and equipment on the work site (when used as a Shadow vehicle), and protection for road users in the event of a collision with a Tail Pilot or Shadow vehicle fitted with a TMA unit. TMA play a major role at high-risk roadwork activities involving heavy machinery and workers on a live lane (i.e. one that is in use by vehicles).

Activities that are most commonly considered to be high risk are mobile roading operations including:

- road marking,
- installing or removing raised pavement markers,
- pavement testing, road inspections and similar operations such as road skid and roughness testing,
- mowing,
- weed spraying,
- shoulder grading,
- pavement sweeping (litter and debris pick up),
- cleaning cesspits, sumps or service holes (for underground services),
- marker post maintenance,
- installation of signs for road closures,
- sight rail and road safety barrier repairs,
- pothole repairs,
- snow clearing or spreading grit.

The main characteristics that these operations have in common are short-term work operations or moving activities carried out within the road reserve. Thus using repetitive advance warning is usually restricted to short distances or times around the actual worksite.

### 4.2 Features of TMA

TMA are trucks that have a safety appliance to dissipate the energy of a rear-end collision mounted on the rear. They consist of:

- an Attenuator or Crash Cushion (explained in Section 4.2.5) which has the same basic energy-absorbing principles as the stationary crash cushions that are used to protect permanent roadside hazards, and
- a Message Board, the main purpose of which is to warn the traffic to change lane. It informs drivers of vehicles about the roadwork in advance so that they can respond in a safe manner. It consists of the following safety devices:
  - Arrow board (Section 4.2.1),
  - Warning lights (Section 4.2.2),
  - Warning signs (Section 4.2.3), and
  - Retroreflective tape (Section 4.2.4).

To prevent crashes and serious or fatal injuries, both safety devices (attenuator and message board) must meet the highest safety requirements.

#### **4.2.1 Arrow Board**

The aim of the Arrow Board safety device, which has directional arrows depicted in flashing yellow lights, is to:

- make a TMA more recognisable from the rest of the traffic by flashing lights,
- direct traffic to the open lane, and
- reduce driver's confusion and mental workload of undertaking a required action.

Two types of Arrow Boards are available on the market, with the major difference being the angle of arrow displayed – *horizontal* (Table 4.1) or *skewed* (Table 4.3). Detailed specifications of the *horizontal* arrow are presented in Table 4.2.

Lighting arrows on the Advance Warning *Skewed* Arrow Display comprise 13 or 25 halogen or LED lamps, 200 mm Ø, which can be switched right or left (as shown in Table 4.3) or as a cross of lights. Mounted on the top corners of the Message Board are two lamps of 340 mm Ø, either as electronic xenon flash or halogen lights.





#### **4.2.2 Warning lights**

Mounting warning lights on TMA is common practice around the world. The purpose is to:

- warn motorists of maintenance vehicle activities on a road or near the roadway, to
- advise drivers to react in advance, to
- define size and shape of the vehicle, and to
- convey the intent of the TMA (MUTCD, FHWA 2003).

Many different warning lights are available on the market that can be used on TMA, and the differences between them are based on colour, method of flashing, intensity of and rate of flashing. However, currently no clear indication is given of the most efficient set-up for TMA.

**Table 4.1 Advance warning horizontal arrow display specifications (MUTCD FHWA 2003).**

Operating Mode	Panel Display (Type C panel illustrated)
I. At least one of the three following modes shall be provided:	(Right arrow shown; left is similar)
Flashing Arrow	 Move/Merge Right
Sequential Arrow	 Move/Merge Right
Sequential Chevron	 Move/Merge Right
II. The following mode shall be provided:	
Flashing Double Arrow	 Move/Merge Right or Left
III. The following mode shall be provided:	
Flashing Caution	 Caution

**Table 4.2 Advance Warning horizontal arrow size specifications (MUTCD FHWA 2003).**

Panel Type	Minimum Size	Minimum Legibility Distance	Minimum Number of Elements
A	1,200 x 600 mm (48 x 24 in.)	0.8 km (1/2 mi)	12
B	1,500 x 750 mm (60 x 30 in.)	1.2 km (3/4 mi)	13
C	2,400 x 1,200 mm (96 x 48 in.)	1.6 km (1 mi)	15
D	None*	0.8 km (1/2 mi)	12

\* Length of arrow equals 1,200 mm (48 in.), width of arrowhead equals 600 mm (24 in.). (mi = mile).

**Table 4.3 Advance warning skewed arrow display specifications**  
(Schonborn/Schulte 1995).

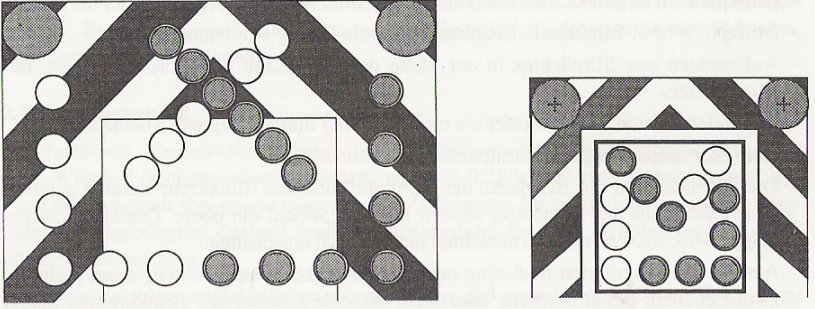
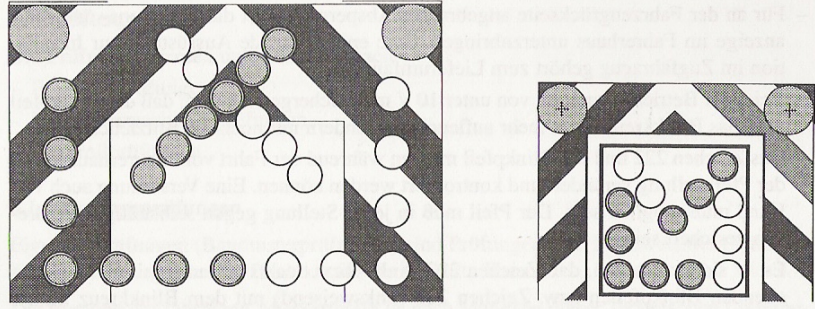
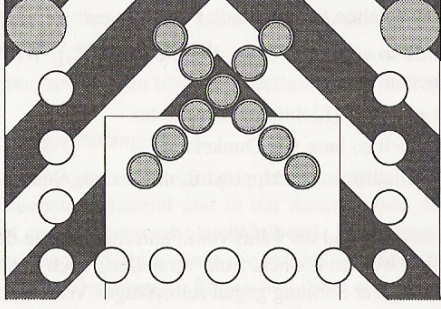
Operating Mode	Panel Display
<p>I. At least one of the following two modes shall be provided:</p> <p>Flashing Arrow Right</p>	 <p style="text-align: center;">Move/Merge Right</p>
<p>Flashing Arrow Left</p>	 <p style="text-align: center;">Move/Merge Left</p>
<p>II. The following mode shall be provided:</p> <p>Flashing Caution</p>	 <p style="text-align: center;">Caution</p>

Key to colour of lights: shaded = yellow lights on; white = lights off

A study by Hanscom & Pain (1990, cited in Kamyab 2002) undertaken in the US, developed some guidelines for warning lights in temporary stationary and mobile operations on efficiency of the warning lights on the maintenance vehicles. The first study, which took place on a newly constructed four-lane divided highway, suggested that:

- Adding more of the same type of warning light to the maintenance vehicle does not improve the input of information to the driver. The new light must be seen from all directions.

- Combining a roof-mounted flasher light with rotating light increases the flow of information to the driver.

The second study undertaken in the field experiment indicated that:

- The warning-light bar gave the best performance.
- Two rotating flashing lights, together with two side-mounted eight-inch flashers, were very effective.
- Truck visibility was not improved by using double-flash strobe lights instead of standard rotating lights.

The main conclusions which can be drawn from these studies, are:

- An all-amber-light bar system with rotating elements was effective for mobile operations.
- A combination of rotating beacons with flashing strobe lights was effective in both mobile and stationary operations.
- A combination of blue and amber rotating beacons, compared to amber lights only, resulted in significant speed reduction.

The last conclusion indicates that drivers misinterpret TMA to be police enforcement, the latter being one of the most effective speed-reduction management techniques for roadwork sites (Maze 2000), and generally very effective in other roading enforcement techniques (Nilsson 2004). Kamyab (2002) conducted a US national survey, through the State Department of Transportation, in addressing traffic control needs for moving operations. The responses on colours for use in warning lights were as follows:

- Amber-coloured warning lights, either exclusively or with other colours, are used by all the state agencies who responded to the survey.
- A mixture of white, amber, and red are preferred in Alabama and Rhode Island.
- Amber and blue are used in Alaska, Colorado, and Mississippi.

Some countries (UK, Germany, Sweden, several US states) use rotating beacons and/or strobe lights on maintenance vehicles. In recent years mounting strobe lights with a minimum diameter of 8 inches (20 cm) has become more common, not only on the trucks but also on school buses, emergency-response vehicles, or road signs that need special attention from drivers.

For example the Missouri Department of Transportation complied with this practice as it believed that strobes improve conspicuity and thus are easier to see farther away (Kamyab 2002). Strobe lights not only serve the same purpose as the rotating lights, but they also increase safety near the TMA. The reason is that a beacon light tends to blind motorists as they get closer to the source of the beam. However a halogen or strobe light has a narrow beam, and on approaching the TMA, the driver moves out of the beam's glare (Adolf 2004; Kamyab 2002).



### **4.2.3 Warning signs**

TMA usually have warning signs attached to the rear Message Board. The most common symbolic sign are 'Men on the Road' sign (TW-1) along with RG17/RG34 directional signs. Some countries require in addition a descriptive 'wordy sign' which describes in words what is the activity on the road, for example 'road work', 'mower' 'road marking', etc. However, the effectiveness of wordy signs has been under debate since their implementation. For instance the early study undertaken by Sanderson (1972), whose aim was to compare New Zealand wordy signs with international symbol signs, concluded that international signs were far superior to the New Zealand wordy signs for rapid recognition.

The reasons might be many, and among them are longer time required to identify wordy signs and mental overload. Reading time ranges between 0.3–0.75 seconds depending on the driver's familiarity with the word. However if the word is unfamiliar, it may take several times to read this and comprehend, and in fact many may never be fully understood by many drivers. Such signs should be avoided (Ogden & Bennett 1996).

### **4.2.4 Retroreflective tape**

The ability of the surface to return the light back to its source has the technical name 'Retroreflectivity'. One key solution to improve the visibility and detection of the road hazard, which the driver may encounter while approaching the roadwork site, is to use retroreflective tape on the road controlling devices. Many types of retroreflective tape are available on the market and each of them has its certain colour and purpose, e.g. sheeting of signs, cones, barriers, pavement marking, workers' clothing, and vehicle marking.

Retroreflectivity, and therefore night-time visibility enhancement, of safety devices provide (from FHWA, 2005 online resource):

- critical information to the driver;
- navigation for the driver during night conditions, and therefore improvement of the traffic flow;
- promotion of safe driving.

The US FHWA statistics, published on their website (2005 online resource), state that, for the last 25 years, 50% or more of the fatal crashes have occurred at night even though the roads carry much less traffic then. Recent studies undertaken worldwide show that conspicuity markings significantly improve visual information processing, resulting in faster and more accurate decision-making by drivers (Charlton 2004; Blanco 2002; Kamyab 2002; Morgan 2001; Carlson 2000; Fontaine 2000; Hanna 2000).

A study by Morgan (2001) showed that drivers rely on what they can see, therefore reflective marking reduces the probability of serious accidents. Morgan also researched the effectiveness of retroreflective tape, undertaken in the US in dark conditions including 'dark-not-lighted', 'dark-lighted', 'dawn', and 'dusk'. Overall the research suggested that retroreflective tape reduced side and rear impacts into trailers in dark conditions by 29%.

In 'dark-not-lighted' conditions only, the tape was even more effective and reduced side and rear impact crashes by 41%.

The other conclusion was that the tape was especially effective in reducing injury crashes in dark conditions by 44% for side and rear impacts that resulted in fatalities or injuries to drivers of any involved vehicle.

The following considerations for use of retroreflective tape to give better visual information, are particularly important:

- Horizontal and vertical changes in roadway alignment;
- Dirty misaligned headlights of motor vehicles;
- In older drivers, loss of visual acuity and of ability to react quickly.

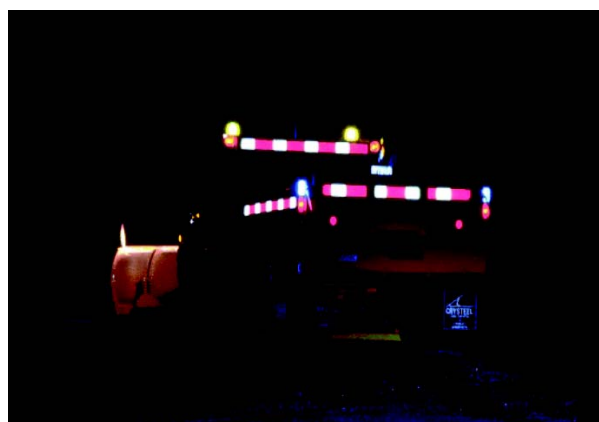

**Figure 4.1** Identifying maintenance vehicles using retroreflective tape.

Figure 4.1 shows examples of the effectiveness of retroreflective tape markings using strips that enhance visibility and identification of the heavy vehicles from all directions. These markings make the shape and size of trucks brighter and easier to see at night.

#### **4.2.5 Attenuator**

Attenuators, also known as crash cushions or energy absorption cartridges, play a major role in saving human lives. This safety device is mounted to the back of a truck being used to warn of either moving or stationary roadwork sites. Besides saving lives of road users, it also protects work crews from errant vehicles and protects the drivers who operate TMA.

A crash cushion or attenuator is attached to the truck by means of a rigid frame, a steel support structure, and an under-ride system (which can collapse under the vehicle). Its purpose is to evenly and gradually dissipate the kinetic energy of an impacting vehicle. A crash cushion also prevents an impacting vehicle from riding under the truck body, which can result in shearing off the top of the impacting vehicle at the bonnet line.

Government agencies around the world require TMA to:

- meet all vehicle requirements recommended by the manufacturer of the TMA;
- be legally permitted to travel on the road;

#### 4. Truck mounted attenuators

- be certified for compliance with NCHRP Report 350 Tests 50 and 51 (cited in CoPTTM).

Test Level 2 (70 km/h impact) is the usual basic test level applied in New Zealand that TMA must meet before they are used on roads that have a permanent posted speed limit greater than 70 km/h. Transit NZ (2004) suggests that for New Zealand roads Test Level 2 requirement is also effective for crashes at speeds greater than 70 km/h.

The weight of the truck plays an important role in efficient impact reduction process. The figures in Table 4.4 were taken from US FHWA approval letters (Griffith 2003; Sillan 1994, 1996, 1997; Taylor 2002; Wright 2000), according to which any TMA units which are mounted on trucks below or above the required weights will not comply to NCHRP-350. Particular care must be taken not to overload the truck on which the TMA is to be mounted, and thus a truck shall not be heavier than 20,000 kg in total. A heavier truck with stiffer suspension will vibrate more when impacted, causing premature damage to the TMA.

**Table 4.4 Comparison sheet for different attenuator models.**

Manufacturer	Model	Level of road	Weight (kg)	Cushion length (mm)	Suggested tare of vehicle (kg)
Trinity Industries	MPS-350	3	825	4100	7,000
Energy Absorption	Safe-Stop 180K	3	940	4400	8,550
RENCO	100K	3	499	3350	8,845
Scorpion	10,000C	3	878	3560	9,000
RENCO	70K	2	463	2300	4,536
Energy Absorption	Alpha 70K	2	550	2521	5,000
Scorpion	10,000A	2	629	2060	9,000

Although an attenuator reduces the stress on the vehicle and its occupant in a collision, it does not stop a truck from rolling or sliding forward when struck from behind. For example, in two Caltrans tests (quoted in Griffith 2003), an 11,600-pound<sup>5</sup> truck with front and rear brakes locked, on dry pavement, was struck directly in the rear by a standard sedan at 45 mph. It moved forward 10 feet (3 m) without an attenuator, and 10 feet (3 m) with an attenuator. Therefore positioning the protective vehicle so that it protects the workers must be carefully judged.

Figure 4.2 is a series of photographs of an impact of a 1,998 kg heavy pickup truck, travelling at a speed of 96.4 km/h with an Energy Absorption *Safe-Stop 180K Crash Cushion*. The photos show (top left) the collision of the blue truck (on left) with the white crash cushion (on right), the crash cushion collapsing (see next 3 photos in the sequence), and the crash cushion rolling out of frame in the last phase of the collision (bottom right).

<sup>5</sup> 1 pound = 0.45 kg; 11,600 lb = 5220 kg  
1 mph = 1.6 kph or 45 mph = 72 kph; 1 foot = 0.3 m



**Figure 4.2 Safe-Stop 180 kph Crash Cushion impact (Griffith 2003).**

This series of photos shows how the TMA absorbs an impact: (top left) collision of blue truck with white crash cushion; (top middle & right) crash cushion crumples; (bottom left & middle) complete collapse of crash cushion; (bottom right) collapsed crash cushion + truck rolled out of frame.

## 5. Review of New Zealand TMA practice

Research had not been carried out in New Zealand, as at 2004, on the performance of different configurations for the visual outlook of message boards mounted on TMA. However, several industry studies on traffic control devices, traffic management, safety within roadwork sites, and driver's perception–reaction time, have been made both in New Zealand and internationally. These studies will bring a better understanding to this research, of the effects of certain actions, and advice on the methods and technologies that can be used to maintain integrity and support of the existing roading codes of practice (e.g. Transit CoPTTM 2004).

Crash analyses estimate that 26% to 56% of all incidents are caused by failing to recognise roadway hazards (Treat 1979, cited in Charlton 2004). If reduced visibility and recognition of TMA are the primary direct causes of increased crash risk, the combination of existing technologies and operational solutions should reduce crash risk by providing enhanced visual cues to drivers.

The Transit NZ Code of Practice for Temporary Traffic Management (CoPTTM 2004) is the official regulation for the roading industry in New Zealand. Not only does it serve as a baseline for constructing a management plan for roadwork sites, but it also specifies the requirements for the vehicles engaged in these operations. This chapter presents an overview of TMA practices in New Zealand.

### 5.1 Development of TMA practice

The term 'Mobile Closure' in which TMA were used, first appeared in the High Capacity Highway (HCH) Code of Practice (Transit 1997) where it was defined as work which required planned stops of no more than 10 minutes that is not contained within a fixed site. As well, no static signs or cone tapers had to be set out. By 2004, the latest edition of CoPTTM (2004) describes two types of mobile operation:

*(a) Mobile Closure: A normally continuously moving activity or work operation carried out **within the road reserve** that may also stop briefly at a particular location for a period of no more than ten (10) minutes.*

*(b) Semi-Static Closure: A short-term activity or work operation that is carried out **on the carriageway of a road** at a particular location that takes more than ten (10) minutes, and less than one (1) hour, to complete. However, cones must be placed between the Shadow vehicle and the Work vehicle(s), and a cone taper must be installed in advance if necessary.*

The vehicle or vehicles associated with the mobile operation travel along or on the road in the direction of the traffic flow, usually at slower speed.

As maintaining safe working practices is a principal goal when carrying out mobile operations, the number of devices should not be compromised just because the operation changes location as it moves along the road.

The New Zealand roading industry has gained knowledge from overseas partners and through local experience, and are adjusting features of their TMA to help drivers identify and respond effectively. Figure 5.1 presents the progress and improvements made to the visual appearance of the Message Board.



original set-up                      for high intensity traffic    'Smartstop' stoplights    combination of all  
Figure 5.1    Some improvements made to the visual appearance of TMA.

Each of these set-ups is in accordance with CoPTTM (2004). The 'Smartstop' stoplight system has been developed by the roading industry so that the TMA driver can activate the flashing mode for the LED panels to alert drivers who approach the TMA too closely.

## 5.2    HCH COP 1997 practice

Figure 5.2 shows HCH Code of Practice 1997 guidelines (Transit 1997) for a multi-lane one-way Level 3 road. It is the first attempt at providing guidance for Mobile Operations for working industry groups. The Shadow TMA is positioned 40–60 m behind the working vehicle and 100–600 m in front of the Tail TMA operating on a live lane.

## 5.3    CoPTTM 2004 practice

CoPTTM's (2004) sections D (Mobile Operations) and E to G (Level 'Low Volume' to Level 3 Roads – Signs and Layout Diagrams) give detailed information on standards and guidelines for mobile operations.

### 5.3.1    Requirements of a TMA

The TMA, according to the CoPTTM regulations, must consist of:

- a Message Board, and
- a Crash Cushion which is certified for compliance with NCHRP Report 350 Tests 50 and 51 (cited in Transit CoPTTM 2004) for the Test Level 2 (70 km/h impact), and affixed in accordance with the manufacturer's specifications.

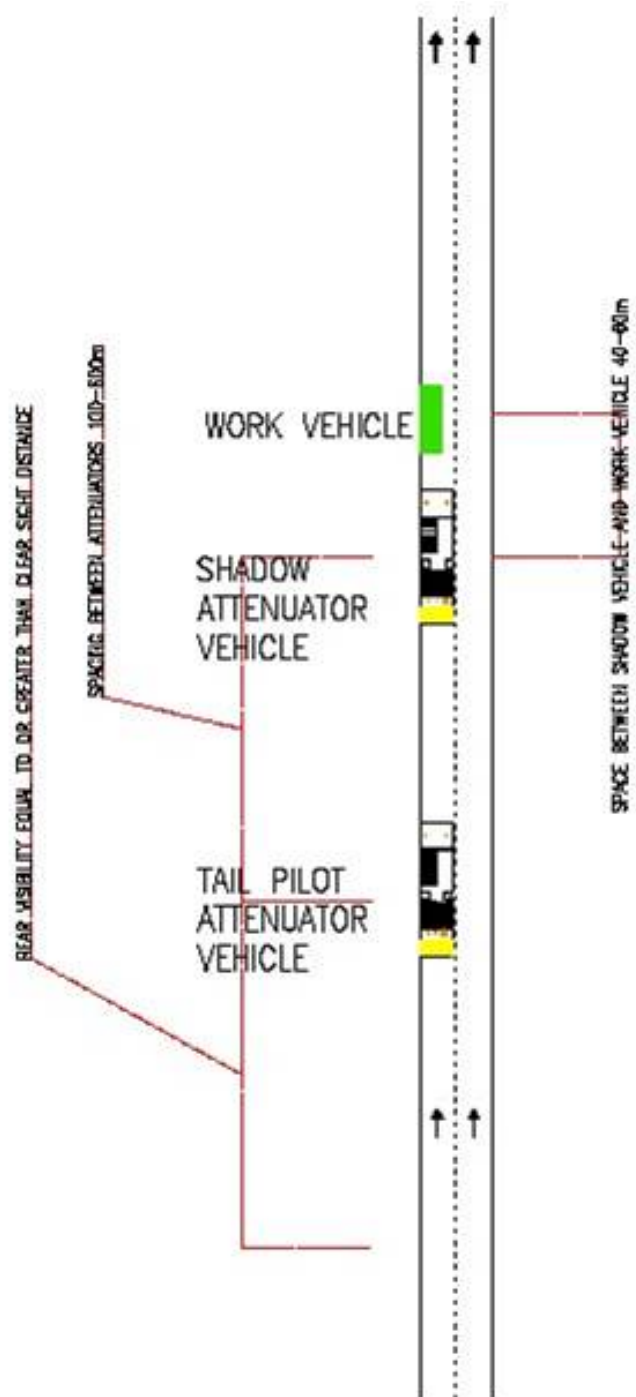

Figure 5.2 Mobile closure for multi-lane divided or multi-lane one-way Level 3 road. Work vehicle is on the carriageway (from HCH Code of Practice, Transit 1997).

- Each TMA used in mobile operations on Levels 1, 2 and 3 roads is required to have a mounted horizontal arrow panel operating in a Single Sequential Arrow Mode or in a Caution Mode with a 25 to 40 flash rate per minute (Table 4.1).
- Number of lamps must be at least 25 with a minimum diameter of 80 mm and of amber colour.

**Arrow Boards** should be legible at distances greater than 800 m and these are shown in Table 4.2. They must comply with the requirements of the joint AS/NZS 4192 standard (Illuminated flashing arrow signs) preferably, with the Millennium Edition of the US FHWA (2000) Manual on Uniform Traffic Control Devices, Section 6F-53: Arrow Panels and Figure 6F-3: Advance Warning Display Specifications.

The Arrow Board size is dependent on the Level of road:

- on Levels 1 and 2 roads, Arrow Boards must be at least 1200 mm wide by 600 mm high (Type A), and
- on Level 3 roads must be at least 1500 mm wide by 700 mm high (Type B or preferably Type C) (Table 4.2).

Other specifications for TMA visual appearance include:

- adjusting the Arrow Board light intensity depending on the time of day (day – maximum intensity, night – half maximum intensity); and
- mounting a warning sign underneath the Arrow Board informing motorists of the type of work ahead.

When the TMA is in a live lane, and a minimum lane width is available for traffic to safely pass on one side of the vehicle, the arrowhead is moved left or right depending on the direction in which drivers are being directed.

When a minimum lane width cannot be provided on either side of the vehicle or if the TMA is on a shoulder and the carriageway is entirely unaffected, all four corner lights of Arrow Board should be flashing simultaneously (Table 4.1).

**Visibility** Alongside the Arrow Board, at least one, and preferably two, yellow or amber beacon lights must be mounted and turned on. Flashing beacons can supplement other traffic control devices where additional emphasis and warning for drivers is desired. According to New Zealand regulations (Transit CoPTTM 2004), these should be fitted on the roof of the TMA, where workers and other road users will have a clear view of them at all times. When operating together with an Arrow Board, they must be turned off or positioned so they do not impair the performance of the Arrow Board.

As many road activities take place at night, retroreflective and/or illuminated devices should be used on the TMA in the operations. The implementation of these safety devices should be in accordance with the requirements of the manufacturer who will provide the marking guidance for each vehicle type for optimum visibility.

**Weather and traffic conditions** The Transit CoPTTM (2004) regulations require weather and traffic conditions to be favourable before starting a Mobile Operation. Persons



responsible for planning the roadworks are to ensure that appropriate risk assessments are undertaken and that the TMA operators possess the appropriate level of competence and training. All those working on the road must wear high visibility clothing and comply with all of the safety measures identified in the risk assessment at all times.

### 5.3.2 Requirements for multi-lane one-way Level 3 roads

Figure 5.3 shows current New Zealand practice for mobile operations (Transit CoPTTM 2004). This requires the same distances (100–600 m) between work vehicles as in the initial HCH COP (Transit 1997) but the Tail Pilot vehicle is situated on the road shoulder to warn drivers in advance of the lane closure. However, as this practice is not favoured by the roading industry, particularly as it does not appear to protect a work vehicle enough, the original HCH practice (Figure 5.2) is commonly applied. Other differences are mounting signs on the back of a TMA, such as TW-1B (Road works) and TW-34 (Pass with care) with directional left and right arrows.

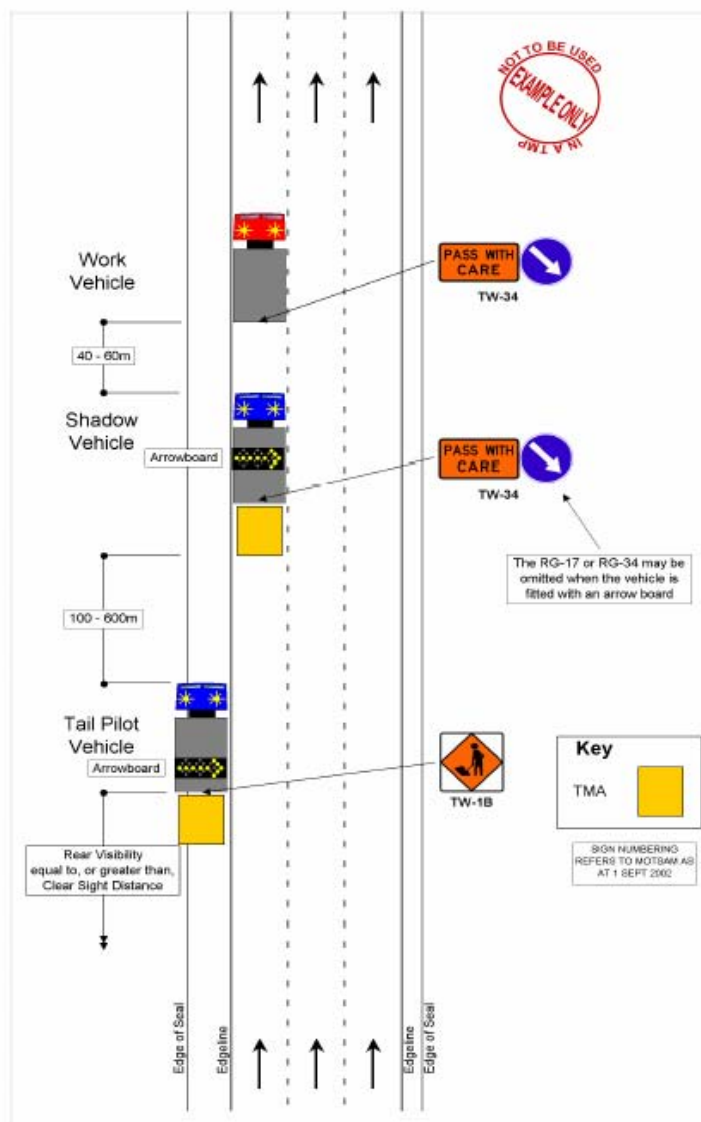

Figure 5.3 Mobile closure for multi-lane one-way Level 3 road. Work vehicle is on the carrieway (Transit CoPTTM 2004).

### 5.3.3 Requirements for two-lane two-way Level 2 roads

The mobile closure presented in Figure 5.4 illustrates the set-up for a two-lane two-way Level 2 road with exposed personnel working on a live lane. The Arrow Board is operating in a Caution Mode (Table 4.1), hence the drivers are required to stop or follow slowly the mobile closure, instead of overtaking the roadwork site. As well, a Lead Pilot vehicle is travelling in front, guiding the operation and warning the oncoming motorists.

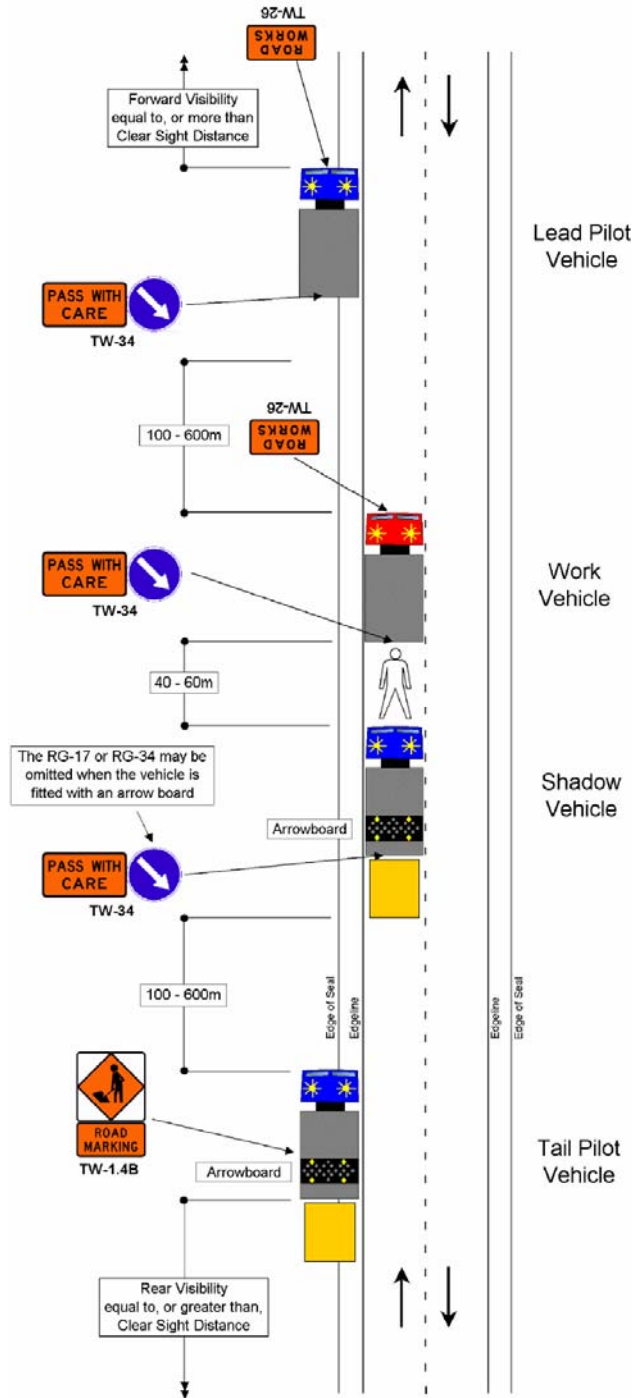

Figure 5.4 Mobile closure for two-lane two-way Level 2 road. Personnel are working in the live lane (Transit CoPTTM 2004).

## 5.4 Summary

A summary of requirements for a mobile closure for Level 3 roads is presented in Table 5.1.

**Table 5.1 Summary of ATM vehicle type and requirements for a mobile closure.**

<b>Vehicle</b>	<b>Requirement</b>
• Tail Pilot Vehicle	Yes
<i>Attenuator</i>	Yes
<i>Arrow Board</i>	Yes
<i>Visibility to rear</i>	<i>300 meters minimum</i>
<i>Distance to shadow vehicle</i>	<i>100-600 metres</i>
• Shadow Vehicle	Yes
<i>Attenuator</i>	Yes
<i>Arrow Board</i>	Yes
<i>Visibility to first working vehicle</i>	<i>50 metres minimum</i>
• Intermediate working vehicles	As necessary
<i>Attenuator</i>	<i>No</i>
<i>Arrow Board</i>	<i>No</i>
<i>Operating flashing lights</i>	<i>No</i>
<i>Distance between vehicles</i>	<i>50 metres</i>
• Leading working vehicle	As necessary
<i>Attenuator</i>	<i>No</i>
<i>Arrow Board</i>	<i>No</i>
<i>Operating flashing lights</i>	Yes

## 6. Review of international TMA practice

International practice provides a good starting point for specification comparison and for new trends in design and usage that are not commonly seen on New Zealand roads. These new TMA configurations have been developed and tested by overseas agencies and may offer significant advantages with respect to driver perception–reaction issues. Countries with in-depth involvement in TMA operations, design and research include the United States of America (US), United Kingdom (UK), Germany and Sweden.

### 6.1 United States

The US has a number of agencies developing and working on road safety, and has high use of TMA. Because of this extensive experience, New Zealand authorities have taken many US regulations as a baseline on which to develop the CoPTTM specifications (Transit 2004).

Therefore US practice, as described in *The Manual on Uniform Traffic Control Devices* (or MUTCD, FHWA 2003), chapters 6F–6I, has requirements in common to New Zealand practice. These similarities are mostly based on the visual requirements for TMA and their usage, though some differences may be significant for road safety issues. Typical US TMA are shown in Figure 6.1.

The MUTCD Arrow Board requirement is similar to CoPTTM (Transit 2004), but additionally American TMA can operate in Flashing Arrow, Sequential Chevron or Flashing Double Arrow (Table 4.1). The minimum mounting height of an Arrow Board should be 2.1 m from the roadway to the bottom of the panel but, if mounted on a vehicle, this should be as high as is practical.

The MUTCD provides guidance for the rotation of flashing beacon lights (between 50–60 rotations per minute), but also allows for equipping TMA with strobe lights instead of rotating lights. Mobile operations take place at night-time, and therefore retroreflective and/or illuminated devices should be used on TMA.

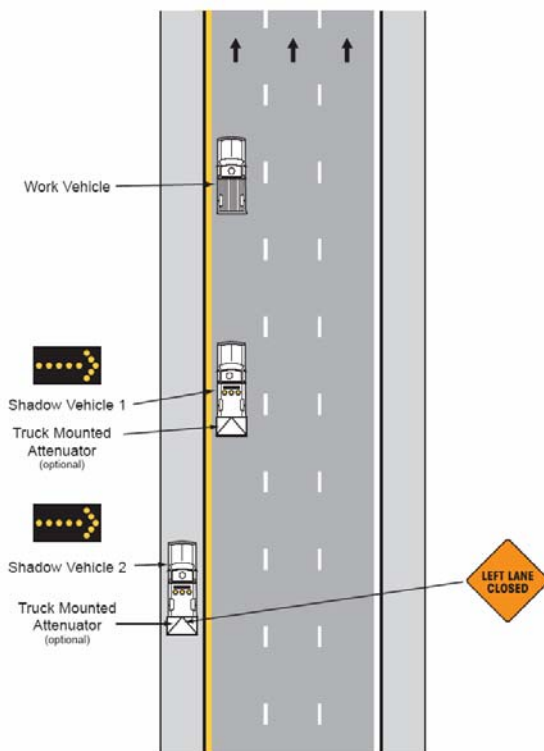

Figure 6.1 Typical TMA used in the US. Appearance when viewed close up (left) and from a distance (right).

The purpose of the Shadow Vehicle 2 (Figure 6.2) (equivalent to Tail Pilot TMA in CoPTTM) is to warn the driver that a work operation is ahead. This vehicle should travel at a distance from Shadow Vehicle 1 so that it will provide adequate sight distance for motor vehicle traffic approaching from the rear.

A 'Left Lane Closed' sign should be mounted (Figure 6.2) at the rear so that it does not cover the Arrow Board. In addition, mounting the Shadow Vehicle 2 with a Crash Cushion is optional.

On high-speed motorways, a supplementary third Shadow Vehicle (not illustrated on Figure 6.2) can be involved, where Shadow Vehicle 1 is operating on the closed live lane, Shadow Vehicle 2 straddling the edge line, and Shadow Vehicle 3 is operating on the shoulder. Mobile closures on Two-Lane Two-Way Roads (Figure 6.3) are less restrictive than CoPTTM (Transit 2004) specifications. Only the Shadow TMA and Working vehicle are engaged in the operation, and no Tail Pilot TMA or Lead Pilot vehicle is required.



**Figure 6.2** Mobile closure on a multi-lane one-way road as used in the US (FHWA 2003).

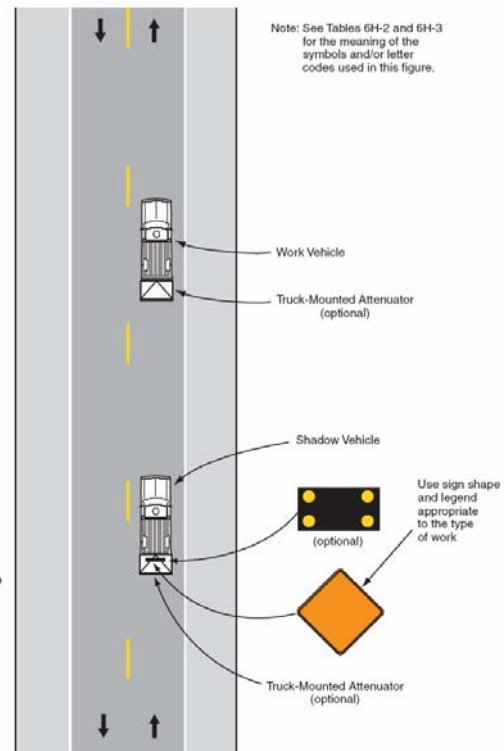

**Figure 6.3** Mobile closure on a two-lane two-way road as used in the US (FHWA 2003).

MUTCD strongly suggests that reduced speed limits should be allowed in the roadwork site only where conditions or restrictive features are in use, and that frequent changes in the speed limit should be avoided. Further it advises that "Reduced speed zoning (lowering the regulatory speed limit) should be avoided as much as practical because drivers will reduce their speeds only if they clearly perceive a need to do so".

Additionally MUTCD suggests that, based on research, large speed reductions of 30 mph (50 km/h) increase variations in speed between vehicles, thereby increasing the potential for car crashes. Hence a speed reduction of no more than 10 mph (16 km/h) is justified. If this cannot be achieved then additional notification should be provided to the road users.

Guidelines for Shadow TMA use in a range of mobile and short-term applications, developed by Humphreys (1991, cited in Kamyab 2002), and which has possibly shaped MUTCD (2003), are shown in Tables 6.1 and 6.2. The study “very highly” recommends the use of Shadow TMA on both freeway and non-freeway operations if personnel are exposed and no warning is set up in advance.

**Table 6.1 Recommendations for the assignment of Shadow Vehicles (Humphreys 1991, in Kamyab 2002).**

Closure/Exposure condition	Freeway	Non-freeway with speed limit		
		>=50 mph	40-45 mph	< +35 mph
Shadow vehicle for no formal lane closure for operation involving exposed personnel	Very highly recommended	Very highly recommended	Very highly recommended	Very highly recommended
Shadow vehicle for no formal lane closure for operation <b>NOT</b> involving exposed personnel	May be justified*	May be justified*	May be justified*	May be justified*
Shadow vehicle for no formal shoulder closure for operation involving exposed personnel	Highly recommended	Highly recommended	Recommended	Recommended
Shadow vehicle for no formal shoulder closure for operation <b>NOT</b> involving exposed personnel	May be justified*	May be justified*	May be justified*	May be justified*

- May be justified on the basis of special conditions encountered on an individual project

**Table 6.2 Recommendations for the application of TMA (Humphreys 1991, in Kamyab 2002).**

Closure/Exposure condition	Freeway	Non-freeway with speed limit		
		>=50 mph	40-45 mph	< +35 mph
Shadow vehicle for no formal lane closure for operation involving exposed personnel	Very highly recommended	Highly recommended	Recommended	Desirable
Shadow vehicle for no formal lane closure for operation <b>NOT</b> involving exposed personnel	Highly recommended	Highly recommended	Recommended	Desirable
Shadow vehicle for no formal shoulder closure for operation involving exposed personnel	Highly recommended	Recommended	Recommended	Recommended
Shadow vehicle for no formal shoulder closure for operation <b>NOT</b> involving exposed personnel	May be justified*	Recommended	Desirable	May be justified*

- \* May be justified on the basis of special conditions encountered on an individual project

A comparison of New Zealand practice with the equivalent US practice is justified given the higher incident rate recorded in New Zealand. However, other aspects of road safety issues that are being put into practice in the US have probably lowered the rate of incidents there. These include:

- Encouraging public awareness campaigns for traffic management, e.g. "Slow for the cone zone", based on social awareness whereby the individual makes the conscious decision based on social responsibility, rather than scare tactics.
- Every worksite has trailer-mounted, vehicle-mounted or fixed, variable message signs and Arrow Boards to provide advance warning to the motorist. This is an obligatory MUTCD requirement.
- More emphasis seems to be placed on the motorists to take care, by applying double the road infringement fines for incidents in construction sites, and heavy policing of work sites.

In New Zealand, a campaign designed by LTSA and Roothing New Zealand to promote driving with consideration and care through roadwork sites is scheduled to be implemented in years 2004–2005. The aim of this campaign combining advertising, education and public relations, is to raise awareness of the problem and encourage motorists to slow down and keep to the posted speed limit at roadwork sites (NZAA 2005). The level of road safety on New Zealand roads may improve with this campaign but to achieve the US level of road safety may take several years to attain.

## **6.2 United Kingdom**

The UK road safety strategy is very comprehensive, and covers several priority themes for road safety, with a host of specific measures, together with an implementation plan for many specific recommendations. Nevertheless it is not intended to be a rigid blueprint.

The UK Design Manual for Roads and Bridges (UK Highways Agency 2003) is an extensive publication on designing and working on roads and bridges. TMA operations are referred to in its Volume 8, Section 4, Part 4: *The mobile lane closure technique for use on motorways and other dual carriageway roads*.

The uniform visual appearance of TMA is comprehensively defined, as shown in the technical drawings of the message board in Figure 6.3; and no changes or experimental VES are to be implemented by the roading industry.

The message board, of size 2.5 m x 2.5 m but preferably 2.3 m x 3.0 m, is bright yellow (Figures 6.4 and 6.5).

The first advance warning vehicle sign is mounted with a lane closure diagram whereas TMA operating on the live lane may be mounted with a 'keep right/left' arrow sign of 1.5 m diameter. The pointing direction of the arrow (Figure 6.4) is controlled from the driver's cabin.

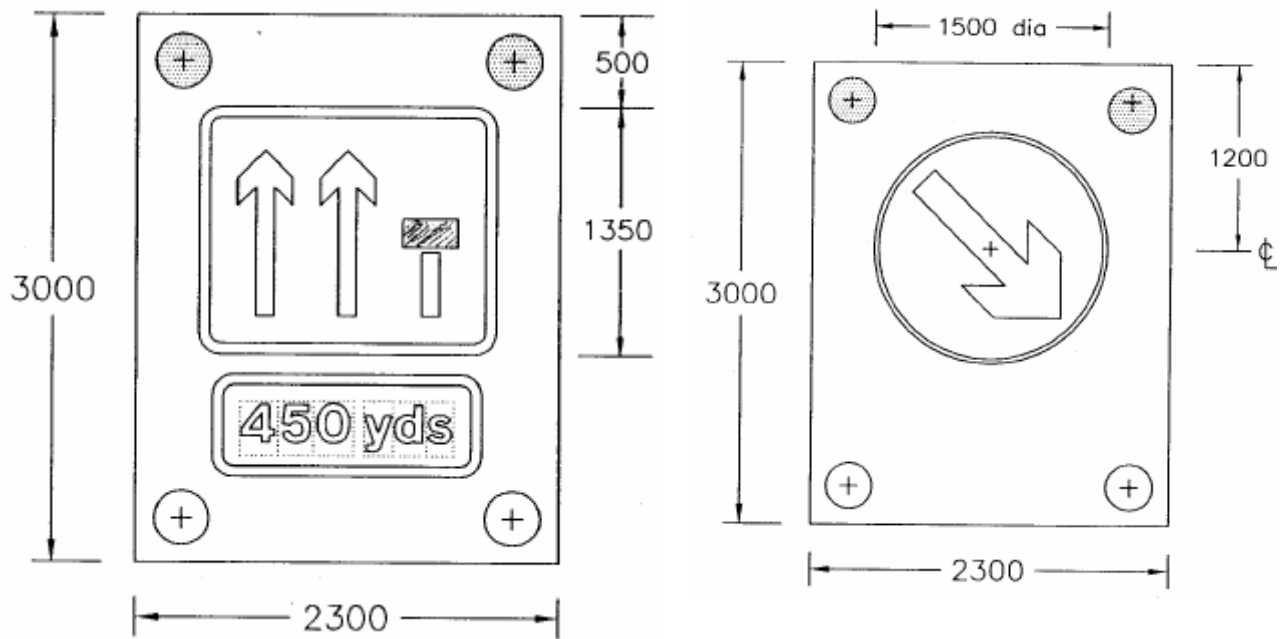

Figure 6.4 Technical drawing of message board (UK Highways Agency 2003).

On each corner of the backing board a flashing amber lamp is mounted. Each lamp of diameter 300 mm  $\pm$ 10 mm must show an alternating amber light at a rate between 60 and 90 flashes per minute (preferably 60–70), so that the lights of one horizontal pair are always flashing when the lights of the other horizontal pair are not. The intensity of these lights must be reduced by 60%–80% at night to avoid dazzling motorists.

All TMA should be fitted with at least one rotating amber beacon which can be seen for 360°, and is used when in operation, but it should not be operated when the four flashing amber lamps are used.



Figure 6.5 Standard TMA used in the UK, the arrow board of which can be changed (from the driver's cabin) to show different directions.



A higher visibility alternative (Figure 6.6) to the sign presented in Figures 6.4 and 6.5 is recommended for use in more risky operations where, for instance, the visibility is reduced by night conditions or in heavy traffic volumes. In this situation, a sign, which incorporates a flashing light arrow (Table 4.3) should supplement the message given by the 'keep left/right' sign but it must not be operated in flashing arrow mode when the TMA is used on the hard shoulder.



**Figure 6.6** TMA with Skew Arrow Board, used in the UK for risky operations at night or in heavy traffic.

The requirements for management plans for mobile operations are very rigorous in terms of safety, especially when including personnel on foot who are exposed to motorway traffic. This work set-up requires at least four TMA engaged in the operation to block a working space from the traffic (Figure 6.7). This includes one TMA positioned on the shoulder, and then the following TMA positioned on the live lanes with 50 m distances between them. However, this arrangement requires at least one open lane to keep the traffic flowing and a hard shoulder must be available. When these requirements are not available, the operation should be undertaken as shown on Figure 6.8, where three trucks are used as advance warning but are not required to have crash cushion attached.

For both situations the intervals between advance warnings and TMA can be changed to concentrate the warning information presented to passing drivers who can then see, at any instant, at least two consecutive signs.

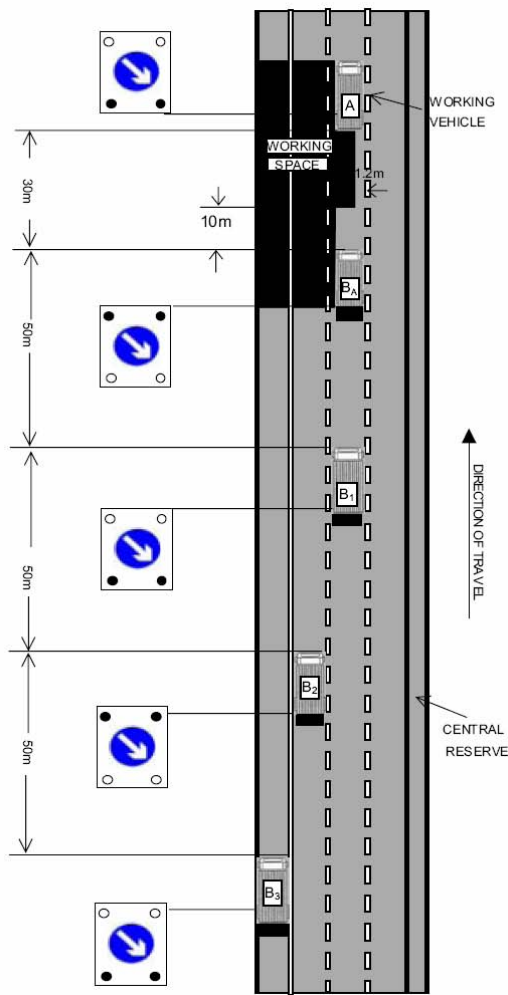

Figure 6.7 Layout for left-lane closure, dual two-lane, all purpose road, with hard shoulder. Personnel are working on foot.

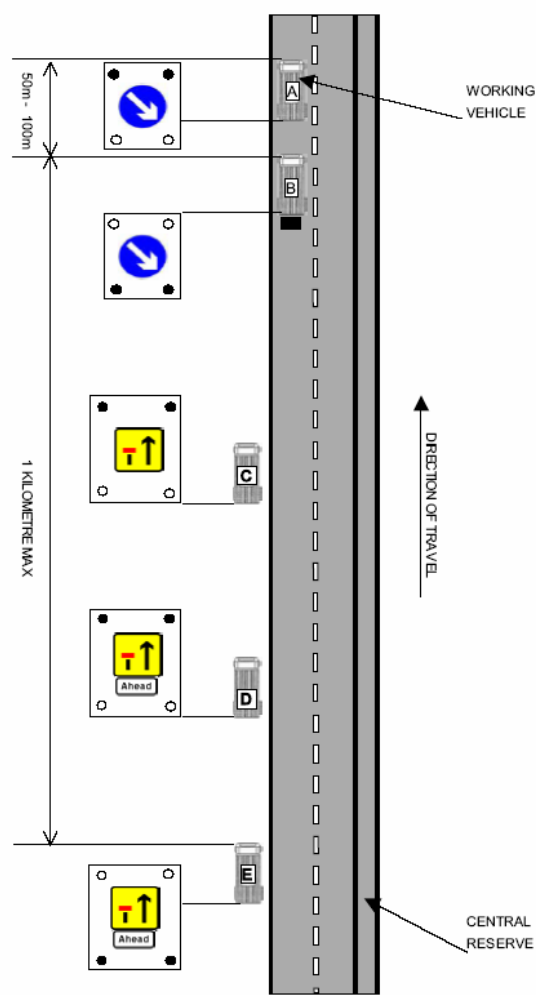

Figure 6.8 Layout for left-lane closure, dual two-lane, all purpose road, without hard shoulder (UK Highways Agency 2003).

### 6.3 Sweden

In 1997, Sweden's parliament adopted 'Vision Zero', a bold new road safety policy to be a central theme in their vision for road safety. Vision Zero can be described as follows:

*Nobody should be killed or seriously injured within the road transport system.  
The road transport systems' structure and function should be brought into line with the demands that this goal entails.*

The long-term goal of the total eradication of the number of deaths and serious injuries suggests that the way forward is to stop blaming the incorrect behaviour of road users, and to realise that people do make mistakes. Instead the idea is to design the transport system, in terms of safety, to allow for such mistakes.

The Swedish National Road and Transport Research Institute (VTI), a part of the Swedish Department of Transportation, is responsible for shaping developing practice on TMA use (see Vägverket 2003). The Swedish requirements for the visual message board practice (Figure 6.9) present a similar pattern to the UK example but with some differences.

Shadow TMA are always required to have a large arrow board with a skew arrow mounted, and two built-in LED lights mounted on the top corners of the board pointing towards the oncoming traffic. Underneath the arrow board, a mounted large-sized directional arrow (RG17/34) of 1 m minimum diameter, controlled from the driver's cabin, points the same direction as the flashing arrow. Two horizontal retroreflective strips are attached above and below the arrow to increase the visibility of the TMA at night. The message arrow board is 2.2 m wide and the height ranges between 3.9 and 4.8 m.

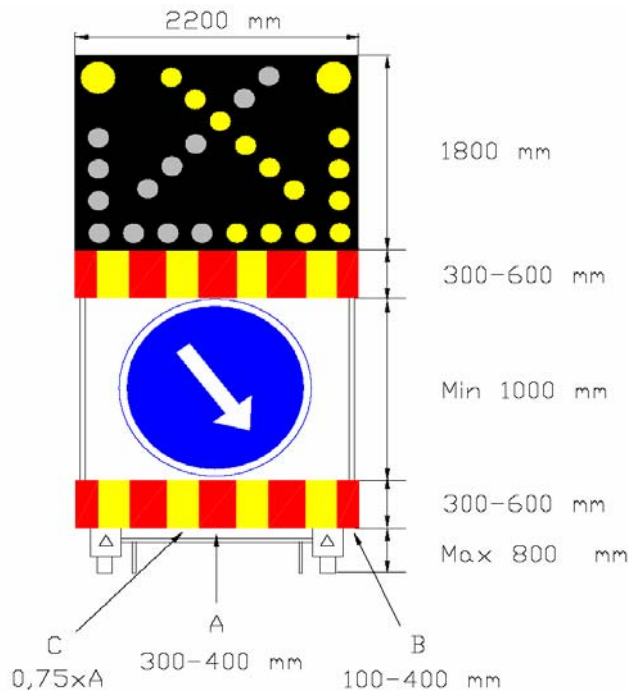

Figure 6.9 Shadow TMA used in Sweden.

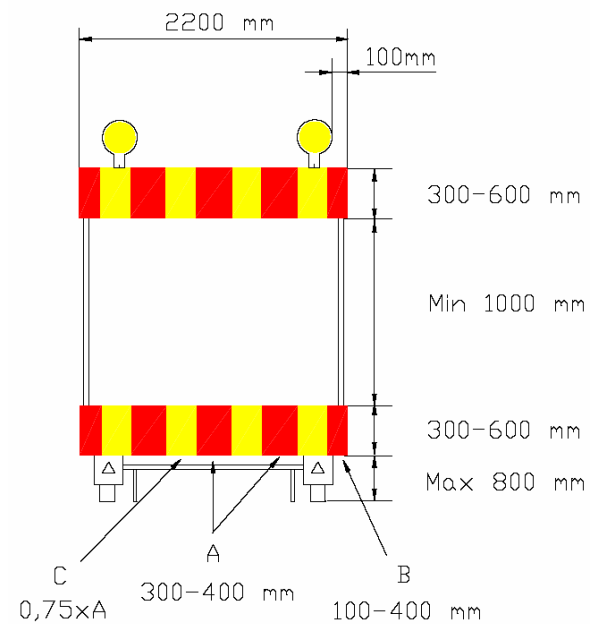

Figure 6.10 Tail Pilot TMA used in Sweden.

The Tail Pilot TMA (Figure 6.10), in contrast to the Shadow TMA, has the arrow board and directional arrow (RG 17/34) sign dismantled and an image of a 'Lane closed XXX meters' sign is attached instead, with two flashing LED/strobe lamps to seize the attention of drivers. The width of the message arrow board is 2.2 m, and its height ranges between 2.1-3.0 m.

Both Shadow and Tail Pilot TMA have two horizontal retroreflective strips to increase the visibility of the TMA at night, and a 'Men working' sign attached on the top of Tail Pilot TMA. For the Shadow TMA the sign is mounted next to the arrow (RG-17/34) sign (Figure 6.11).

The Shadow TMA is positioned close to the live lane. This position provides better protection to the road workers by preventing other road users from entering the 1-m Safety Zone. Another advantage of this position is it may cause a decrease in traffic speed because the available road space is narrowed. On a two-way two-lane motorway, the Tail Pilot TMA, depending on the nature of roadwork operations, is stationed or moving on the shoulder at 400 m behind the Shadow TMA (Figure 6.11).

However, on a two-way three-lane motorway, a fast-lane closure needs the additional action of positioning a second Shadow TMA on the middle lane. This precautionary step blocks errant vehicles from entering a roadwork site and directs the traffic to the last lane available. However this also slows traffic significantly.

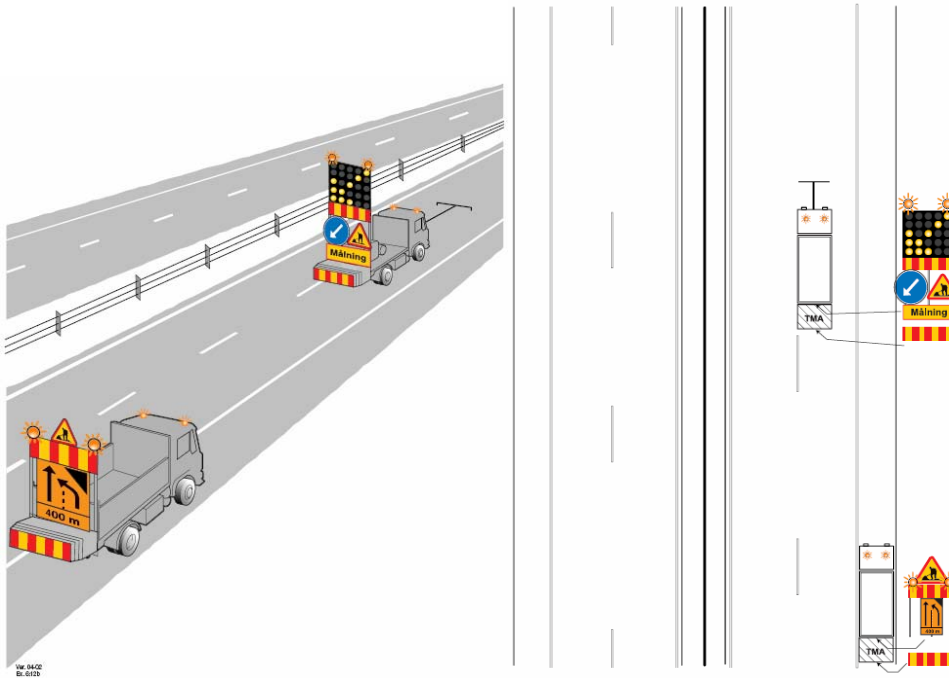

Figure 6.11 The TMA set-up of a Swedish mobile operation.

## 6.4 Germany

German Federal road safety policy is derived from an overall view on the social dimension of mobility and safety. Technical publications produced by the Bundesminister für Verkehr (1991, 1997) and Schonborn/Schulte (1995, 1997) specify the German TMA practice for roadwork sites.

The German requirements for the visual message board practice (Figure 6.12) present a similar pattern to the UK and Swedish examples, but with some minor differences. All edges of the Message Board are covered with 500 mm-wide retroreflective tape.

The total height of the message board is 3.6 m, which means it is the shortest one compared to Swedish or UK TMAs, but its 2.2 m width is the same, as are the size and type of arrow, strobe light, and mounted RG-17/34 arrow sign. The flashing frequencies of the lights are  $40 \pm 5$  per minute, and their intensity for night work is reduced by 55% of maximum power.

When a TMA is operating on local roads, such as Level 1 and 2 roads, a smaller version of the message board can be used (Figure 6.13). Overall, width (1.7 m) and height (2.5 m) is reduced, as well as size of arrow panel and RG-17/34 sign, but the diameter of the strobe light stays the same (300 mm).

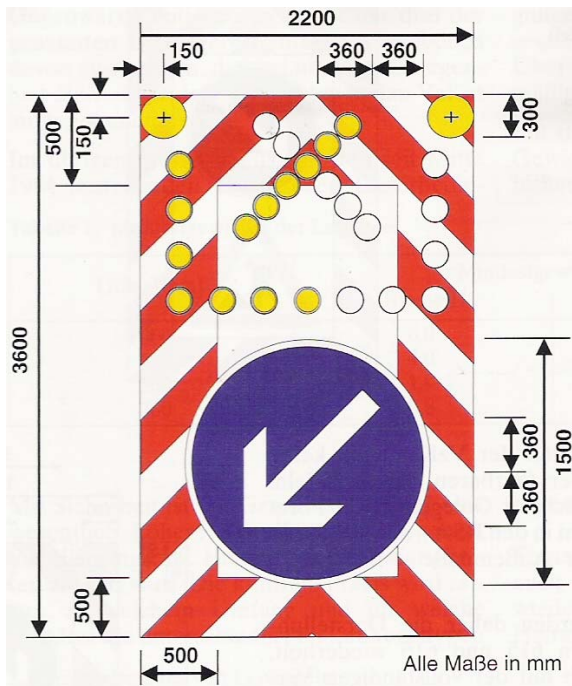

**Figure 6.12** TMA used for motorways in Germany.

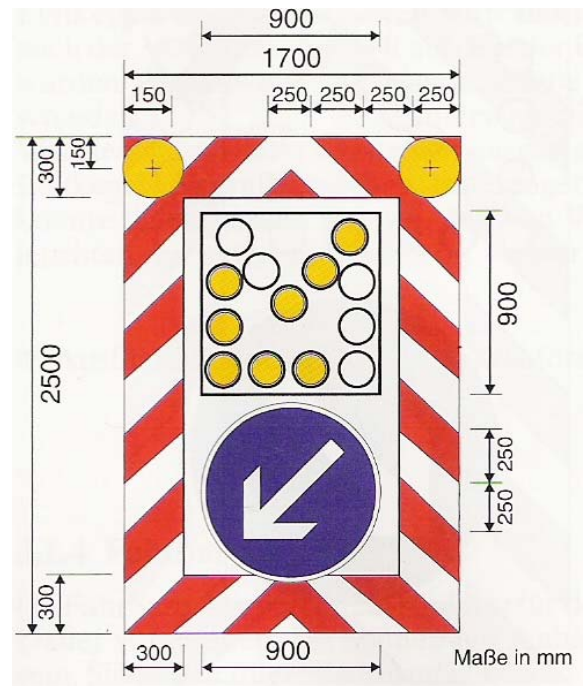

**Figure 6.13** TMA used for local roads in Germany.

The requirements for management plans of mobile operations depend on visibility and speed limit, and three scenarios are specified. They all require a Shadow TMA to be positioned 50 m behind the working vehicle with cones between them. The differences between the scenarios depend most on visibility:

- Scenario 1 – if visibility is more than 800 m, and speed limit less or equal to 120 km/h, no advance warning is obligatory.
- Scenario 2 – if visibility is between less than 800 m but more than 400 m, two advance warnings are required (as presented on Figure 6.14). The first advance warning can be changed to Skewed Arrow Panel (Figure 6.15) if the proposed component is not available.
- Scenario 3 – if visibility is less than 400 m, additional warning (see Figure 6.15) at 1000–1400 m is required in advance of the Shadow TMA.

As German motorways often have unlimited speed limits, the temporary speed limit is reduced to 100 km/h as covered by scenarios 2 and 3.

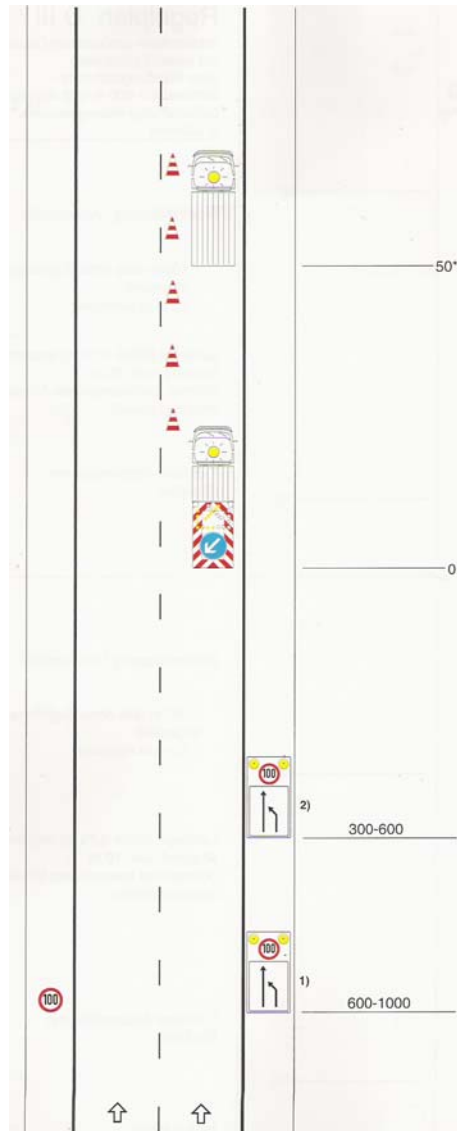

Figure 6.14 Layout for right lane closure on a German motorway if visibility is between less than 800 m but more than 400 m, as for Scenario 2.



Figure 6.15 Advance warning with skewed arrow panel used on a German road if visibility is less than 400 m, as for Scenario 3.

## **6.5 Summary**

Designing safe temporary traffic management plans for lane closures in which TMA are participating is dependent on several issues but especially on visual aspects related to driving activity.

The physiological capabilities of a driver that affect individual performance have been taken into consideration by roading equipment manufacturers, and by New Zealand transportation authorities in management of roadwork sites.

Combining knowledge of human physiological characteristics and adjusting available technology to improve the perception–reaction time of a vehicle driver, extends their competence to enable them to cope with driving in traffic.

Understanding these fundamental facts, which all roading industry working groups consider, should result in the most efficient procedure for mobile operations on the roadwork site. However, these facts are interpreted in a variety of ways in different countries. The differences are influenced by the experience, training, driver education and that country's approach towards the level of safety at roadwork sites.

Some countries, such as Germany and the UK, have extra enforcement at mobile operations by providing two or more advance warnings positioned before the shadow TMA, whereas others believe that one advance warning is sufficient.

New Zealand practice, which is to some extent modified for the local environment, is mainly based on US knowledge and experience on the visual outlook of TMA and their use, and requires mounting rotating lights and a horizontal arrow panel. On the other hand, European countries have introduced new designs for TMA, such as skewed arrow panels and strobe lights, and strongly support their superiority over other technology available at present.

## **7. Methodology for TMA studies**

### **7.1 Introduction**

This chapter focuses on the methodology adopted for the two studies undertaken on use and design of TMA, both of which were carried out during day and night under clear weather conditions. Study 1 applied eight different TMA configurations, and it served as the baseline for Study 2 for which six different TMA configurations were applied and trialled.

The driver's response, or 'recognition distance' (RD), was measured and used to evaluate the visual performance of each TMA during day and night operations. This measure (of the driver's RD) was taken from the point where the driver changed lane, or indicated that they would change lane. The assumption was that the driver's response is related to the visual outlook of the TMA. The data obtained were stored and subsequently analysed for statistical differences in drivers' responses between different VES arrangements on the TMA.

Both studies took place under actual driving conditions on the Southern Motorway, State Highway 1 (SH1), Auckland. Study 1 was undertaken on the Motorway between Otahuhu and East Tamaki (Location 1), and Study 2 near Takanini (Location 2). The interaction of driver and driving situation under real-time TMA operations reveals the deficiencies and strengths of each TMA set-up. This approach not only abandons the common idea that human errors cause crashes with TMA but also identifies factors that are incompatible between drivers and the traffic control devices (Fuller 2002). Studying a real-time TMA activity gives a picture taken from real traffic such as dynamics, interactions with infrastructure, traffic interference. This preserves the essential and realistic dimension of driving situations. Obtaining accurate information of drivers' behaviour around TMA operations will provide a strong picture of the interrelations between driver and different VES components mounted on the TMA.

### **7.2 Study 1: Trial of existing TMA set-ups**

#### **7.2.1 Overview**

The experimental set-up for Study 1 focused on the performance of the TMA most commonly used by the industry working group and required running 14 trials, seven of which were during the day and seven at night. The experiment took place from 16<sup>th</sup> November to 2<sup>nd</sup> December 2004, from Mondays to Thursdays as these weekdays each carry the same traffic hourly pattern and volumes (Lay 1986). As the operation of TMA is limited to off-peak hours (Transit 2004) the trials were run at 10.00 am (10.00 hours day) and 9.30 pm (21.30 hours night) for 15 minutes each, and under clear weather conditions because the operation of TMA is limited to favourable weather conditions (according to Transit's CoPTTM, 2004).



All trials were mobile closures, without any cone tapers and pre-warning, and hence the driver's response was dependent only on the appearance of the TMA.

### 7.2.2 Location 1, Otahuhu–East Tamaki Southern Motorway

The location of Study 1 was the Southern Motorway, SH 1, between Otahuhu and East Tamaki (Figure 7.1), Auckland. SH1 is a major arterial road for the Auckland region accounting for just over 200 000 annual average daily traffic (AADT) (Transit 2003). The section of the motorway chosen for the study design is two-way six-lane with a speed limit of 100 km/h (Figure 7.2). No off-ramps or on-ramps were in the trialed part of the motorway, and so the traffic flow was not affected by such external influences.

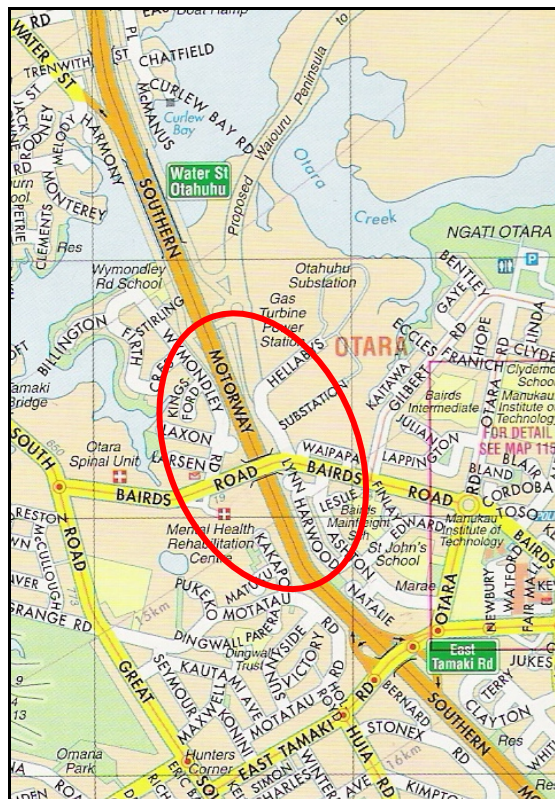

Figure 7.1<sup>6</sup> Location 1 of Study 1.

The trial involved closing the left lane for northbound traffic heading towards Auckland City (Figure 7.2). A primary factor for selecting the left lane was that it had a higher traffic volume than other lanes, and therefore a larger size sample was obtained in a shorter time, which led to more robust results.

The Shadow TMA was parked 410 m from the Bairds Road over-bridge (Figure 7.3). This shadow TMA was visible from the horizontal curve at a distance of approximately 800–850 m if other vehicles did not block visibility. In front of the Shadow TMA a second TMA was positioned (which is the most common practice used in the industry). This front TMA was fully screened by the Shadow TMA which was therefore the only TMA visible to the approaching vehicles (Figure 7.3).

<sup>6</sup> Auckland, Hamilton & 28 Regional Towns. Compact Street Directory (KIWI Minimap 2003)



Figure 7.2 Northbound lanes on Location 1 on the Southern Motorway, Auckland.

The apparatus for recording driver behaviour was located on the Bairds Road over-bridge above the motorway.

### 7.2.3 Trial of existing TMA at Location 1

The VES mounted on the TMA that were trialled included those most commonly used on the New Zealand road network and were provided by the industry working group. Of these four TMA, three of them were equipped with a horizontal arrow panel (Table 4.1, Section 4.2.1) and one was mounted with a Variable Message sign. In total, eight different VES were tested, ranging from the type of message displayed to use of warning lights. Each TMA was identified by number as Trucks 1 to 8. The VES configurations of these eight TMA set-ups are presented in Table 7.1.

The trialled set-ups included all the VES used by the industry and which comply with the CoPTTM regulations (Transit 2004), namely Trucks 1, 4, 5 and 8. The others are new VES configurations which required little or no cost modifications to change the existing TMA. These included activating the halogen lamps or changing the arrow panel display and were identified as Trucks 2, 3, 6, 7.

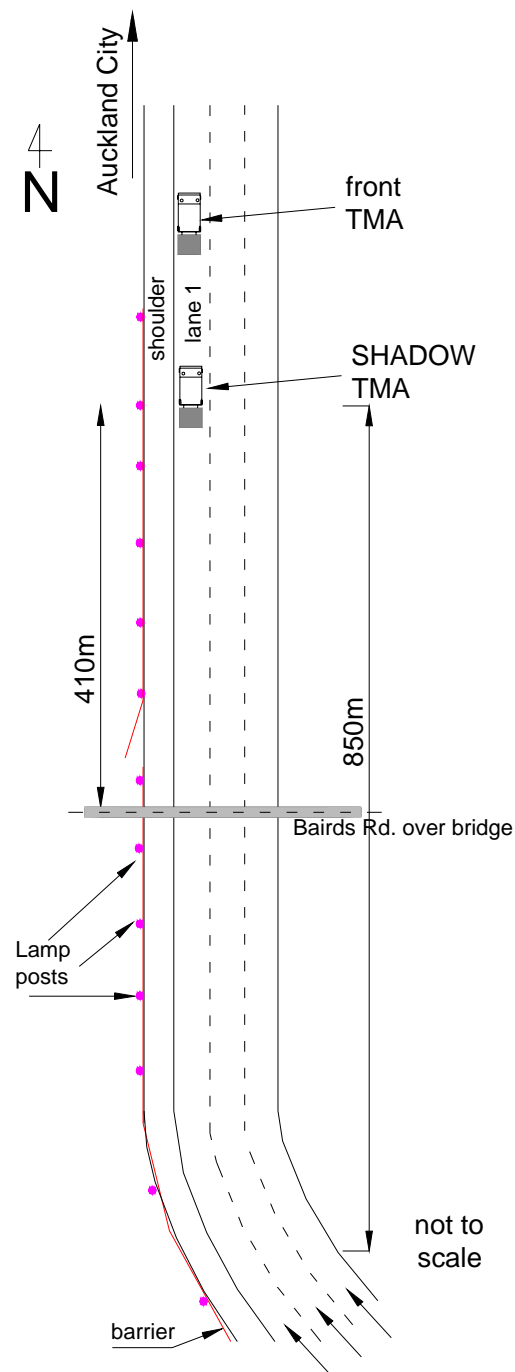

Figure 7.3 Layout of TMA at Location 1 for Study 1, on the Southern Motorway.

Table 7.1 The eight TMA trialled for Study 1 at Location 1.







TMA type	VES configuration type
<p>Fulton Hogan</p>  <p>*TW-26 and TW-20A dismantled</p>	<p><b>Truck 1</b> – All beacons on, arrow board operating*</p>  <p><b>Truck 2</b> – All beacons off, arrow board operating</p> <p><b>Truck 3</b> – All beacons on, arrow board operating in chevron mode</p> 
<p>Fulton Hogan</p> 	<p><b>Truck 4</b> – All beacons on, Variable Message Sign operating (night trial only)</p>
<p>Higgins Contractors</p> 	<p><b>Truck 5</b> – All beacons on, arrow board operating</p> <p><b>Truck 6</b> – All beacons on, arrow board operating, halogen lights on (day trial only)</p> <p><b>Truck 7</b> – Front beacon on, rear beacon off, arrow board operating, halogen/LED lights operating on the corners of arrow board (night trial only)</p>

Table 7.1: continued

<p>Works Infrastructure</p>  <p>*TW-01 sign dismantled</p>	<p><b>Truck 8</b> – All beacons on, arrow board operating, no retroreflective tape on the message board</p>
---	---

Mounting the obligatory static signs under the arrow panel, which is required by CoPTTM (Transit 2004), was omitted to minimise the confusing visual outlook of TMA. This is also in accordance with European practices. The other aim of this 'minimalist approach' was to reduce the drivers' perception time (Roess 2004; Ogden & Bennett 1996), which, as it depends on identification and reading time before the response is implemented, drivers should responded quicker, and perception time should be shorter. Additionally, contrasting the arrow panel against its surroundings was improved by dismantling the signs as this resulted in an uncluttered background (Helmets et al. 2004; Kuhn 1997).

### 7.3 Study 2: Trial of existing and improved TMA set-ups

#### 7.3.1 Overview

The experimental set-up for Study 2 at Location 2 on the Southern Motorway compared the performance of the six best TMA from Study 1 and a newly designed TMA. This required running six TMA trials, three of which were at day and three at night. The experiments took place from 24<sup>th</sup>–26<sup>th</sup> May 2005, from Monday to Wednesday, for the same reasons as outlined in Study 1 (see Section 7.2). The trials were run at 10.00 am (1000h) (day) and 9.45 pm (2145h) (night) for 15 minutes each. The traffic volumes at this time for the Left lane were similar those recorded for Study 1. All trials consisted of mobile closures and were run under clear weather conditions as for Study 1.

Initially, the newly designed TMA, which required shipping new elements from Germany, was scheduled to be trialled at Location 1. However, establishment of a construction site adjacent to the motorway shown in Figure 7.4, which incorporated a long-term shoulder closure with an advance warning set-up, prompted the establishment of a new trial location, called for convenience Location 2. Consequently, the trials with new equipment were run together with trials of the best performing TMA from Study 1 at this Location 2.



Figure 7.4 Location 1 showing the shoulder closure on the motorway which necessitated a change of trial site to Location 2 for Study 2.

### 7.3.2 Location 2, Takanini, Southern Motorway

The location for the Study 2 trial was the Southern Motorway, SH1, in the area of Takanini (Figure 7.5) on the southern outskirts of Auckland. The section of the motorway chosen for the experimental design is a two-way four-lane road (Figure 7.6), and its speed limit is 100 km/h. Neither off-ramps nor on-ramps were in the trialled part of the motorway, hence the traffic flow was not affected by such external influences.

The trial involved closing the left lane for southbound traffic heading from Auckland City to Papakura (Figure 7.7) because it had higher traffic volumes, as for Study 1. The Shadow TMA was parked 200 m from the Walter Strevens Drive overbridge (Figure 7.7). The TMA was visible from the horizontal curve distance which gave approximately 600–650 m if visibility was not impaired by other vehicles.

A second TMA was positioned in front of the Shadow TMA, as this is the most common practice used by the industry working group. Only the Shadow TMA was visible to the approaching vehicles as it fully screened the front TMA.

The apparatus for recording driver behaviour was located on the Walter Strevens Drive overbridge crossing the motorway.

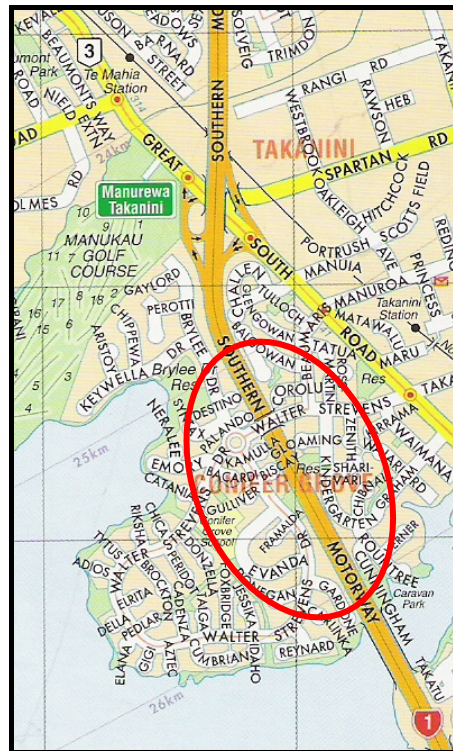

Figure 7.5 Location 2 of Study 2.



Figure 7.6 Southbound lanes at Location 2 on Southern Motorway, Auckland.

<sup>7</sup> Auckland, Hamilton & 28 Regional Towns. Compact Street Directory (KIWI Minimap, 2003)

Two of the trials for both day and night involved a TMA set-up running with the two types of advance warning. The differences between the two relate to the message displayed.

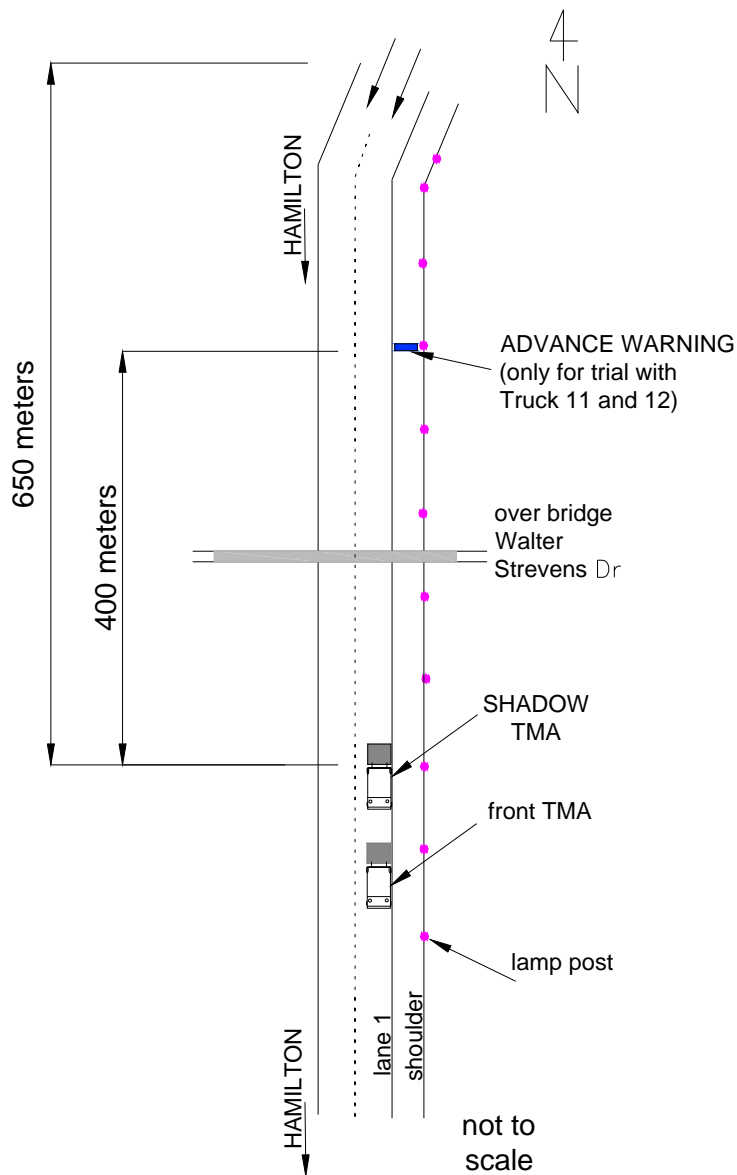

Figure 7.7 Layout of TMA at Location 2 for Study 2, on the Southern Motorway.

The advance warning was located on the shoulder 400 m before the Shadow TMA (Figure 7.7). The choice of advance warning location was based on two findings.

The first finding was related to Swedish TMA practice (detailed in Section 6.3), which requires the positioning of one advance warning message before the mobile lane closure. Vägverket (2003) suggests positioning the advance warning 400 m before the TMA.

The second finding was related to traffic engineering practice evaluated by Ogden (1996). On the basis of his research he concluded that short-term memory has a very limited



capacity, and memory fades after about 30 seconds. For longitudinal placement of signs Ogden suggests that the advance distance for a suitable sign site should not be more than 10 to 15 seconds of travel ahead of the hazard or decision point so that the earlier message is not forgotten.

At the speed limit of the trialled location of Study 2, 10–15 seconds equates to 280–420 m. Based on these published findings, the 400 m value was considered appropriate. The advance warning was visible from the horizontal curve distance of approximately 250 m if visibility was not impaired by other vehicles.

### **7.3.3 Trial of TMA at Location 2**

The TMA trialled for Study 2 included 'the best' TMA evaluated from Study 1 and new TMA set-ups, including a German-designed TMA (see Section 6.4) imported for the purpose of this research. As well as the TMA itself, trialling other parts comprising a TMA set-up were included.

These included an advance warning sign positioned on the shoulder 400 m before the Shadow TMA. In total, six different VES (Visual Enhancement Systems) on the TMA were tested, some during both night and day, and these configurations are presented in Table 7.2. The VES configuration set-ups for each TMA were identified as Trucks 1, 6, 9, 10, 11, and 12 for this Study 2. Trucks 1 and 6 were the same as Trucks 1 and 6 from Study 1, whereas the TMA on Trucks 9, 10, 11, 12 were new set-ups.

## **7.4 Data collection and analysis**

The drivers' responses were recorded with video equipment. The recognition distance was detected when the driver changed lane. This response was referred to as the "nearest skipping/changing lane". Distance of this point to the TMA was known from the road layout and features that are detailed in Figures 7.3 and 7.7. The distances were rounded to the nearest 10 m.

Data for Studies 1 and 2 were stored in four data files, two for each study, one for day and one for night. The obtained data were stored and analysed to evaluate the traffic behaviour under each of the different TMA arrangements. An analysis of variance (ANOVA) was performed to determine whether significant differences existed among the different VES in terms of the dependent variable. These comparisons were made as a function of different VES, describing the relationship between perception–reaction times and VES mounted on the trucks for night or day for each study. The key result of these investigations was to provide the industry with recommendations for the 'most effective' visual appearance of TMA. Thus the earlier the driver response, the more 'effective' the VES set-up for TMA was considered to be.

Table 7.2 The six TMA trialled for Study 2 at Location 2.









TMA type	VES type
<p>From Study 1: Fulton Hogan</p>  <p>*TW-26 and TW-20A dismantled</p>	<p><b>Truck 1</b> – All beacons on, arrow board operating* (night trial only)</p> 
<p>From Study 1: Higgins Contractors</p> 	<p><b>Truck 6</b> – All beacons on, arrow board operating, halogen lights on (day trial only)</p>
<p>New: Fulton Hogan</p>  <p>*TW-26 and TW-20A dismantled</p>	<p><b>Truck 9</b> – All beacons off, strobes on (mounted in the middle), arrow board operating (night trial only)</p>

Table 7.2: continued

<p>New TMA</p> 	<p><b>Truck 10</b> – All beacons off, strobes on, arrow board operating</p>
<p>New TMA (as Truck 9) + advance warning A</p> <div style="display: flex; justify-content: space-around;">   </div> <p>1<sup>st</sup> sequence                      2<sup>nd</sup> sequence</p>	<p><b>Truck 11</b> – (as Truck 10) + advance warning*</p> <p>* strobes on and message displayed sequentially by diagram and wordy message below: (1) LEFT LANE (2) CLOSED</p>
<p>New TMA (as Truck 9) + advance warning B</p> <div style="display: flex; justify-content: space-around;">   </div> <p>1<sup>st</sup> sequence                      2<sup>nd</sup> sequence</p>	<p><b>Truck 12</b> – (as Truck 10) + advance warning**</p> <p>** strobes on and wordy messages displayed sequentially: (1) PLEASE MERGE 400 m (2) LEFT LANE CLOSED 400 m</p>

Study 1 and the overseas research (Chapter 6), provided the baseline for Study 2 and played a major role in choosing the new TMA practice and associated operational procedures. The results from Study 1 enabled development of the best set-up, in terms of low cost improvements to the presently existing TMA, that would adequately warn drivers of the hazard that a TMA creates on a live lane. The best performing TMA were run in Study 2 together with the new TMA practice, including adjustments to the visual appearance of the message board and the use of advance warning as used overseas. The data recorded while running the new TMA set-ups and the 'best' Study 1 set-ups were compared, and the effectiveness of the modifications were evaluated.

## **7.5 Problems encountered**

### **7.5.1 Study 1 problems**

Under day conditions, while evaluating Truck 4, traffic flow during the trials led to local traffic congestion, possibly because this set-up was inefficient. This situation provided unusable data, because the vehicles travelled at a speed much below the normal operating speed, and the trial was cancelled.

Under day conditions, local traffic congestion lasting 4 minutes occurred with Truck 8, which resulted in the vehicles travelling at speeds much below the normal operating speed. After that time the traffic congestion was cleared and the trial continued without disturbance. Consequently, the 4-minute congested period was not taken into consideration.

Truck 7 was planned to be trialled through both day and night. However, it was unintentionally trialled with all beacon lights on during the day. This unplanned set-up was termed Truck 6, and a day trial with Truck 7 was not completed.

Under day conditions, Truck 2 which was operating without the rotating beacon lights, was trialled for only 10 minutes for safety reasons. The risk of crash was extremely high because drivers did not recognise the lane closure indicated by Truck 2.

Under night conditions, Truck 8 was trialled for only 8 minutes (size sample  $N = 40 > 30$  minimum, according to Condra (2001) and Diamond (2001)). After the 8<sup>th</sup> minute, another mobile operation from a different contractor entered the study part of motorway, and the trial had to be stopped.

Deploying the video equipment and cameras on the bridge covered the study part of the motorway. However, the invisible area underneath the bridge 400–420 m from the parked TMA required dividing the results in this area into three equal values for 400, 410, and 420 m.

### **7.5.2 Study 2 problems**

Under day conditions, Truck 6 was trialled for only 10 minutes (size sample  $N = 102 > 30$  minimum, according to Condra (2001) and Diamond (2001)). After the 7<sup>th</sup> minute, the mobile left lane closure lead to local traffic congestion. Consequently, the data collected after the 7<sup>th</sup> minute was invalid.

A similar situation under day conditions happened to Truck 10 which was trialled for only 9 minutes (size sample  $N = 87 > 30$  minimum: Condra (2001) and Diamond (2001)).

Truck 9 during night and Truck 12 during day were run for 10 minutes only, due to technical problems associated with the video equipment.

Under night conditions, Truck 10 was trialled for 10 minutes only because weather conditions deteriorated, with light rain after the 10<sup>th</sup> minute. Due to reduced visibility and pavement skid resistance, the trial was stopped.

Deploying the video cameras on the bridge covered the study part of the motorway. However, the invisible area underneath the bridge 180–200 m from the parked TMA required dividing the results from this area into three equal values for 180, 190, and 200 m.

## 8. Analysis of results

### 8.1 Introduction

The data collected from the TMA trials were evaluated to examine traffic behaviour under each of the different VES arrangements. One-way Analysis of Variance (ANOVA) was computed for a quantitative dependent variable, i.e. driver's recognition distance (RD), by a single factor independent variable, i.e. VES mounted on a TMA). ANOVA assisted with determining whether differences among the different VES were significant in terms of the dependent variables.

Additional measurement analyses were undertaken for each study focusing on the percentage of drivers passing the Stopping Sight Distance (SSD) and passing the Braking Distance (BD). SSD is defined as the minimum distance required by an average driver of a vehicle travelling at the design speed to perceive an object on the road ahead, react, and stop safely before reaching it. It has two components: the distance travelled during the driver reaction time, and the distance travelled during braking called the Braking Distance. According to Transit guidelines (2000) these values for the locations selected for the two studies were 300 m (SSD) and 210 m (BD) respectively.

### 8.2 Study 1: Trial of existing TMA set-ups

Recognition distances ranged significantly among different VES mounted on the trial Trucks during day and night operations. Throughout this discussion, Trucks 1, 5, and 8 are used as baselines, because they are widely available and currently used by the roading industry, and all comply with Transit's CoPTTM (2004). All these trucks had beacon lights and arrow boards operating in a sequential mode, and all, except Truck 8, had retroreflective tape on the message board.

#### 8.2.1 Day conditions

The overall ranking analysis of the performance of all six Trucks under day conditions, based on the 'mean recognition distance' (SSD and BD), is summarised in ascending order in Table 8.1.

**Table 8.1 Summary of ranking of performance (green = best; yellow = average; red = poor) of the VES of existing TMA under day conditions for Study 1.**

Truck – VES	Mean recognition distance (m)	% Cars reacting after SSD of 300 m	% Cars reacting after BD of 210 m
Truck 6 – rotating beacon and flashing halogen lights on	418.40	29.9	14.4
Truck 3 – rotating beacon on (chevron mode)	379.82	41.2	17.6
Truck 5 – rotating beacon on	371.68	38.7	20.9
Truck 8 – rotating beacon on, no retroreflective tape	362.01	43.9	28.8
Truck 1 – rotating beacon on	349.95	41.2	23.2
Truck 2 – rotating beacon off	261.00	68.8	48.8

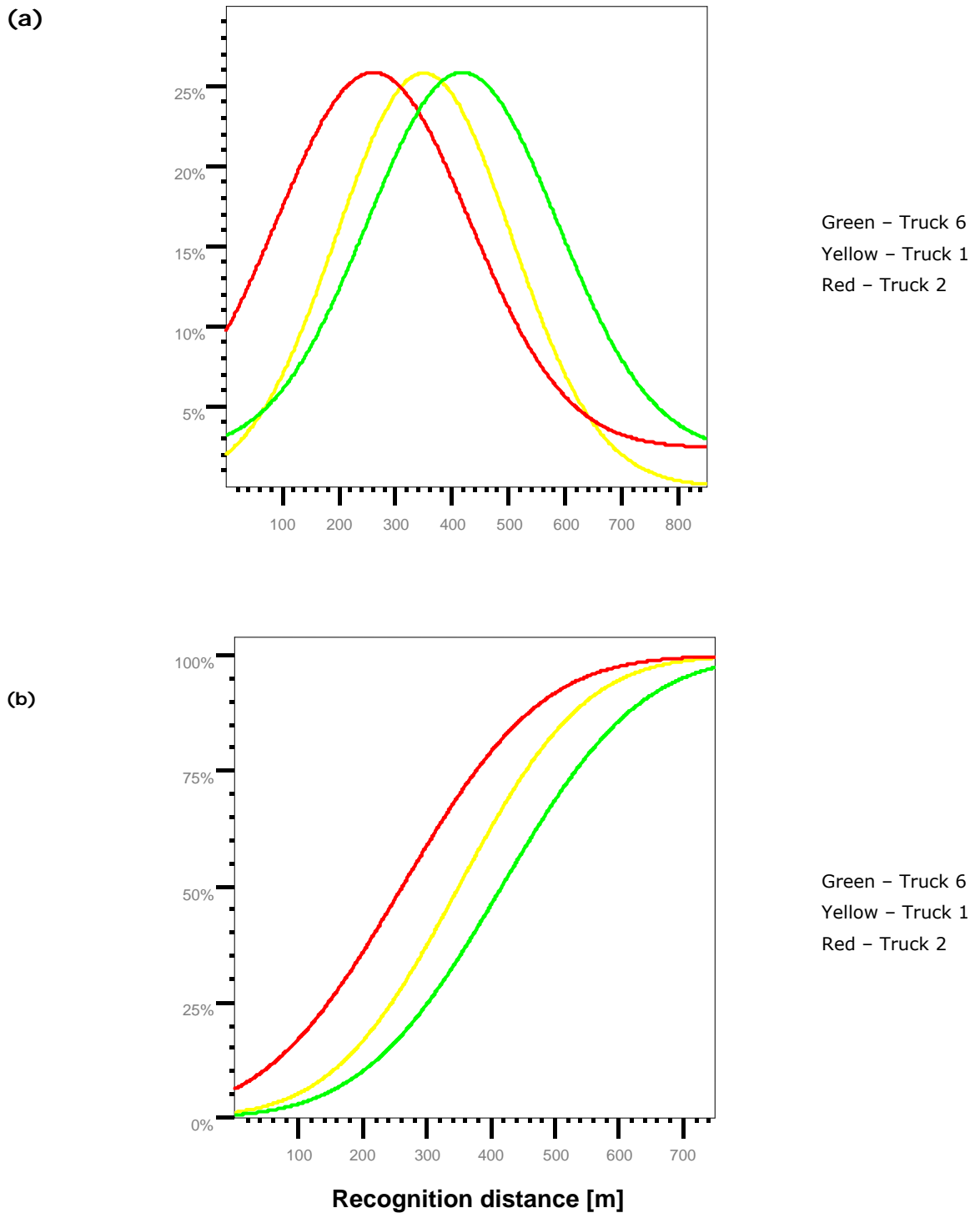

Figure 8.1 (a) Graphs and (b) cumulative curves for the relationships of VES on Trucks 6 (best), 1 (average), and 2 (poorest), for their different performances under day conditions.

Graphically, the relationship between Truck 6 (best), Truck 1 (selected to represent the 'average' VES) and Truck 2 (poorest) are presented in Figure 8.1(a) and (b) which illustrates the differences in their performances.

In this particular study, several VES set-ups mounted on TMA under- or over-performed (i.e. worse or better) compared to the baseline set-ups in terms of the differences in recognition distances. These differences in distance can be translated to gains or losses in perception–reaction time and has been used in the past to evaluate time margins for crash-avoidance behaviour when encountering a hazard in the driving path (Homburger et al. 2001; Roess et al. 2000).

Overall, the perception–reaction process can be significantly improved by fitting additional flashing lights. This was the case for Truck 6 which had four halogen lights mounted on each corner of the arrow panel. This particular VES improved drivers' recognition distance by an average of 47 m compared to the baseline Truck 5 (i.e. from 372 m up to 418 m). In terms of reaction time, this can be computed from Equations 8.1 and 8.2.

Constant speed:

$$D = V_i \times t \quad \text{Equation 8.1}$$

where:

- $D$  – Reaction distance (m)
- $V_i$  – Initial speed (m/s)
- $t$  – Perception–reaction time (PRT) (s)

Hence:

$$T = \frac{D}{V_i} \rightarrow \Delta t = \frac{\Delta D}{V_i} \quad \text{Equation 8.2}$$

Assuming that the drivers were travelling at 100 km/h (28 m/s), the halogen lights improved the drivers' perception–reaction time by 1.4 to 2.5 seconds on average, in comparison with the baseline trucks. Mounting flashing lights follows the trends in practice and experience of countries such as UK, Germany, Sweden, and several US states. These countries use either rotating beacons and/or strobe lights, of a minimum diameter of 8 inches (20 cm), on maintenance vehicles, school buses, emergency-response vehicles, or road signs. Also, the finding supports those of a study by Hanscom & Pain (1990, cited in Kamyab 2002), undertaken in the US. They concluded that a combination of rotating beacons with flashing strobe lights was effective in both moving and stationary TMA operations.

Under day conditions, Trucks 1, 5, and 8 were equally as recognisable by drivers who on average reacted 350–372 m in advance. Each of the trucks was provided by a different contractor, so they differed in size of message board, mounting height of arrow panel, and use of retroreflective tape, but these different arrangements did not prove to be significantly different under day conditions. As well, Truck 3 operating with the chevron display mode differed to the baseline trucks operating with the sequential display mode, but showed no significant change to drivers' performances.



This practice is in accordance with the US practice described in MUTCD (FHWA 2003) which permits chevron mode display as well as a flashing arrow.

Truck 2 with rotating beacon lights turned off was the most ineffective set-up with the poorest performance. Drivers reacted 89 m or 3.2 seconds later in comparison with the next poorest set-up, i.e. Truck 1. Even though the beacon light beam intensity was minimised by natural daylight, the presence of the rotating beacon still resulted in an increase of drivers' awareness of the potential hazard, and hence reduced the time of the perception–reaction process. Therefore the deduction is that beacon lights significantly improve visual information processing, resulting in faster and more accurate decision-making by drivers. Rotating beacon lights are extremely effective in day conditions.

### 8.2.2 Night conditions

The overall ranking analysis of the performance of Trucks 1, 2, 3, 4, 5, 7, 8 under night conditions, based on the 'mean recognition distance' comprising SSD and BD, is summarised in ascending order in Table 8.2.

**Table 8.2 Summary of ranking of performance (green = best; yellow = average; red = poor) of VES of modified and existing TMA under night conditions for Study 1.**

Truck – VES	Mean recognition distance (m)	% Cars reacting after 300 m SSD	% Cars reacting after 210 m BD
Truck 1 – rotating beacon on	545.98	10.9	5.4
Truck 4 – rotating beacon on, Variable Message Sign	531.50	16.5	3.1
Truck 3 – rotating beacon on (chevron mode)	527.41	18.5	4.6
Truck 5 – rotating beacon on	473.98	20.4	8.7
Truck 8 – rotating beacon on, no retroreflective tape	436.00	37.5	22.5
Truck 2 – rotating beacon off	405.15	38.1	10.3
Truck 7 – rotating beacon off and flashing halogen lights on	389.28	45.4	13.4

Graphically, the relationships between Truck 1 (best), Truck 5 (selected to represent the 'average trucks') and Truck 8 (the poorest, and used now on New Zealand roads) are presented in Figure 8.2(a) and (b) and illustrate the differences in their performances.

Interestingly, under night conditions, no consistent trend was observed when compared to day conditions. Several VES set-ups mounted on TMA under- or over-performed compared to the baseline set-ups (i.e. Trucks 1, 5, and 8), and as well significant differences were found within the baseline.

A number of implications became evident by studying this data. First, Truck 1 proved to be the best VES configuration and outperformed Truck 5 by 72 m and Truck 8 by 110 m for recognition distance.

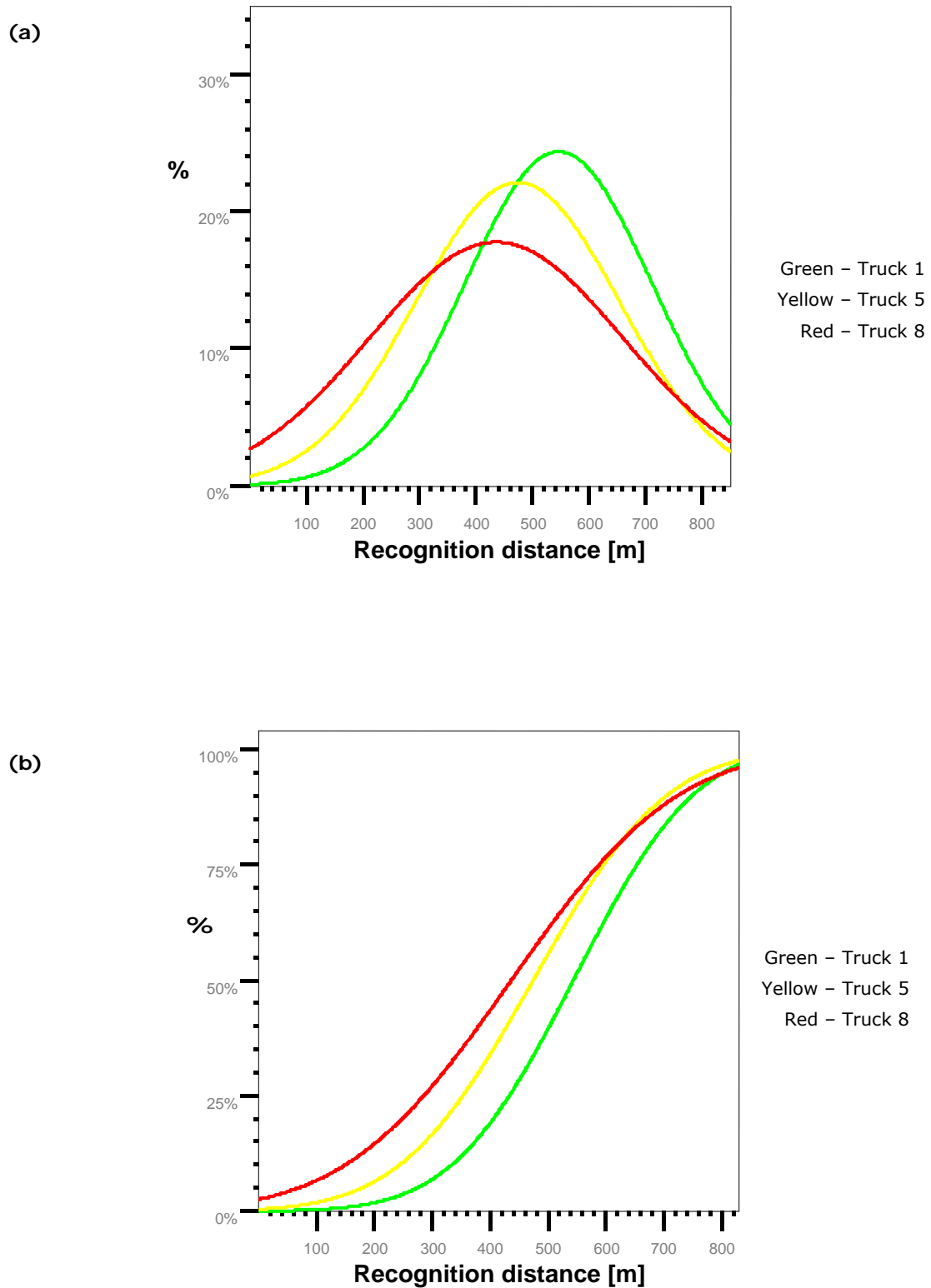

Figure 8.2 (a) Graphs and (b) cumulative curves for the relationships of VES on Trucks 1 (best), 5 (average), and 8 (poorest), for their different performances under night conditions.

Further investigation suggested that the poor performances of Trucks 5 and 8 were related to the heights of their message boards which therefore meant lower positions of arrow panels and rotating beacon fittings than in Truck 1. This result demonstrated that mounting VES as high as practicable can improve drivers' perception–reaction times.

Second, Truck 8 had no retroreflective tape on the message board; this lack of retroreflectivity and therefore reduction of visibility at night led to inadequate detection ability. Fitting retroreflective tape improves the detection and recognition of a truck as it bounces light from vehicle headlights back toward the vehicle and the driver's eyes, and it makes the truck appear brighter and easier to see at night.

Consequently such conspicuity markings significantly improve visual information processing resulting in faster and more accurate decision-making by drivers (Charlton 2004; Blanco 2002; Kamyab 2002, 2001; Morgan 2001; Carlson & Hawkins 2003, Carlson et al. 2000; Fontaine 2000; Hanna 2000; Stout et al. 1993). Recent studies undertaken in the US showed that drivers rely on what they can see, hence the reflective marking reduces the probability of serious accidents (Morgan 2001). Also, Truck 8's message board was painted in bright colour and this reduced the contrast between the arrow panel and its background (Helmets et al. 2004; Fuller & Santos 2002; Kuhn 1997).

Overall, Truck 1 proved to be the best VES configuration but not significantly different from Truck 3 (operating in chevron mode) or Truck 4 (Variable Message Sign). The mean recognition distances of all three trucks ranged from 527 m to 546 m, and all had rotating beacon lights operating, but they differed in message type display. Consequently, it can be deduced that the drivers' reaction was based on the use of the beacon lights which, under night conditions, can be seen from greater distances since the light beam reflects from the unlit road and its surrounding environment. The results also reveal for Trucks 3 and 4 that more drivers tended to cross the SSD point (300 m) by 7.4% and 5.6% respectively. This could be due to chance alone or explained by the more complex chevron and variable message display modes which have a loss of contrast at further distances.

However, under no circumstances should the VES practice follow those used on Trucks 2 and 7, which were considered to have the poorest VES configurations. Because the stronger light of a beacon activates driver's visual acuity and contrast sensitivity (Sanders & McCormick 1993), Truck 2 with its rotating beacon off proved to be an ineffective configuration as expected. On average, drivers reacted 141 m later than for the same Truck that had the rotating beacons on.

Although the literature review suggested that fitting flashing lights could out-perform the beacon lights set-up, Truck 7 however did not achieve this goal. This Truck was fitted with four halogen lamps at the corners of the arrow panel, and demonstrated a decrease in drivers' perception–reaction time. Probably activation of the halogen lamps resulted in a reduction of the contrast sensitivity between arrow panel and its surroundings.

These trends suggest that positive sign contrasts are better than negative sign contrasts as the increase of luminance ratio causes decrease in recognition distance. This is in accordance with Kuhn's (1997) research. The other reason for this performance reversal

is attributable to problems with the technical aspect of this particular truck. The TMA operator of Truck 7 could not reduce the intensity of the halogen lights for the night conditions, which is regulatory practice for arrow panel intensity to avoid dazzling the drivers (Transit 2004). It can be hypothesised that fitting the halogen flashing lights on the top of the message board, where it does not impair the performance of the arrow panel in terms of contrast and flashing frequency, should improve the drivers' perception-reaction times.

Most VES configurations were trialled for both day and night conditions. However, day and night results differ from each other and overall the night results were 20% to 56% better than day results. It can be assumed that these differences were based on contrast sensitivity, the characteristics of samples, and traffic volume.

The visibility of lighting significantly improves during night-time related to the positive contrast between darkness and the source of light, in that most of the light perceived by the eyes is a reflection from the objects in the surrounding environment. This reflection provides information about the nature of the object (Blanco 2002; Kandel 2000; Kuhn 1997). In addition, the headlight beams of approaching cars amplify the visual acuity and contrast sensitivity of a driver; a stronger light and background luminance of a TMA activates cells in the eye's retina that are sensitive to low light conditions, and therefore result in higher acuity and sensitivity (Kamyab 2002; Kuhn 1997).

In addition, studies have shown that day drivers differ significantly from night drivers. For example Fuller (2002) recorded relevantly fewer elderly drivers during the night of Monday to Thursday. This could be related to their social behaviour patterns. Therefore, day results could be lower as more people with attention and sight impairments are driving, and are likely to have difficulties with selecting relevant information from the road environment, especially when a lot of information is presented at high rate (Roess et al. 2004).

The last factor, but the most important, strongly suggests that the lower traffic volume (i.e. approximately 100 veh/15 min. for Study 1 under night conditions), and therefore the traffic density influences the drivers' recognition distance. Under high volume (i.e. approximately 220 veh/15 min. for Study 1 under day conditions), some drivers had their inter-visibility (i.e. visibility between other vehicles and a hazard ahead) constrained. But also it could be hypothesised that they are focused on monitoring the activities of other drivers who may cause a potential risk to them, instead of observing the far-distance situation. Consequently, lower traffic volume at night increased the 'recognition distance' as the drivers' vision was rarely ever impaired or affected by other vehicles.

### **8.3 Study 2: Trial of existing and improved TMA set-ups**

Based on the results from Study 1, the best performing TMA were again trialled in Study 2 as a baseline for comparison with new TMA designs and set-ups.

Under day conditions in Study 1, the most efficient VES was mounted on Truck 6, which included rotating beacon and operating halogen lights.

Under night conditions in Study 1, Truck 1 outperformed most of the other Trucks and also is the most common existing configuration used on the road network.

Recommendations that became evident for testing new TMA designs and used in Study 2 included a modified Truck 1 with flashing strobe lights, a new TMA imported from Germany, as well as deploying advance warning on the road shoulder, which is common practice for other countries using TMA.

### 8.3.1 Day conditions

The overall ranking analysis of the performance of Trucks 11, 12, 6, 10 under day conditions, based on the mean recognition distance, SSD and BD, is summarised in ascending order in Table 8.3.

**Table 8.3 Summary of ranking of performance (green = best; yellow = average) of VES of modified and existing TMA under day conditions for Study 2.**

Truck – VES	Mean recognition distance (m)	% Cars reacting after SSD of 300 m	% Cars reacting after BD of 210 m
Truck 11 – new TMA + advance warning – diagram display	455.15	10.9	1.8
Truck 12 – new TMA + advance warning – wordy display	439.70	8.2	2.2
Truck 6 – rotating beacon and halogen on	355.94	38.6	28.7
Truck 10 – new TMA	348.51	42.5	27.6

Graphically, the relationships between Trucks 11 (best) and Truck 10 (selected to represent 'average trucks') are presented in Figure 8.3(a) and (b) to illustrate the differences in their performance.

As expected, the advance warning showed the most significant improvement for TMA operations. Both Trucks 11 and 12 involved positioning the advance warning sign 400 m in advance, which resulted in at least 27.7% fewer drivers reacting in the last 300 m and at least 25.4% fewer drivers reacting in the last 210 m when confronted with Trucks 6 and 10 without advance warning.

As discussed in Chapter 6, international practice strongly relies on technologies to inform the driver about the TMA operation, and supplementing it with a diagram of a lane closure. Although Transit's CoPTTM (2004) requires positioning a Tail TMA on the shoulder 100 to 600 m from the Shadow TMA, this proposed advance warning is inadequate.

Tail TMA are required to be mounted with an arrow panel, rotating beacon lights, wordy signs stating '*Lane closed XXX meters ahead*' and '*Men working on the road*' or '*Roadworks ahead*'. Each of these devices requires the driver to identify and to read them before undertaking an adequate response.

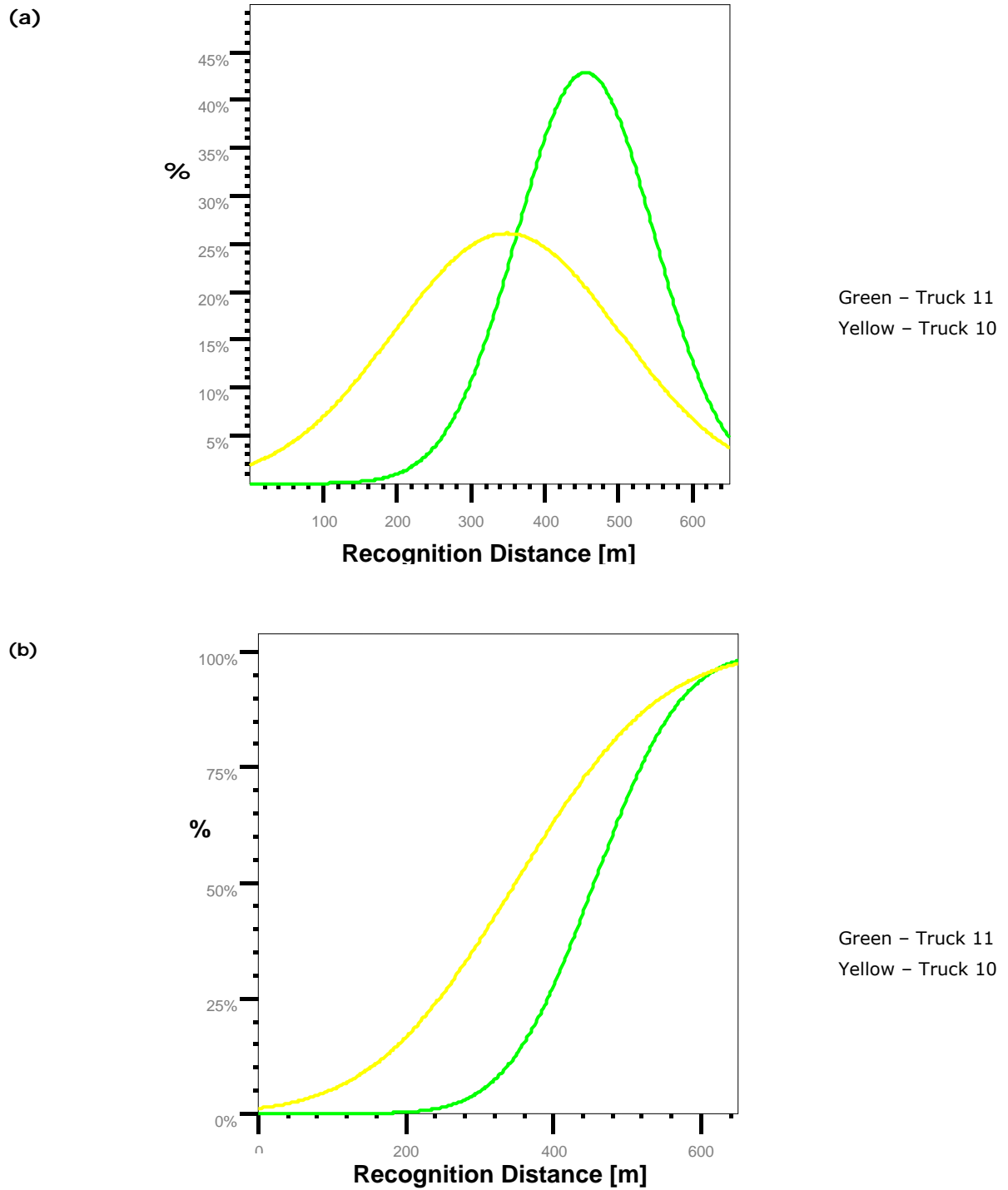

Figure 8.3 (a) Graphs and (b) cumulative curves for Trucks 10 (average) and 11 (best), under day conditions.

However, too much information only serves to distract the driver or to be simply ignored, especially the ones with a wordy ambiguous message (Ogden & Bennett 1996; Sanderson 1972) or with small font size (Kuhn 1997).

The advance warnings used in this study aimed to provide the drivers with simple messages and to attract their attention by means of strobes operating on the top of the board. Nevertheless this study did not prove the superiority of the diagram message display over the wordy message display, as suggested by Sanderson (1972). This lack of proof could be explained by the limited visibility of the advance warning signs of only 250 m because to the road curvature.

No significant differences were found between the performance of Trucks 6 and 10. Truck 10 presented an entirely different design with the skewed arrow panel (Figure 8.4), the strobe lights, and an additional RG-17/34 (Table 7.2, Truck 10) mounted on the bottom of the message board, but none of these devices outperformed the VES mounted on Truck 6 (i.e. horizontal arrow board + rotating beacon and flashing halogen lights). One explanation could be that the driver's driving performance is strongly based on their recollection from previous experiences of another TMA (Fuller & Santos 2002; Knapp 1998/1999). Hence using a new TMA design in public for the first time may result in diminished drivers' performance because it is novel. Another explanation is that the new design is no better.



**Figure 8.4** A new type TMA on Truck 10 in the Study 2 trial.

### **8.3.2 Night conditions**

The overall ranking analysis of the performance of Trucks 11, 12, 9, 10, 1 under night conditions, based on the mean recognition distance, SSD and BD, is summarised in ascending order in Table 8.4.

**Table 8.4 Summary of ranking of performance (green = best; yellow = average; red = poor) of VES of modified and existing TMA under night conditions for Study 2.**

Truck – VES	Mean recognition distance (m)	% Cars reacting after SSD 300 m	% Cars reacting after BD 210 m
<b>Truck 11</b> – new TMA + advance warning – diagram display	443.09	5.3	1.1
<b>Truck 12</b> – new TMA + advance warning – wordy display	429.50	4.0	1.0
<b>Truck 9</b> – rotating beacon off, flashing strobes on	408.28	20.7	6.9
<b>Truck 10</b> – new TMA	399.56	22.1	5.9
<b>Truck 1</b> – rotating beacon on	373.50	32.0	17.0

Graphically, the relationships between Truck 11 (the best), Trucks 9 and 10 (representing 'average trucks') and Truck 1 (poorest) are presented in Figure 8.5(a) and (b) to illustrate the differences in their performance.

Similar patterns of the new TMA performance under day conditions were followed during the night trials. Expectedly, the advance warning proved to be the most effective warning system to drivers, and resulted in at least 15.4% fewer cars reacting in the last 300 m and at least 5.8% fewer cars reacting in the last 210 m. Again, no differences were found between advance warning with the diagram display and advance warning with the wordy display.

Trucks 9 and 10, which mainly differed on the type of mounted arrow panel, showed similar performances under night conditions, and both were considered to be averagely performing TMA within this group.

However, the flashing strobe lights outperformed the rotating beacon lights as expected with Truck 1 which was considered to be the poorest VES set-up. The lighting set-ups mounted on Trucks 1 and 9 did not significantly alter the mean recognition distance but reactions in the last 300 m approaching the TMA were diverse, suggesting that flashing strobe lights were superior to rotating beacon lights. This is in accordance with international practice (in UK, Germany, Sweden, and several US states) where strobe lights are used on TMA.

The reaction patterns in the last 300 m showed that 11.3% more drivers reacted to the rotating lights than to the strobe lights, probably because the contrast between the rotating lights and the arrow panel display is lost, or the driver is blinded by the lights when approaching their source. The narrow-beam strobe lights are obvious further from the source but are not in the driver's line of sight at closer distance, and thus do not cause glare (Adolf Nissen Electrobau 2001; Kamyab 2002).

The superiority of the advance warnings over any other set-ups lies in the consistency of their mean recognition distances under both day and night conditions, as shown by differences in RD as low as 10 to 12 m. This suggests that diverse traffic flow conditions and/or time of the day have no effects on the overall superior performance of TMA set-ups that have an advance warning system.



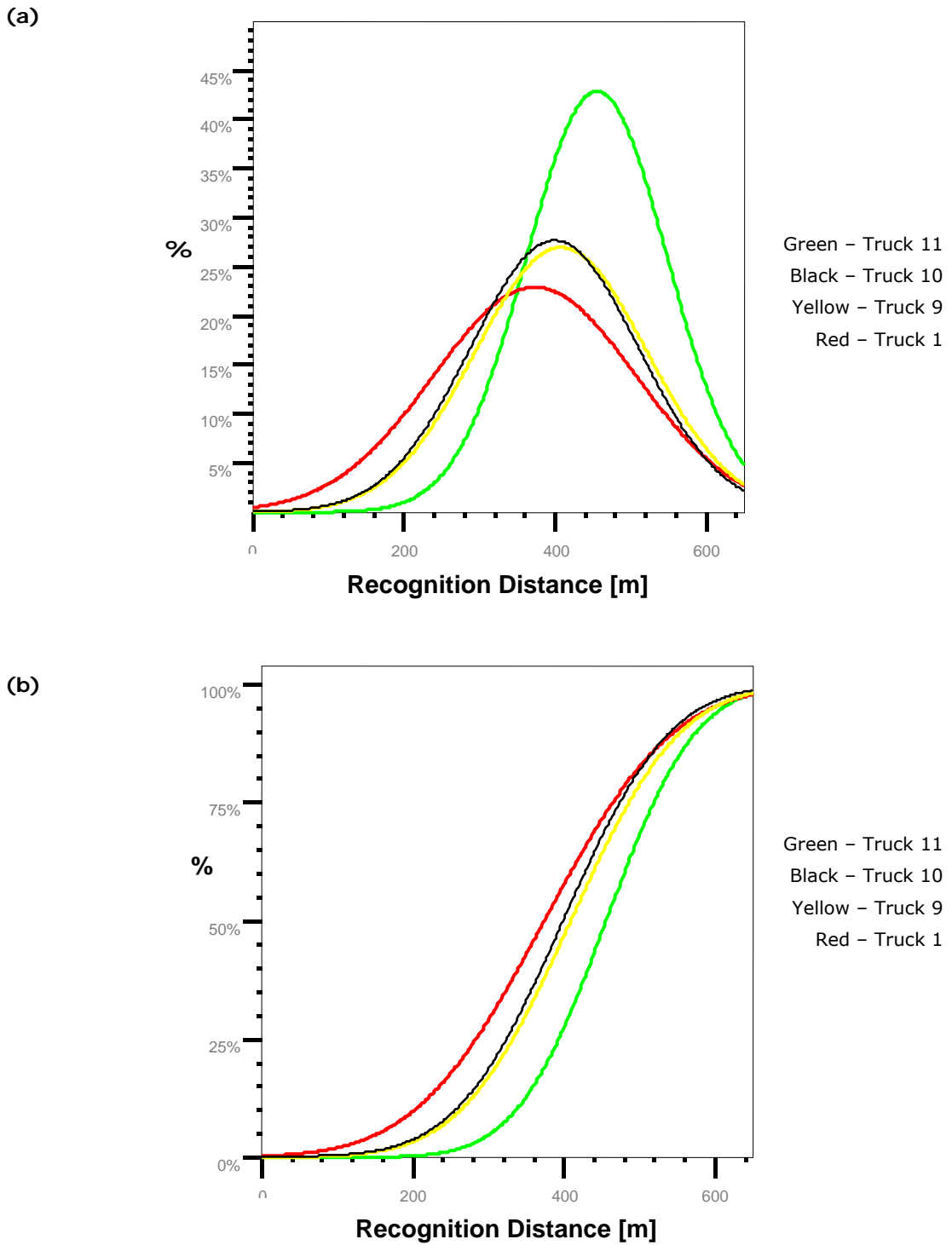

Figure 8.5(a) Graphs and (b) cumulative curves for Trucks 1 (poorest), 9 and 10 (average), and 11 (best) under night conditions.

## **8.4 Limitations of the study**

The following limitations associated with this study are:

- Stationary Mobile Operations only were trialled. Rolling Mobile, Semi-Static and Static Operations were not addressed.
- Truck 6 was only trialled during the day and Trucks 4 and 7 were only trialled at night. Trials of the other set-ups were not completed because of financial constraints.
- The characteristics of the technologies mounted on TMA (i.e. warning lights) may differ between those used by the industry sponsors and those available on the market, such as luminous output levels, cutoff angle etc. Only the technologies currently used by the industry sponsors were tested.

## 9. Conclusions

The principal goal of this research effort was to study the relationships between recognition distance and different configurations of Visual Enhancement Systems (VES) mounted on Truck Mounted Attenuators (TMA), during day and night operations, under clear weather conditions.

The overall results regarding TMA use in relation to drivers' perception–reaction times, strongly suggest that:

- *Advance warning systems gave a TMA set-up which out-performed any other set-up, during either day or night.*

Under day conditions, the set-up with an advance warning system resulted in at least 27.7% fewer drivers reacting in the last 300 m, and at least 25.4% fewer drivers reacting in the last 210 m.

Under night conditions, this set-up resulted in at least 15.4% fewer drivers reacting in the last 300 m and at least 5.8% fewer drivers reacting in the last 210 m.

- *Flashing strobe lights mounted as on Truck 9, improved drivers' reactions.*

These lights gave enhanced capabilities over rotating beacon lights, with at least 11.3% fewer drivers reacting in the last 300 m under night conditions.

Flashing strobe lights greatly out-performed the orange rotating beacons as they improved drivers' perception–reaction times and recognition distances.

- *Under day or night conditions, wide retroreflective tape around the edges of the arrow board, as on Truck 5, significantly improved drivers' average Recognition Distance of the TMA by at least 38 m.*

At least 17% fewer drivers were reacting in the last 300 m for Truck 5 when compared with Truck 8 which did not have retroreflective tape.

- *Recognition Distances increased at night when traffic volumes are lower compared to Recognition Distances recorded during the day with higher traffic volumes.*

The results of this study also illustrate the possibility that VES currently used on TMA have the potential to adversely affect driving and create unsafe circumstances by providing drivers with inefficient messages.

They also highlight the most desirable improvements that can be made to VES mounted on TMA, which should decrease the number of incidents and fatalities associated with TMA operations currently occurring on New Zealand roads.

## 10. Recommendations

TMA operations without adequate advance warning tend to reduce the speed of traffic flow thereby increasing the potential for car crashes. To overcome this problem, the following recommendations for design and use of TMA are made, based on the findings of this study, for inclusion in future versions of CoPTTM.

### *Positioning traffic management equipment*

- Advance warning systems that are simply and clearly understood should be used immediately.
- Positioning the advance warning system on the road shoulder at a minimum distance of 400 m before the Shadow TMA, is required for mobile operations.

Positioning advance warning on the shoulder of the road 400 m before the shadow vehicle in the live lane, forewarns the driver that the lane ahead is closed. This is enough distance in which to react and respond in a safe manner, and the driver's perception process is significantly improved. It also helped drivers of vehicles following close behind large trucks, and who often could not see the TMA ahead (i.e. restricted inter-visibility). The advance warning provided the critical and specific information that the lane ahead was closed much earlier, thus giving the driver longer time to react.

- The message should be displayed in diagram form or as a sign with large descriptive text.
- As the message displayed requires special attention from the driver, the advance warning system should have two 340-mm flashing strobe lights mounted on its top to inform the driver of the lane closure ahead.
- If drivers have been appropriately informed, they will have enough distance to respond safely, and then a Tail TMA need not be used for left-lane closures.

### *Increasing the visibility of TMA truck units*

#### *– by flashing strobe lights*

- Flashing strobe lights of 340-mm diameter provide better information, out-perform the rotating beacons, and result in quicker responses from drivers. The lights should be mounted as high as practical above the arrow board and advance warning system so they do not conflict with the visual performance of these signs.
- The flashing should be set to operate when the arrow board lights are not on, so that drivers see an alternating pattern of the arrow board message and the flashing strobe lights. Flashing should be at alternating frequencies.
- Lights must be positioned far enough apart from the arrow board or the two operations will conflict, the visual sensitivity to the arrow board will be reduced, and the message will not be clear to the driver.

**– by retroreflective tape**

- The arrow board must be fitted with wide retroreflective tape around the edges of the board. Attaching these strips enhances the shape and size of the TMA to make them appear brighter and easier to see at night.
- Retroreflective tape, usually associated with the roadwork sites, promotes safe driving and makes a TMA more recognisable from the rest of the traffic.

**– by use of supplementary warning signs**

- A large RG17/34 sign with up-lighting that operates to the left or the right, in co-ordination with the illuminated arrow board, can improve drivers' recognition of the required lane shift ahead.
- For optimum operation at night, this sign should be illuminated with a plain white light directed downwards.
- Inclusion of a European-type arrow board and associated directional change arrow signs fitted to the rear and strobe lights fitted at the top of the TMA out-performed the typical standard TMA (with rotating lights).

However, European-type TMA performed no better than the existing TMA that have been modified with strobe lights.

***Timing of operations***

- Mobile operations for roadworks are best undertaken during off-peak hours when the lower traffic volumes increase driver Recognition Distance. Drivers then have increased inter-visibility, compared with conditions under the higher traffic volumes during peak hours.
- During off-peak hours, the merging manoeuvre to the open lane is easier to complete, vehicles do not have to queue behind the TMA, and the traffic stream should flow smoothly.

## **11. Future research**

Several possibilities exist for future research to improve Truck Mounted Attenuator operations. The research did not focus on all possible ways of unifying the operational and visual issues surrounding the use of TMA. Therefore the need is to investigate other factors that may improve the driver's performance to perceive TMA and respond quickly taking appropriate action in a safe and timely manner. These recommendations are as follows:

- Further validate the results for TMA operations by investigating the effects of different road conditions, such as those on Level 2 roads where lower speeds are applied, and on Level 3 roads which need closure of the fast lane in which the potentially riskier drivers are travelling.
- Trials of the advance warning signs involved use of a variable message sign. However, other types of static signs should also be tested to see if they have the same effectiveness because these would be more affordable for the industry.
- Size of the Message Board may have a positive effect on the traffic flow if designed accurately. Height of the European TMA message board exceeds that of New Zealand TMA, but the appropriate size needs further investigation, especially if the same device is to be used on Level 2 roads.
- Colour of the Message Board and use of retroreflective tape need unification. At present this varies throughout the industry and is also widely applied on commercial trucks. Application of the one standard design that is already obligatory for maintenance vehicles, will make TMA more recognisable from the rest of the traffic while they are operating on the road, and therefore promote safe driving.
- Flashing warning light frequency varies between countries, and hence optimal practice for the flashing frequency requires further investigation. Additionally, this may prompt an investigation to see if rotating frequencies should be different for flashing strobe lights than for rotating beacon lights.
- Trials using the Tail TMA were only for left-lane closures. Further trials are required to determine if the results for right-lane closures are the same.

In addition, public education on road works may be crucial if the current New Zealand crash rate associated with TMA operations is to decrease. This requires designing an education programme for drivers and, most importantly, including this in the Land Transport (Road User) Rules and driving tests for new drivers.

## 12. References

- AA (New Zealand Automobile Association Inc.). 2005. *AA Directions – Autumn*. Auckland: NZ AA Inc.
- Adolf Nissen Elektrobau GmbH + Co KG. 2001. *Road Hazard Warning Equipment*. Products' catalogue cd, Tönning: Adolf Nissen Elektrobau GmbH + Co KG.
- Blanco, M. 2002. *Relationship between driver characteristics, nighttime driving risk perception, and visual performance under adverse and clear weather conditions and different vision enhancement systems*. PhD Thesis paper, Virginia Polytechnic Institute and State University, US.
- Bundesminister für Verkehr. 1997. *Technische Lieferbedingungen für fahrbare Absperrtafeln. TL-Absperrtafeln 97*. Köln: FGSV Verlag GmbH.
- Bundesminister für Verkehr. 1991. *Technische Lieferbedingungen für Warnleuchten. TL-Warnleuchten 90*. Köln: FGSV Verlag GmbH.
- Carlson, P.J., Hawkins, H.G. 2003. Minimum retroreflectivity levels for overhead guide signs and street-name signs. *Report No. FHWA-RD-03-082*. Texas: Texas Transportation Institute.
- Carlson, P.J., et al. 2000. Evaluation of traffic control devices for rural high-speed. Maintenance work zones. *Report 1879-1*. Texas: Texas Transportation Institute.
- Charlton, S.G. 2004. *Conspicuity, memorability, comprehension, and priming in hazard warning signs*. Hamilton, NZ: Traffic & Road Safety Research Group, University of Waikato.
- Collings, J.C. 2004. *Applying context sensitive design to the innovative development of major highway projects*. FICE Collings Johnston Inc.
- Condra, L.W. 2001. *Reliability improvement with design of experiments*. New York: Marcel Dekker, 2<sup>nd</sup> ed. 142pp.
- Diamond, W.J. 2001. *Practical experiment designs for engineers and scientists*. New York: John Wiley & Sons, Inc. 91pp.
- Fambro, D.B. (Ed). 1997. Determination of stopping sight distances. *National Cooperative Highway Research Program 400*. 84pp. + Appendix.
- Federal Highway Administration (FHWA). 2000. *The manual on uniform traffic control devices*. Millennium Edition. Washington, DC: FHWA, US Department of Transportation. Chapter 6A – 6H.
- Federal Highway Administration (FHWA). 2003. *The manual on uniform traffic control devices*. Washington, DC: FHWA, US Department of Transportation. Chapter 6A – 6H.

- Federal Highway Administration (FHWA). 2005. *How retroreflectivity makes our roads safer*. Available [online] from <http://safety.fhwa.dot.gov/media/nightlights.htm> [Accessed 19 February 2005].
- Federal Highway Administration (FHWA). 2005. *Driver night visibility needs*. Available [online] from [http://safety.fhwa.dot.gov/roadway\\_dept/retro/gen/back\\_needs.htm](http://safety.fhwa.dot.gov/roadway_dept/retro/gen/back_needs.htm) [Accessed 19 February 2005].
- Fontaine, M.D. et al. 2000. Evaluation of traffic control devices for rural high-speed maintenance work zones: Second year of activity and final recommendations. Texas: *Texas Transportation Institute, Report 1879-2*.
- Fuller, R., Santos, J.A. (Eds). 2002. *Human factors for highway engineers*. Oxford: Pergamon, An Imprint of Elsevier Science Ltd.
- Griffith, M.S. 2003. *Letter to Mr Stephens on Safe-Stop 180 TMA tests*. Energy Absorption Systems, Inc.
- Hanna, A.N. 2000. Improved visibility for snowplowing operations. *National Cooperative Highway Research Program (NCHRP) Project 6-12*. New York: Research results digest, Rensselaer Polytechnic Institute.
- Hanscom, F.N., Pain, R.F. 1990. Service vehicle lighting and traffic control systems for short-term and moving operations. *NCHRP Report 337*. Washington, DC: Transportation Research Board, National Research Council.
- Helmers, G., et al. 2004. *Traffic environment for older drivers. Analysis and recommendation based on literature survey*. Linköping: Swedish National Road and Transport Research Institute.
- Homburger, W.S., et al. 2001. *Fundamentals of traffic engineering*. 15th ed.: 3-1-3-10; 9-1-9-15; 15-1-15-3. Berkeley: Institute of Transportation Studies, University of California.
- Institute of Transportation Engineers (ITE). 1993. *The traffic safety toolbox: a primer on traffic safety*. Washington, DC: Institute of Transportation Engineers: 179-184.
- Kamyab, A. 2002. *Synthesis of best practice for increasing protection and visibility of highway maintenance vehicles*. Ames: Iowa State University, Center for Transportation Research and Education.
- Kamyab, A. 2001. *Fluorescent yellow-green background for vehicle-mounted work zone signs*. Ames: Iowa State University, Center for Transportation Research and Education.
- Kandel, E.R., et al. 2000. *Principles of neural science*. 4th edition: 492-589. Columbia University and The Howard Hughes Medical Institute.
- KIWIMinimaps Ltd. 2003. *Auckland, Hamilton & 28 Regional Towns. Compact Street Directory*. 9<sup>th</sup> edition, C.A. Boot.



- Knapp, K. 1998/1999. *Driver expectancy, traffic control, and roadway design*. Ames: Iowa State University, Center for Transportation Research and Education.
- Kuhn, B.T. 1997. *Determination of the impact of illumination and color on the legibility of typical on-premise sign font*. Thesis paper, Pennsylvania State University.
- Land Transport NZ (LTNZ). 2004. Project Proposal. *Best practice for use and design of truck mounted attenuators [TMA] in New Zealand*.
- Land Transport Safety Authority (LTNZ). *Drinking and driving statistics*. Available [online] from <http://www.landtransport.govt.nz/research/drink.html> [Accessed 21 February 2005].
- Land Transport Safety Authority (LTNZ). *Safety belt statistics*. Available [online] from <http://www.landtransport.govt.nz/research/belts.html> [Accessed 21 February 2005].
- Lay, M.G. 1986. *Handbook of road technology – volume 2: Traffic and Transport*: 673-678. New York: Gordon & Breach Science Publishers.
- Lay, M.G. 1984. *Source book for Australian roads*. 2<sup>nd</sup> ed: 193–199, 355–368. Vermont South, Victoria: Australian Road Research Board.
- Lerner, N., et al. 2004. *Comprehensive human factors guidelines for road systems*. Transportation Research Corporation: C-1–C-65.
- Maze, T. 2000. *Evaluation of work zone speed reduction measures*. Ames: Center for Transportation Research and Education, Iowa State University.
- Morgan, C. 2001. The effectiveness of retroreflective tape on heavy trailers. Washington: US: *Department of Transportation Report No. DOT HS 809 222*.
- National Association of Australian State Road Authorities (NAASRA) (Ed.) 1988. *Guide to traffic engineering practice – Part 8 – Traffic control devices*: 7. Sydney: NAASRA.
- NCHRP Report 350, Tests 50, 51 (cited in Transit NZ CoPTTM 2004).
- Nilsson, G. 2004. *Traffic safety measures and observance*. Linköping: Swedish National Road and Transport Research Institute.
- Odgen, K.W., Bennett, D.W. (Eds). 1996. *Traffic engineering practice*. 4th ed.: 1–37, 165–177, 448–467. Clayton, Victoria: Department of Civil Engineering, Monash University.
- Roess, R.P., et al. 2004. *Traffic engineering* 3<sup>rd</sup> ed.: 17–26, 130–158, 236–262. Upper Saddle River, NJ: Pearson/Prentice Hall.
- Sanders, M.S., McCormick, E.J. 1993. *Human factors in engineering and design*. 7<sup>th</sup> ed. New York: McGraw-Hill Inc.
- Sanderson, J.E. 1972. *A comparison of NZ worded and international symbol signs*.

- Schonborn/Schulte. 1997. *RSA Handbuch – Sicherung von Arbeitsstellen and Straßen. Band 2: ZTV-SA mit Kommentar: 98–114*. Koln: Kirschbaum Verlag GmbH.
- Schonborn/Schulte. 1995. *RSA Handbuch – Sicherung von Arbeitsstellen and Straßen. Band 1: RSA mit Kommentar: 105–115, 145, 250–254, 323–331*. Koln: Kirschbaum Verlag GmbH.
- Schreckenber, M., Selten, R. (Eds). 2004. *Human behavior and traffic networks: 193–204*. Berlin: Springer.
- Sillan, S.I. 1997. *Letter to M.J. Essex on FHWA acceptance and appliance on the Alpha 100K TMA*. Washington: FHWA, US Department of Transportation.
- Sillan, S.I. 1996. *Letter to Mr Essex on FHWA acceptance and appliance on the Alpha 70K TMA*. Washington: FHWA, US Department of Transportation.
- Sillan, S.I. 1994. *Letter to Mr Essex on FHWA guidelines procedures for the NCHRP Report 350 crash-tests for TMAs*. Washington: FHWA, US Department of Transportation.
- Stout, D., et al. 1993. *Maintenance work zone safety devices*. Washington: Strategic Highway Research Program National Research Council.
- Taylor, H.W. 2002. *Letter to Mr Stephens on FHWA acceptance and appliance on and NCHRP Report 350 Crash Test Results for the Safe-Stop 180 TMA*. Office of Safety Design.
- Transit New Zealand. 2004. *Code of Practice for Temporary Traffic Management (CoPTTM)*. Wellington: Transit New Zealand.
- Transit New Zealand. 2003. *State highway traffic volumes 2003 & related information*. Wellington: Transit New Zealand.
- Transit New Zealand. 2002 version. *Code of Practice for Temporary Traffic Management (CoPTTM)*. Wellington: Transit New Zealand.
- Transit New Zealand. 2000. *Draft state highway geometric design manual: 2-10–2-12, 2-24–2-28*. Wellington: Transit New Zealand.
- Transit New Zealand. 1997. *Code of practice Working on high capacity highways*. November 1997 draft. Wellington: Transit New Zealand.
- Treat, J.R., et al. 1979, cited in Charleston 2204. Tri-level study of the causes of traffic accidents. *Report DOT-HS-034-3-535-79-TAC(S)*. Bloomington, Indiana: Institute for Research in Public Safety.
- UK Highways Agency, et al. 2003. *Design manual for roads and bridge: the mobile lane closure technique for use on motorways and other dual carriageway roads*. London: The Stationery Office Ltd.

Vägverket. 2003. *Regler för säkerhet vid vägarbete och transporter: 47-52*. Linköping: Swedish National Road and Transport Research Institute.

Wright, F.G. 2000. *Letter to Mr Gertz on FHWA acceptance on Scorpion TL-2 and TL-3 TMA*. Washington: US Department of Transportation.

