

Traffic Control Devices Manual

Part 8

Code of practice for temporary traffic management (CoPTTM)

manual number: SP/M/010

Section J – Traffic management diagrams (TMDs)

© NZ Transport Agency

www.nzta.govt.nz

Fourth edition, Amendment 3 of
Code of practice for temporary traffic management

Date of issue: 1 October 2014

Effective date: 1 December 2014

ISBN 978-0-478-40772-3 (print)

ISBN 978-0-478-40773-0 (online)

Copyright information

This publication is copyright © NZ Transport Agency. Material in it may be reproduced for personal or in-house use without formal permission or charge, provided suitable acknowledgement is made to this publication and the NZ Transport Agency (NZTA) as the source. Requests and enquiries about the reproduction of material in this publication for any other purpose should be made to:
NZ Transport Agency
Private Bag 6995
Wellington 6141

The permission to reproduce material in this publication does not extend to any material for which the copyright is identified as being held by a third party. Authorisation to reproduce material belonging to a third party must be obtained from the copyright holder(s) concerned.

Disclaimer

The NZTA has endeavoured to ensure material in this document is technically accurate and reflects legal requirements. However, the document does not override governing legislation. The NZTA and its employees and agents involved in the preparation and publication of this document do not accept liability for any consequences arising from the use of this document. Users of this document should apply and rely upon their own skill and judgment, and should not rely on the manual's contents in isolation from other sources of advice and information. In applying their own skill and judgment, the standards of safety and serviceability explicitly required or implied by this manual shall not be reduced. If the user is unsure whether the material is correct, they should make direct reference to the relevant legislation or regulations and contact the NZTA.

More information

Published 2013





ISBN 978-0-478-40772-3 (print)

ISBN 978-0-478-40773-0 (online)

DIAGRAMS LIST







STATIC OPERATIONS

No.	LOW VOLUME ROADS	
SHOULDER AND BERM		
F1.1	Shoulder closure	
F1.2	Shoulder closure - low-risk (under 250vpd)	
TWO-WAY TWO-LANE ROAD		
F1.3	Lane closure - low-risk (under 250vpd)	Under 65km/h - must have CSD in both directions
F1.4	All traffic stopped temporarily	Manual traffic control
F1.5	Single-lane alternating flow	Manual traffic control
F1.6	Single-lane alternating flow	Portable traffic signals
F1.7	Single-lane	Give way control
F1.8	Short no exit road	

No.	LEVEL 1 ROADS	
FOOTPATH		
F2.1	Footpath diverted onto berm behind working space	First preference
F2.2	Footpath diverted onto berm between working space and carriageway	Second preference
F2.3	Footpath diverted onto carriageway	Third preference
F2.4	Footpath closed - permanent speed less than 65km/h	Fourth preference 
SHOULDER, BERM AND PARKING LANE		
F2.5	Work on berm and/or footpath	Permanent speed less than 65km/h
F2.6	Work in parking lane	Permanent speed less than 65km/h
F2.7	Shoulder closure	
CYCLE LANE		
F2.8	Traffic not crossing road centre	Diverted cycle lane
F2.9	Traffic crossing road centre	Diverted cycle lane - coned lane control
F2.10	Traffic not crossing road centre	Cycle lane closed 
TWO-WAY TWO-LANE ROAD		
F2.11	Traffic not crossing road centre	
F2.12	Traffic not crossing road centre	Signs on median 
F2.13	Traffic crossing road centre	Two-lane diversion
F2.14	Single-lane alternating flow	Manual traffic control (Stop/Go or Stop/Slow)
F2.15	All traffic stopped temporarily	Manual traffic control (Stop/Go or Stop/Slow)
F2.16	Single-lane (traffic volume less than 1000vpd - 80vph)	Give way control
J2.16a	Short no exit road	
F2.17	Single-lane alternating flow	Portable traffic signals 
F2.18	Work in centre of road	
J2.18a	In centre of road with median	Signs on median 

DIAGRAMS LIST

STATIC OPERATIONS

No.	LEVEL 1 ROADS	
TWO-WAY TWO-LANE ROAD		
Intersection or roundabout		
F2.19	Road works on side road after intersection - TSL on side road	Traffic not crossing road centre
J2.19a	Major obstruction close to intersection	Allows shorter sign spacings and MTC operation
F2.20	Road works on side road after intersection - TSL on main road	Traffic not crossing road centre
J2.20a	After intersection - Traffic not crossing road centre	
J2.20b	After intersection - Traffic crossing road centre	
J2.20c	Before intersection - Traffic not crossing road centre	
J2.20d	Before intersection - Traffic crossing road centre	
J2.20e	On median near intersection	
F2.21	Work in middle of intersection	
J2.21a	Work on existing roundabout	
F2.22	Closure at corner of an intersection	Manual traffic control (Stop/Go or Stop/Slow) 
Road closures and detours		
F2.23	Road closure	Temporary route around a hazard or workspace
F2.24	Road closure - detour route	Example 
F2.25	Typical detour route signing	Example 
J2.25a	Partial carriageway closure and detours - One way	Example 
Other hazard		
F2.26	Flooding, washout, slip, slippery surface	
J2.26a	Tree felling	Less than 2 x tree height
J2.26b	Mower and gardening operations	Tree pruning/trimming in berm only
J2.26c	Shelter belt trimming	
Unattended worksites		
F2.27	New seal	Unattended and/or unswept worksite
F2.28	Surface hazard	
J2.28a	Manhole work	
F2.29	Seal repairs on a curve	
ONE-WAY TWO-LANE DIVIDED OR TWO-LANE ROAD		
F2.30	Left-lane closure	
F2.31	Right-lane closure	
F2.32	One-lane closure	Temporary two-lane diversion
F2.33	Lane diversions in both directions	
J2.33a	Lanes diverted	
F2.34	Work in middle of road	
TWO-WAY THREE-LANE ROAD		
F2.35	2 x 1 centre-lane closure	
F2.36	Contraflow lane closure	
TWO-WAY FOUR-LANE ROAD		
F2.37	Left-lane closure	
F2.38	Two-lane closure	One-lane contraflow
F2.39	2 x 2 centre-lane closures	
J2.39a	Right lane closure	
ONE-WAY THREE-LANE DIVIDED OR THREE-LANE ROAD		
F2.40	One-lane closure	Left lane
F2.41	Two-lane closure	Left and centre lanes
J2.41a	Two lane closure	Right and centre lanes
F2.42	Two-lane closure	Two lane temporary diversion
J2.42a	Middle lane closed on roads 50km/h or less	Not for use on state highways 

DIAGRAMS LIST

MOBILE OPERATIONS

No.	LOW-VOLUME ROADS	
TWO-WAY TWO-LANE ROAD		
F3.1	Road inspection activities	
F3.2	Work vehicle is in a lane	With CSD - on LV Low-risk roads (any speed) and LV roads under 65km/h
F3.3	Work vehicle is on berm, shoulder or lane	No CSD
F3.4	Work vehicle on shoulder or berm - clear of live lane	CSD not required

No.	LEVEL 1 ROADS	
TWO-WAY TWO-LANE ROAD		
F4.1	Work vehicle is more than five (5) metres from the edgeline	Any speed
F4.2	Work vehicle is within five (5) metres of the edgeline	CSD to work vehicle: <ul style="list-style-type: none"> ■ not required under 65km/h ■ required over 65km/h
F4.3	Work vehicle is within five (5) metres of the edgeline	Speed limit over 65km/h The rear visibility is less than CSD
F4.4	Work vehicle is in a lane	Permanent speed under 65km/h
F4.5	Work vehicle is in a lane	Permanent speed over 65km/h CSD forward visibility to work vehicle
F4.6	Work vehicle is in a lane	Permanent speed over 65km/h No CSD to work vehicle
F4.7	Personnel on the road	Any speed
ONE-WAY TWO-LANE DIVIDED OR TWO-LANE ROAD		
F4.8	Work vehicle in the right lane	Permanent speed over 65km/h
J4.8a	Personnel on the road	Any speed
F4.9	Part or all of a lane occupied	Semi-static closure – work for up to 1 hour
INSPECTION ACTIVITIES		
J4.10	On shoulder and on the live lane	

READING A TRAFFIC MANAGEMENT DIAGRAM (TMD)







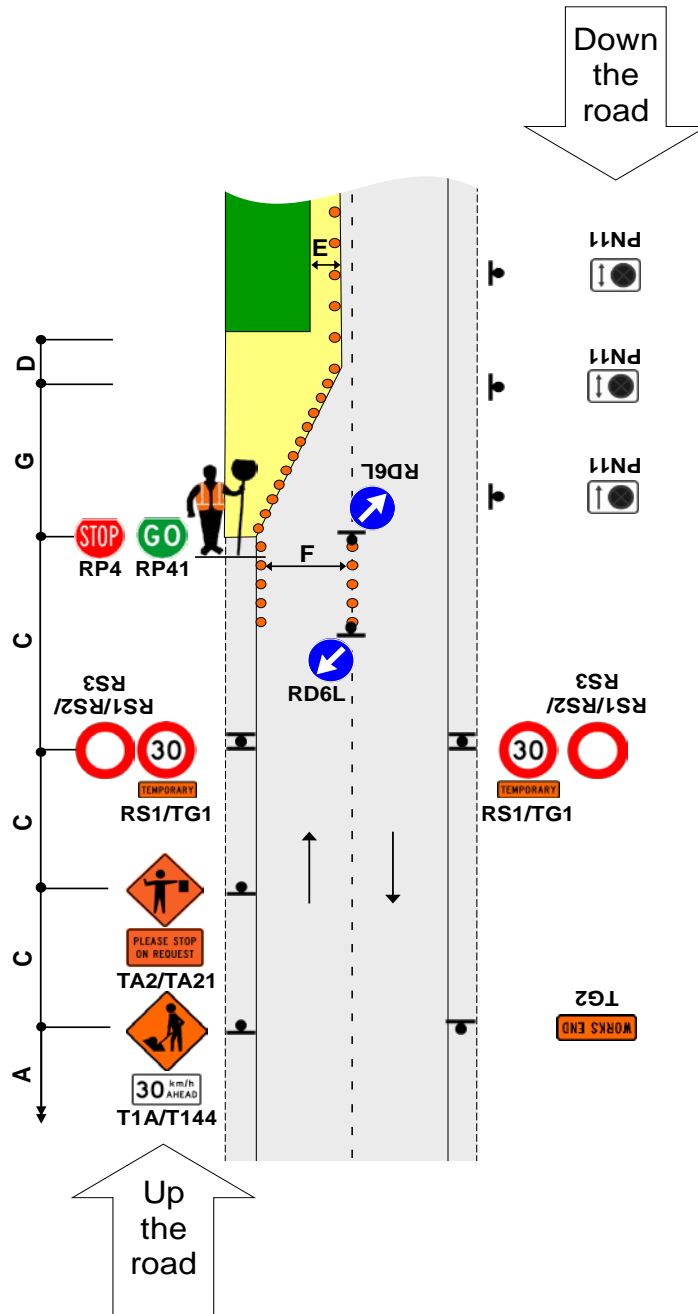



Usually contractors place the signs on left-hand side of the road first with the TMD the right way up. When signs are placed for the right-hand side of the road the contractor tips the TMD upside down and reads which signs have to be placed for that side of the road.

To make this process easier:

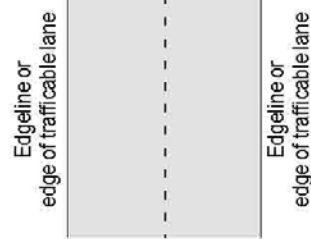
- Signs going up the page are shown closest to the road
- Signs going down the page are shown further away from the road
- Sign icons and sign numbers for layout down the road (from top to bottom of the TMD) are turned upside down.

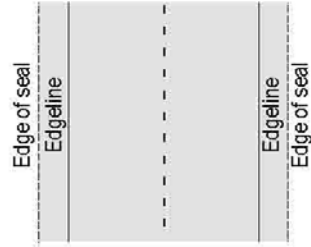

LEGEND FOR DIAGRAMS

<p>Working space</p> 	<p>Mandatory:</p> <ul style="list-style-type: none"> • Cones • Signs 
<p>Safety zones</p> 	<p>Optional:</p> <ul style="list-style-type: none"> • Cones • Signs 
<p>Edgeline or edge of trafficable lane (indicated by solid black line)</p> 	<p>Hazard area</p> 
	<p>Manhole</p> 
<p>Edge of seal (indicated by dotted line next to solid black line)</p> 	<p>Barrier, safety fence or cone bars</p> 
	<p>Ramp</p> 
<p>If the STMS has been delegated self-approval of TMPs by the RCA, this TMD must be referred to the TMC for approval</p> 	

LEVEL LV LAYOUT DISTANCES TABLE

Permanent speed limit or RCA-designated operating speed (km/h)		≤50	60	70	80	90	100		
Traffic signs									
A	Sign visibility distance (m)	50	60	70	80	90	100		
B	Warning distance (m)	50 or 30*	80	105	120	135	150		
C	Sign spacing (m)	25 or 15*	40	50	60	70	75		
Safety zones									
D	Longitudinal (m)	0	0	0	0	0	0		
E	Lateral (m) ⁺	1	1	1	1	1	1		
Tapers									
G	Taper length (m) [#]	25	30	35	40	45	50		
Delineation devices									
Cone spacing in taper (m)		2.5	2.5	5	5	5	5		
Cone spacing: working space (m)		10	10	20	20	20	20		
<p>* Larger minimum distances apply on all state highways. The smaller minimum distances may be applied on other roads to accommodate road environment constraints.</p> <p>+ On LV roads, the lateral safety zone may be reduced or eliminated in order to retain a single lane width. Positive traffic management and an appropriate TSL must be used.</p> <p># On non-state highways with permanent speeds 50km/h or less, a 10m taper (with cones at 1m centres) may be used when there are road environment constraints (eg intersections and commercial accesses).</p> <p>On all roads where shoulder width is less than 2.5m and the activity does not affect the live lane, a 10m shoulder taper is permitted (with at least 5 cones at no greater than 2.5m centres).</p> <p>A taper of 30m (with cones at 2.5m centres) must be used where manual traffic control (stop/go), portable traffic signals or priority give way are employed.</p>									
Lane widths									
Speed (km/h)		30	40	50	60	70	80	90	100
F	Lane width (m)	2.75	2.75	3.0	3.0	3.25	3.25	3.5	3.5

Except for delineation device spacings, which are maximum values, the distances specified in the above tables are minimum values.

LV/low-risk roads

Working on roads designated as LV/low risk (less than 250 vehicles per day (vpd) - less than 20 vehicles per hour), with clear sight distance to the operation and an operating speed of less than 65km/h:

- use an appropriate advance warning sign (static installation) and amber flashing beacon on working vehicle when on the shoulder
- consider stop/go or give way control of traffic when activity encroaches onto lane.

If the above requirements cannot be achieved, the operation must be modified to comply with the requirements of a higher risk rating.

LEVEL 1 LAYOUT DISTANCES TABLE

Permanent speed limit or RCA-designated operating speed (km/h)		≤50	60	70	80	90	100		
Traffic signs									
A	Sign visibility distance (m)	50	60	70	80	90	100		
B	Warning distance (m)	50 or 30*	80	105	120	135	150		
C	Sign spacing (m)	25 or 15*	40	50	60	70	75		
Safety zones									
D	Longitudinal (m)	10 or 5*	15	30	45	55	60		
E	Lateral (m)	1	1	1	1	1	1		
Tapers									
G	Taper length (m) [#]	30	50	70	80	90	100		
K	Distance between tapers (m)	40	50	70	80	90	100		
Delineation devices									
Cone spacing in taper (m)		2.5	2.5	5	5	5	5		
Cone spacing: Working space (m)		5	5	10	10	10	10		
<p>* Larger minimum distances apply on all state highways and also on all multi-lane roads. The smaller minimum distances may be applied on other roads to accommodate road environment constraints.</p> <p># On non-state highways with speeds 50km/h or less, a 10m taper (with cones at 1m centres) may be used when there are road environment constraints (eg intersections and commercial accesses). On all roads where shoulder width is less than 2.5m and the activity does not affect the live lane, a 10m shoulder taper is permitted (with at least 5 cones at no greater than 2.5m centres). A taper of 30m (with cones at 2.5m centres) must be used where manual traffic control (stop/go), portable traffic signals or priority give way are employed.</p>									
Lane widths									
Speed (km/h)		30	40	50	60	70	80	90	100
F	Lane width (m)	2.75	2.75	3.0	3.0	3.25	3.25	3.5	3.5

Except for delineation device spacings, which are maximum values, the distances specified in the above tables are minimum values.

COMBINED LEVEL LV & LEVEL 1 LAYOUT DISTANCES TABLE

Permanent speed limit or RCA-designated operating speed (km/h)		≤50	60	70	80	90	100		
Traffic signs									
A	Sign visibility distance (m)	50	60	70	80	90	100		
B	Warning distance (m)	50 or 30*	80	105	120	135	150		
C	Sign spacing (m)	25 or 15*	40	50	60	70	75		
Safety zones									
D	Longitudinal (m) ⁺	10 or 5*	15	30	45	55	60		
E	Lateral (m) ⁺	1	1	1	1	1	1		
Tapers									
G	Taper length (m) [#]	30	50	70	80	90	100		
G	LV roads taper length (m) [#]	25	30	35	40	45	50		
K	Distance between tapers (m)	40	50	70	80	90	100		
Delineation devices									
Cone spacing in taper (m)		2.5	2.5	5	5	5	5		
Cone spacing: Working space (m) ^{##}		5	5	10	10	10	10		
<p>* Larger minimum distances apply on all state highways and also on all multi-lane roads. The smaller minimum distances may be applied on other roads to accommodate road environment constraints.</p> <p>+ On LV roads the longitudinal and lateral safety zones may be reduced, or eliminated, in order to retain a single lane width. Positive traffic management and an appropriate TSL must be used.</p> <p># On non-state highways with speeds 50km/h or less, a 10m taper (with cones at 1m centres) may be used when there are road environment constraints (eg intersections and commercial accesses).</p> <p>On all roads where shoulder width is less than 2.5m and the activity does not affect the live lane, a 10m shoulder taper is permitted (with at least 5 cones at no greater than 2.5m centres).</p> <p>A taper of 30m (with cones at 2.5m centres) must be used where manual traffic control (stop/go), portable traffic signals or priority give way are employed.</p> <p>## LV roads: double the cone spacing alongside working space (eg 5 = 10, 10 = 20).</p>									
Lane widths									
Speed (km/h)		30	40	50	60	70	80	90	100
F	Lane width (m)	2.75	2.75	3.0	3.0	3.25	3.25	3.5	3.5

Except for delineation device spacings, which are maximum values, the distances specified in the above tables are minimum values.

LV/low risk roads

Working on roads designated as LV/low-risk roads (less than 250vpd - less than 20 vehicles per hour), with clear sight distance to the operation and an operating speed of less than 65km/h:

- use an appropriate advance warning sign (static installation) and amber flashing beacon(s) on working vehicle when on the shoulder
- consider stop/go or give way control of traffic when activity encroaches onto lane.

If the above requirements cannot be achieved, the operation must be modified to comply with the requirements of a higher risk rating.

Notes

1. Cone spacing along side of working space on roads:
 - over 65km/h = 20m
 - under 65km/h = 10m
2. A 10m taper is allowed where shoulder width is less than 2.5m
3. *For shoulders exceeding 2.5m width, apply the following calculation; calculation of taper length for lateral shift of less than 3.5m is:

$$W \times G$$

$$3.5$$

W = Width of shoulder
 G = Taper length in metres from the level LV layout distance table

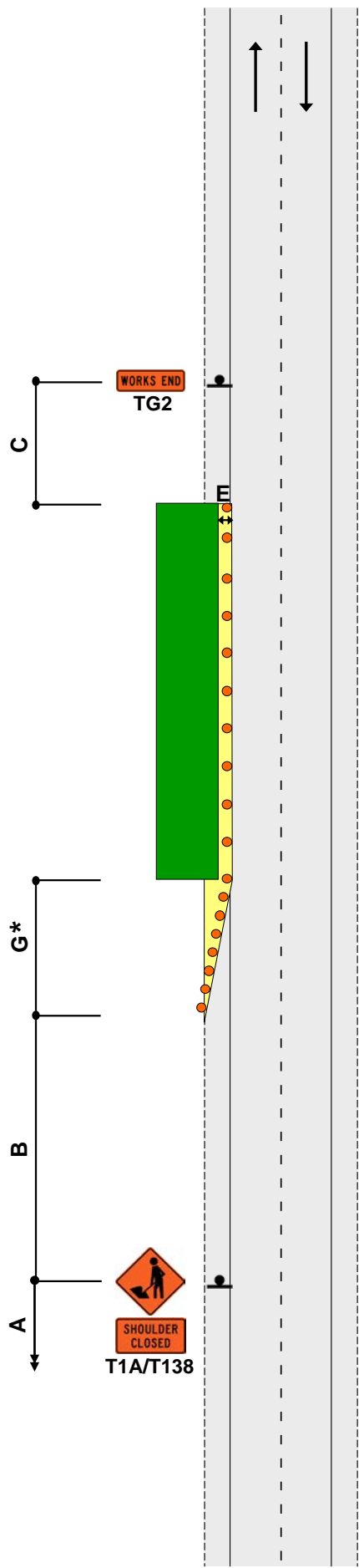

STATIC OPERATIONS

SHOULDER AND BERM
Shoulder closure - low-risk (under 250vpd)

Low-risk
Under 250vpd

F1.2
Level LV

Notes

- 1. Advance warning sign may be attached to rear of work vehicle if sign visibility is available

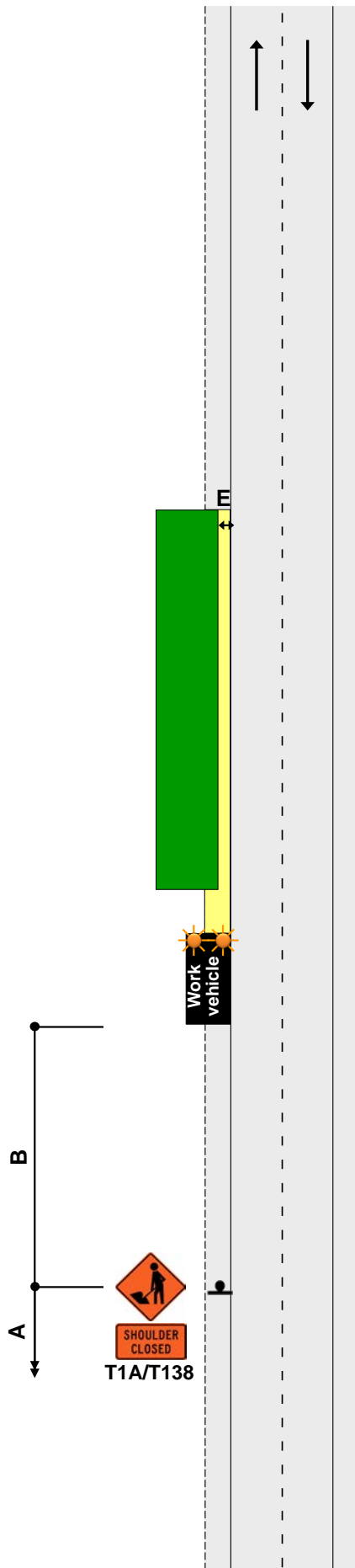

STATIC OPERATIONS

TWO-WAY TWO-LANE ROAD

Lane closure
Under 65km/h - must have CSD in both directions

Low-risk
Under 250vpd

F1.3
Level LV

Notes

1. Advance warning sign may be attached to rear of work vehicle if sign visibility is available
2. Where advance warning signs are used on both approaches, end of works signs may be mounted on the rear of the advance warning signs
3. If the working space is very short (less than 30m) then one MTC operating in the middle of the worksite may be used
4. Minimum 5 cones in cone threshold at:
 - 2.5m centres - less than 65km/h
 - 5m centres - more than 65km/h
5. STOP/GO control may be replaced by GIVE WAY control
6. For closures of more than 1 day at same location use diagram F1.5 or similar

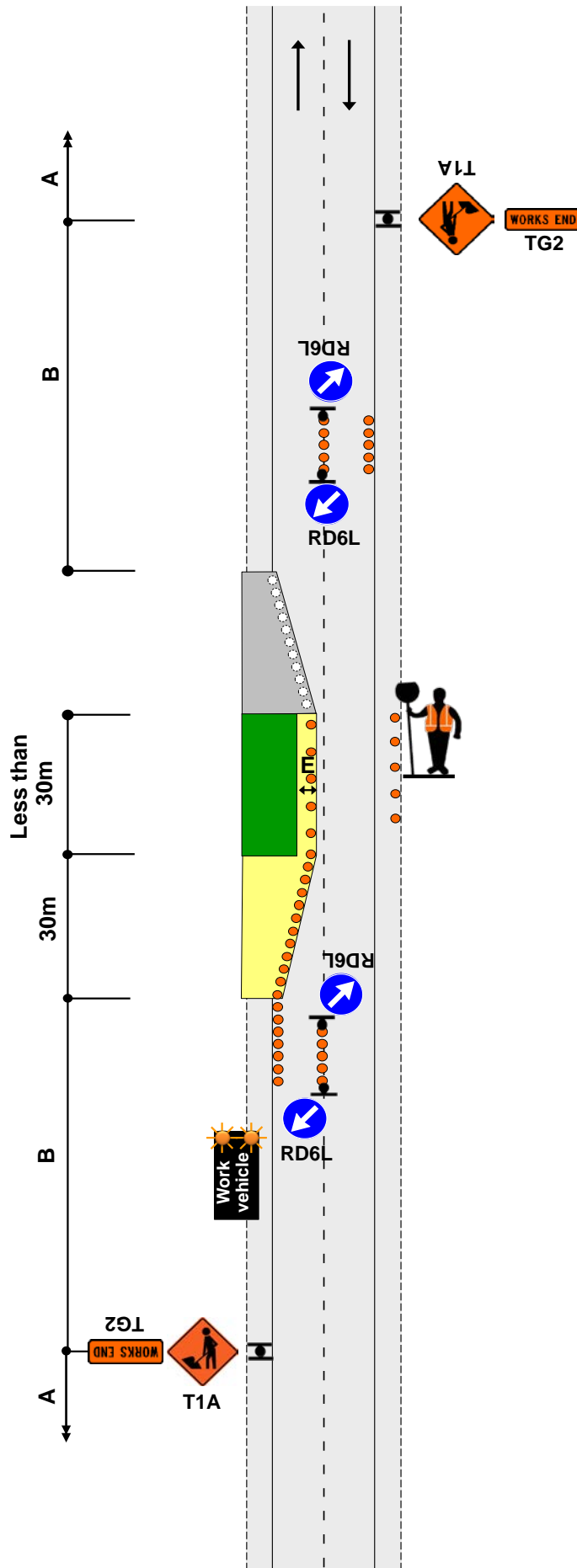

TWO-WAY TWO-LANE ROAD

All traffic stopped temporarily

Manual traffic control

F1.4
Level LV

Notes

1. Temporary delay period not to exceed the limit set or approved by the RCA
2. MTC with RP4/RP41 STOP/GO or RP4/RP42 STOP/SLOW paddle on road shoulder located between 1st and 2nd cone in the cone threshold closest to the working space
3. Minimum 5 cones in cone threshold at:
 - 2.5m centres - less than 65km/h
 - 5m centres - more than 65km/h
4. MTCs must show same message to oncoming traffic (eg STOP/STOP or GO/GO)
5. Refer to C10.2.3 MTC essentials for further information
6. Traffic must be temporarily stopped in both directions of travel where the width of road is too narrow to cater for:
 - the work
 - delineation
 - safety zones, and
 - road user traffic

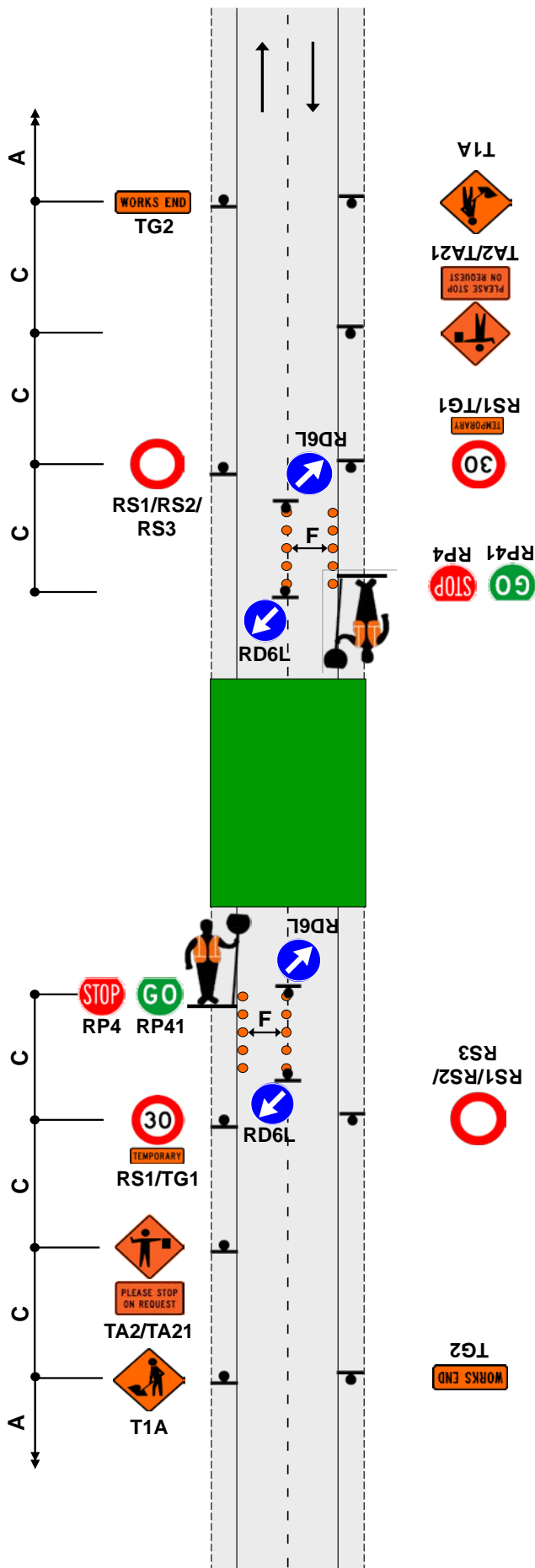

TWO-WAY TWO-LANE ROAD
Single-lane alternating flow
Manual traffic control

F1.5
Level LV

Notes

1. Temporary delay period not to exceed the limit set or approved by the RCA
2. A 30m return taper at the end of the closure is optional
3. MTC with RP4/RP41 STOP/GO or RP4/RP42 STOP/SLOW paddle on road shoulder located between 1st and 2nd cone in the cone threshold closest to the working space
4. Minimum 5 cones in cone threshold at:
 - 2.5m centres - less than 65km/h
 - 5m centres - more than 65km/h
5. When road users are passing the working space in alternating flow, all construction equipment must be stopped on same side of the road if there is no separation from the live lane
6. Refer to C10.2.3 MTC essentials for further information

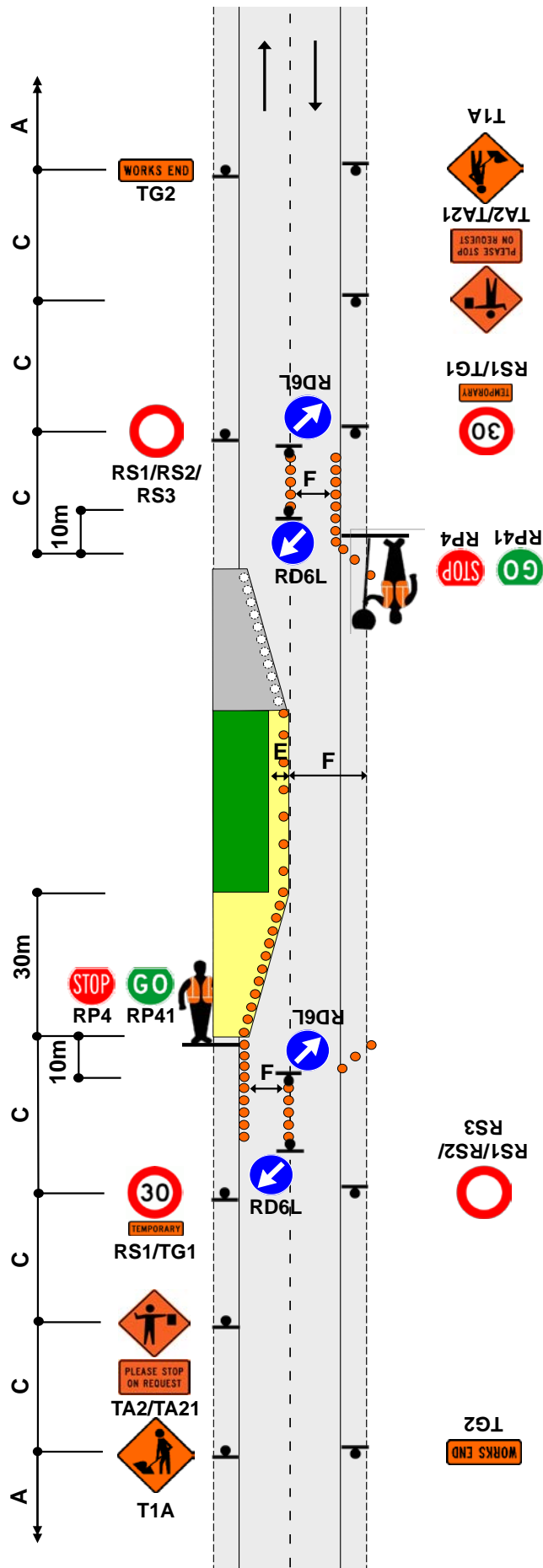

TWO-WAY TWO-LANE ROAD
Single-lane alternating flow
Portable traffic signals

F1.6
Level LV

Notes

1. Use a full TMP form for this operation as it includes details of the portable traffic signals to be used
2. Install temporary limit lines or use RP61/RP62 signs



3. A 30m return taper at the end of the closure is optional
4. Minimum 5 cones in cone threshold at:
 - 2.5m centres - less than 65km/h
 - 5m centres - more than 65km/h

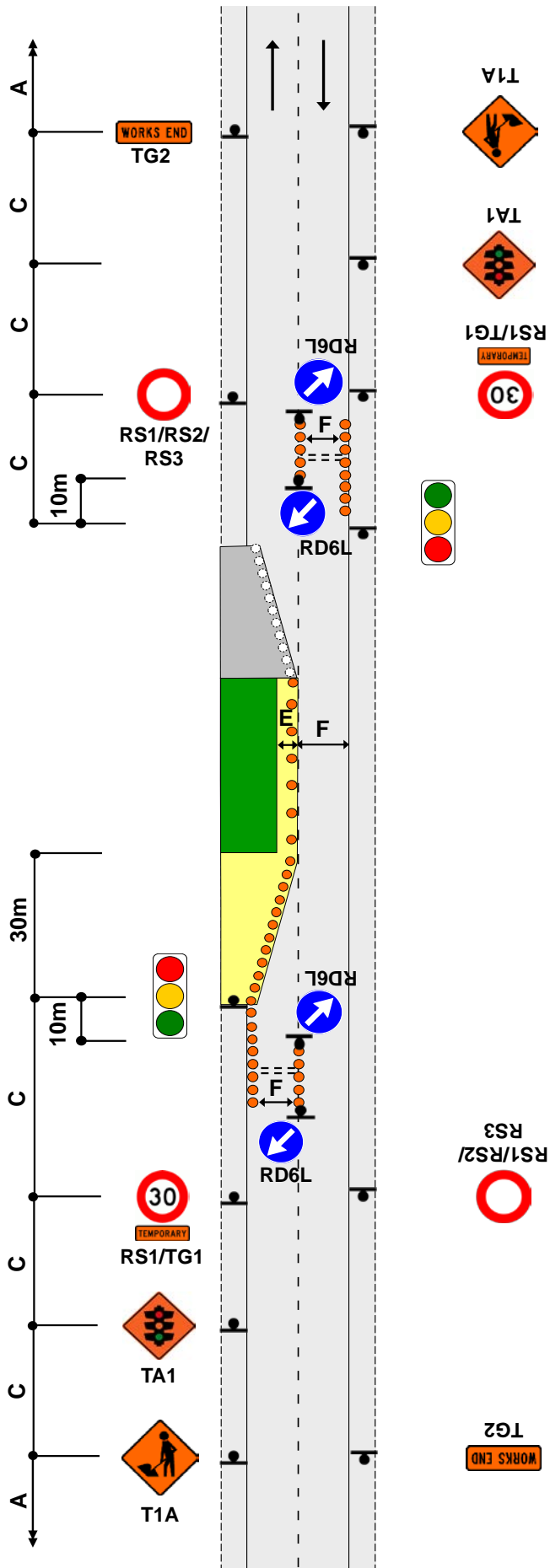

TWO-WAY TWO-LANE ROAD

Single-lane
Give way control

F1.7
Level LV

Notes

- The RP51/RP22 and RP55 controls must be placed in the following priority order:
 - downhill traffic must give way to uphill traffic
 - traffic that has to cross into the opposing lane gives way
- RS1/TG1 TSL signs and RS1/RS2/RS3 TSL derestriction signs may be installed if required
- Working space to be less than 100m
- Intervisibility is required as indicated on diagram. This means that a road user stopped at one priority sign has unimpeded line of sight to a road user at the other priority sign
- A 30m return taper at the end of the closure and cones on the centre line are optional

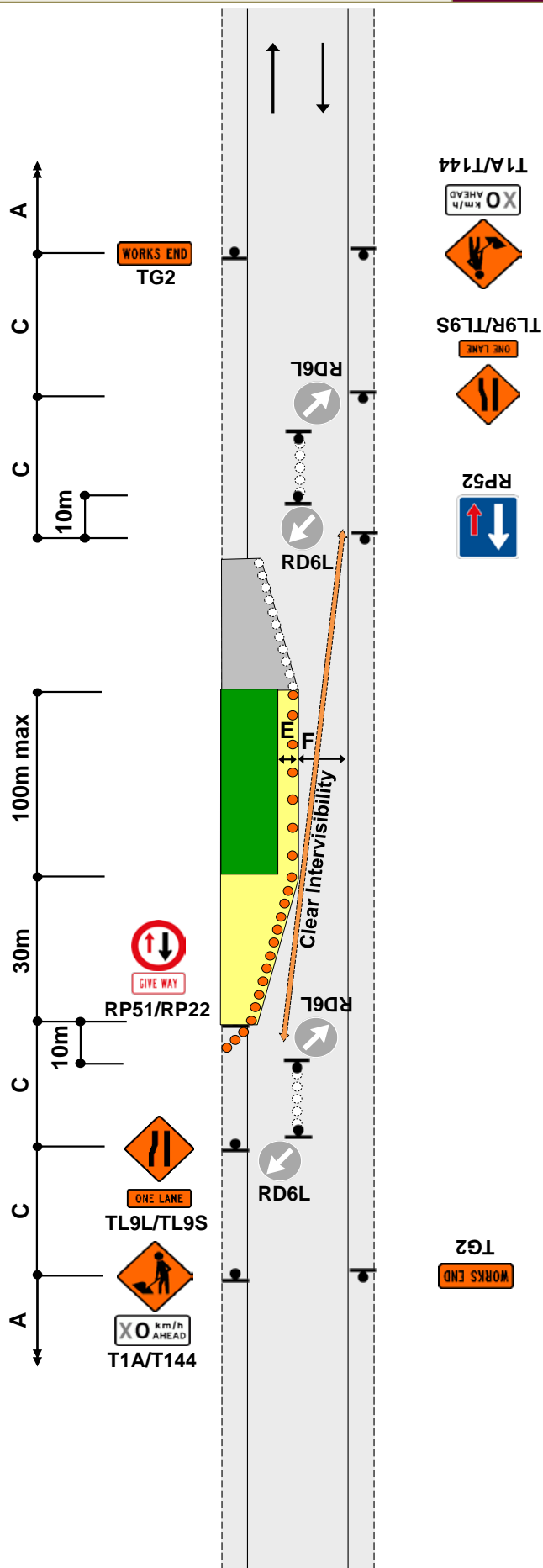

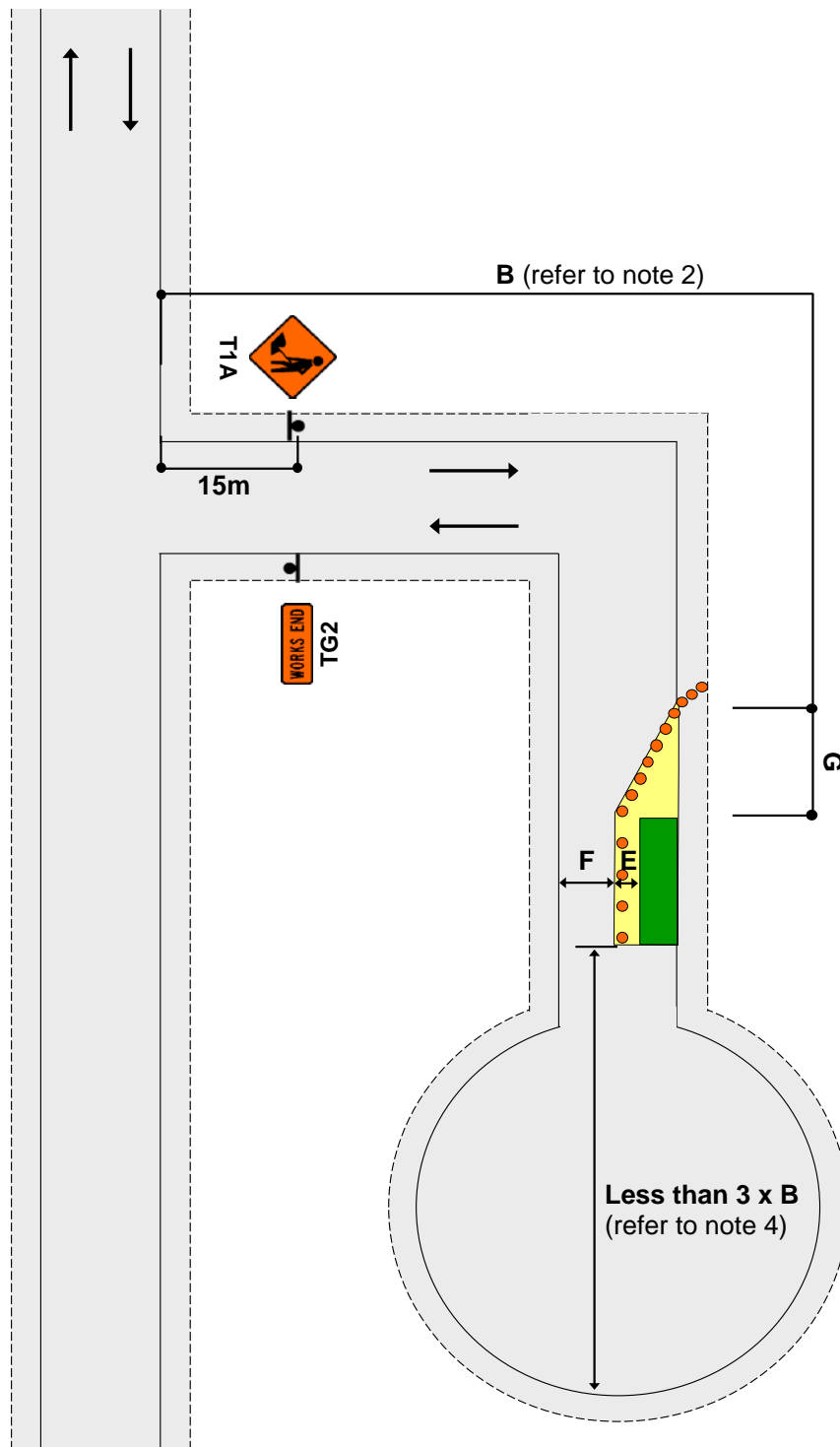

Notes

1. T1A sign to be placed at least 15m from the intersection
2. Where less than B, T1A/T135 and TG2 signs required on main road
3. Working space to be less than 100m
4. Signage is not required past the worksite where there is less than 3 x B from the end of the working space to the end of the road

FOOTPATH

Footpath diverted onto berm behind working space

First preference

F2.1
Level 1

Notes

1. Minimum pedestrian footpath widths:
 - Residential/Rural - 0.9m
 - Suburban Centre - 1.2m
 - CBD - 2m
2. Where the length of the working space exceeds 20m, these widths may have to be increased so footpath users do not have to wait to pass
3. Temporary footpath surfaces must be suitable for footpath users
4. Use safety fence to enclose the working space, or at **attended** worksites, cones connected with cone bars can be used to enclose the working space but only for a short period of time

Note: Cone bars are not recommended where heavy equipment (eg a digger) is being used. A safety fence is preferred in these cases
5. This TMD must be used in conjunction with appropriate TTM for any work carried out on the shoulder or in the live lane

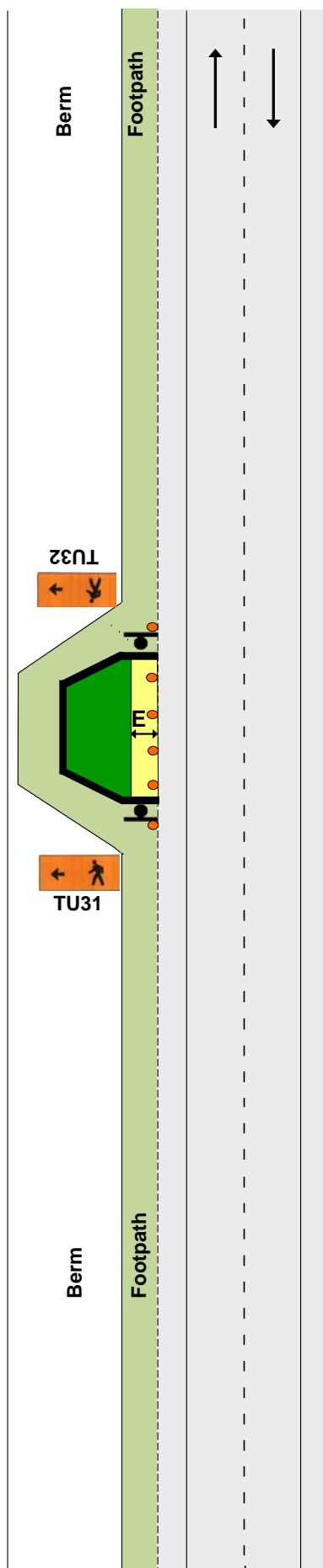

FOOTPATH

Footpath diverted onto berm between working space and carriageway
Second preference

F2.2
Level 1

Notes

1. Minimum pedestrian footpath widths:
 - Residential/Rural - 0.9m
 - Suburban Centre - 1.2m
 - CBD - 2m
2. Where the length of the working space exceeds 20m, these widths may have to be increased so footpath users do not have to wait to pass
3. Temporary footpath surfaces must be suitable for footpath users
4. Use safety fence to enclose the working space, or at **attended** worksites, cones connected with cone bars can be used to enclose the working space but only for a short period of time
Note: Cone bars are not recommended where heavy equipment (eg a digger) is being used. A safety fence is preferred in these cases
5. Use barrier or safety fence to delineate the traffic side of the footpath, or at **attended** worksites (except on state highways) cones connected with cone bars can be used to delineate the traffic side of the footpath for a short period of time
6. There must be a lateral safety zone between the traffic side of the footpath and the live lane:
 - **0.5m** for barrier
 - **1m** for safety fence or cone bars
7. This TMD must be used in conjunction with appropriate TTM for any work carried out on the shoulder or in the live lane

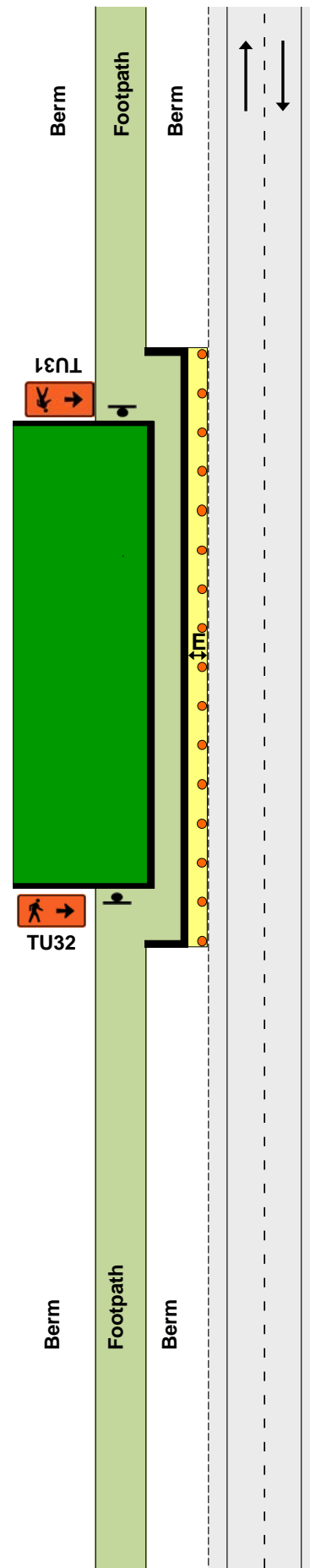

FOOTPATH

Footpath diverted onto carriageway

Third preference

Notes

1. Minimum pedestrian footpath widths:
 - Residential/Rural - 0.9m
 - Suburban Centre - 1.2m
 - CBD - 2m
2. Where the length of the temporary footpath exceeds 20m, these widths may have to be increased so footpath users do not have to wait to pass
3. Use safety fence to enclose the working space, or at **attended** worksites, cones connected with cone bars can be used to enclose the working space but only for a short period of time
Note: Cone bars are not recommended where heavy equipment (eg a digger) is being used. A safety fence is preferred in these cases
4. Use barrier or safety fence to delineate the traffic side of the footpath, or at **attended** worksites (except on state highways) cones connected with cone bars can be used to delineate the traffic side of the footpath for a short period of time
5. There must be a lateral safety zone between the traffic side of the footpath and the live lane:
 - 0.5m for barrier
 - 1m for safety fence or cone bars
6. Use kerb ramps to assist mobility vehicles, pushchairs, etc
7. At night-time, corners of safety fence may be illuminated with flashing amber warning lights
8. This TMD must be used in conjunction with appropriate TTM for any work carried out on the shoulder or in the live lane

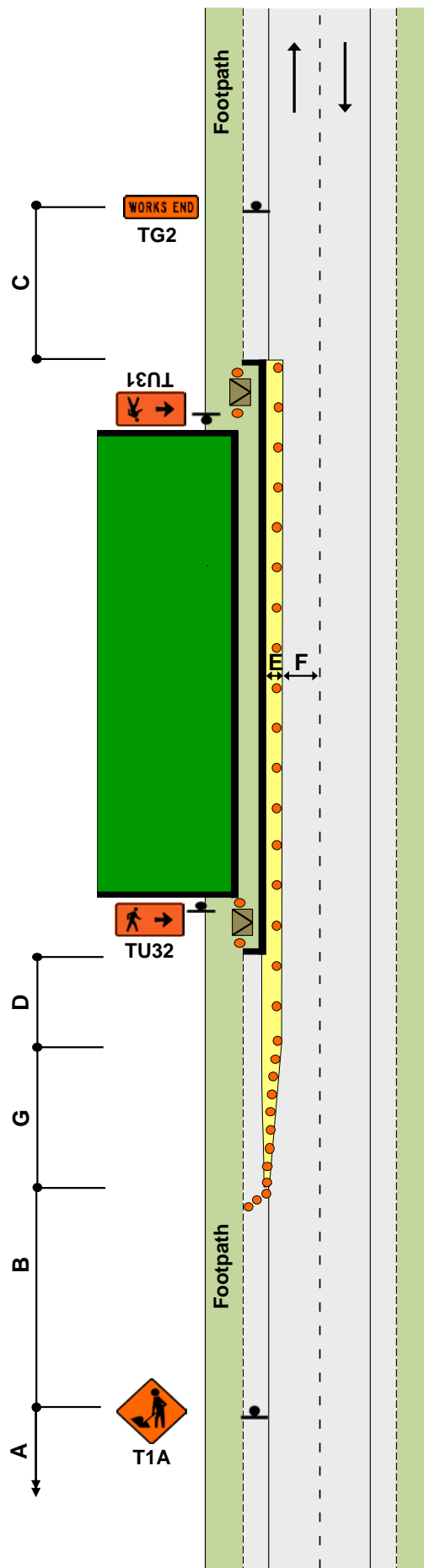

FOOTPATH

Footpath closed - permanent speed less than 65km/h

Fourth preference

F2.4
Level 1

Notes

1. Use T2A and PEDESTRIANS supplementary plate to alert road users to the potential of footpath users crossing the carriageway
2. Use safety fence at each end of working space
3. Use kerb ramps
4. Use another TMD as well, where working space/safety zone encroaches on live lane
5. This TMD must be used in conjunction with appropriate TTM for any work carried out on the shoulder or in the live lane

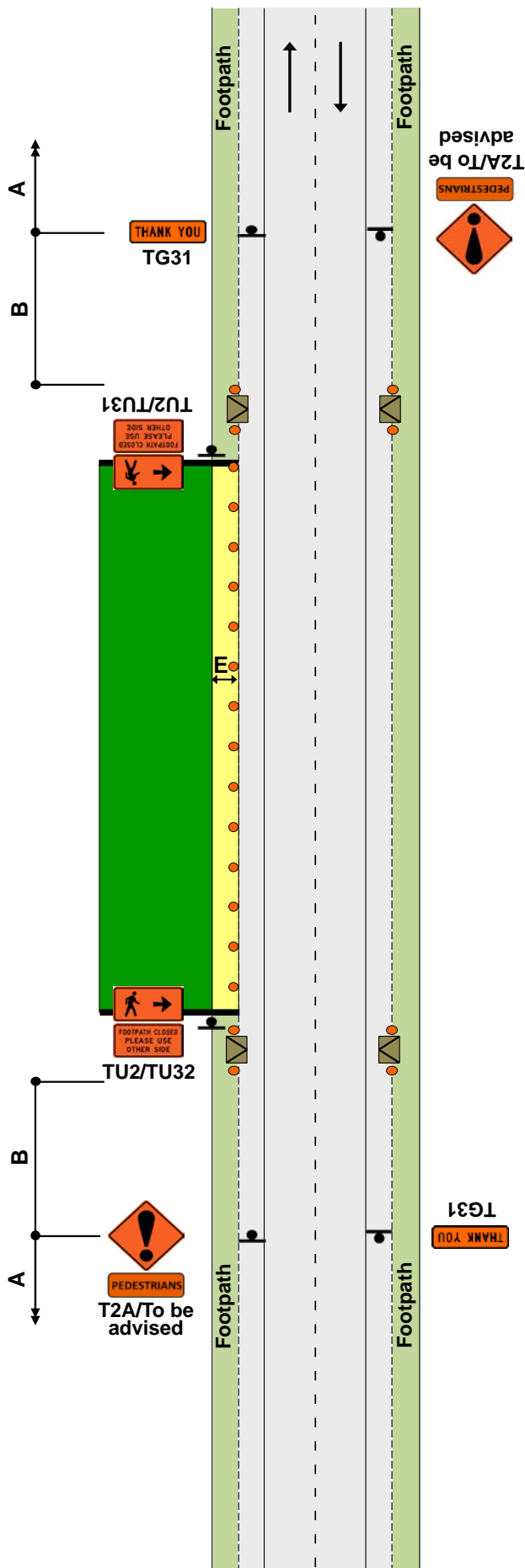

SHOULDER, BERM AND PARKING LANE

Work on berm and/or footpath

Permanent speed less than 65km/h

F2.5
Level 1

Notes

1. Where work is carried out on the berm or footpath and a work vehicle is parked in a legal parallel car park, provided the vehicle is only accessed from the off traffic side, advance warning T1A and WORKS END TG2 are optional
2. Traffic management must be provided where footpath users or cyclists are affected
3. This layout may only be used during daylight hours
4. Large plant and machinery must not be used in this situation, a more substantial closure is required

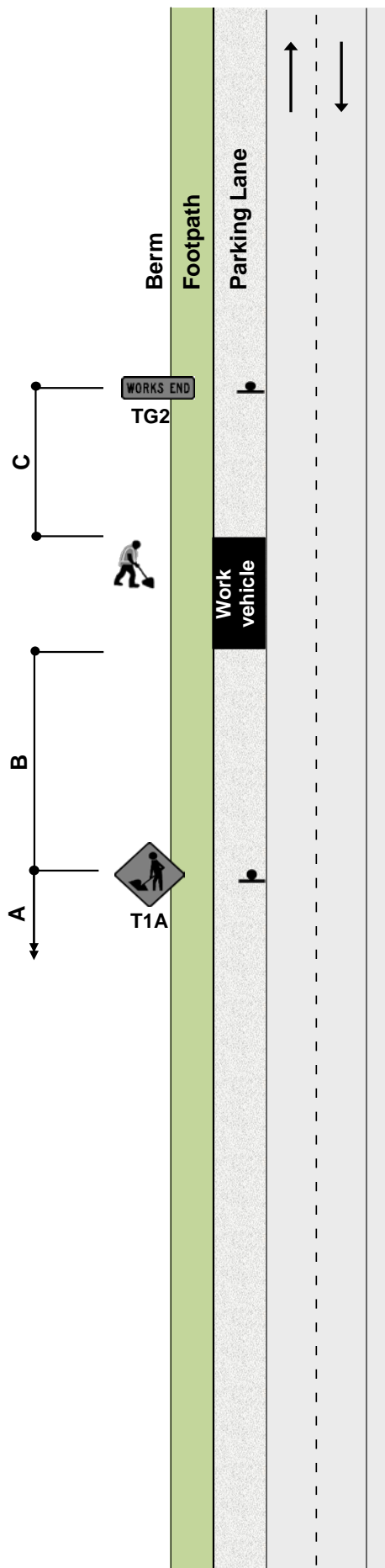

SHOULDER, BERM AND PARKING LANE

Work in parking lane

Permanent speed less than 65km/h

F2.6
Level 1

Notes

1. Where work is carried out in the legal parking lane (a place where a vehicle would normally park with a footpath and/or kerb and channel alongside), the following minimum standard of TTM must be provided:
 - a 10m taper in front of the work vehicle
 - cones alongside the work vehicle and the working space
 - a longitudinal safety zone
 - a 1m lateral safety zone along the working space
 - a T1A (or other appropriate advance warning sign) mounted on the back of the work vehicle
2. T1A ROAD WORKS and TG2 WORKS END signs are optional
3. The work vehicle must be no larger than a light truck and may have an amber flashing beacon
4. Traffic management must be provided where footpath users or cyclists are affected
5. This layout may only be used during daylight hours
6. Large plant and machinery must not be used in this situation, a more substantial closure is required

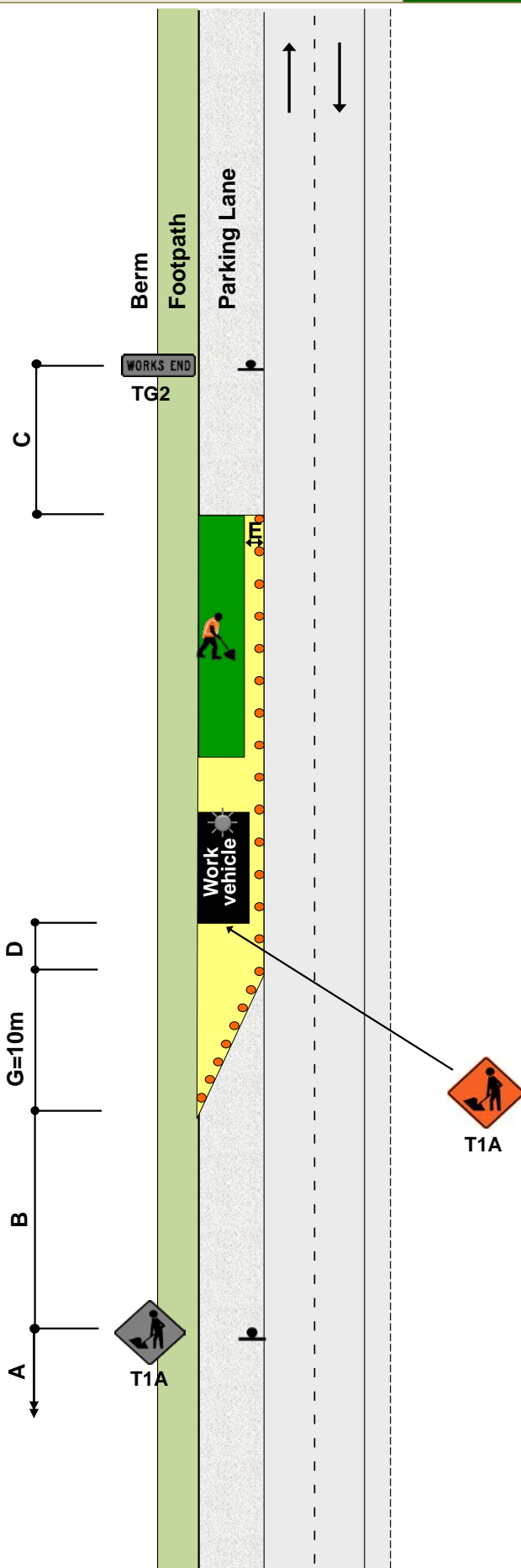

Notes

1. A 10m taper is allowed where shoulder width is less than 2.5m
2. *For shoulders exceeding 2.5m width, apply the following calculation;

$$\frac{W \times G}{3.5}$$

3.5

W = Width of shoulder

G = Taper length in metres from the level 1 layout distance table

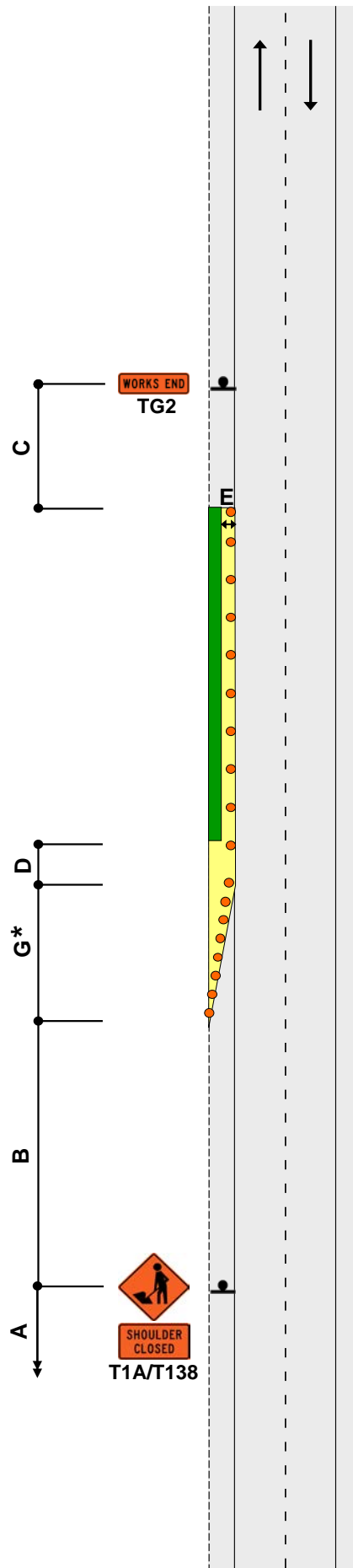

CYCLE LANE

Traffic not crossing road centre
Diverted cycle lane

F2.8

Level 1

Notes

- Minimum cycle lane width must be:
 - 1m - 50km/h or less
 - 1.5m - 60km/h or more
- A minimum cycle lane width of 1.5m is required if the temporary cycle lane is uphill
- *Calculation of taper length for lateral shift of less than 3.5m is:

$$\frac{W \times G}{3.5}$$

W = Width of lateral shift
 G = Taper length in metres from the level 1 layout distance table
- Use TSLs if required by TSL decision matrix
- The T144 X0km/h AHEAD sign is optional

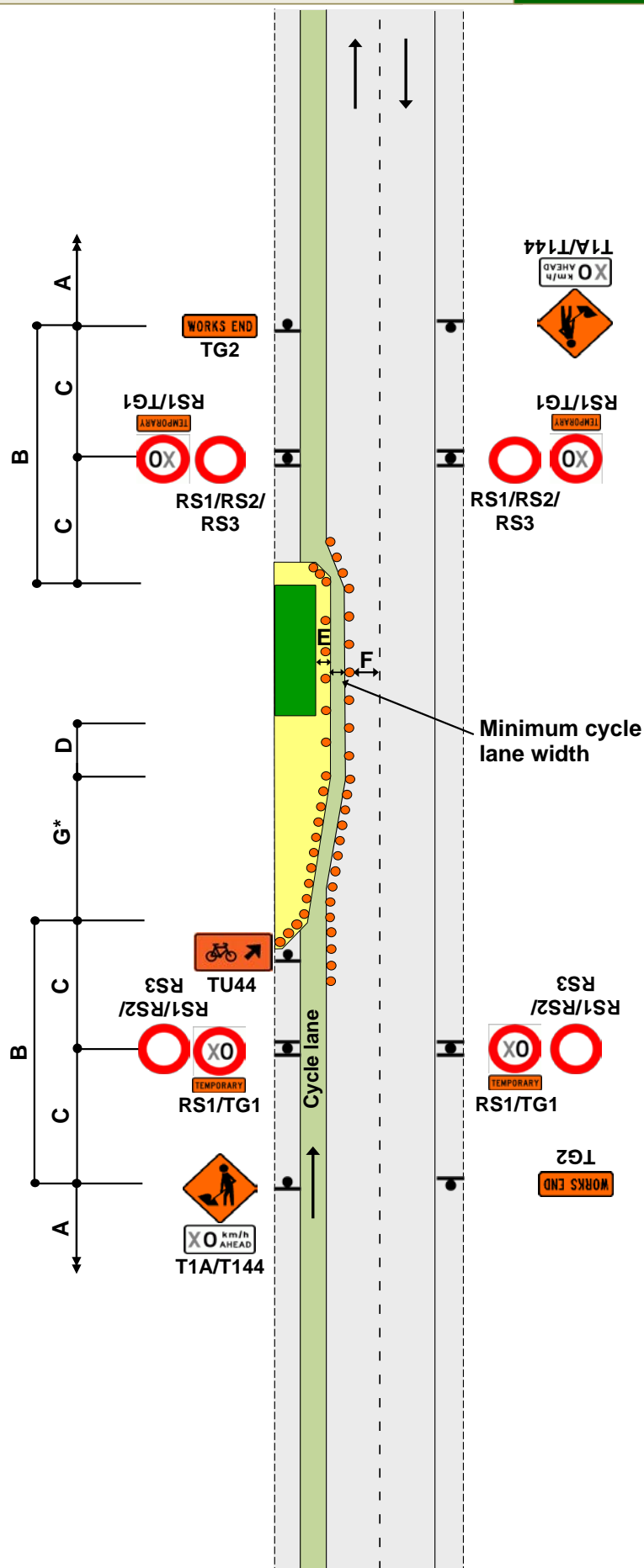

CYCLE LANE

Traffic crossing road centre
 Diverted cycle lane - coned lane control

F2.9

Level 1

Notes

- Minimum cycle lane width must be:
 - 1m - 50km/h or less
 - 1.5m - 60km/h or more
- A minimum cycle lane width of 1.5m is required if the temporary cycle lane is uphill
- *Calculation of taper length for lateral shift of less than 3.5m is:

$$\frac{W \times G}{3.5}$$

W = Width of lateral shift
 G = Taper length in metres from the level 1 layout distance table
- To allow heavy vehicles to manoeuvre, cones in the channel must be offset by at least 10m where the direction changes. Refer C8.2.12
- Use TSLs if required by TSL decision matrix
- The T144 X0km/h AHEAD sign is optional

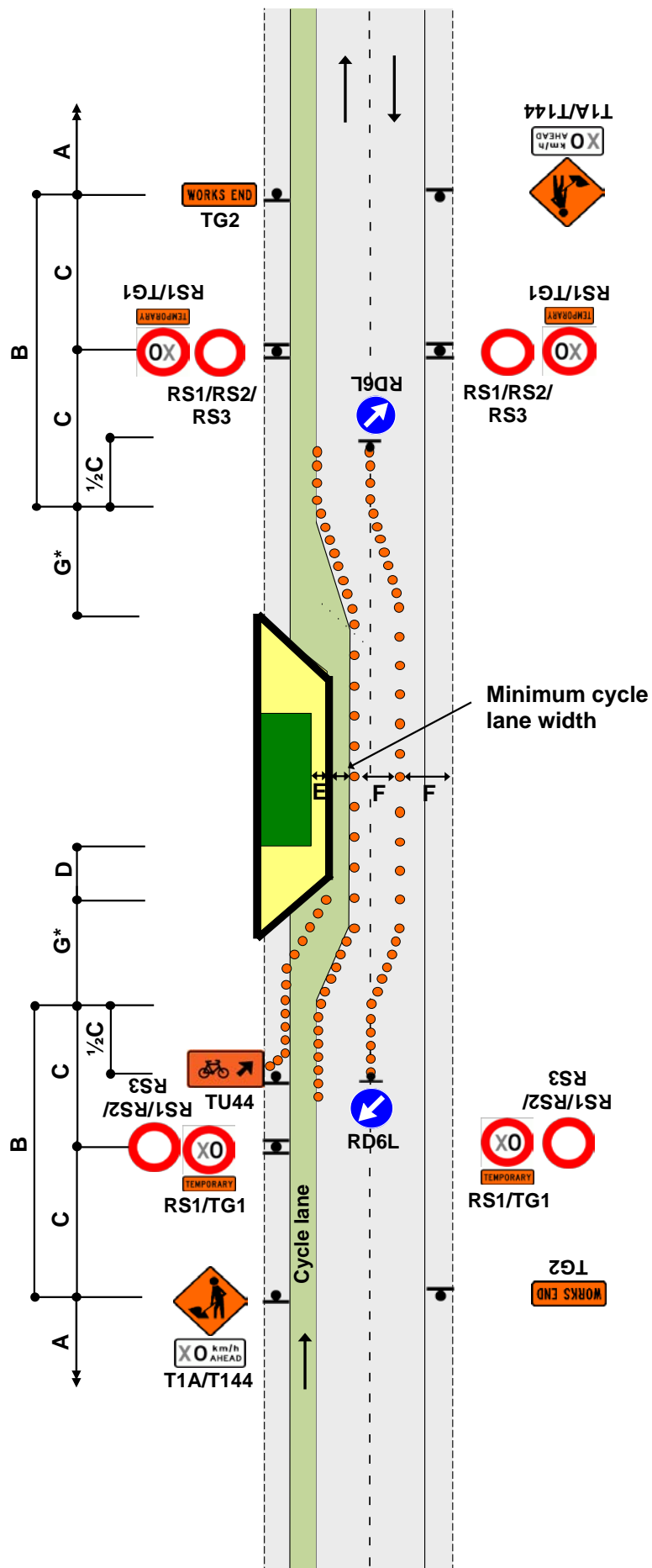

CYCLE LANE
Traffic not crossing road centre
Cycle lane closed

F2.10
Level 1

Notes

1. Only use this TMD if there is insufficient width to fit a replacement cycle lane
2. Minimum cycle lane width must be:
 - 1m - 50km/h or less
 - 1.5m - 60km/h or more
3. A minimum cycle lane width of 1.5m is required if the temporary cycle lane is uphill
4. Merge of cycle lane with live lane must be delineated
5. *Calculation of taper length for lateral shift of less than 3.5m is:

$$\frac{W \times G}{3.5}$$

W = Width of lateral shift
 G = Taper length in metres from the level 1 layout distance table
6. The T144 30km/h AHEAD sign is optional

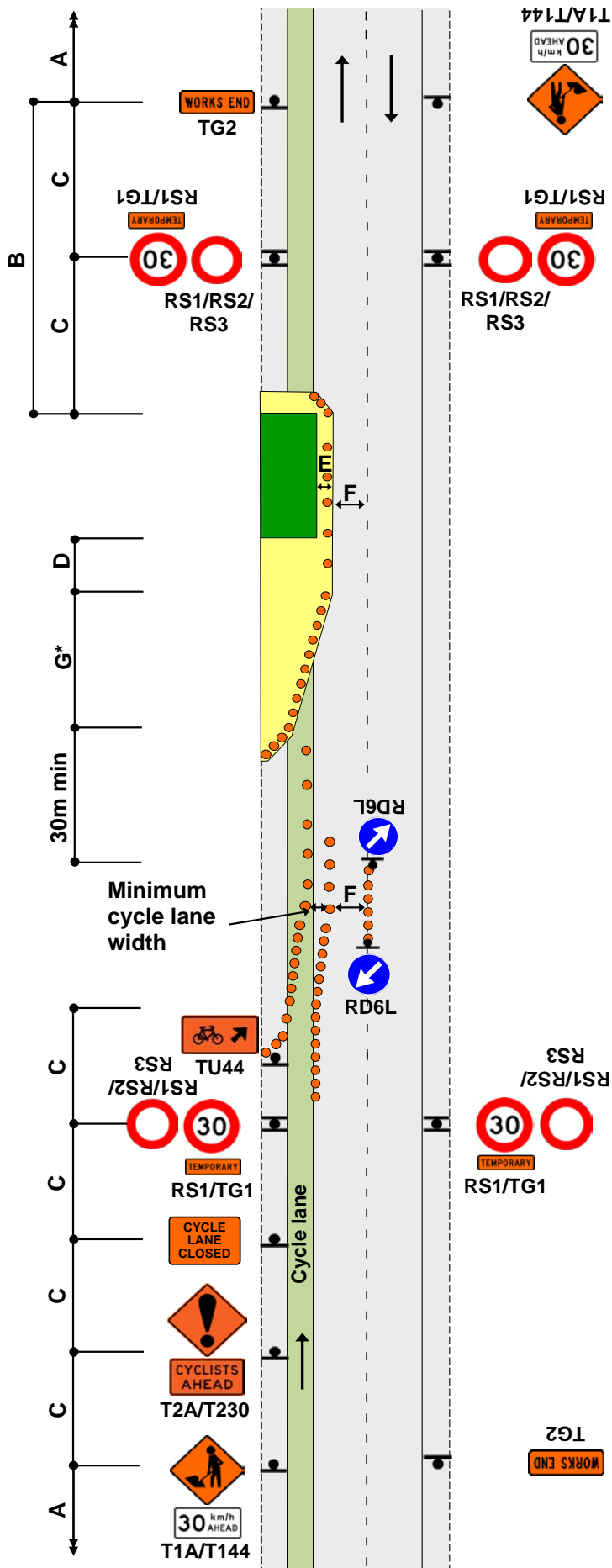

Notes

- *Calculation of taper length for lateral shift of less than 3.5m is:
$$\frac{W \times G}{3.5}$$

W = Width of lateral shift
G = Taper length in metres from the level 1 layout distance table
- If traffic likely to cross the centreline, place cones on the centreline with RD6L signs at each end
- Use TSLs if required by TSL decision matrix
- If TSLs not required, the T1A and TG2 signs on the right hand side of the road are also not required
- The T144 X0km/h AHEAD sign is optional

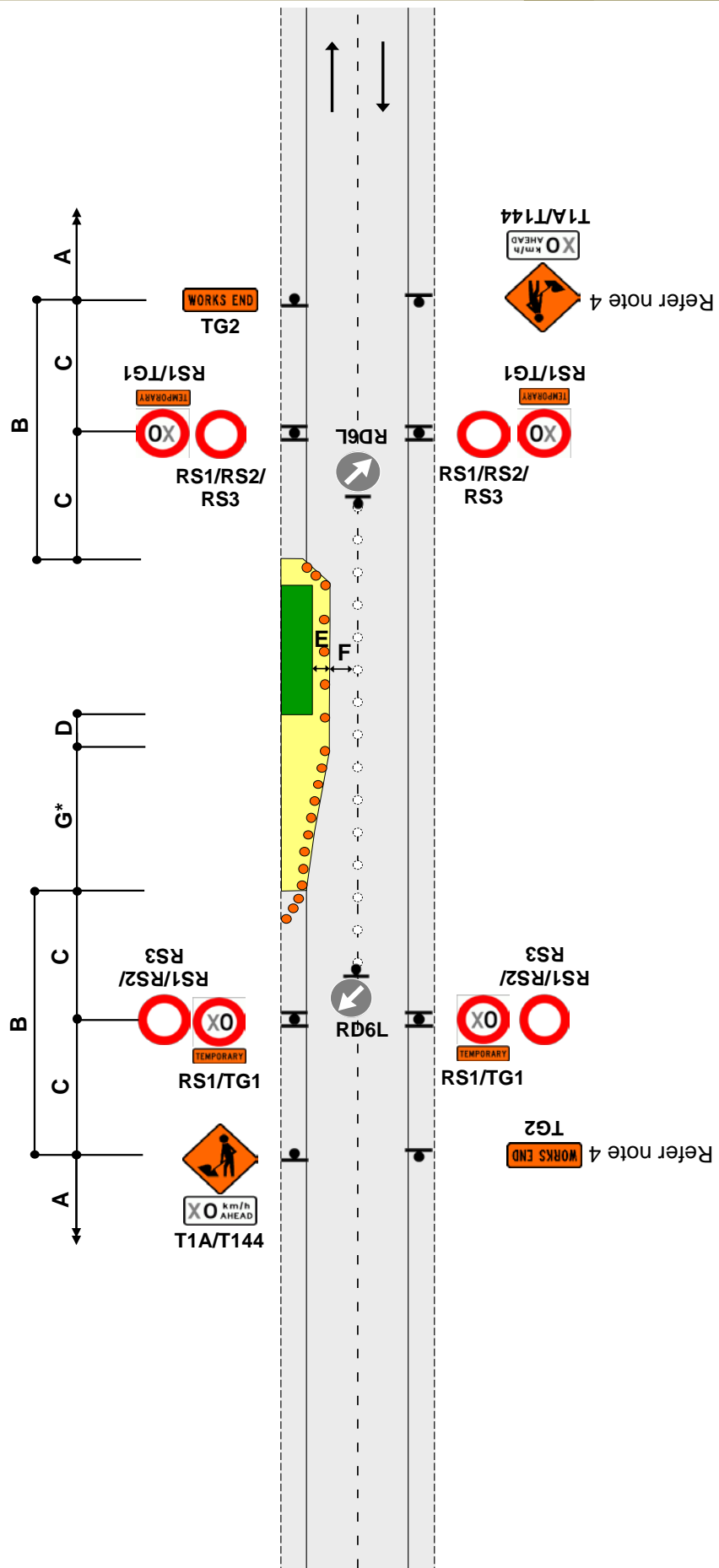

Notes

1. Use this diagram if signs will not be visible on left-hand side of road, or if it is safer to place signs on median and this will not interfere with turning traffic movements
2. Where a median exists which is more than 2m wide, the signs may be positioned on the median. Signs must be placed back-to-back unless on a solid median
3. Where there is a solid median, signs are not required in the opposing direction
4. *Calculation of taper length for lateral shift of less than 3.5m is:

$$\frac{W \times G}{3.5}$$

W = Width of lateral shift
 G = Taper length in metres from the level 1 layout distance table
5. Use TSLs if required by TSL decision matrix
6. The T144 X0km/h AHEAD sign is optional

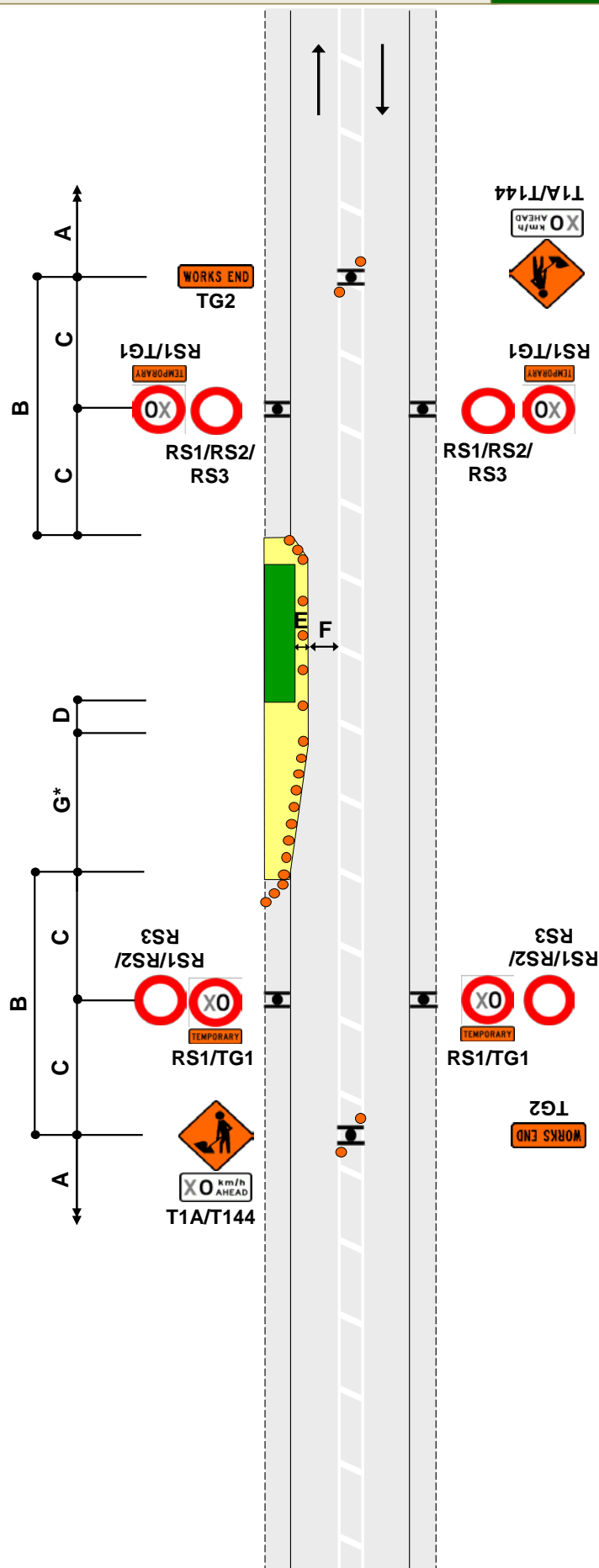

TWO-WAY TWO-LANE ROAD

Traffic crossing road centre

Two lane diversion

F2.13

Level 1

Notes

1. Cones are required on edge of the temporary lane opposite closure if road is not well defined
2. Return taper at end of closure may be shortened
3. *Calculation of taper length for lateral shift of less than 3.5m is:

$$\frac{W \times G}{3.5}$$

W = Width of lateral shift
 G = Taper length in metres from the level 1 layout distance table
4. To allow heavy vehicles to manoeuvre, cones in the channel must be offset by at least 10m where the direction changes. Refer C8.2.12
5. Use PN11 No Stopping signs, if necessary
6. Use TSLs if required by TSL decision matrix
7. The T144 X0km/h AHEAD sign is optional

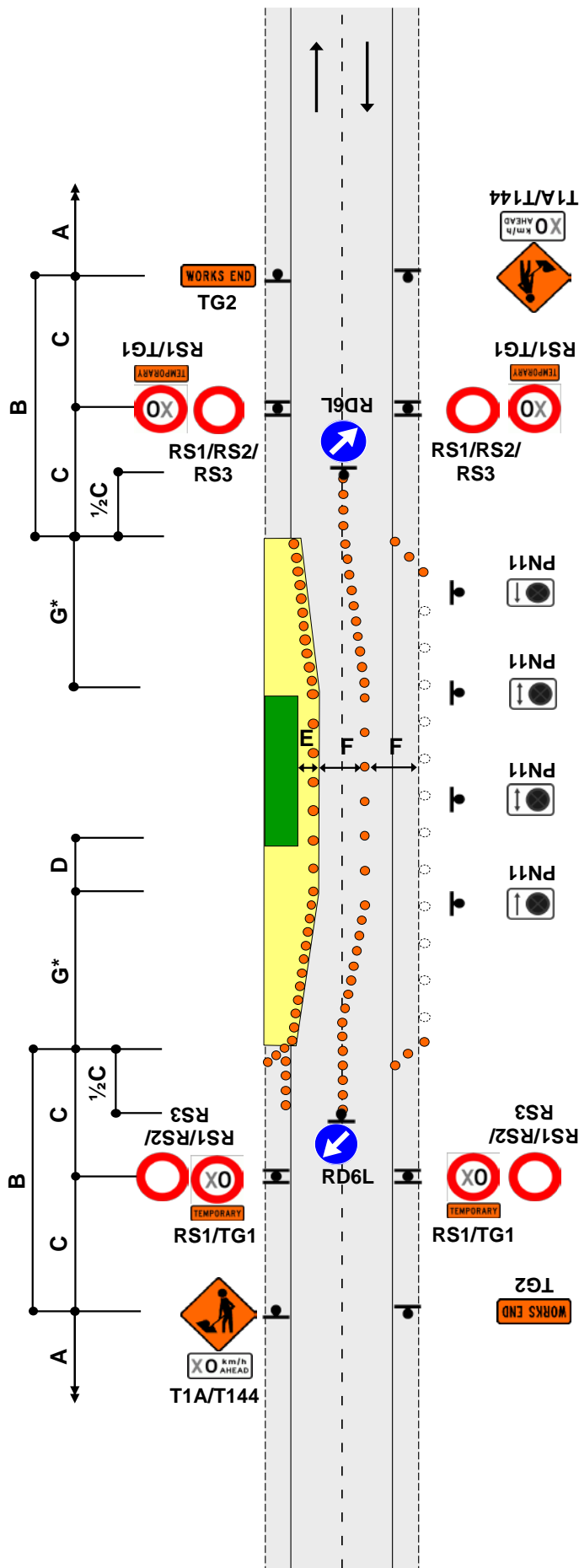

Notes

1. Extend or place extra advance warning signs towards on-coming traffic beyond any expected traffic queues
2. A 30m return taper at the end of the closure is mandatory
3. Cones are required on edge of the temporary lane opposite closure if road is not well defined
4. To allow heavy vehicles to manoeuvre, cones in the channel must be offset by at least 10m where the direction changes. Refer C8.2.12
5. Use PN11 no stopping signs, if necessary
6. MTC with RP4/RP41 STOP/GO or RP4/RP42 STOP/SLOW paddle on road shoulder located between 1st and 2nd cone in the cone threshold closest to the working space
7. Minimum 5 cones in cone threshold at:
 - 2.5m centres - less than 65km/h
 - 5m centres - more than 65km/h
8. Refer to C10.2.3 MTC essentials for further information
9. Delays cannot exceed the time approved by the RCA (normally 5 to 10 minutes)
10. The T144 30km/h AHEAD sign is optional

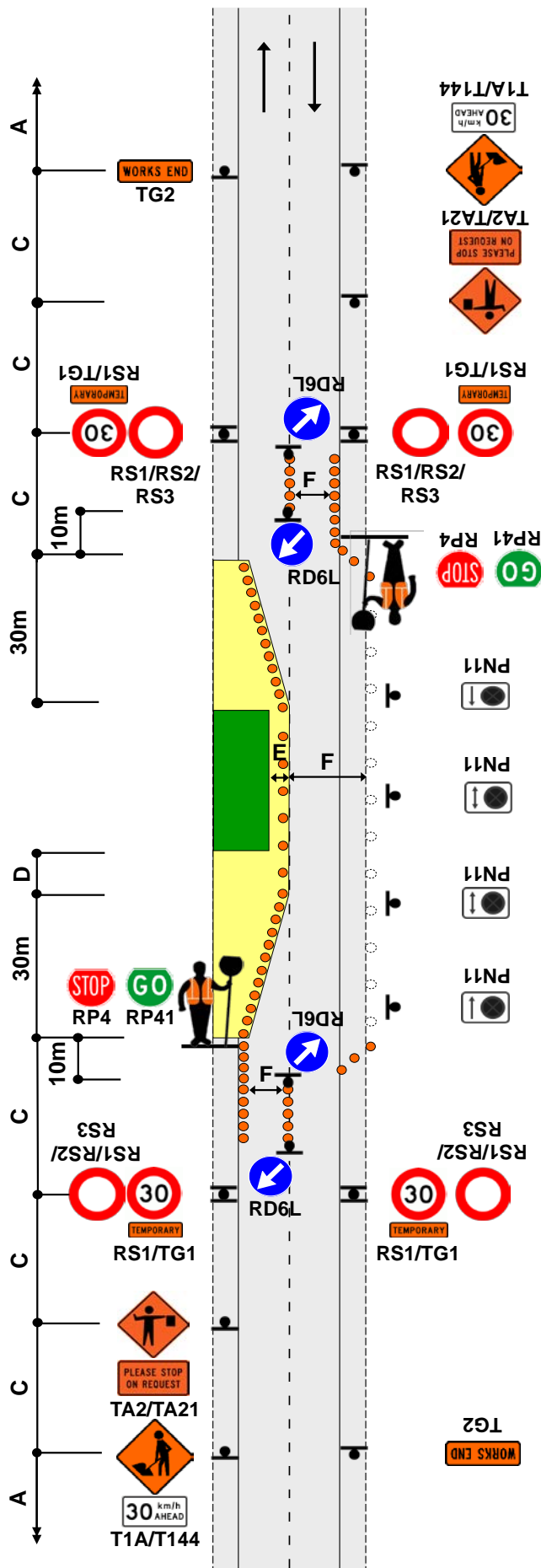

TWO-WAY TWO-LANE ROAD

All traffic stopped temporarily
Manual traffic control (STOP/GO or STOP/SLOW)

F2.15

Level 1

Notes

1. Closure period not to exceed the limit set or approved by the RCA
2. Extend advance warning signs towards on-coming traffic beyond any expected traffic queues
3. MTC with RP4/RP41 STOP/GO or RP4/RP42 STOP/SLOW paddle on road shoulder located between 1st and 2nd cone in the cone threshold closest to the working space
4. Minimum 5 cones in cone threshold at:
 - 2.5m centres - less than 65km/h
 - 5m centres - more than 65km/h
5. MTCs must show same message to oncoming traffic (eg STOP/STOP or GO/GO)
6. Refer to C10.2.3 MTC essentials for further information
7. When road users are passing the working space in alternating flow, all construction equipment must be stopped on same side of the road if there is no separation from the live lane
8. Where damage is likely to occur to passing traffic eg during sealing, traffic must be stopped in both directions
9. The T144 X0km/h AHEAD sign is optional

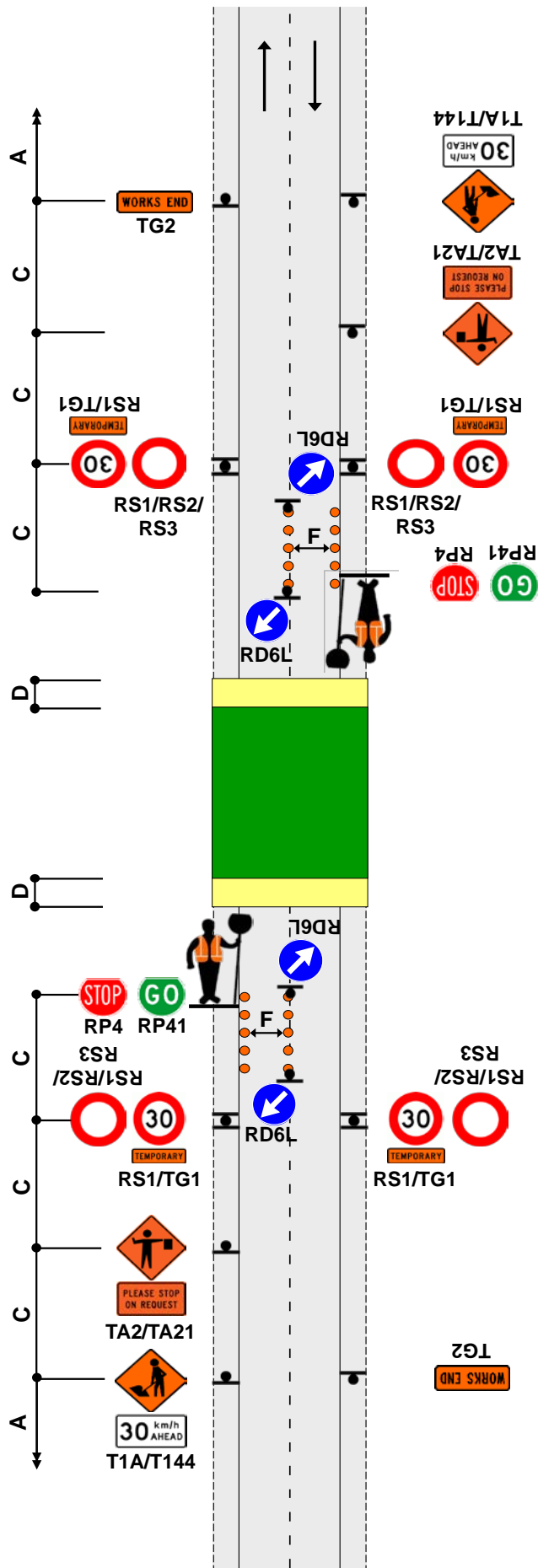

TWO-WAY TWO-LANE ROAD

Single-lane (traffic volume less than 1000vpd - 80vph)
Give way control

F2.16

Level 1

Notes

- The RP51/RP22 and RP52 controls must be placed in the following priority order:
 - downhill traffic must give way to uphill traffic
 - traffic that has to cross into the opposing lane gives way, however where visibility for this vehicle is marginal the contractor may require the other vehicle with better visibility to give way
- Intervisibility is required as indicated on diagram. This means that a vehicle at one sign is able to see whether the way ahead is clear
- A 30m return taper at the end of the closure is mandatory
- Use PN11 No Stopping signs, if necessary
- Cones are required on edge of the temporary lane opposite closure if road is not well defined
- The T144 X0km/h AHEAD sign is optional

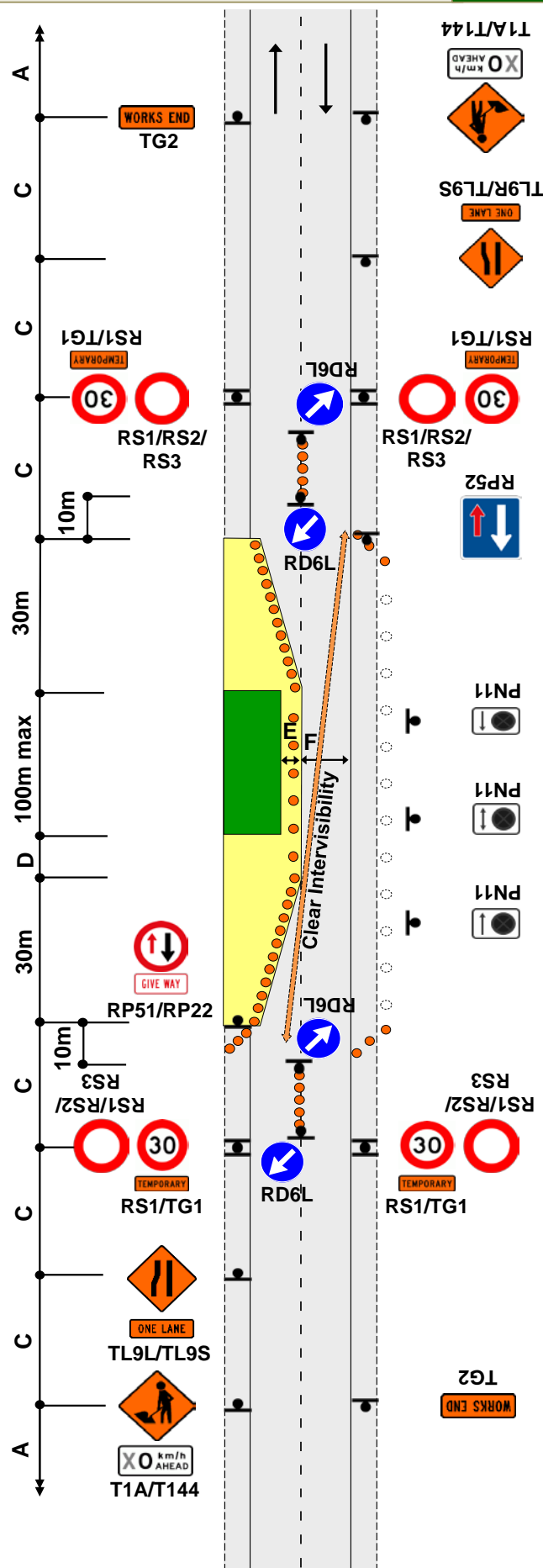

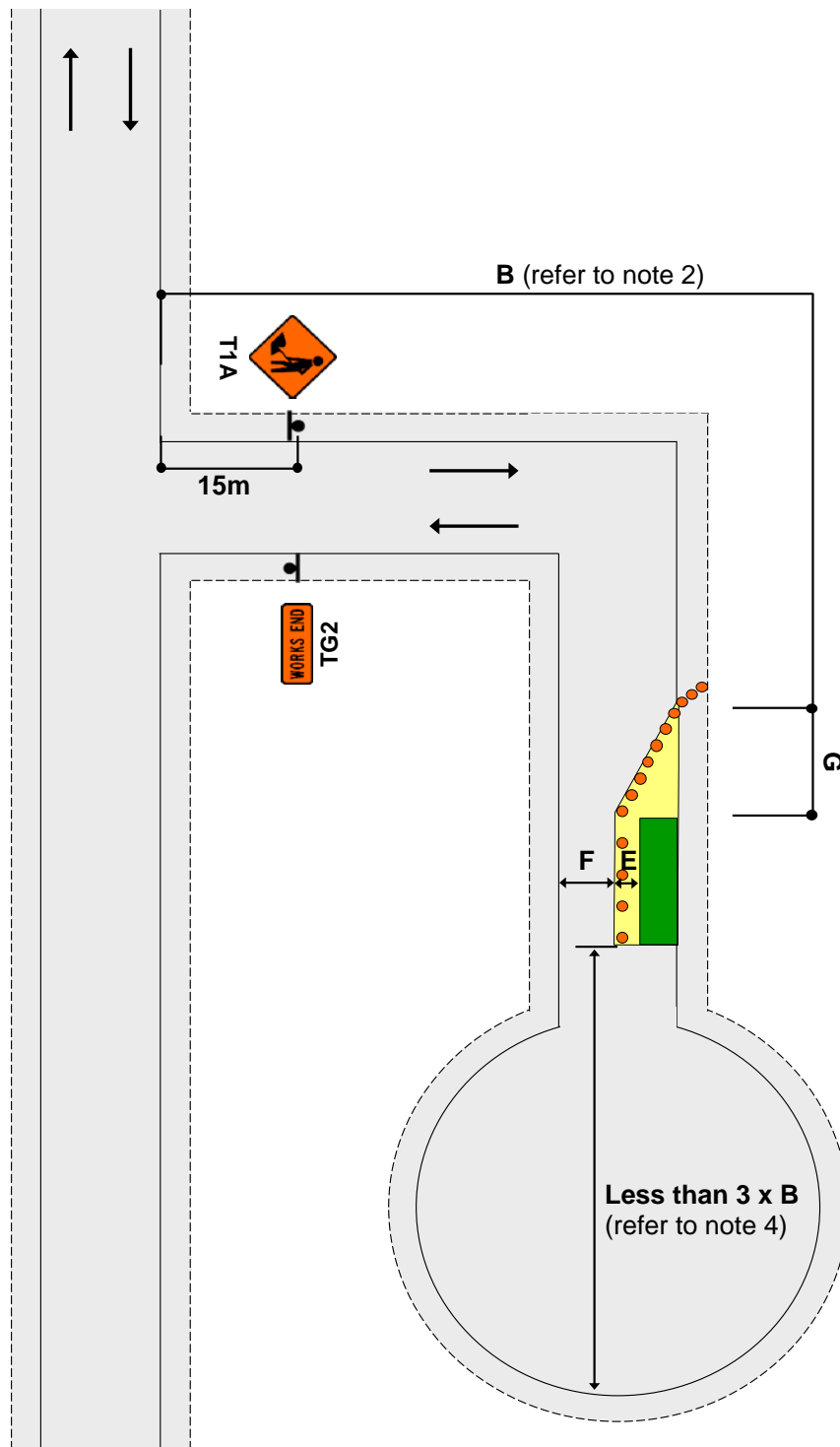

Notes

1. T1A sign to be placed at least 15m from the intersection
2. Where less than B, T1A/T135 and TG2 signs required on main road
3. Working space to be less than 100m
4. Signage is not required past the worksite where there is less than 3 x B from the end of the working space to the end of the road

Notes

1. Provide details of make and model of portable traffic signals in the TMP
2. Install temporary limit lines (must be able to be removed upon completion) or use RP61/RP62 signs



3. Approved temporary speed humps may also be used. Consider use of MTC while speed humps are installed
4. A 30m return taper at the end of the closure is mandatory
5. Cones are required on edge of the temporary lane opposite closure if road is not well defined
6. Extend or place extra advance warning signs towards on-coming traffic beyond any expected traffic queues
7. Use PN11 No Stopping signs, if necessary
8. Minimum 5 cones in cone threshold at:
 - 2.5m centres - less than 65km/h
 - 5m centres - more than 65km/h
9. The T144 30km/h AHEAD sign is optional

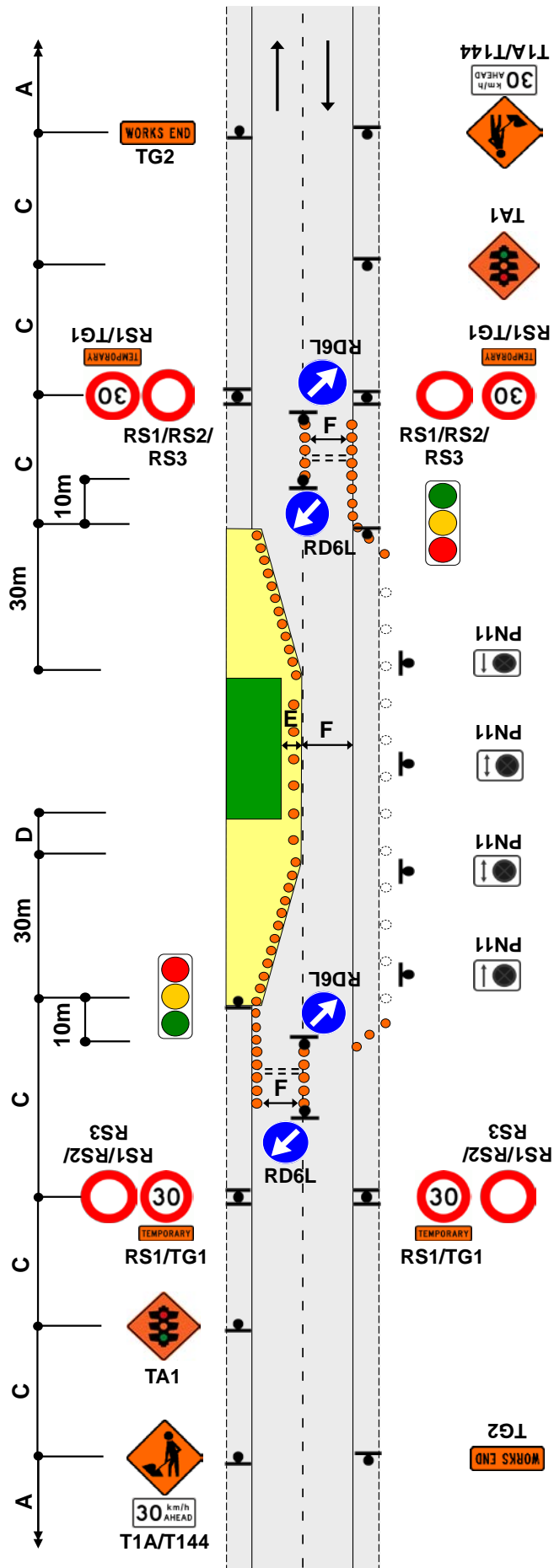

Notes

1. Cones are required on edge of the temporary lane opposite closure if road is not well defined
2. *Calculation of taper length for lateral shift of less than 3.5m is:
$$\frac{W \times G}{3.5}$$

W = Width of lateral shift
G = Taper length in metres from the level 1 layout distance table
3. Use PN11 no stopping signs, if necessary
4. Use TSLs if required by TSL decision matrix
5. The T144 X0km/h AHEAD sign is optional

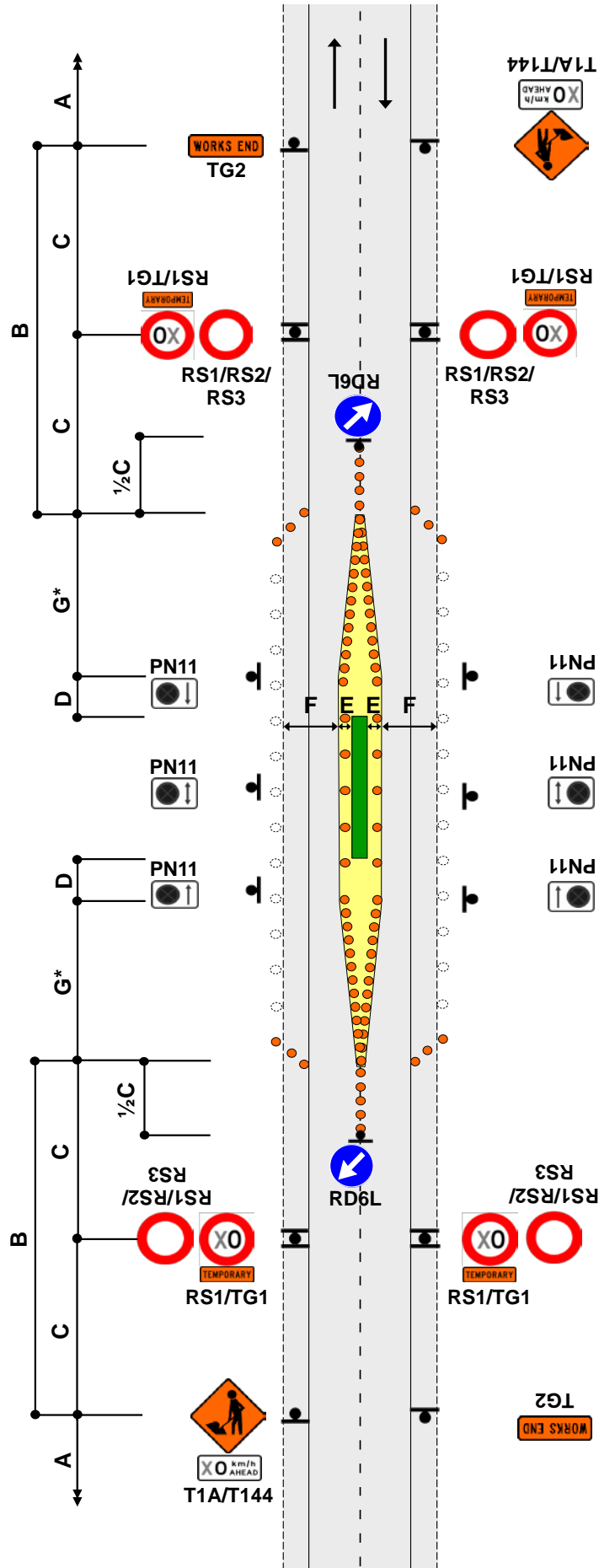

TWO-WAY TWO-LANE ROAD
In centre of road with median, signs on median

J2.18a
Level 1

Notes

1. Use this diagram if signs will not be visible from left-hand side of road, or if it is safer to place signs on median and this will not interfere with turning traffic movements
2. Where a median exists which is more than 1.5m wide, the signs may be positioned on the median. Signs must be placed back-to-back unless on a solid median
3. Where there is a solid median, signs are not required in the opposing direction
4. Cones are required on edge of the temporary lane opposite closure if road is not well defined
5. *Calculation of taper length for lateral shift of less than 3.5m is:

$$\frac{W \times G}{3.5}$$

W = Width of lane
 G = Taper length in metres from the level 1 layout distance table
6. Use PN11 No Stopping signs, if necessary
7. Use TSLs if required by TSL decision matrix
8. The T144 X0km/h AHEAD sign is optional

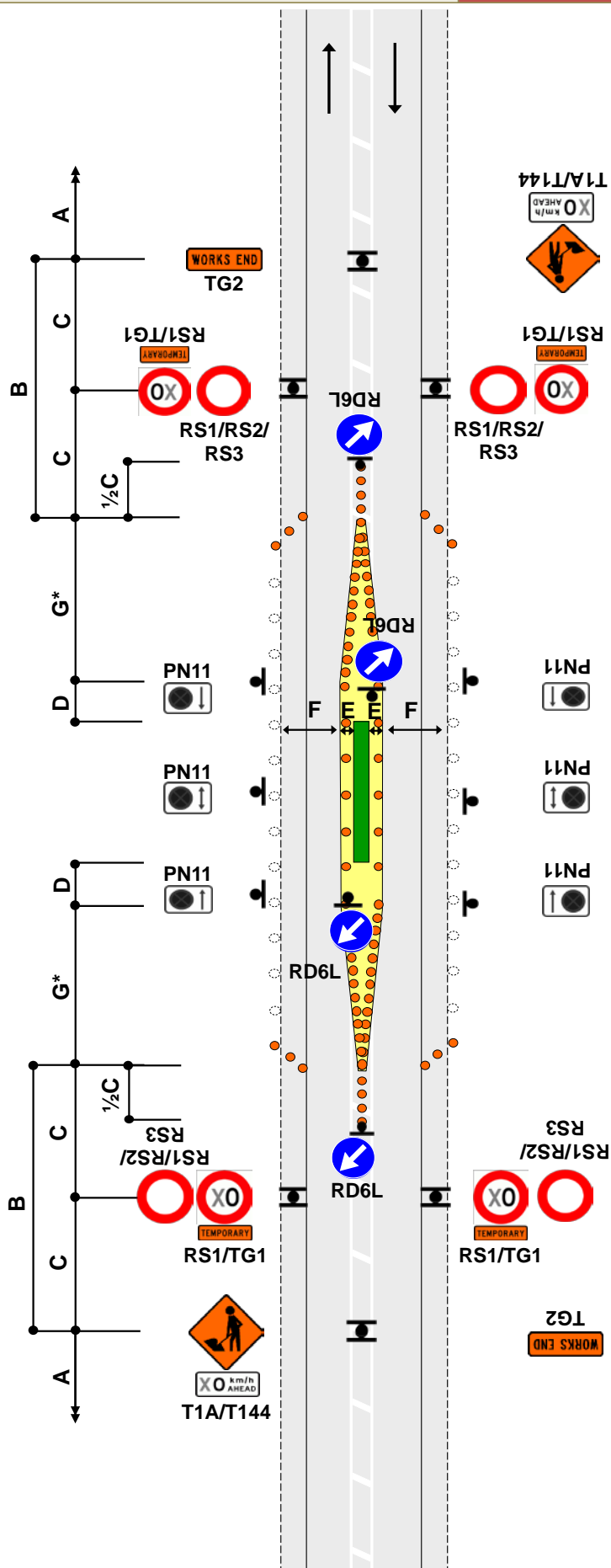

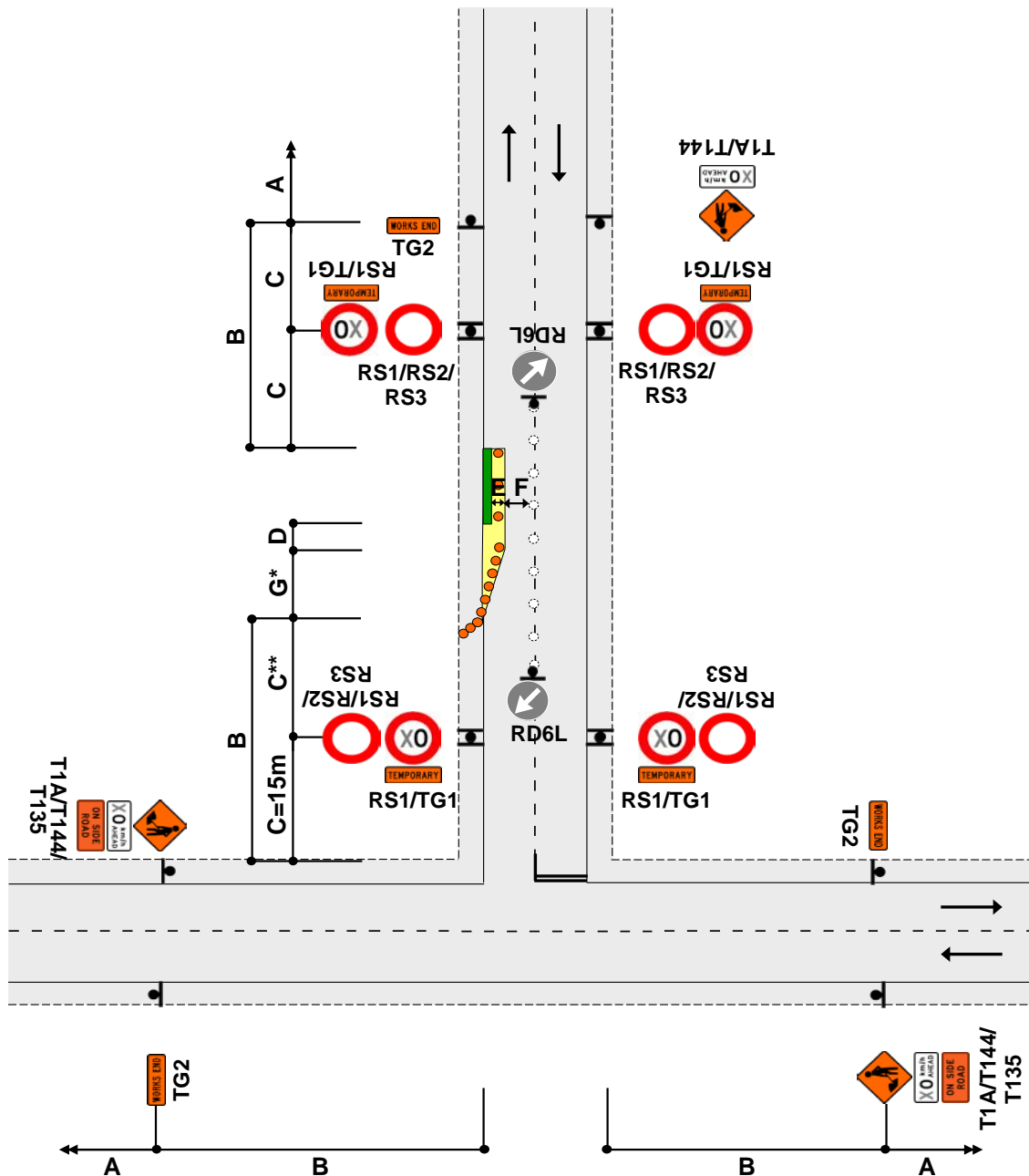

Notes

1. Sign spacing of TSL at the intersection can be reduced as per the table shown below
2. Where minimum dimensions cannot be achieved TMD F2.20 is to be used
3. *Calculation of taper length for lateral shift of less than 3.5m is:

$$\frac{W \times G}{3.5}$$
 W = Width of lateral shift
 G = Taper length in metres from the level 1 layout distance table
4. If traffic likely to cross the centreline, place cones on the centreline with RD6L signs at each end
5. Use TSLs as required by TSL decision matrix
6. The T144 30km/h AHEAD sign is optional

Speed (PSL)	Intersection to TSL	TSL to taper	Total
<50km/h	15m	15m	30m
60km/h	15m	25m	40m
>70km/h	15m	40m	55m

TWO-WAY TWO-LANE ROAD - Intersection or roundabout
 Major obstruction close to intersection
 Allows shorter sign spacings and MTC operation

J2.19a
 Level 1

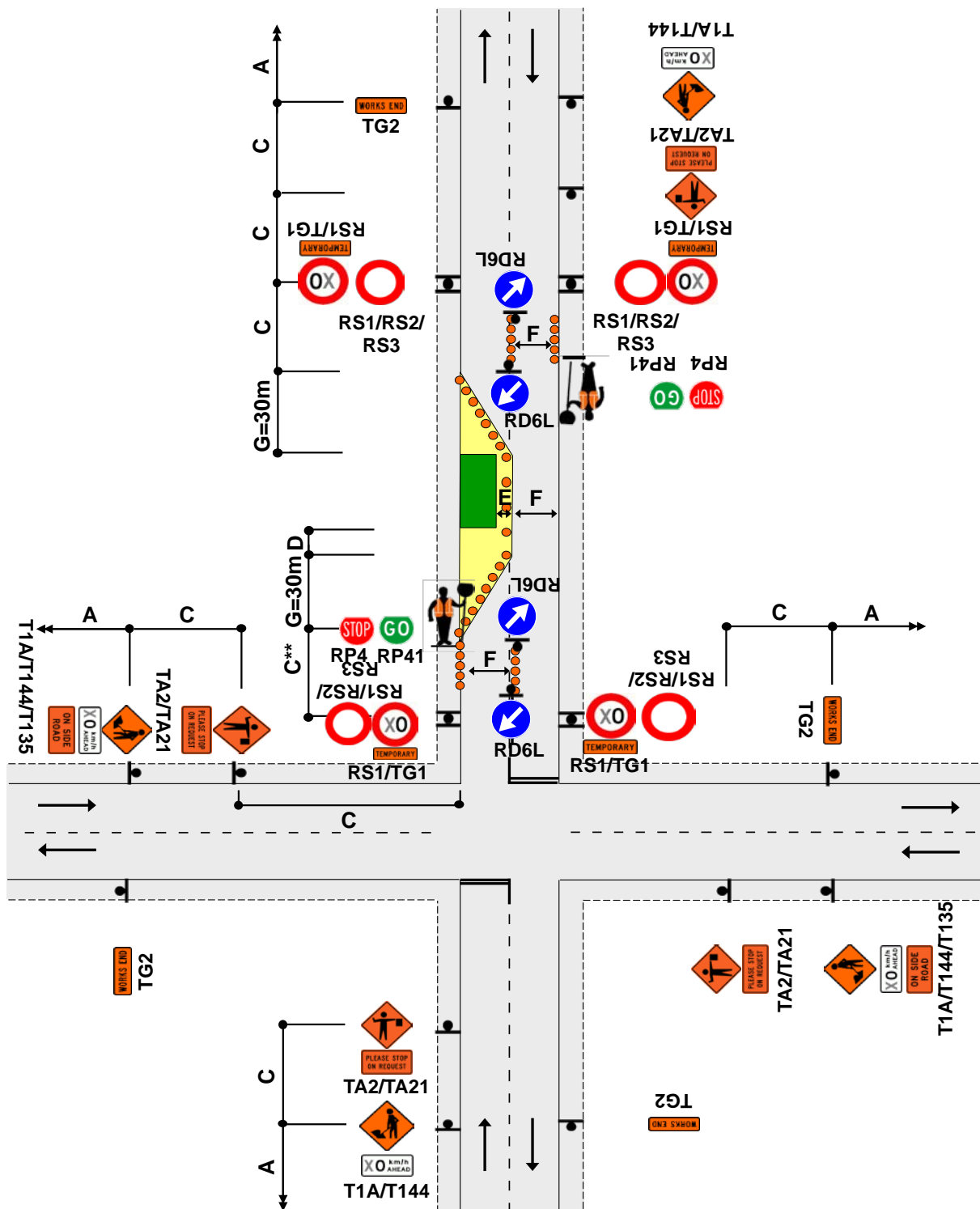

Notes

1. Sign spacing of TSL at the intersection can be reduced as per the table shown
2. This diagram may be used at a T intersection by removing any one of the roads
3. MTC at intersection to be in charge of MTC operation
4. Use TSLs as required by TSL decision matrix
5. The T144 30km/h AHEAD sign is optional

C**	DISTANCE		
	Speed (PSL)	Intersection to TSL	TSL to taper
<50km/h	15m	15m	30m
60km/h	15m	25m	40m
>70km/h	15m	40m	55m

STATIC OPERATIONS

TWO-WAY TWO-LANE ROAD - Intersection or roundabout
 Road works on side road after intersection - TSL on main road
 Traffic not crossing road centre

F2.20

Level 1

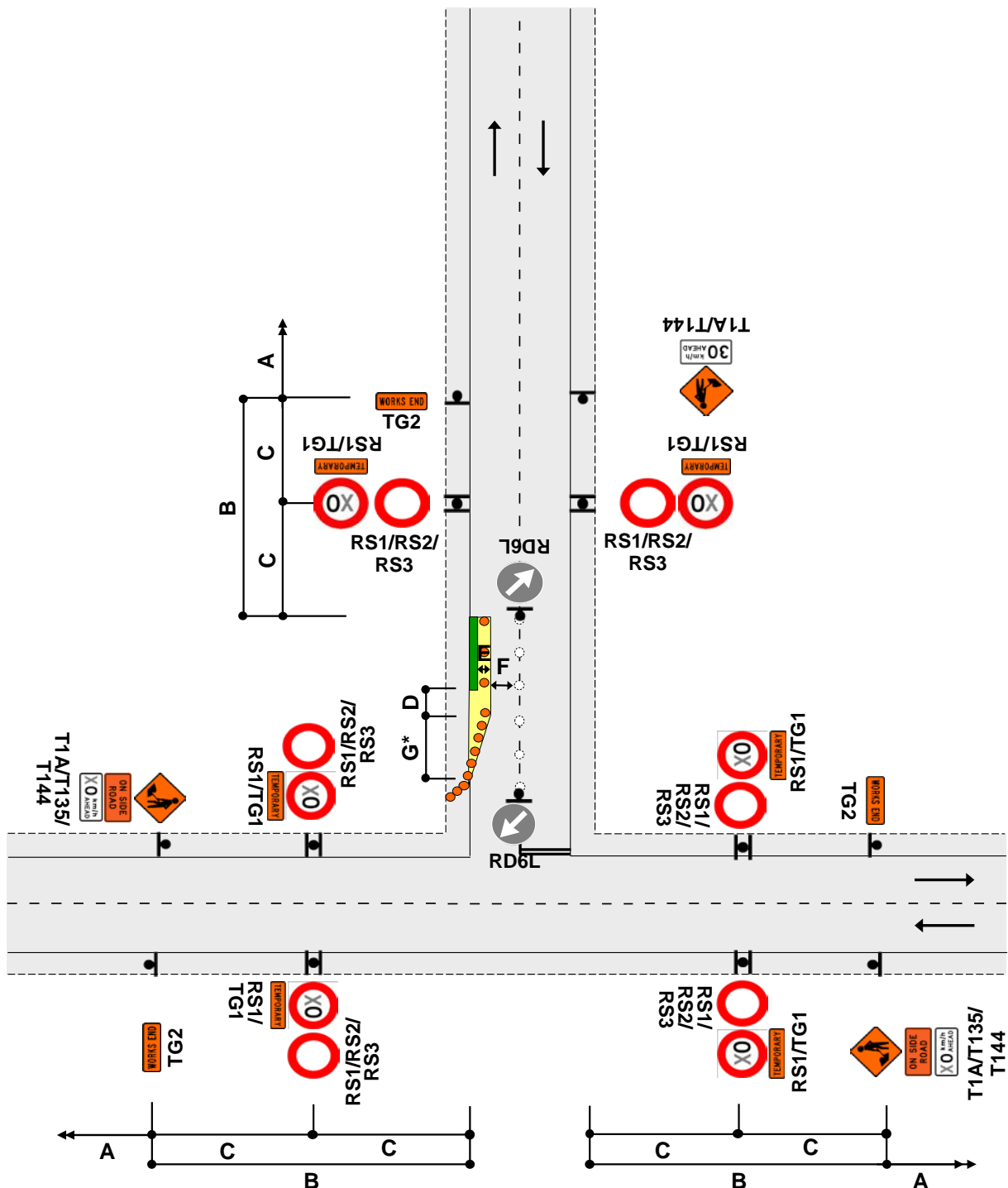

Notes

- * Calculation of taper length for lateral shift of less than 3.5m is:

$$\frac{W \times G}{3.5}$$

W = Width of lateral shift
 G = Taper length in metres from the level 1 layout distance table
- If traffic likely to cross the centreline, place cones on the centreline with RD6L signs at each end
- Use TSLs as required by TSL decision matrix
- The T144 X0km/h AHEAD sign is optional

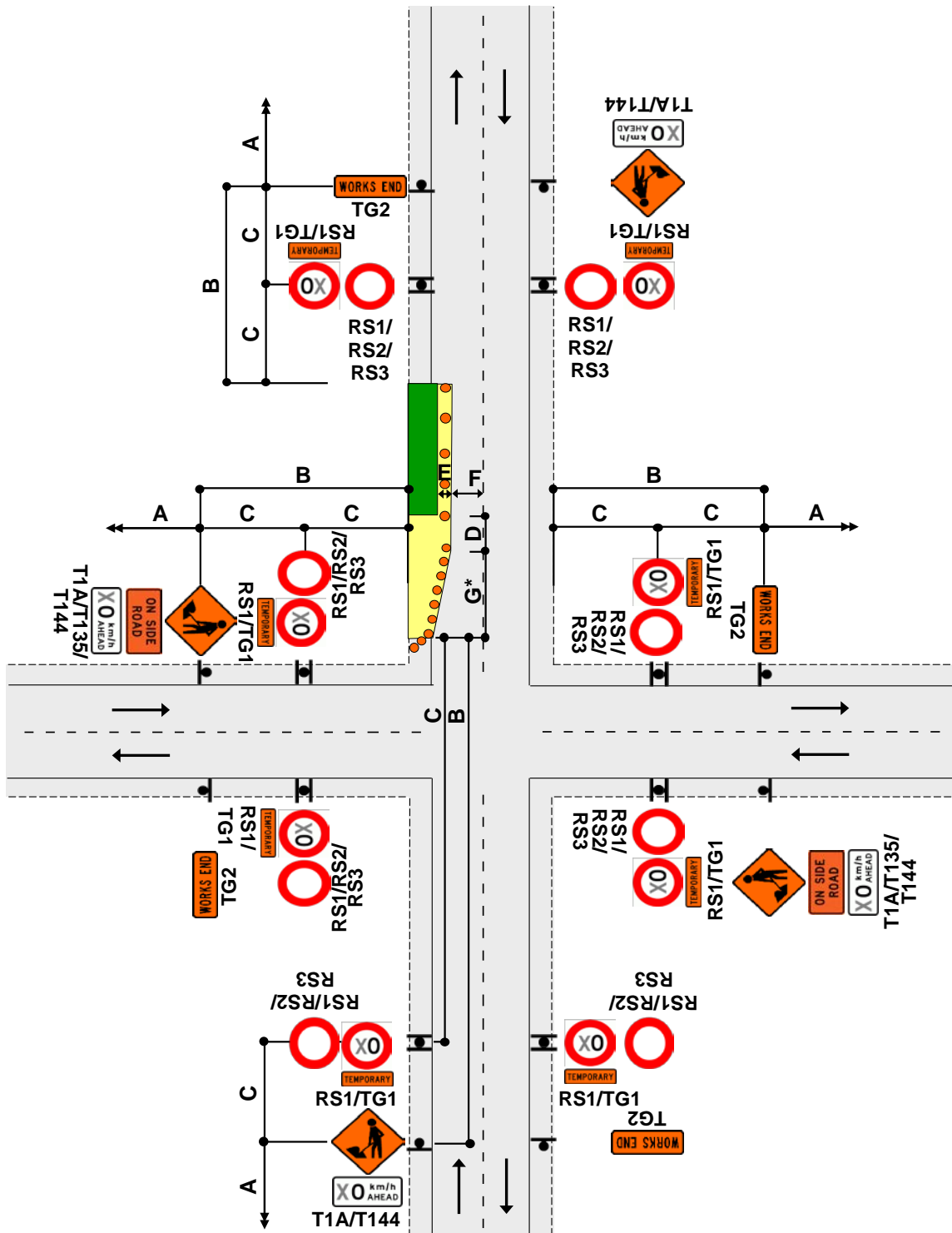

Notes

1. This diagram may be used at a T intersection by removing any one of the roads
2. Taper length may be reduced by adding a RD6R sign
3. *Calculation of taper length for lateral shift of less than 3.5m is:

$$\frac{W \times G}{3.5}$$

W = Width of Shoulder G = Taper length in metres from the level 1 layout distance table

4. Use TSLs if required by TSL decision matrix
5. The T144 X0km/h AHEAD sign is optional

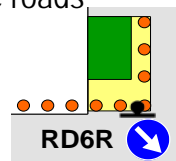

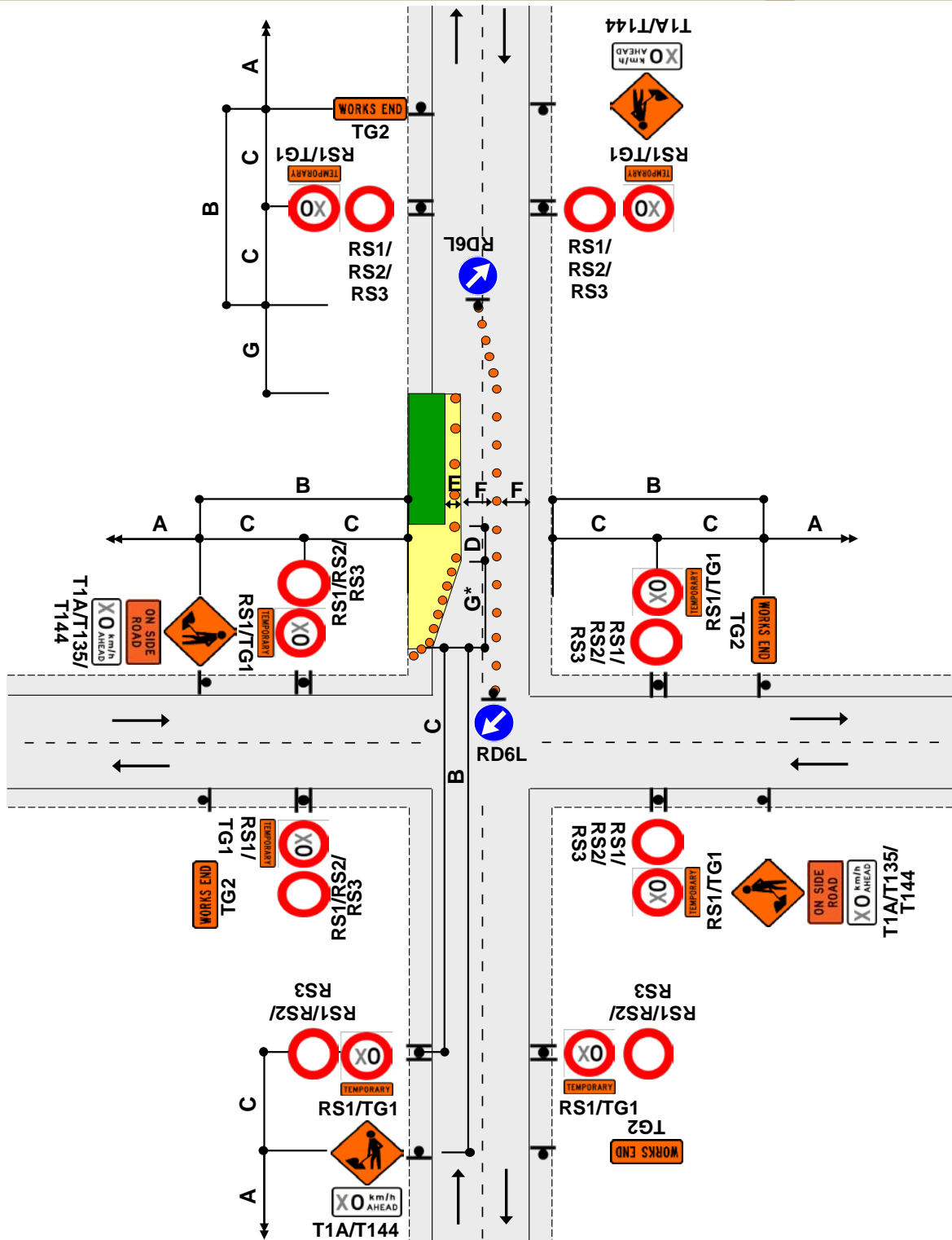

Notes

1. This diagram may be used at a T intersection by removing any one of the roads
2. Taper length may be reduced by adding a RD6R sign
3. *Calculation of taper length for lateral shift of less than 3.5m is:

$$\frac{W \times G}{3.5}$$

W = Width of Shoulder G = Taper length in metres from the level 1 layout distance table

4. Use TSLs if required by TSL decision matrix
5. The T144 X0km/h AHEAD sign is optional

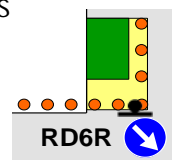

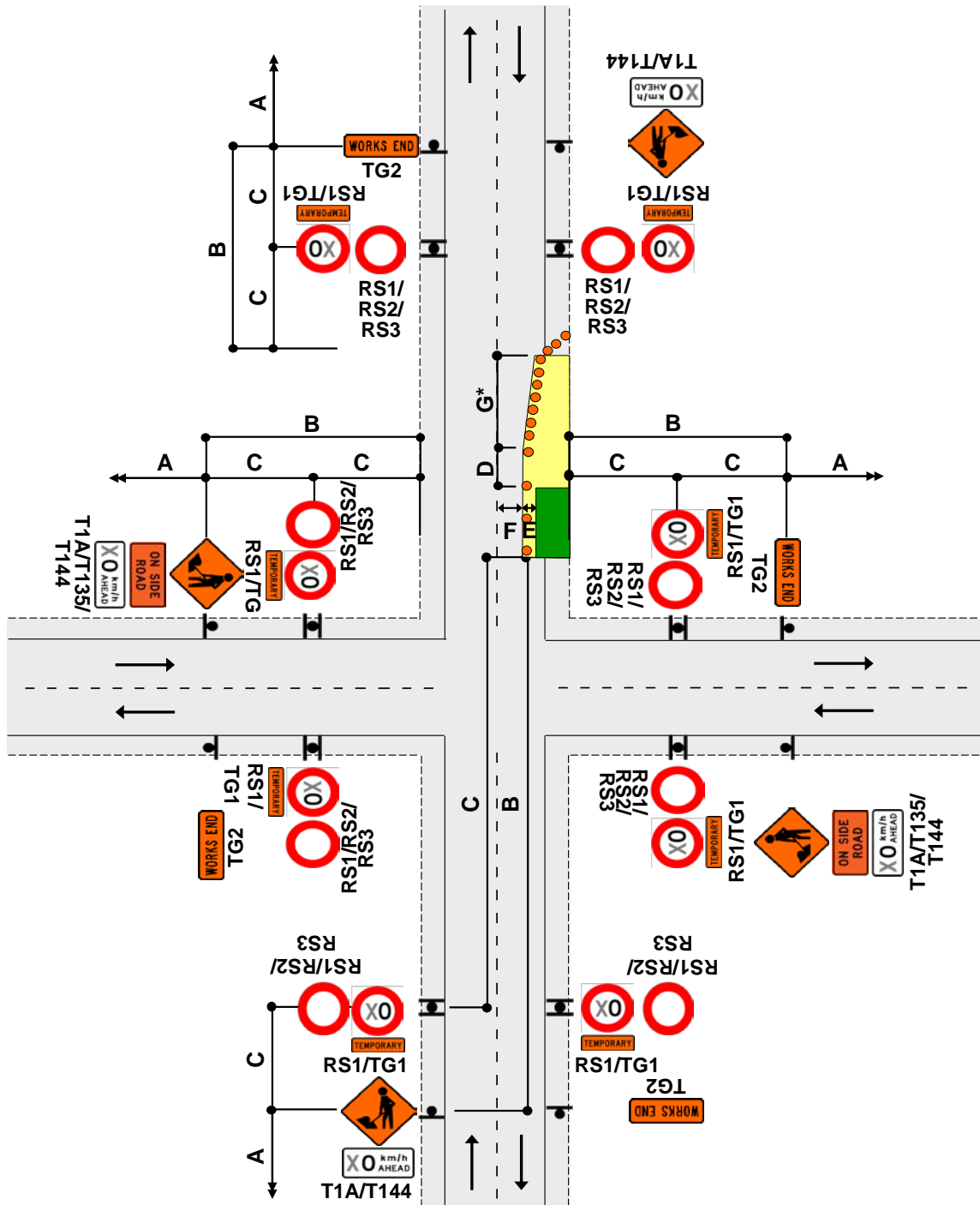

Notes

1. This diagram may be used at a T intersection by removing any one of the roads
2. Taper length may be reduced by adding a RD6R sign
3. *Calculation of taper length for lateral shift of less than 3.5m is:

$$\frac{W \times G}{3.5}$$

W = Width of Shoulder G = Taper length in metres from the level 1 layout distance table
4. Use TSLs if required by TSL decision matrix
5. The T144 X0km/h AHEAD sign is optional

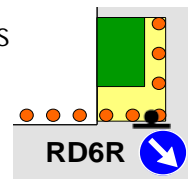

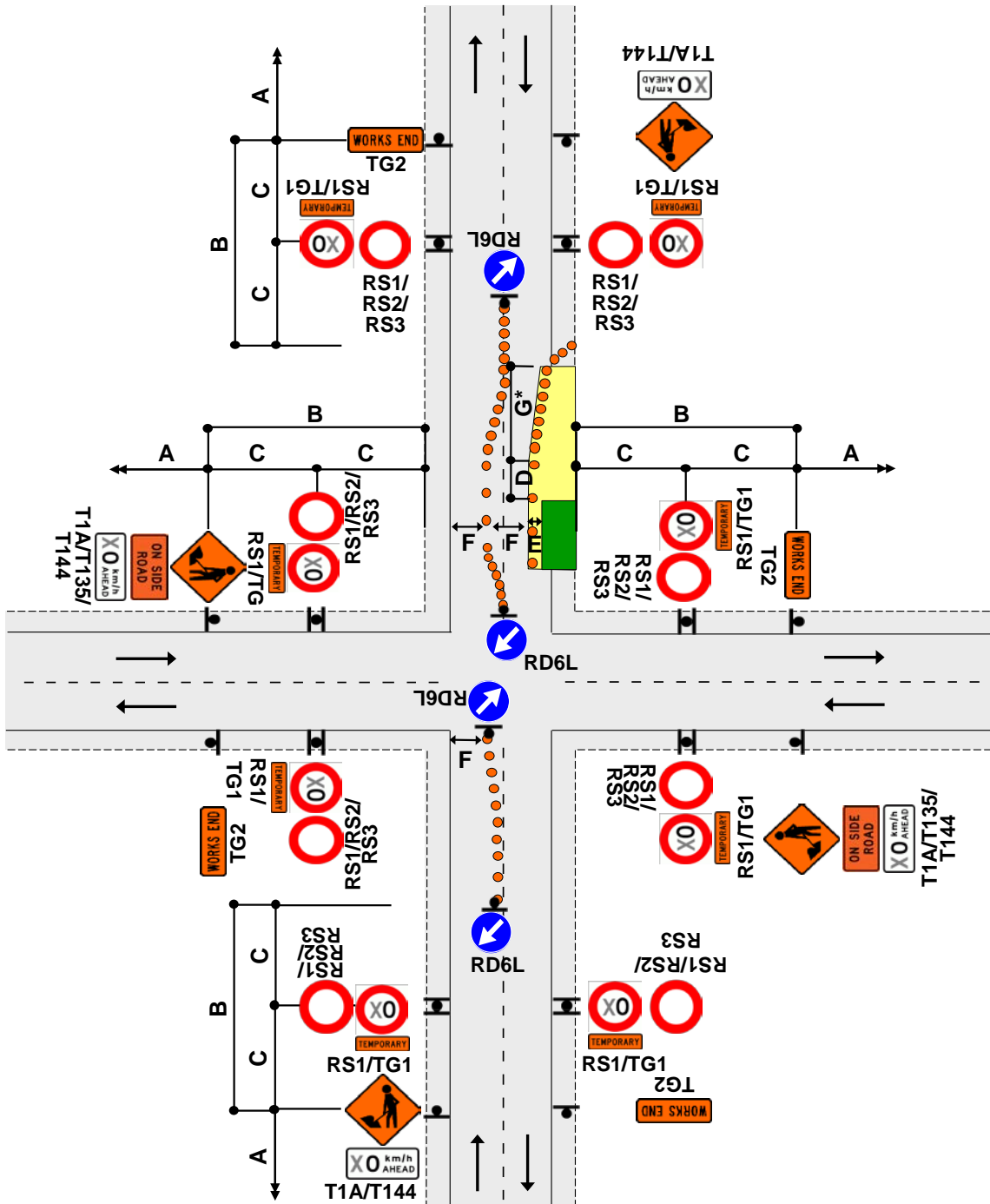

Notes

1. This diagram may be used at a T intersection by removing any one of the roads
2. *Calculation of taper length for lateral shift of less than 3.5m is:

$$\frac{W \times G}{3.5}$$

3.5

W = Width of lane G = Taper length in metres from the level 1 layout distance table

3. Install shifting taper to move road users into the new alignment
4. Use TSLs if required by TSL decision matrix
5. The T144 X0km/h AHEAD sign is optional

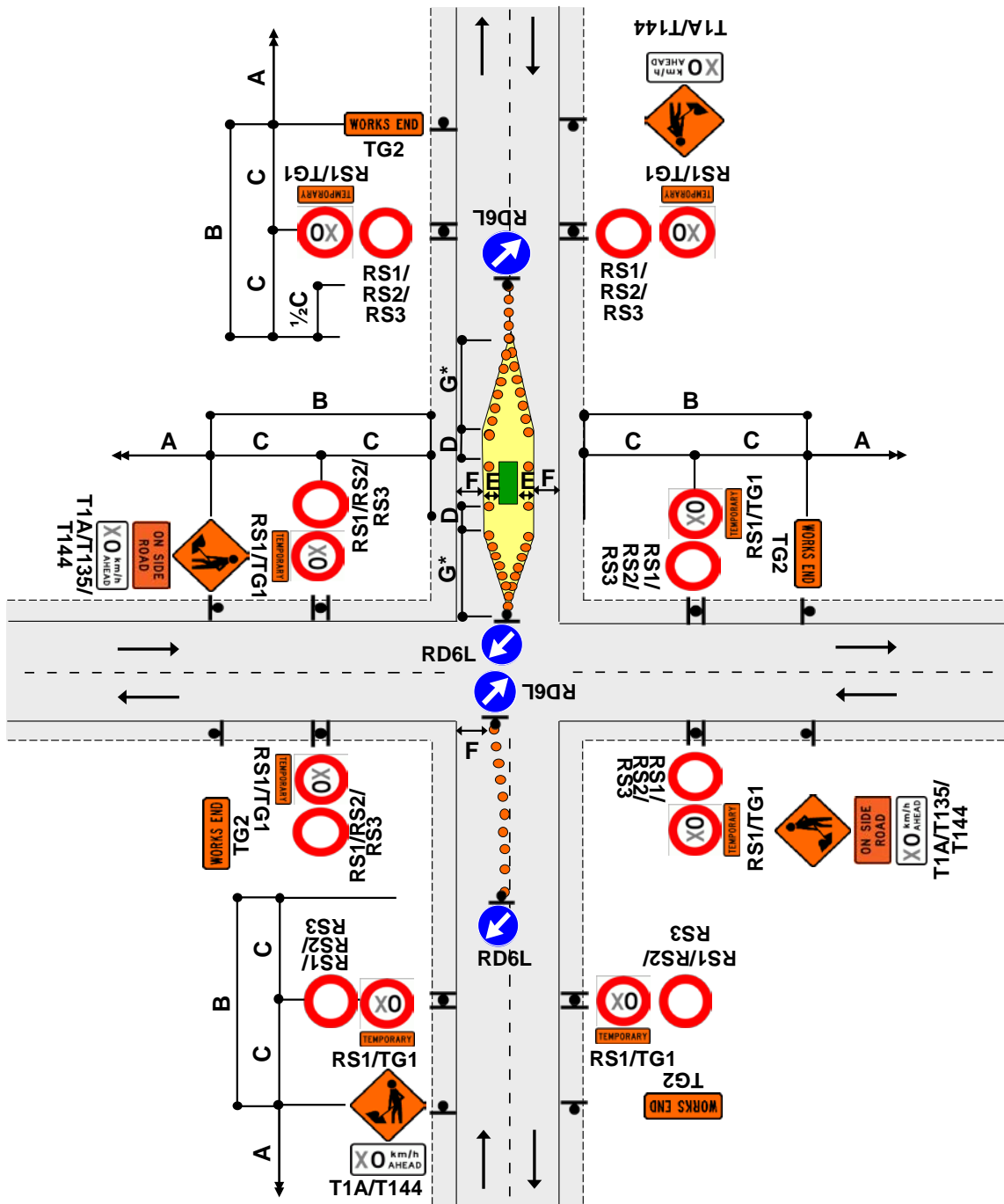

Notes

1. This diagram may be used at a T intersection by removing any one of the roads
2. *Calculation of taper length for lateral shift of less than 3.5m is:

$$\frac{W \times G}{3.5}$$

W = Width of lane G = Taper length in metres from the level 1 layout distance table

3. Install shifting taper to move road users into the new alignment
4. Use TSLs if required by TSL decision matrix
5. The T144 X0km/h AHEAD sign is optional

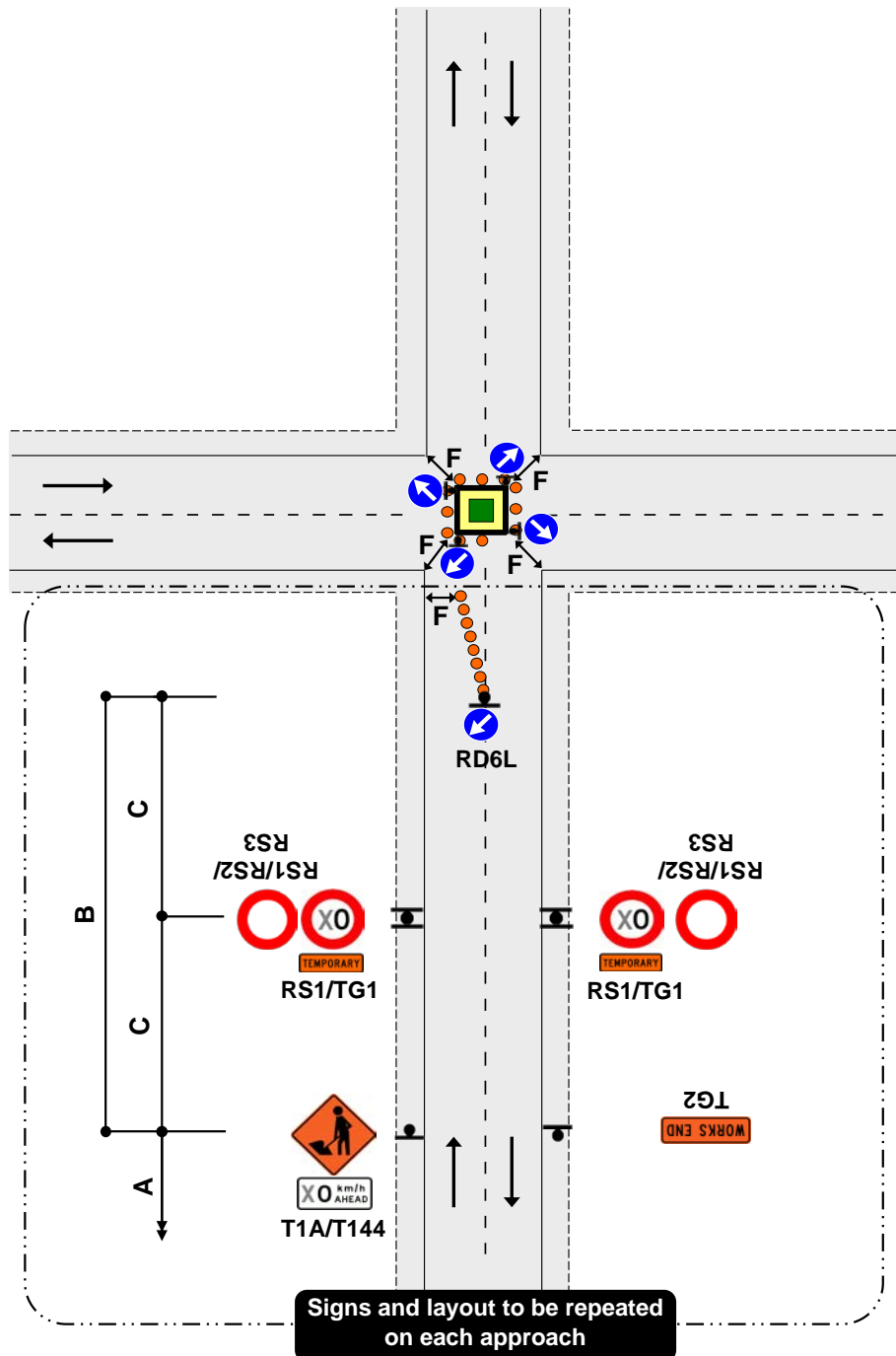

Notes

1. This diagram may be used at a T intersection by removing any one of the roads
2. Signs and layout shown in the box at the bottom of the diagram is to be repeated on each approach
3. RD6L signs are not required at an existing roundabout
4. Cone tapers are optional at existing roundabouts
5. Lane widths, F, may need to be increased to allow for turning movements of larger vehicles
6. Use TSLs if required by TSL decision matrix
7. The T144 X0km/h AHEAD sign is optional

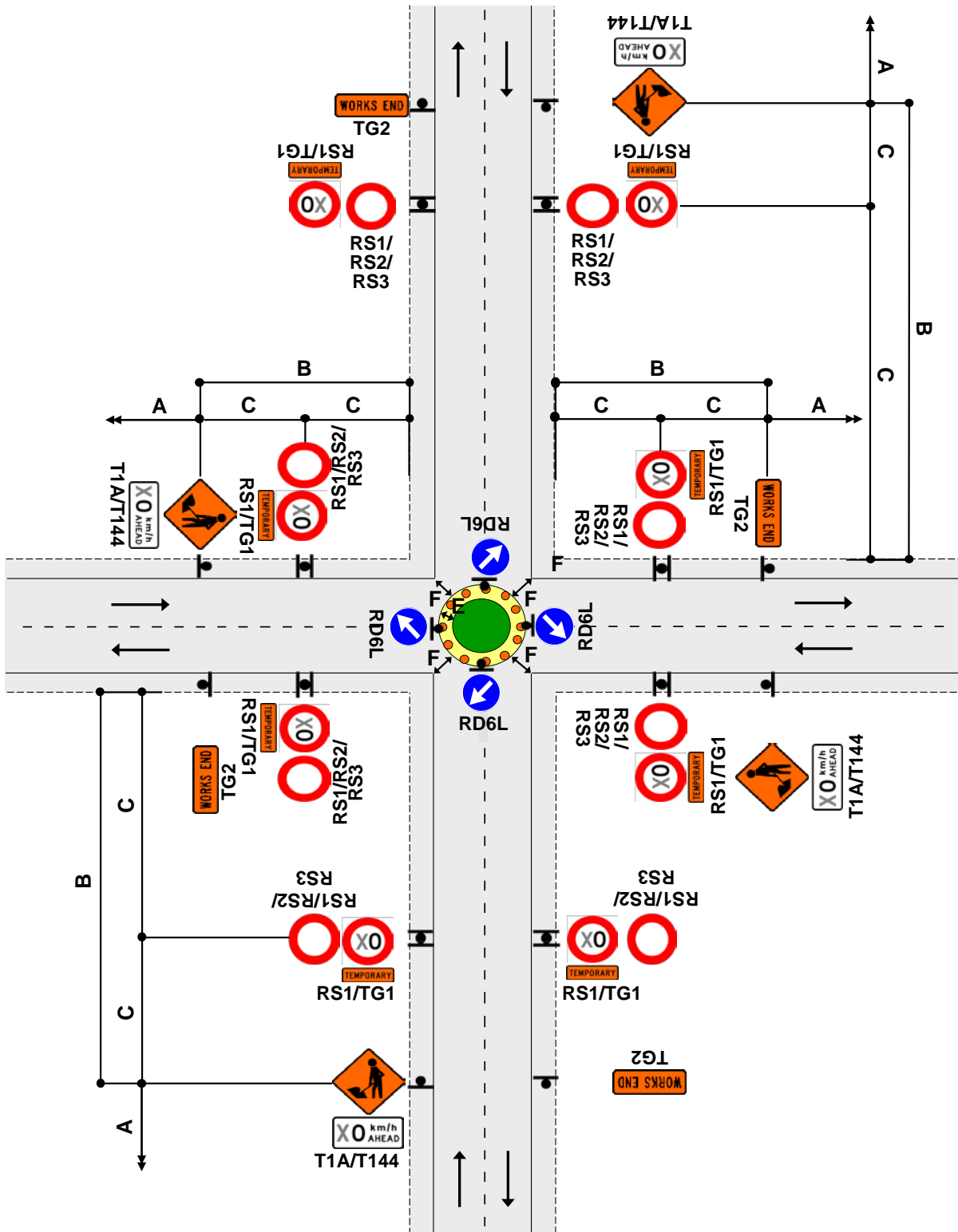

Notes

1. This diagram may be used at a T intersection by removing any one of the roads
2. RD6L signs not required at an existing roundabout which already has RD6Ls
3. Lane widths, F, may need to be increased to allow for turning movements of larger vehicles
4. Use TSLs if required by TSL decision matrix
5. The T144 X0km/h AHEAD sign is optional

TWO-WAY TWO-LANE ROAD - Intersection or roundabout
Closure at corner of an intersection
Manual traffic control (Stop/Go or Stop/Slow)

F2.22

Level 1

Notes

1. This diagram may be used at a T intersection by removing any one of the roads
2. Signs and layout shown in the box at the bottom of the diagram is to be repeated on each approach
3. A 30m return taper at the end of the closure is mandatory
4. Use PN11 no stopping signs, if necessary
5. MTC with RP4/RP41 STOP/GO or RP4/RP42 STOP/SLOW paddle on road shoulder located between 1st and 2nd cone in the cone threshold closest to the working space
6. Minimum 5 cones in cone threshold at:
 - 2.5m centres - less than 65km/h
 - 5m centres - more than 65km/h
7. Refer to C10.2.3 MTC essentials for further information
8. On roads with a permanent speed limit of 100km/h, cones are required from the TSL to the taper if the speed is reduced by more than 30km/h
9. The T144 30km/h AHEAD sign is optional

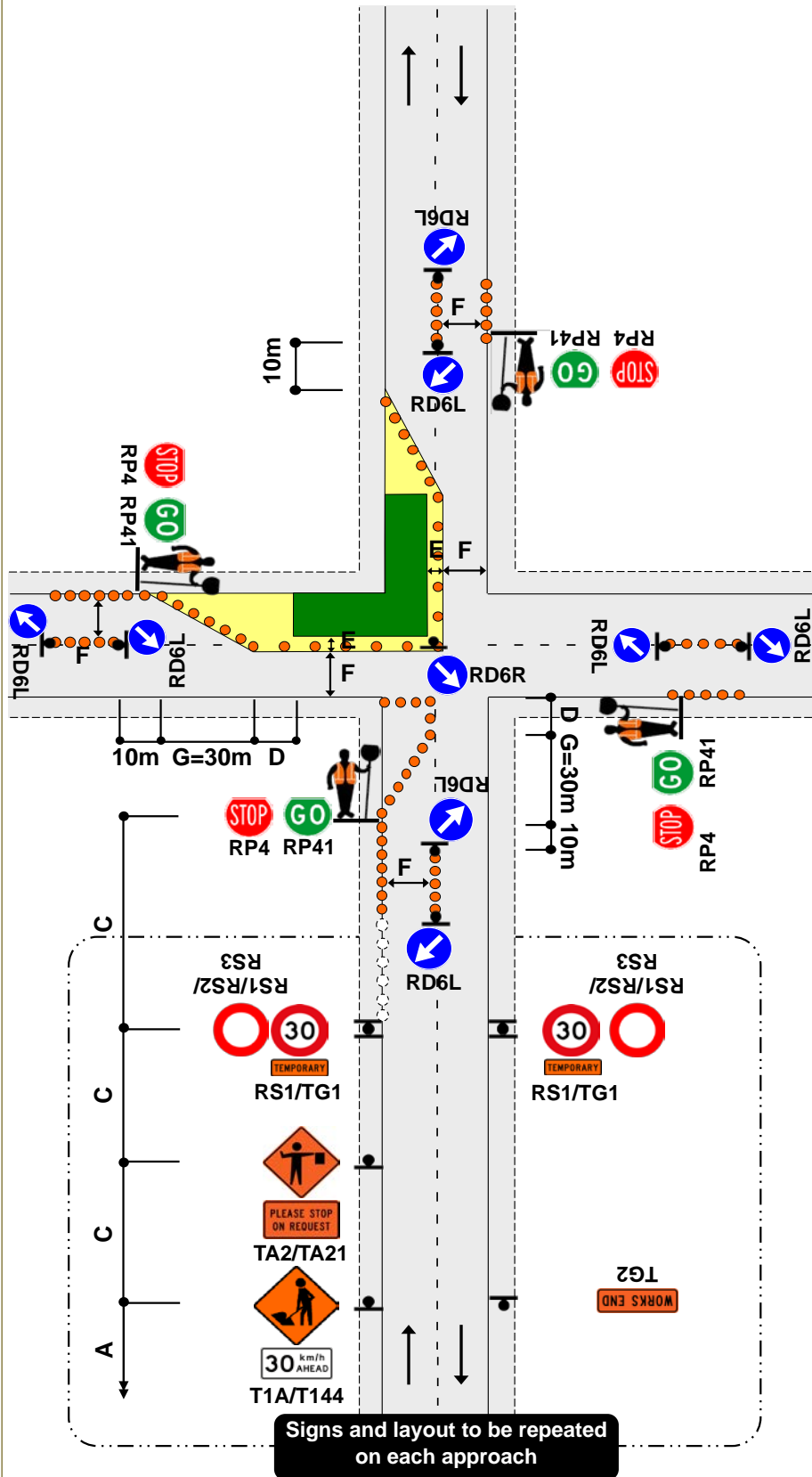

Notes

1. Use TSLs if required by TSL decision matrix
2. To allow heavy vehicles to manoeuvre, cones in the channel must be offset by at least 10m where the direction changes. Refer C8.2.12
3. On roads with a permanent speed limit of 100km/h, cones are required from the TSL to the taper if the speed is reduced by more than 30km/h
4. The T144 X0km/h AHEAD sign is optional

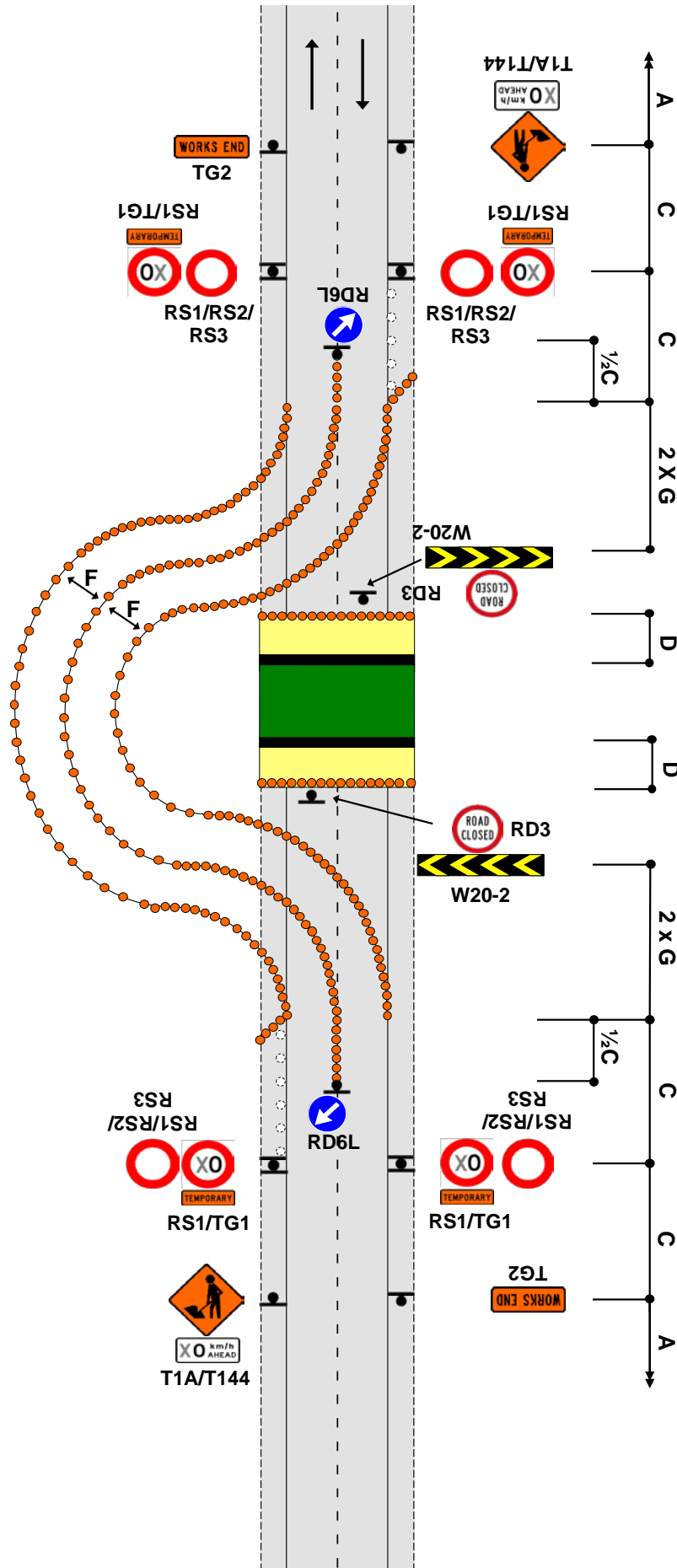

TWO-WAY TWO-LANE ROAD - Road closures and detours

Road closure - detour route

Example

F2.24

Level 1

Notes

1. Block access to road with barricade
2. If a longer term site, use chevron sight board to direct traffic

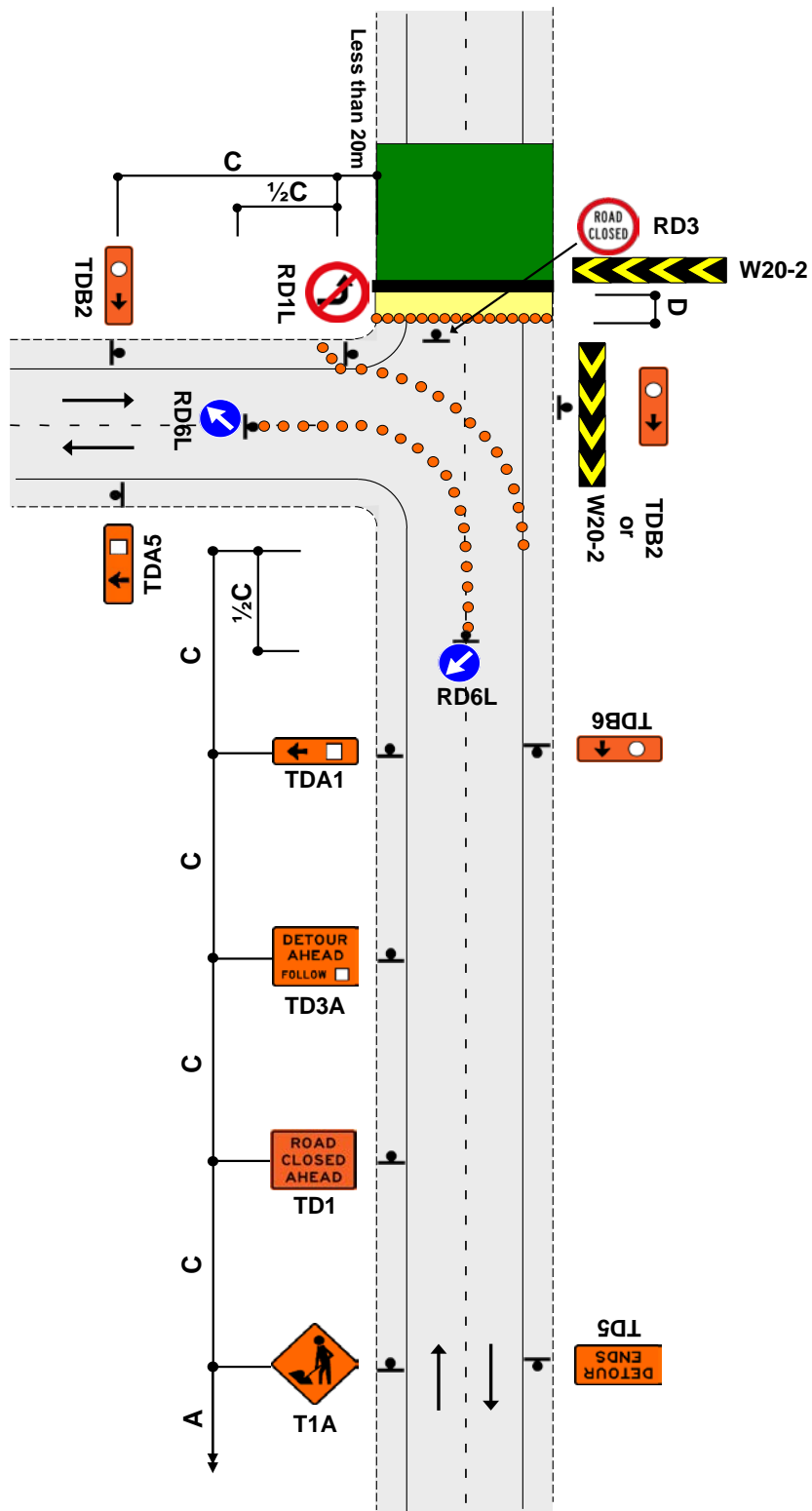

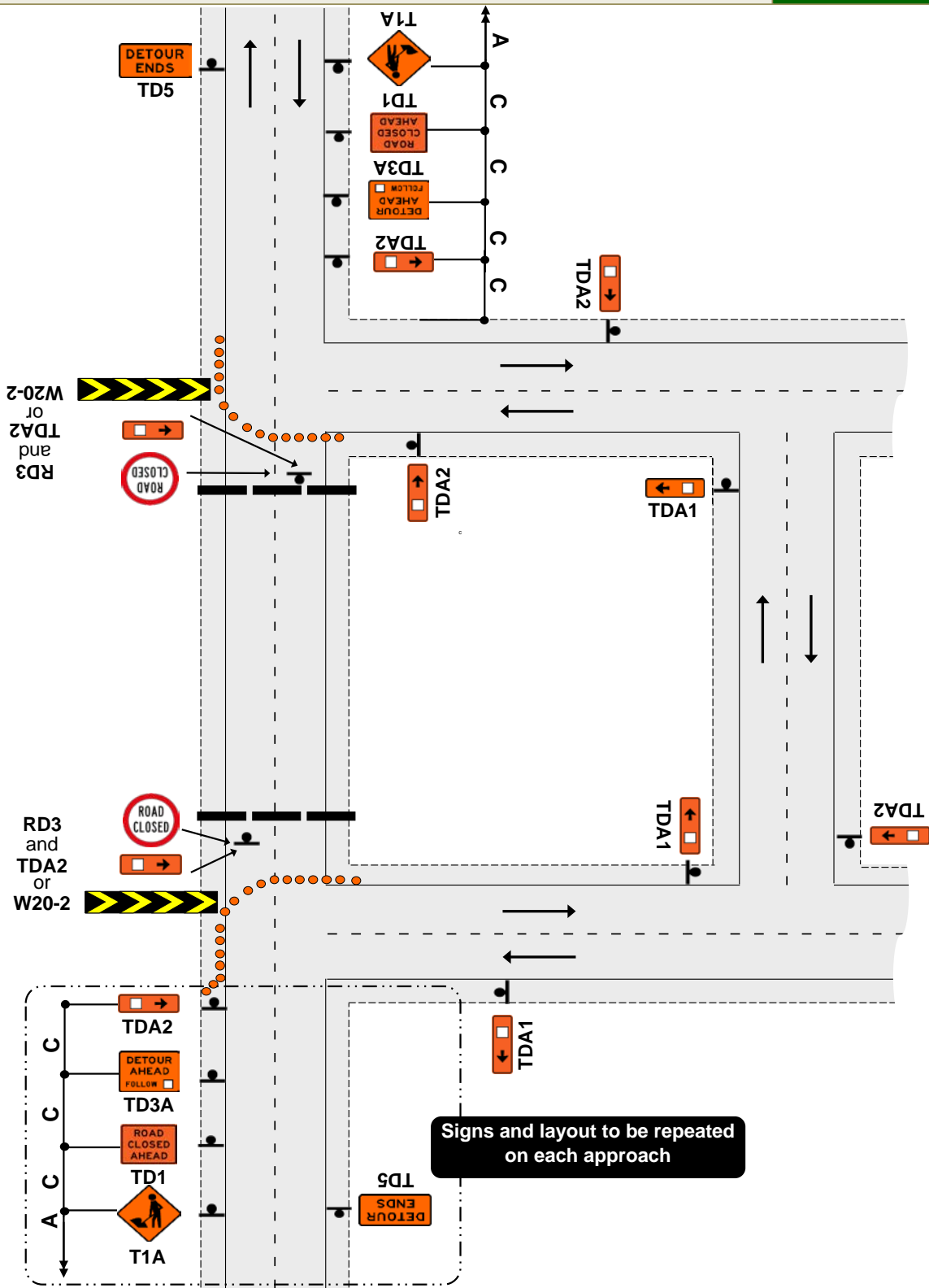

Notes

1. Signpost all intersections to return diverted traffic back to normal/intended route:
 - Use appropriate sign to indicate detour ahead (eg TD3A)
 - Use appropriate route signs before each intersection and on long straights (eg TDA1)
 - Use TD5 signs to advise end of detour
2. If detour to operate for more than 48 hours:
 - Use chevron sight board to direct traffic
 - Add destination signage as appropriate



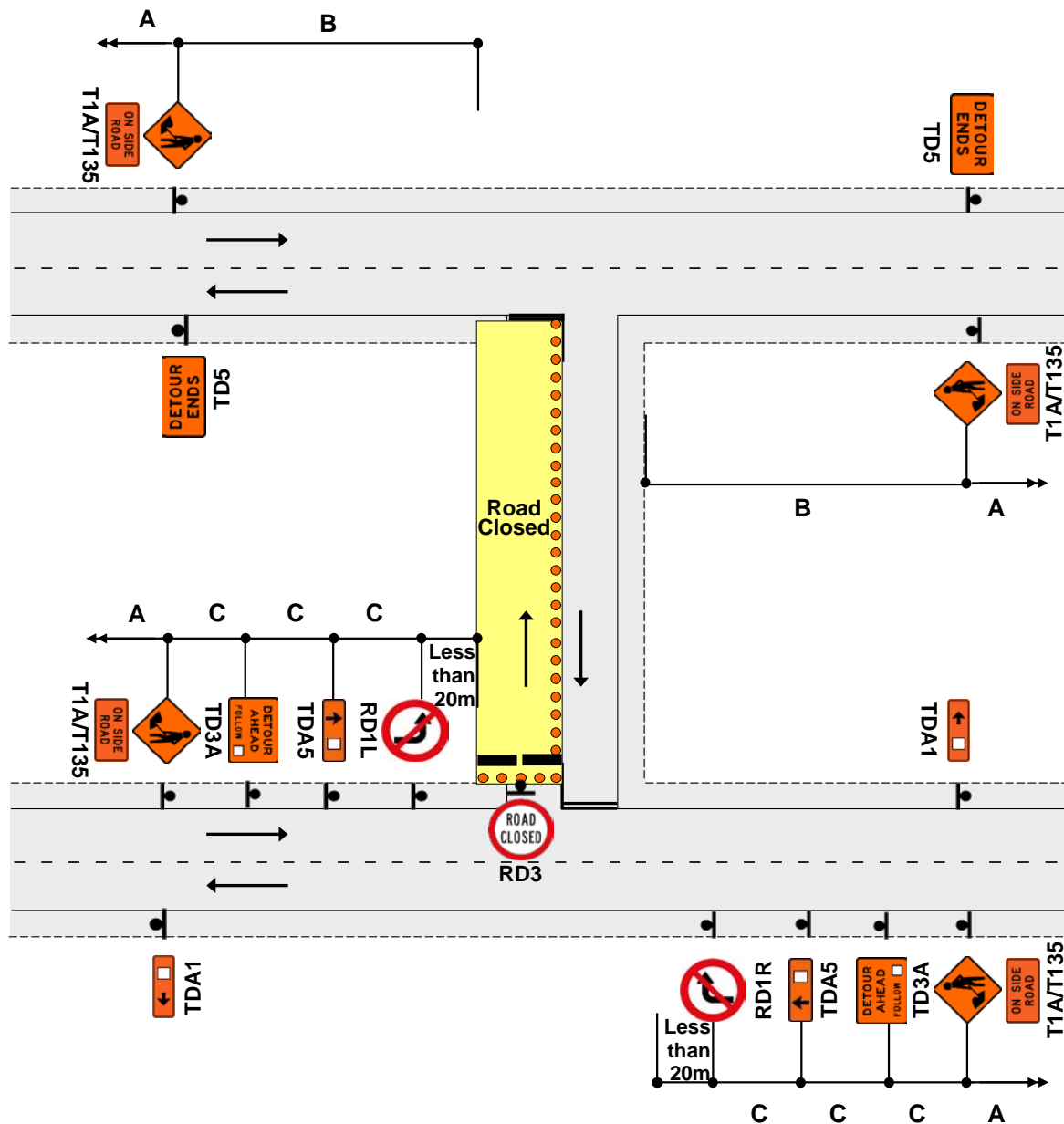





Notes

1. Signpost all intersections to return diverted traffic back to normal/intended route:
 - Use TD3A, B, C route signs to indicate detour ahead
 - Use appropriate TD(A, B, C) 1, 2, 3, 4, 5, 6 route signs before each intersection
 - Use TD5 signs to advise end of detour
2. Detour route plan required with this layout



Notes

1. This diagram is for initial response only. Appropriate long term TTM must be installed as soon as practical
 2. Use one of the following signs and/or supplementary plates:
- | | | |
|--------|--|------------------|
| T211 |  | Flooding |
| T212 |  | Washout |
| TR1L/R |  | Slips |
| TR2 |  | Slippery Surface |
| TR4 |  | Uneven Surface |
3. If necessary, erect TG4 DRY YOUR BRAKES sign
 4. Delineate hazard if hazard extends onto lane
 5. Use TSLs if required by TSL decision matrix
 6. The T144 X0km/h AHEAD sign is optional

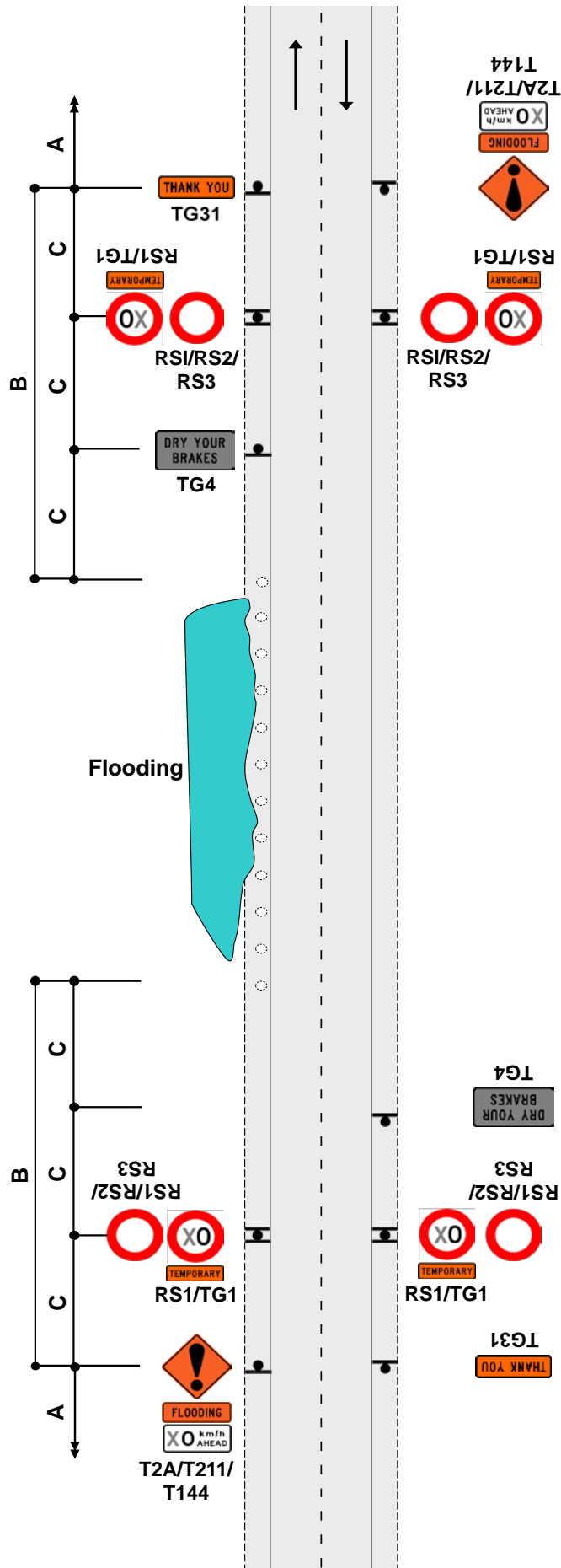

TWO-WAY TWO-LANE ROAD - Other hazard

Tree felling
Less than 2 x tree height

J2.26a
Level 1

Notes

1. Extend advance warning signs towards on-coming traffic beyond any expected traffic queues
2. Use supplementary T121 sign Next Xkm for long tree worksites

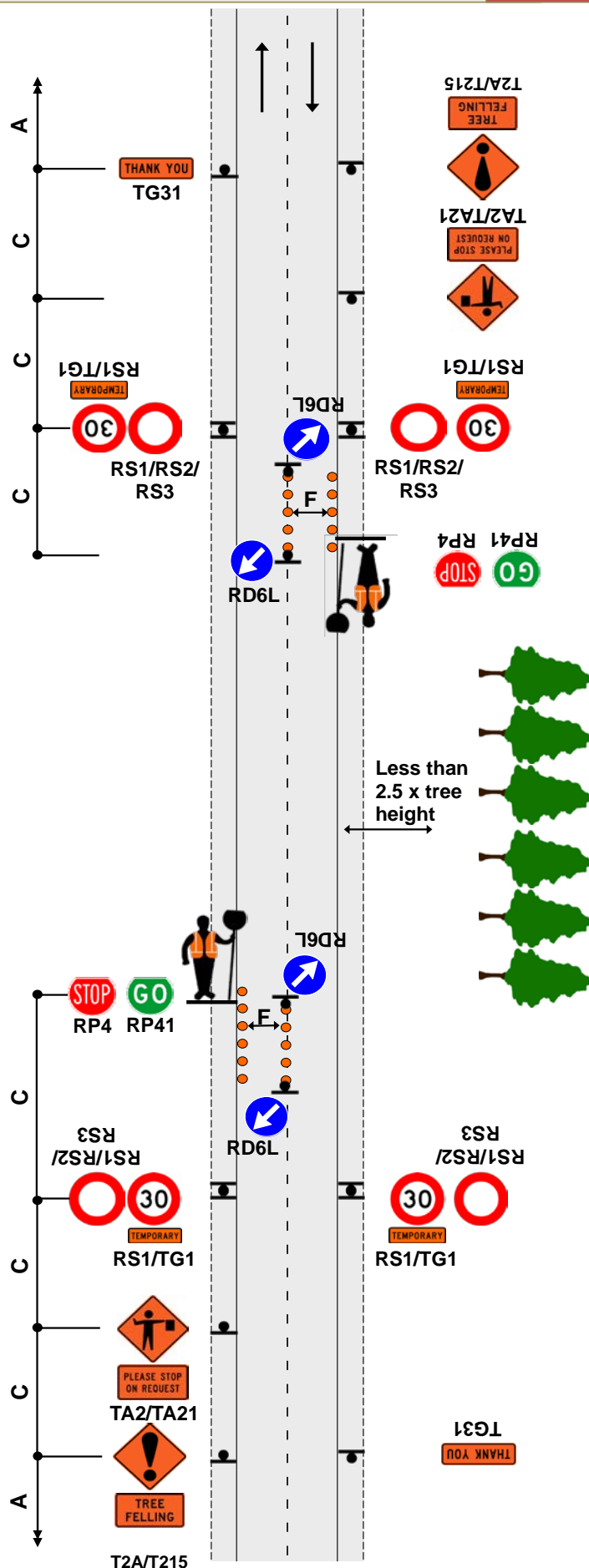

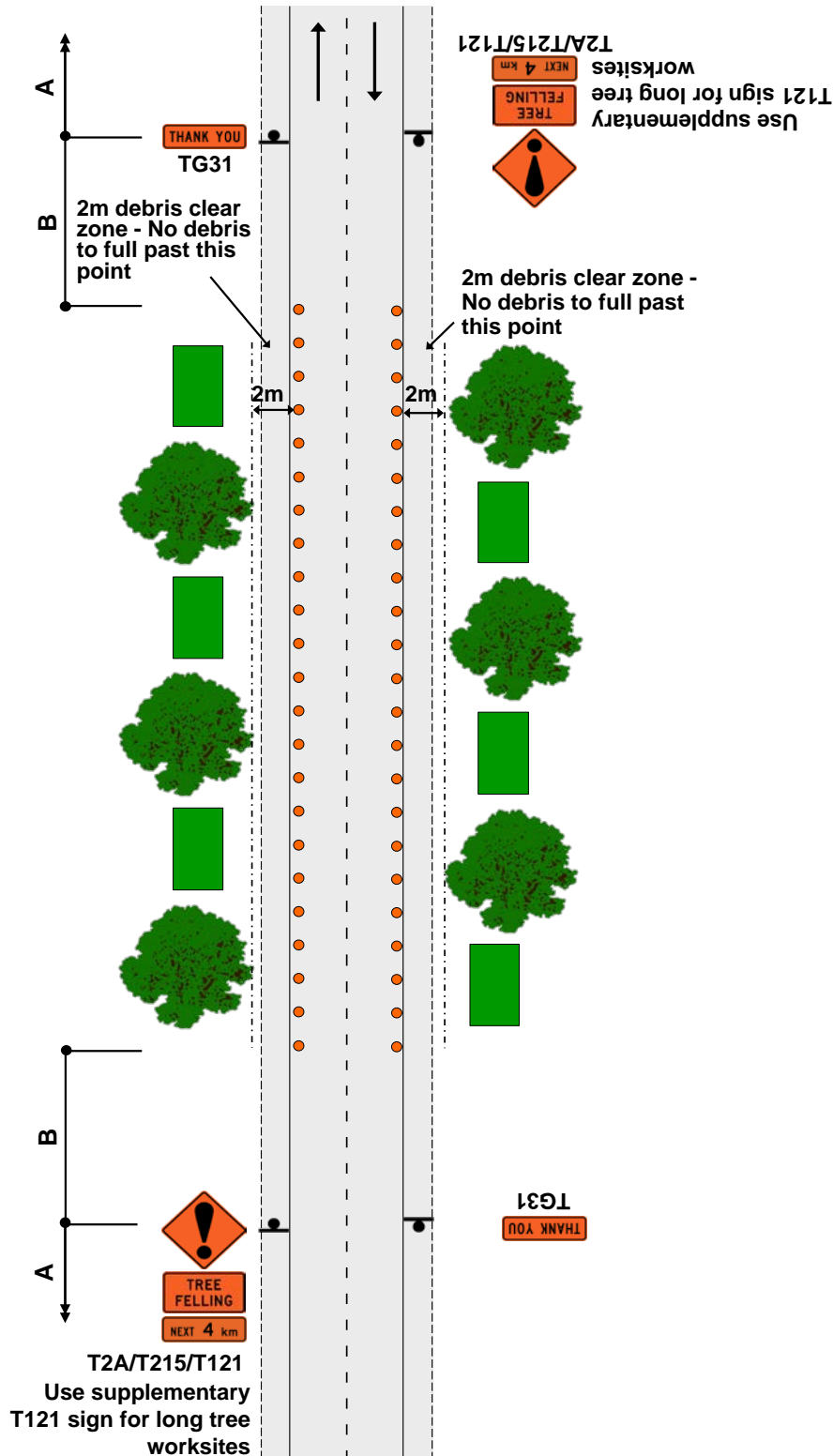

Notes

1. Create pedestrian protection where needed – use barricades/cones
2. Instruct all staff to watch for, and control, pedestrians
3. All plant to use amber flashing beacon
4. Staff to wear high-visibility vests
5. Use RP4/RP41 and TA2/TA21 signs, Stop/Go paddle operators to control traffic where needed, e.g. felling into/near live lane. TSL signage (30km/h) in tandem with Stop/Go operation
6. Keep road users away from trees when felling (2.5 x tree height distance)

Notes

1. Approval required from TMC where permanent speed exceeds 50km/h
2. All plant to use amber flashing beacon(s)
3. High-visibility jackets to be worn at all times
4. Shadow vehicle required when any part of the operation encroaches onto the shoulder and/or carriageway

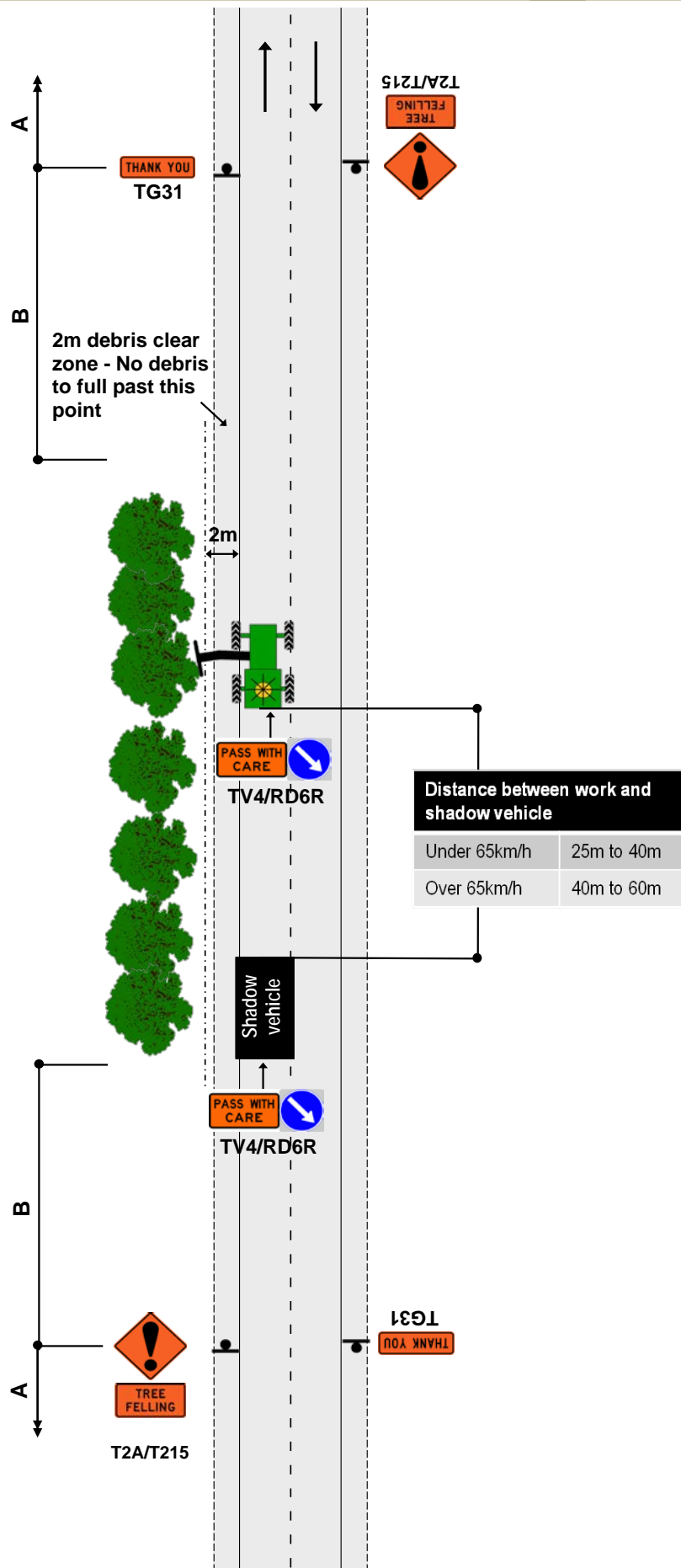



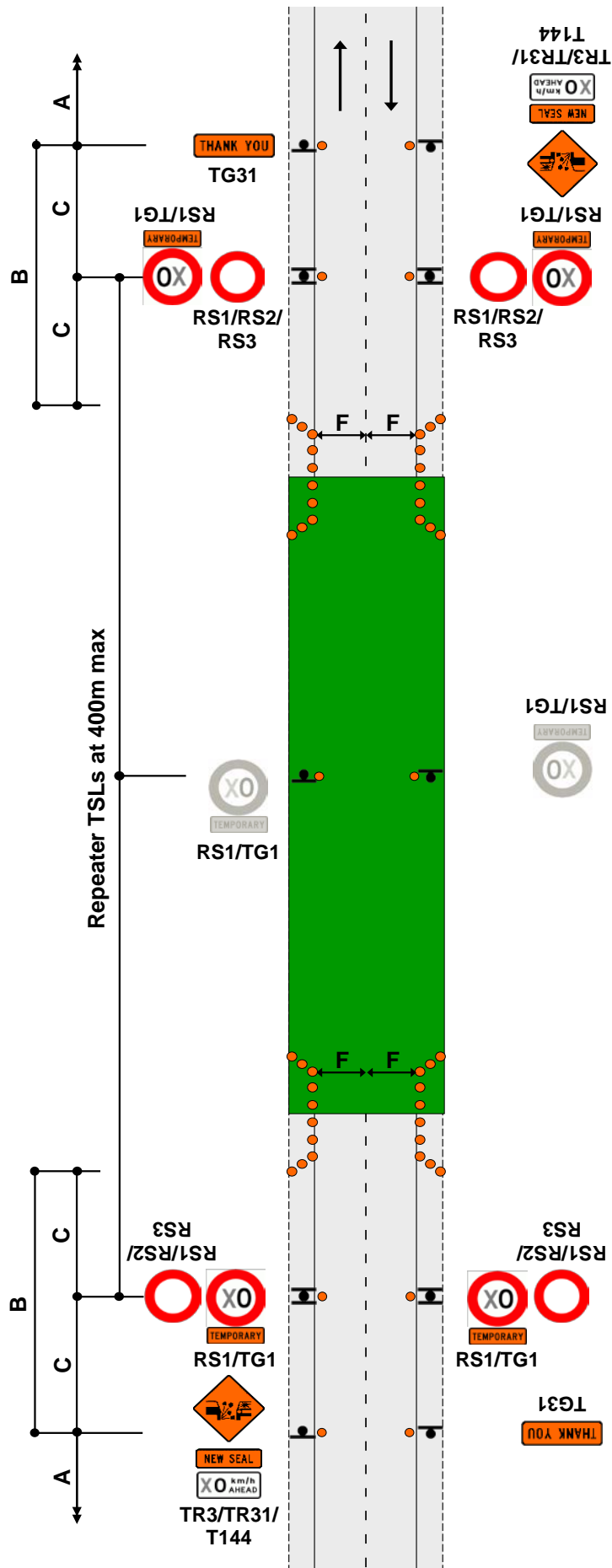

Notes

1. Use TSLs if required by TSL decision matrix
2. Worksites need positive traffic management to ensure all road users travel at the TSL
3. Use cones to form a threshold treatment at the start of the new seal. Minimum of 10 cones at 5m centres
4. Cones on the trafficked side of signs for sites to be left unattended overnight
5. TSLs to be repeated at not more than 400m intervals
6. The T144 X0km/h AHEAD sign is optional



Notes

1. This layout must not be used on an alignment with horizontal curves (corners) or when repairs are carried out on or near horizontal curves. See TMD F2.29
2. On long worksites, use 'Next X km' plates, repeat temporary speed limit signs at not more than 400m intervals
3. Signs for some alternative situations:

TR4		Uneven Surface
TR2		Slippery Surface
TR3		Gravel/Unsealed Surface
TR31		New Seal
TR32		Seal Repairs

4. Cones to be placed on left of carriageway for full length of hazard at 10m centres or at least 3 cones, whichever is the greater
5. Cones on the trafficked side of signs for sites to be left unattended overnight
6. Worksites need positive traffic management to ensure all road users travel at the TSL
7. Use TSLs if required by TSL decision matrix
8. The T144 X0km/h AHEAD sign is optional

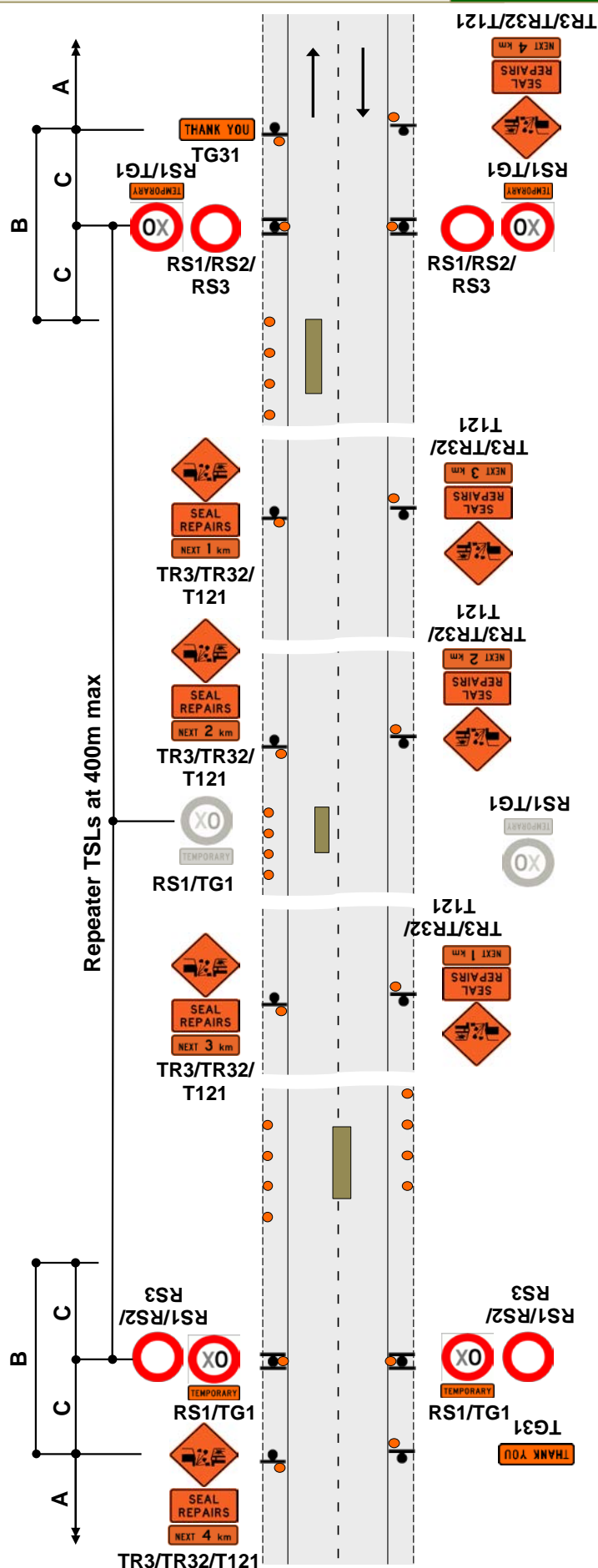

Notes

1. For work such as raised service covers which need protection while concrete sets
2. *Calculation of taper length for lateral shift of less than 3.5m is:
$$\frac{W \times G}{3.5}$$

W = Width of lane
G = Taper length in metres from the level 1 layout distance table
3. Use TSLs if required by TSL decision matrix
4. The T144 X0km/h AHEAD sign is optional

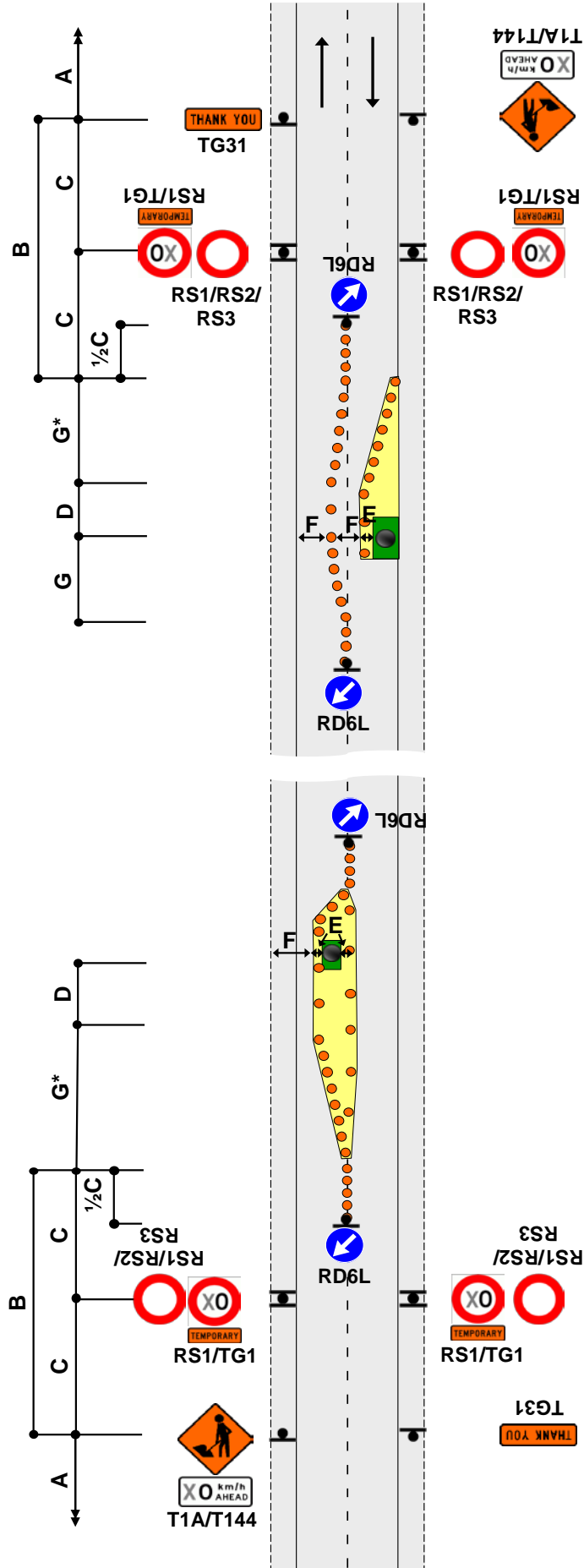

Notes

1. Cones on edge of seal - minimum 3 cones, maximum spacing 10m, next to each repair area
2. Cover any curve advisory speed sign that has a higher speed than the TSL
3. Use TSLs if required by TSL decision matrix
4. The T144 X0km/h AHEAD sign is optional

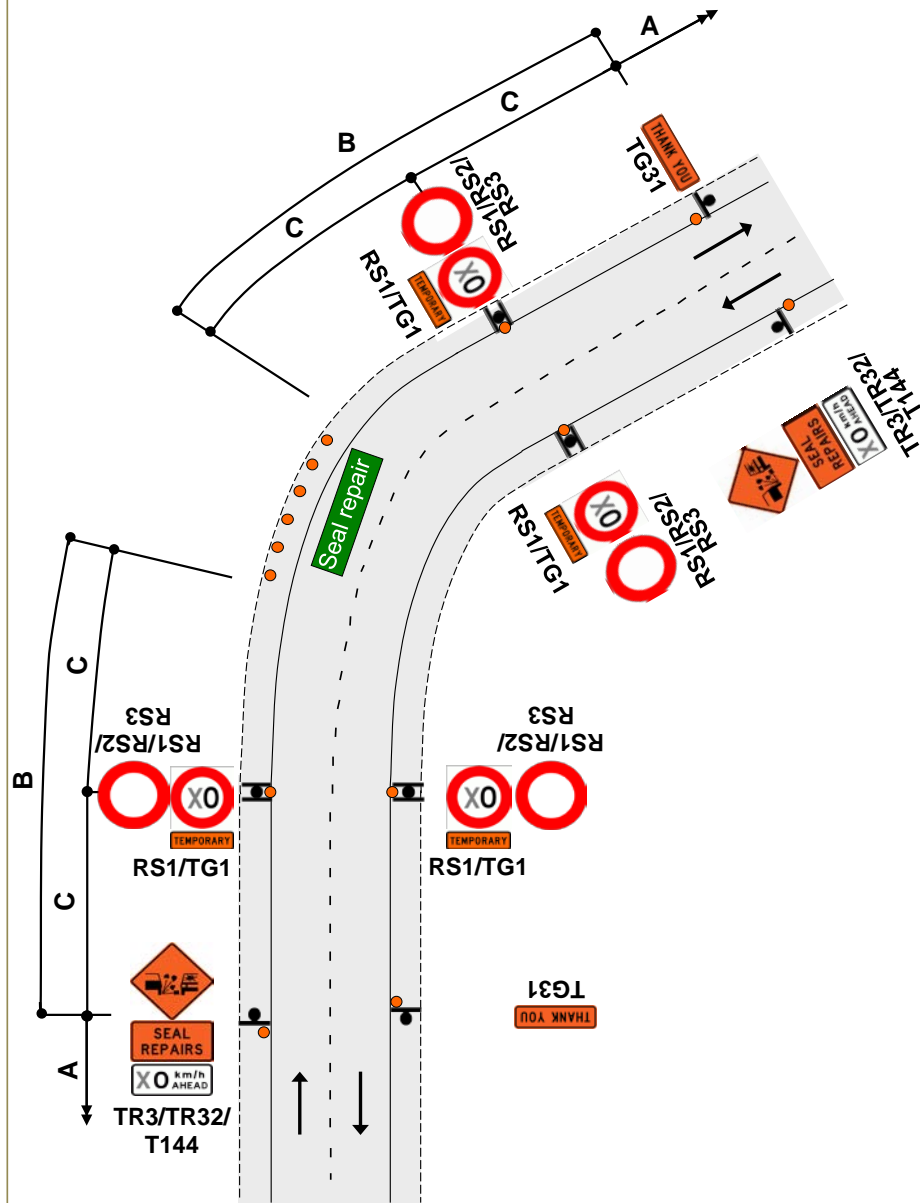

Notes

1. Use TSLs if required by TSL decision matrix
2. On roads with a permanent speed limit of 100km/h, cones are required from the TSL to the taper if the speed is reduced by more than 30km/h
3. The T144 X0km/h AHEAD sign is optional

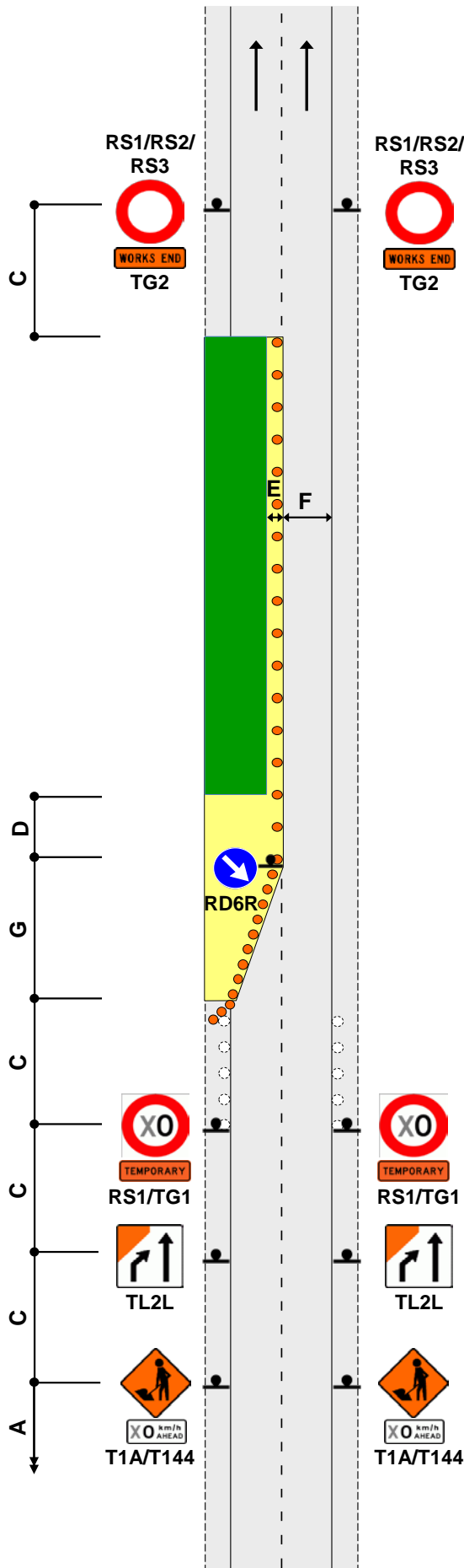

Notes

1. Use TSLs if required by TSL decision matrix
2. On roads with a permanent speed limit of 100km/h, cones are required from the TSL to the taper if the speed is reduced by more than 30km/h
3. The T144 X0km/h AHEAD sign is optional

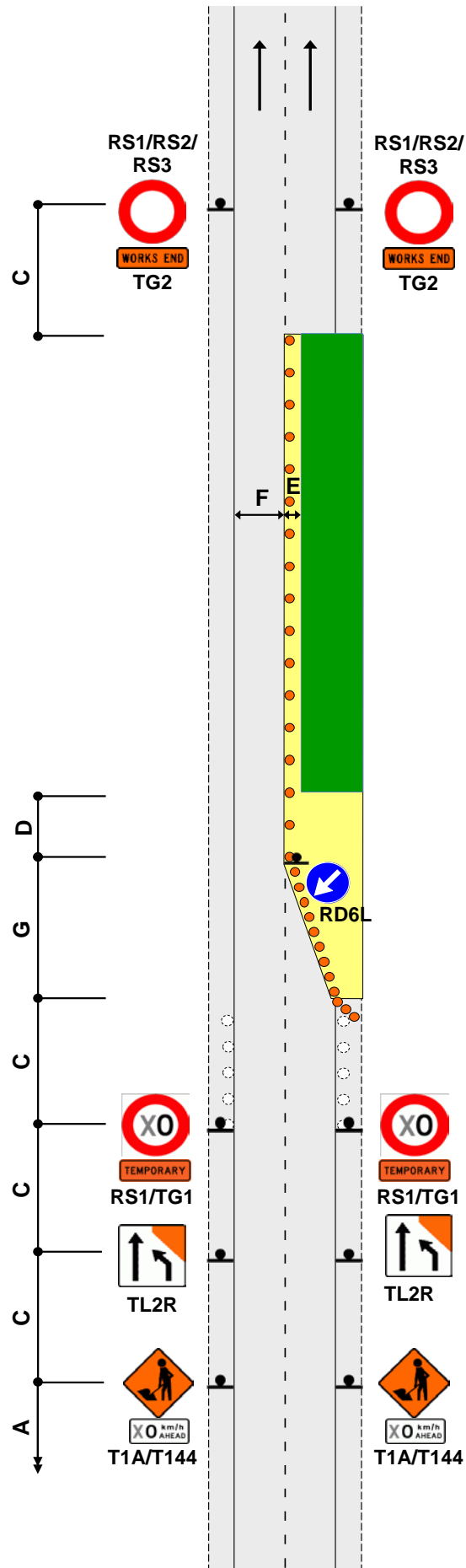

Notes

1. Cones required opposite closure if edge of carriageway not clearly defined
2. *Calculation of taper length for lateral shift of less than 3.5m is:
$$\frac{W \times G}{3.5}$$

W = Width of lateral shift
G = Taper length in metres from the level 1 layout distance table
3. To allow heavy vehicles to manoeuvre, cones in the channel must be offset by at least 10m where the direction changes. Refer C8.2.12
4. Use TSLs if required by TSL decision matrix
5. On roads with a permanent speed limit of 100km/h, cones are required from the TSL to the taper if the speed is reduced by more than 30km/h
6. The T144 X0km/h AHEAD sign is optional

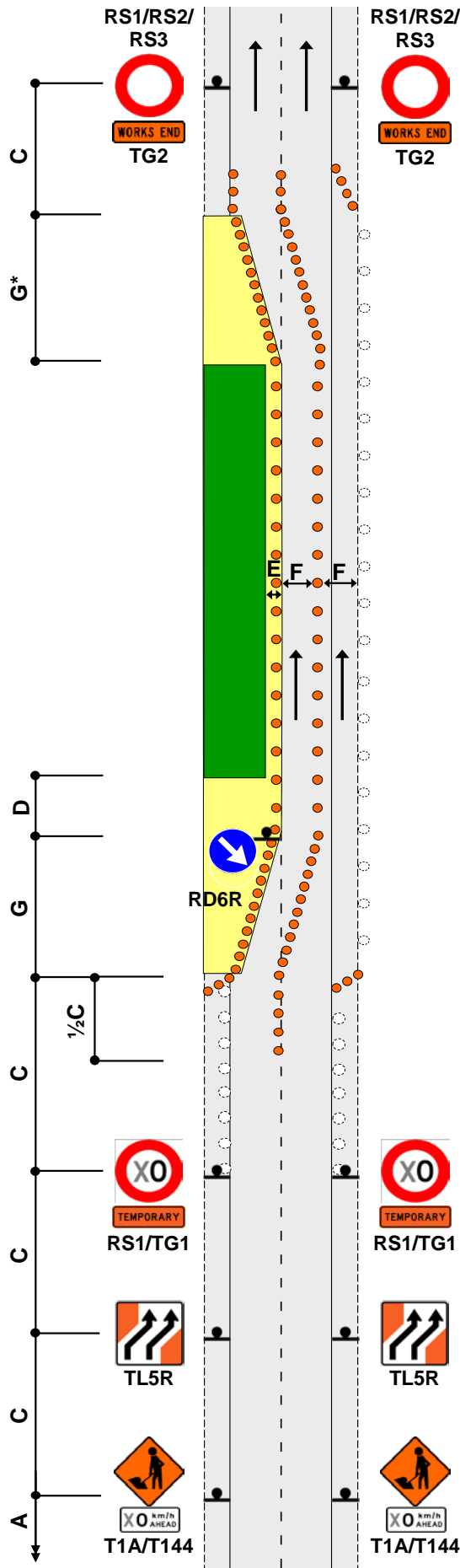

Notes

- Where a physical centre median exists which is more than 2m wide, signs and cones may be positioned on the median
- *Calculation of taper length for lateral shift of less than 3.5m is:
$$\frac{W \times G}{3.5}$$

W = Width of lateral shift
G = Taper length in metres from the level 1 layout distance table
- Cones must be placed behind any away-facing signs for rear-side visibility
- To allow heavy vehicles to manoeuvre, cones in the channel must be offset by at least 10m where the direction changes. Refer C8.2.12
- Use PN11 No Stopping signs, if necessary
- Use TSLs if required by TSL decision matrix
- On roads with a permanent speed limit of 100km/h, cones are required from the TSL to the taper if the speed is reduced by more than 30km/h
- The T144 X0km/h AHEAD sign is optional

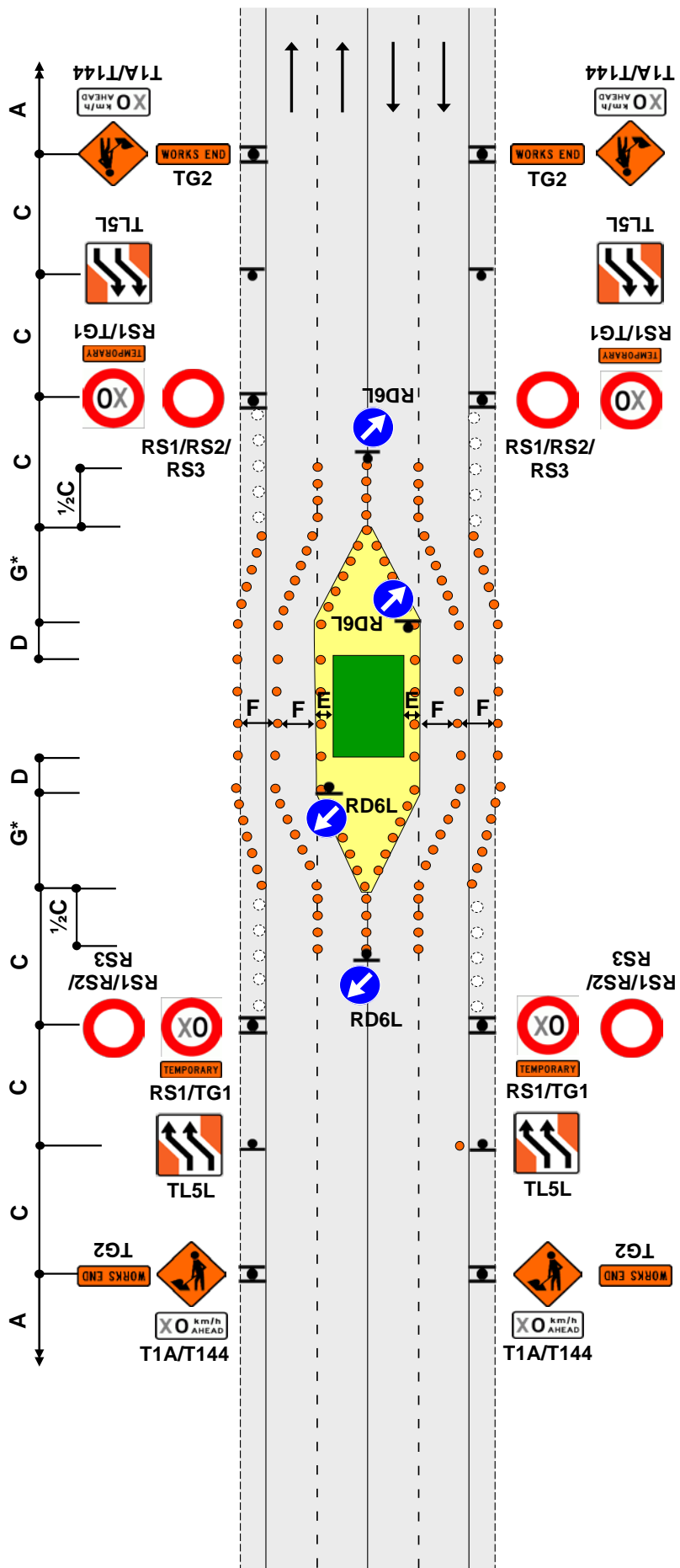

TWO-LANE DIVIDED OR TWO-LANE ONE-WAY ROAD

Lanes diverted

J2.33a

Level 1

Notes

1. Where a physical centre median exists which is more than 2m wide, signs and cones may be positioned on the median
2. *Calculation of taper length for lateral shift of less than 3.5m is:

$$\frac{W \times G}{3.5}$$

W = Width of lateral shift
 G = Taper length in metres from the level 1 layout distance table
3. Cones must be placed behind any away-facing signs for rear-side visibility
4. To allow heavy vehicles to manoeuvre, cones in the channel must be offset by at least 10m where the direction changes. Refer C8.2.12
5. Use PN11 No Stopping signs, if necessary
6. Use TSLs if required by TSL decision matrix
7. On roads with a permanent speed limit of 100km/h, cones are required from the TSL to the taper if the speed is reduced by more than 30km/h
8. The T144 X0km/h AHEAD sign is optional

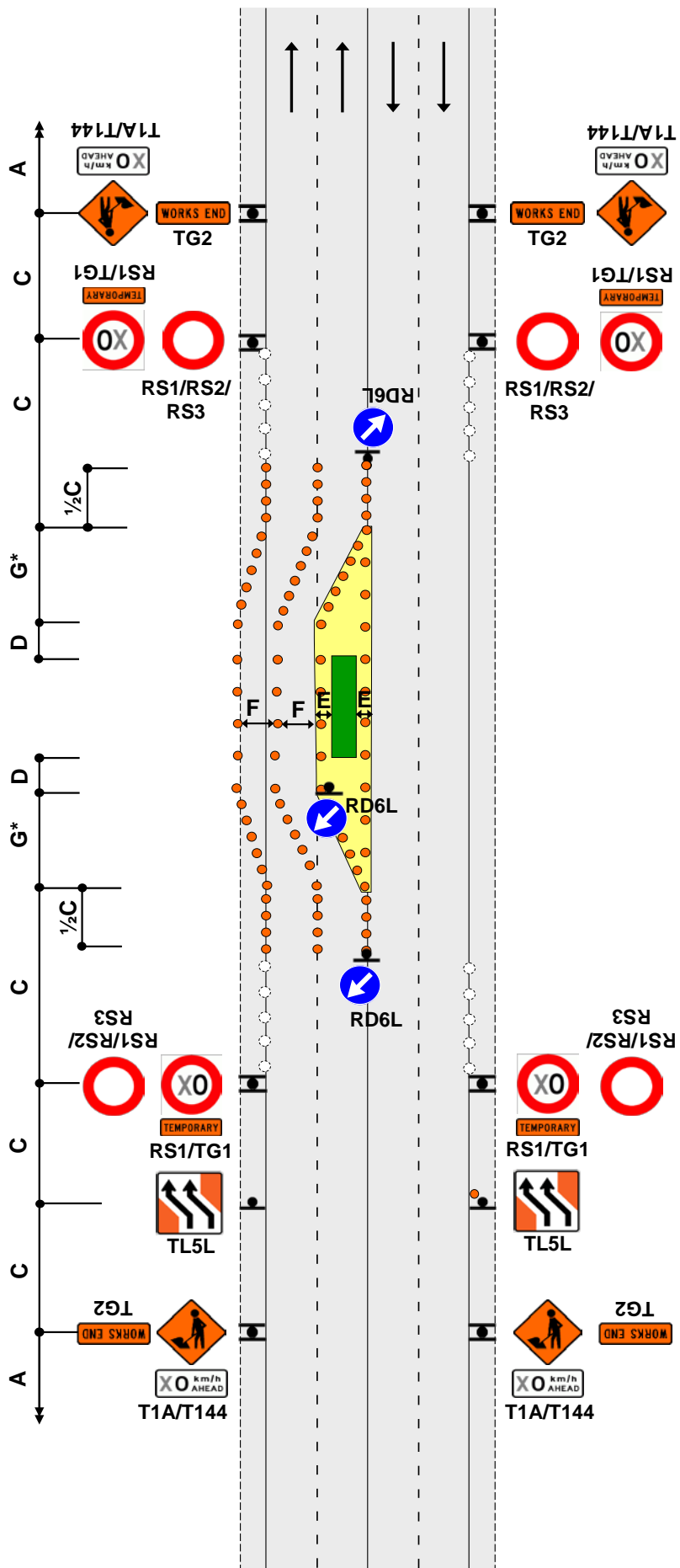

Notes

1. Use either TMD F2.32 or TMD F2.33 in preference to this TMD, unless their use would likely cause traffic delays
2. Cones are required on edge of the temporary lane opposite closure if road is not well defined
3. *Calculation of taper length for lateral shift of less than 3.5m is:
$$\frac{W \times G}{3.5}$$

W = Width of lateral shift
G = Taper length in metres from the level 1 layout distance table
4. To allow heavy vehicles to manoeuvre, cones in the channel must be offset by at least 10m where the direction changes. Refer C8.2.12
5. Use PN11 No Stopping signs, if necessary
6. Use TSLs if required by TSL decision matrix
7. On roads with a permanent speed limit of 100km/h, cones are required from the TSL to the taper if the speed is reduced by more than 30km/h
8. The T144 X0km/h AHEAD sign is optional

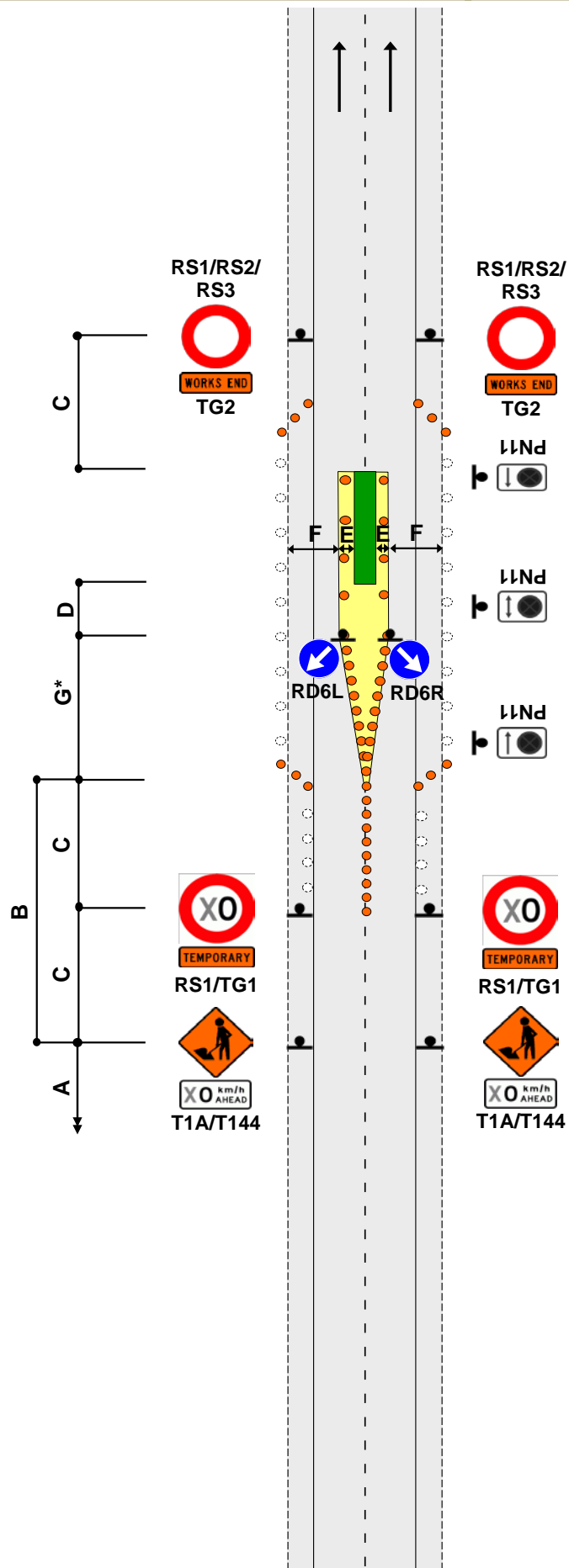

Notes

1. If the closure is on a passing lane, the start of the taper must be greater than 600m from the start of the passing lane (if this cannot be achieved then close the passing lane completely and cover all permanent passing lane signs)
2. If the end of the closure is within 600m of the end of a passing lane, continue to close the centre lane
3. Cones are required on edge of the temporary lane opposite closure if road is not well defined
4. Cones must be placed behind any away-facing signs for rear-side visibility
5. To allow heavy vehicles to manoeuvre, cones in the channel must be offset by at least 10m where the direction changes. Refer C8.2.12
6. Use TSLs as required by TSL decision matrix
7. On roads with a permanent speed limit of 100km/h, cones are required from the TSL to the taper if the speed is reduced by more than 30km/h
8. The T144 X0km/h AHEAD sign is optional

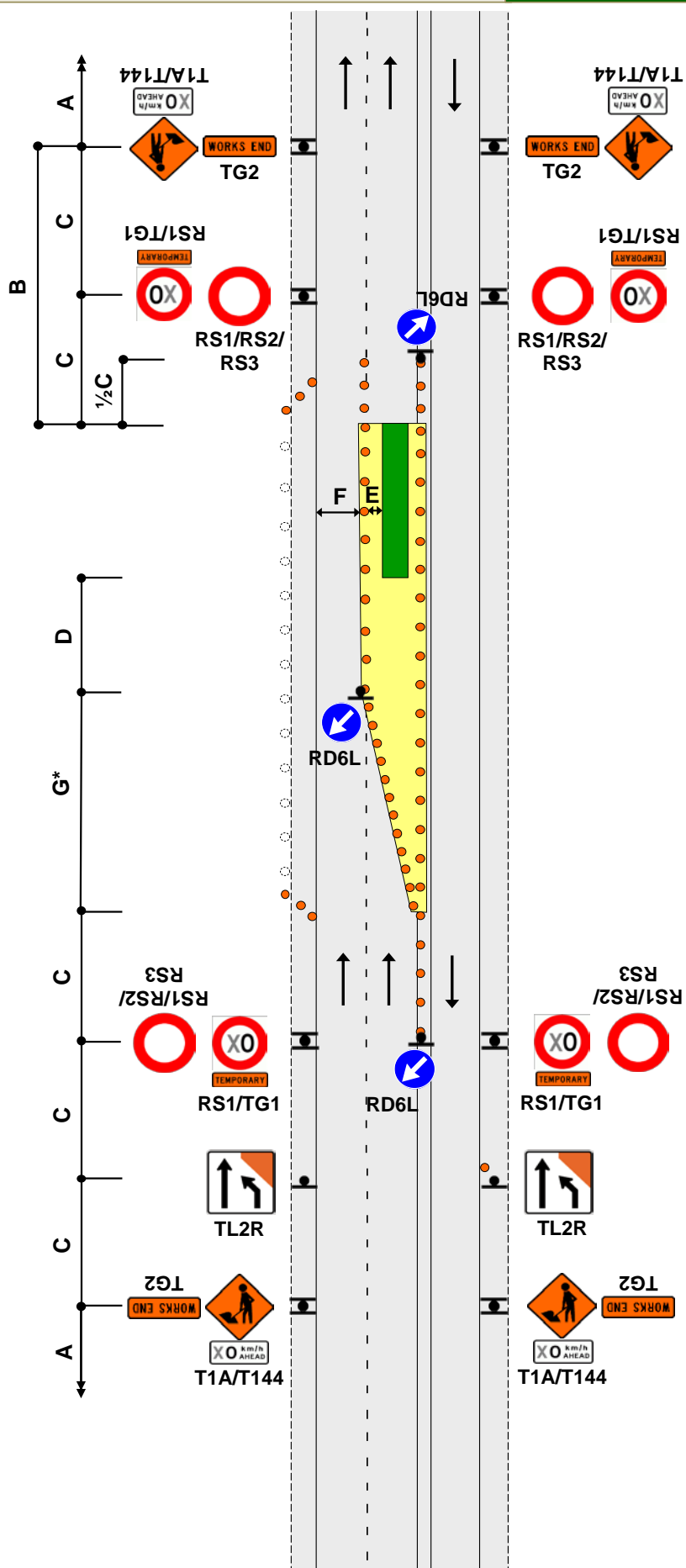

Notes

1. Refer to C8.2.17 if the closure is within a passing lane
2. Cones must be placed behind any away-facing signs for rear-side visibility
3. To allow heavy vehicles to manoeuvre, cones in the channel must be offset by at least 10m where the direction changes. Refer C8.2.12
4. Use TSLs as required by TSL decision matrix
5. On roads with a permanent speed limit of 100km/h, cones are required from the TSL to the taper if the speed is reduced by more than 30km/h
6. The T144 X0km/h AHEAD sign is optional

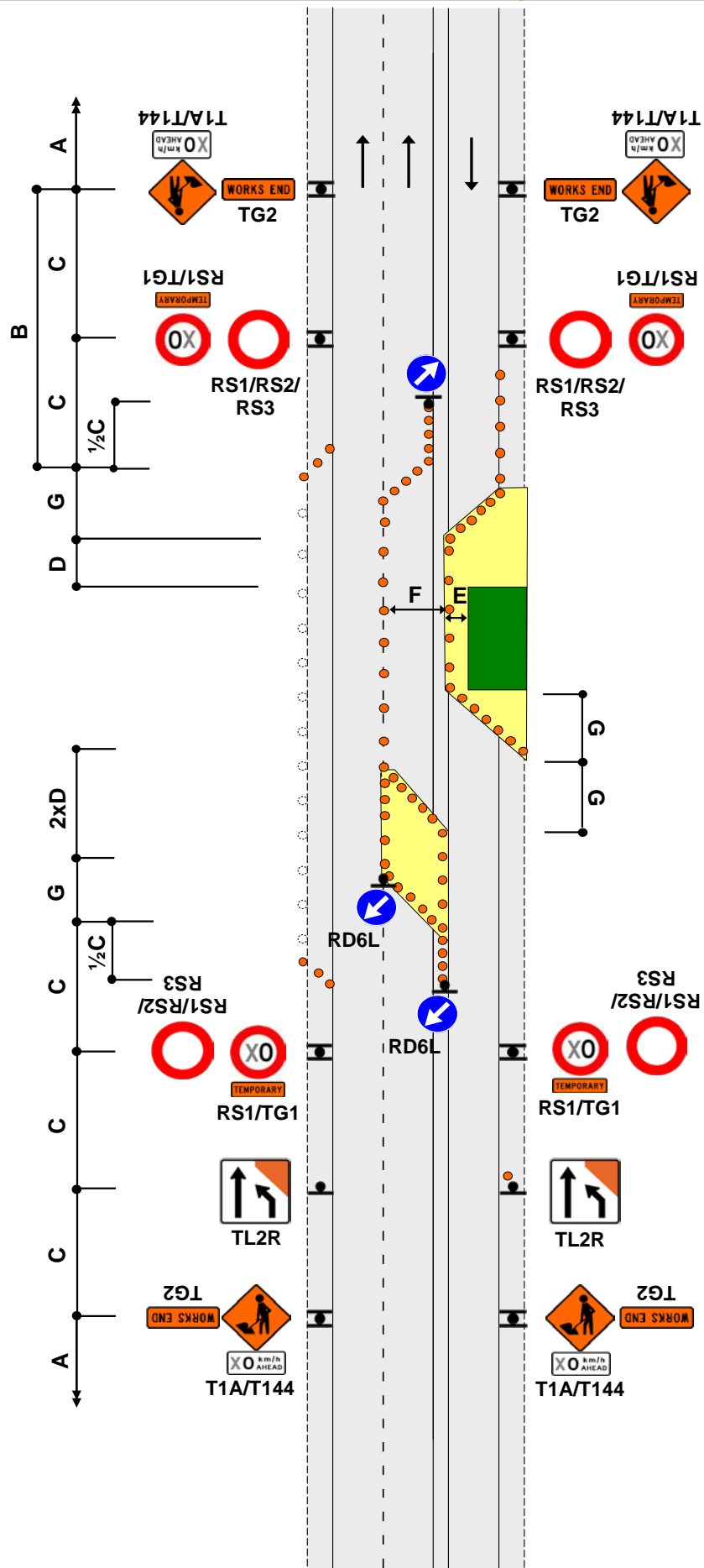

Notes

1. Where a physical centre median exists which is more than 2m wide, signs and cones may be positioned on the median
2. Cones must be placed behind any away-facing signs for rear-side
3. Use TSLs if required by TSL decision matrix
4. On roads with a permanent speed limit of 100km/h, cones are required from the TSL to the taper if the speed is reduced by more than 30km/h
5. The T144 X0km/h AHEAD sign is optional

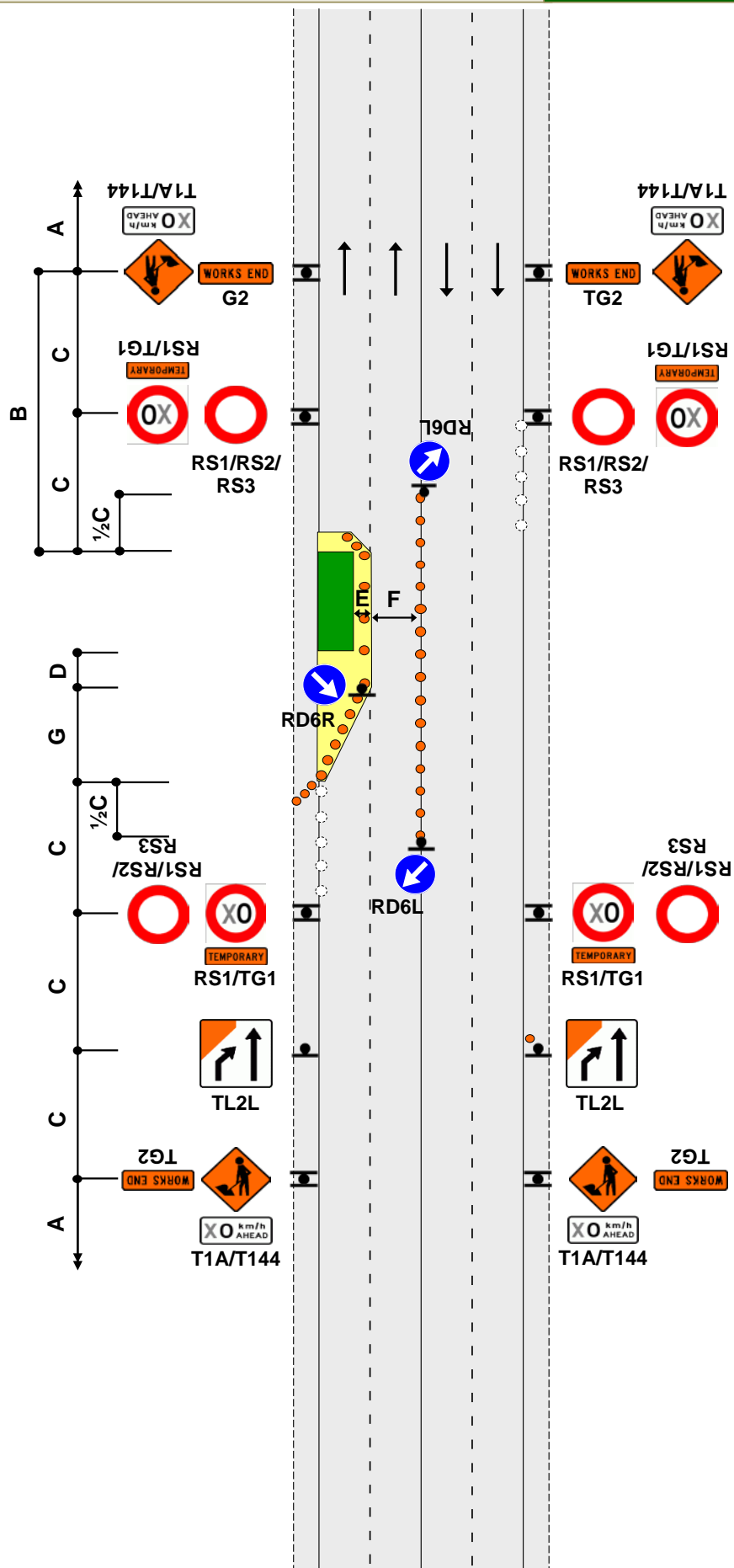

TWO-WAY FOUR-LANE ROAD

Two-lane closure
One-lane contraflow

F2.38

Level 1

Notes

1. Use PN11 No Stopping signs, if necessary
2. *Calculation of taper length for lateral shift of less than 3.5m is:
$$\frac{W \times G}{3.5}$$

W = Width of lateral shift
G = Taper length in metres from the level 1 layout distance table
3. Cones must be placed behind any away-facing signs for rear-side visibility
4. To allow heavy vehicles to manoeuvre, cones in the channel must be offset by at least 10m where the direction changes. Refer C8.2.12
5. Use TSLs if required by TSL decision matrix
6. On roads with a permanent speed limit of 100km/h, cones are required from the TSL to the taper if the speed is reduced by more than 30km/h
7. The T144 X0km/h AHEAD sign is optional

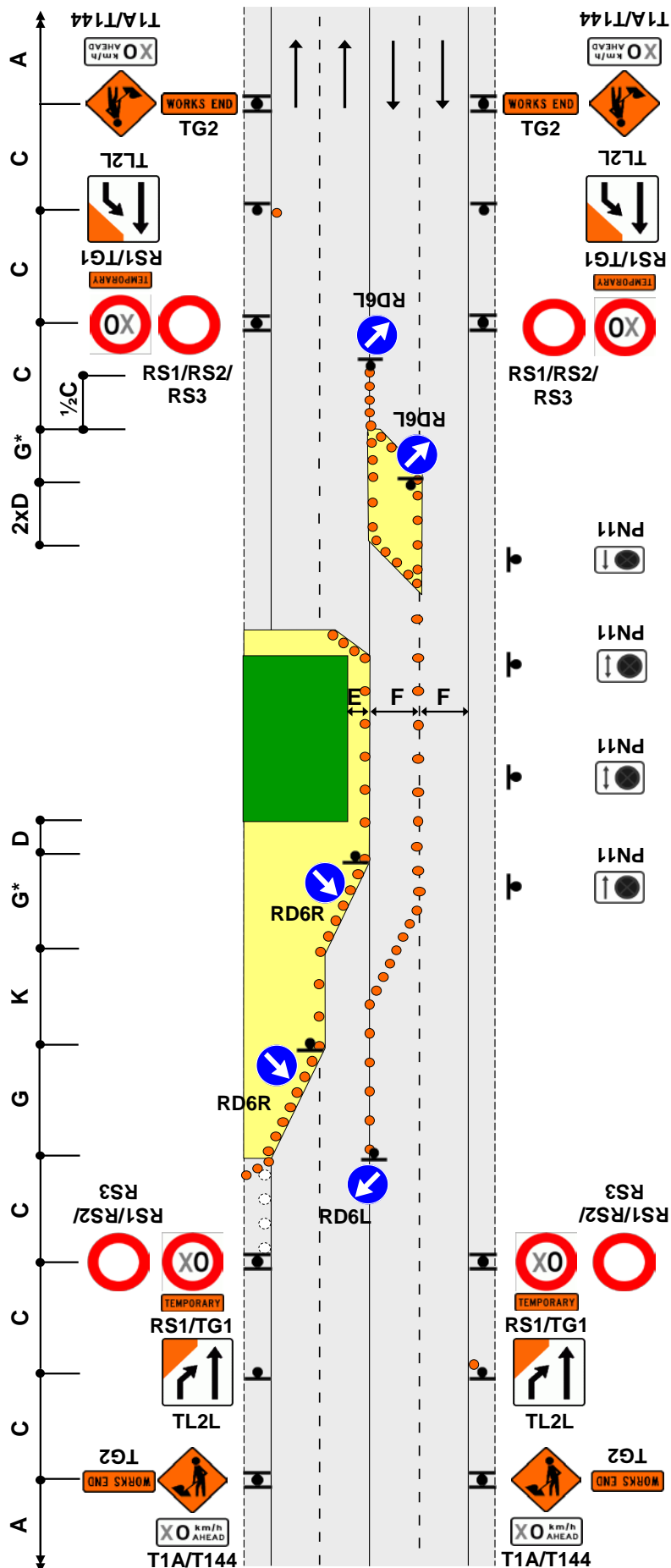

Notes

1. Cones must be placed behind any away-facing signs for rear-side visibility
2. Cones are required on edge of the temporary lane opposite closure if road is not well defined
3. To allow heavy vehicles to manoeuvre, cones in the channel must be offset by at least 10m where the direction changes. Refer C8.2.12
4. Use TSLs if required by TSL decision matrix
5. On roads with a permanent speed limit of 100km/h, cones are required from the TSL to the taper if the speed is reduced by more than 30km/h
6. The T144 X0km/h AHEAD sign is optional

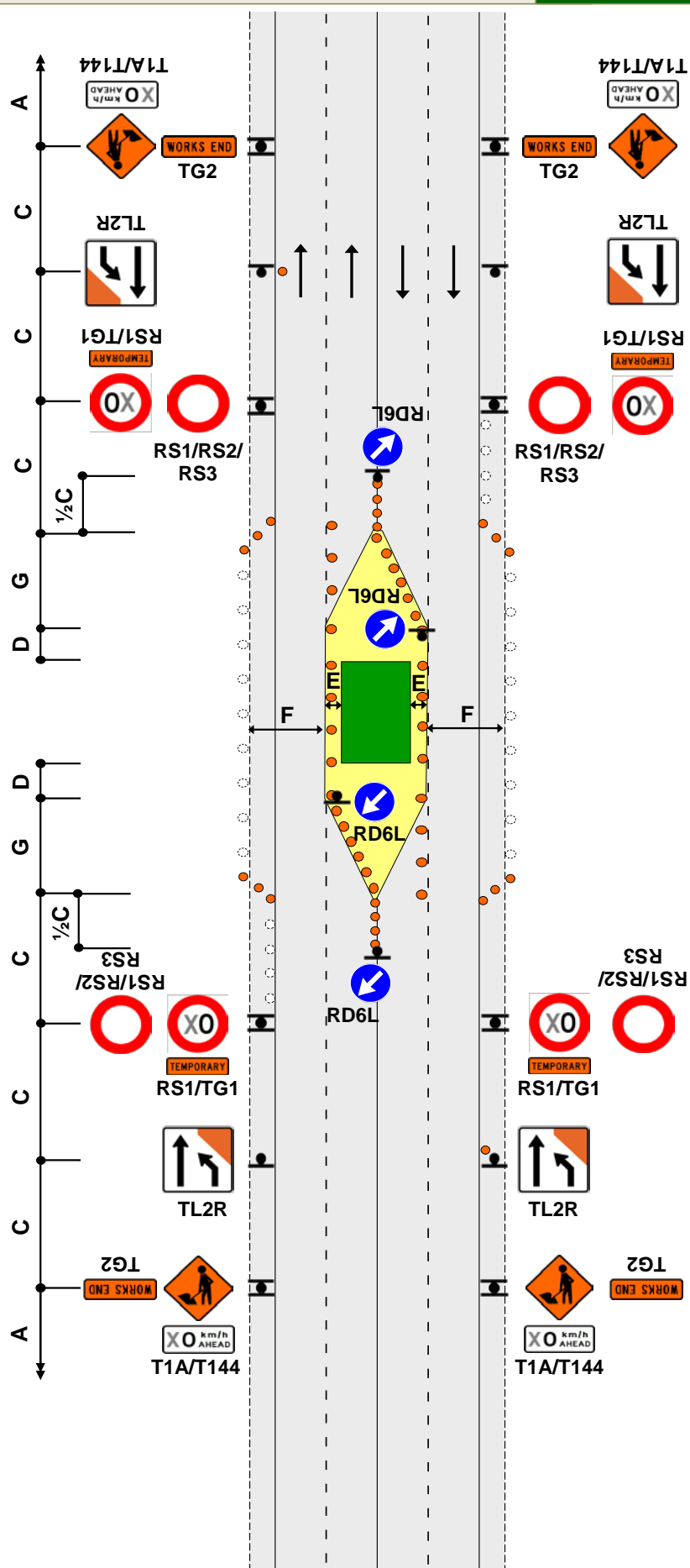

TWO-WAY FOUR-LANE ROAD
Right lane closure

J2.39a
Level 1

Notes

- Where a physical centre median exists which is more than 2m wide, signs and cones may be positioned on the median
- *Calculation of taper length for lateral shift of less than 3.5m is:
$$\frac{W \times G}{3.5}$$

W = Width of lateral shift
G = Taper length in metres from the level 1 layout distance table
- If the closure is on a passing lane, the start of the taper must be greater than 600m after the start of the passing lane (if this cannot be achieved then close the passing lane completely and cover all permanent passing lane signs)
- If the end of the closure is within 600m of the end of a passing lane, continue to close the centre lane
- Cones must be placed behind any away-facing signs for rear-side visibility
- Use TSLs as required by TSL decision matrix
- Cones from TSL to taper are mandatory at over 65km/h (for positive traffic management)
- The T144 X0km/h AHEAD sign is optional

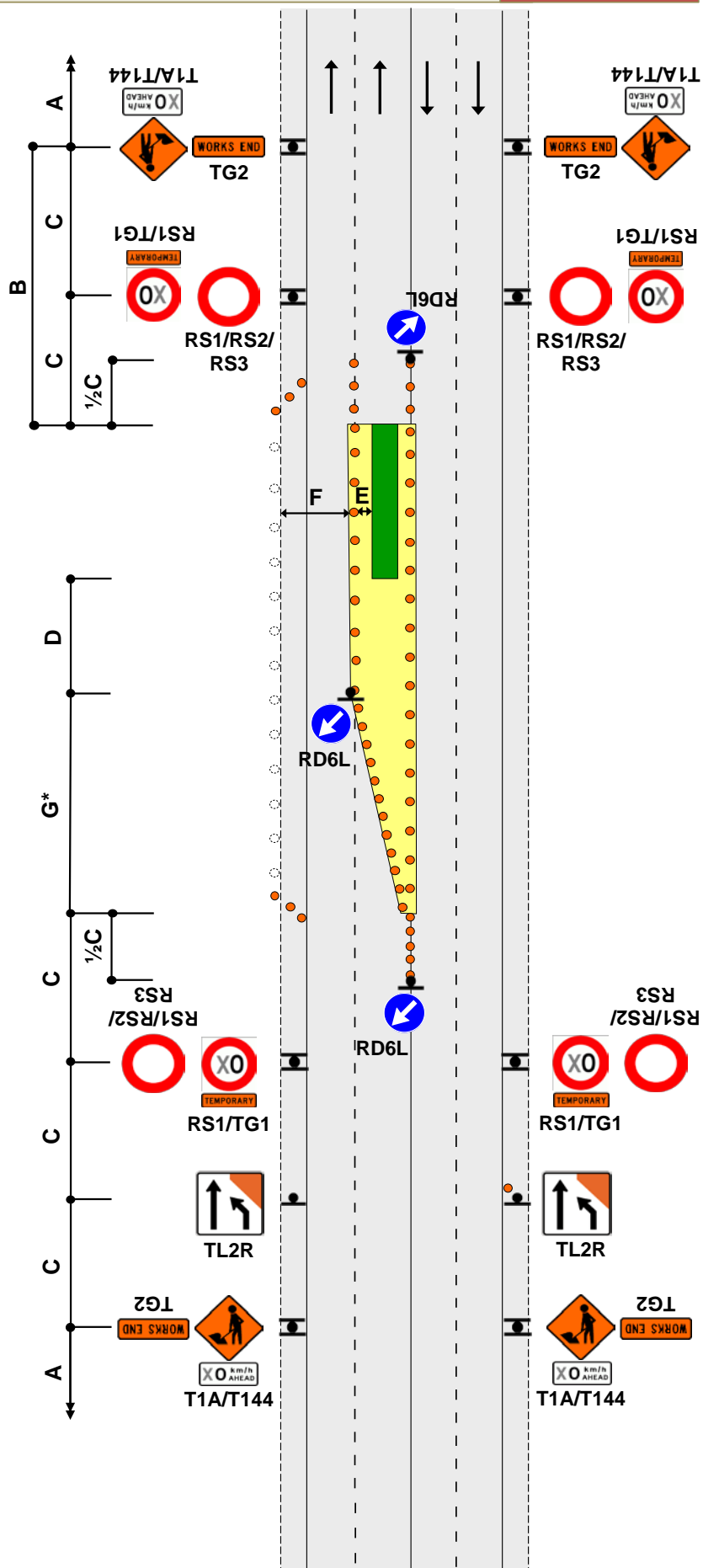

Notes

1. Full end taper may be added if required
2. Use TSLs if required by TSL decision matrix
3. On roads with a permanent speed limit of 100km/h, cones are required from the TSL to the taper if the speed is reduced by more than 30km/h
4. The T144 X0km/h AHEAD sign is optional

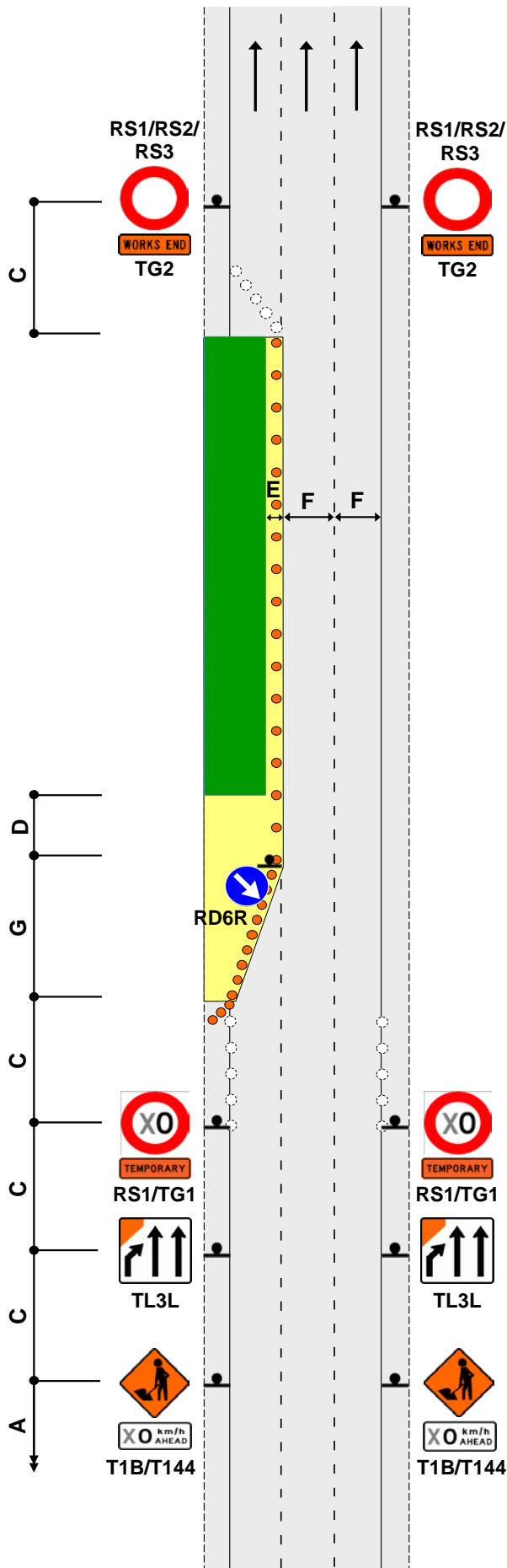

ONE-WAY THREE-LANE DIVIDED OR THREE-LANE ROAD

Two-lane closure
Left and centre lanes

F2.41

Level 1

Notes

1. Cones are required on edge of the temporary lane opposite closure if road is not well defined
2. Use TSLs if required by TSL decision matrix
3. On roads with a permanent speed limit of 100km/h, cones are required from the TSL to the taper if the speed is reduced by more than 30km/h
4. The T144 X0km/h AHEAD sign is optional

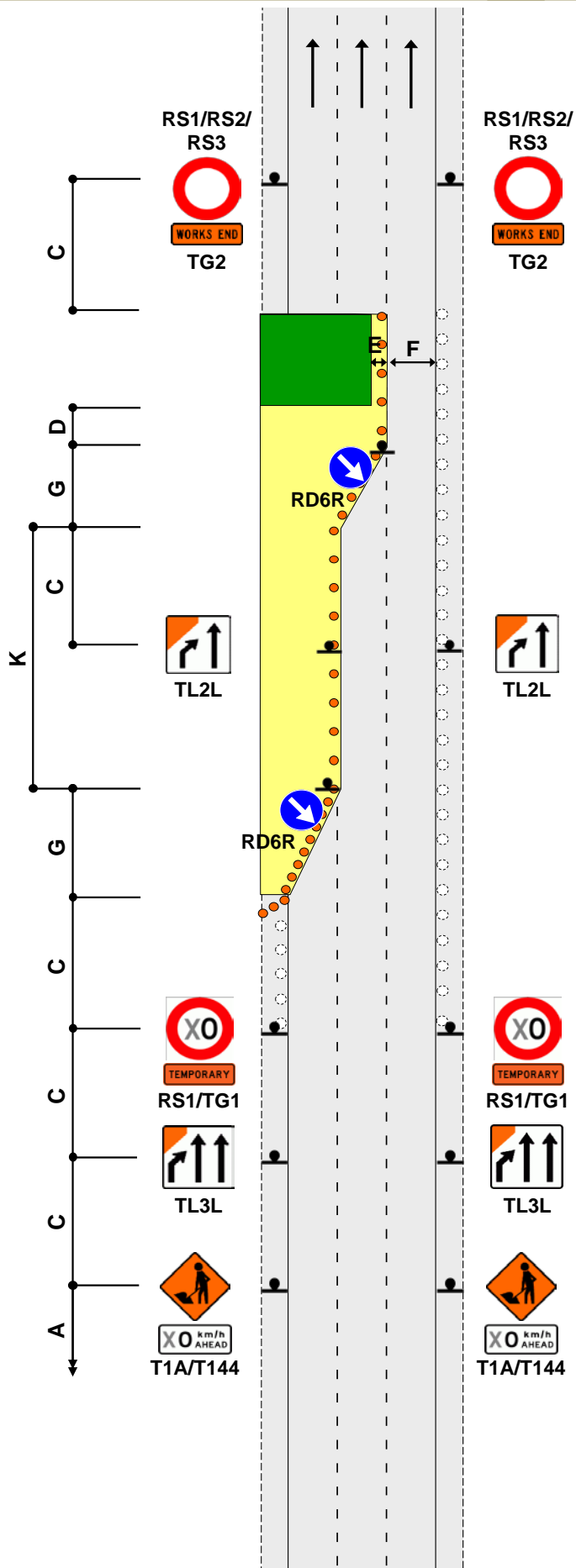

THREE-LANE DIVIDED OR THREE-LANE ONE-WAY ROAD

Two lane closure
Right and centre lanes

J2.41a

Level 1

Notes

1. Cones are required on edge of the temporary lane opposite closure if road is not well defined
2. Use TSLs if required by TSL decision matrix
3. On roads with a permanent speed limit of 100km/h, cones are required from the TSL to the taper if the speed is reduced by more than 30km/h
4. The T144 X0km/h AHEAD sign is optional

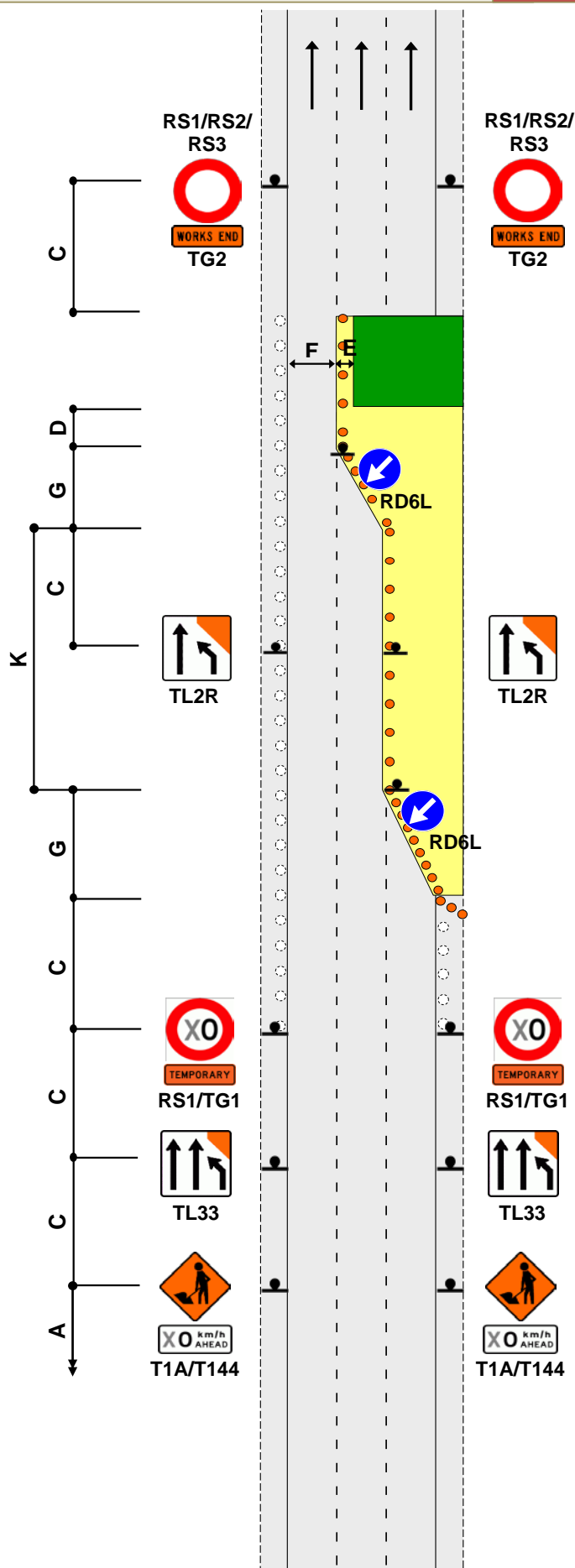

ONE-WAY THREE-LANE DIVIDED OR THREE-LANE ROAD

Two-lane closure
Two lane temporary diversion

F2.42

Level 1

Notes

1. Cones are required on edge of the temporary lane opposite closure if road is not well defined
2. *Calculation of taper length for lateral shift of less than 3.5m is:
$$\frac{W \times G}{3.5}$$

W = Width of lateral shift
G = Taper length in metres from the level 1 layout distance table
3. To allow heavy vehicles to manoeuvre, cones in the channel must be offset by at least 10m where the direction changes. Refer C8.2.12
4. Use TSLs if required by TSL decision matrix
5. On roads with a permanent speed limit of 100km/h, cones are required from the TSL to the taper if the speed is reduced by more than 30km/h
6. The T144 X0km/h AHEAD sign is optional

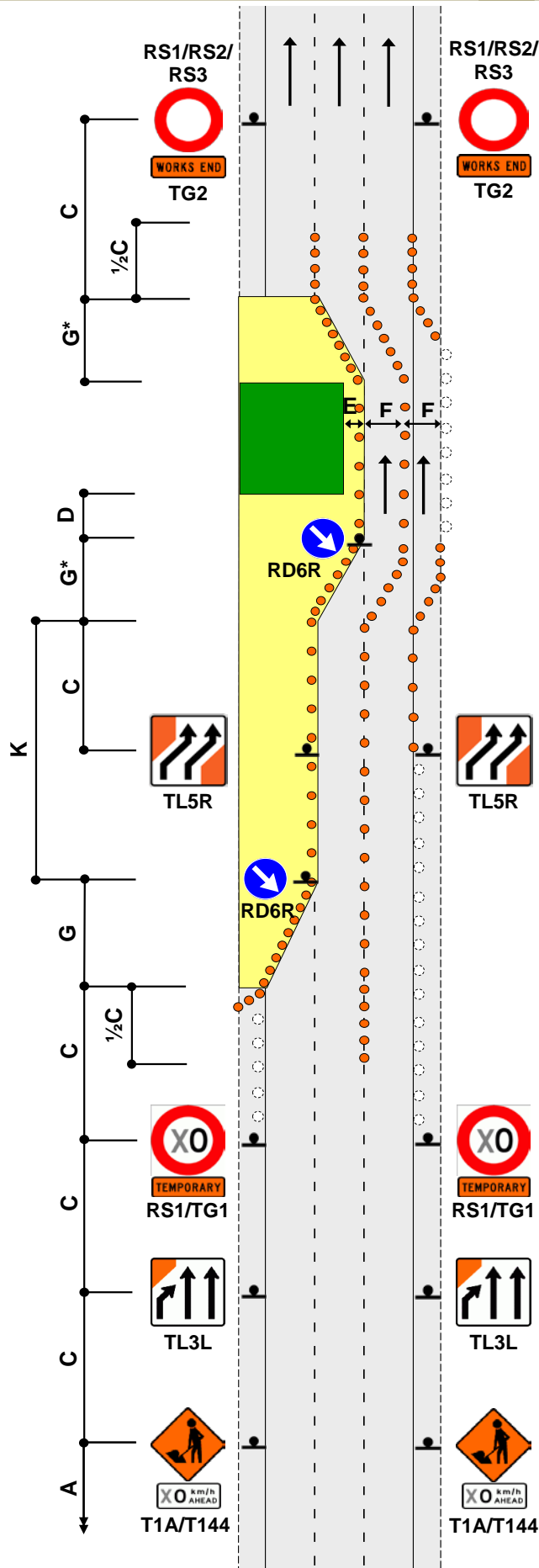

THREE LANES ONE WAY ROAD
 Middle lane closed on roads 50km/h or less
 Not for use on state highways

J2.42a
 Level 1

Notes

1. Not to be used on roads with permanent speed above 50km/h
2. Not to be used on state highways
3. Traffic must merge in one direction only
4. There must be a definite lane shift (either left or right)
5. Tapers must move traffic to the side of greatest capacity
6. Use either TMD F2.41 or TMD J2.41a in preference to this TMD, unless their use would likely cause traffic delays
7. Use TSLs if required by TSL decision matrix
8. The T144 X0km/h AHEAD sign is optional

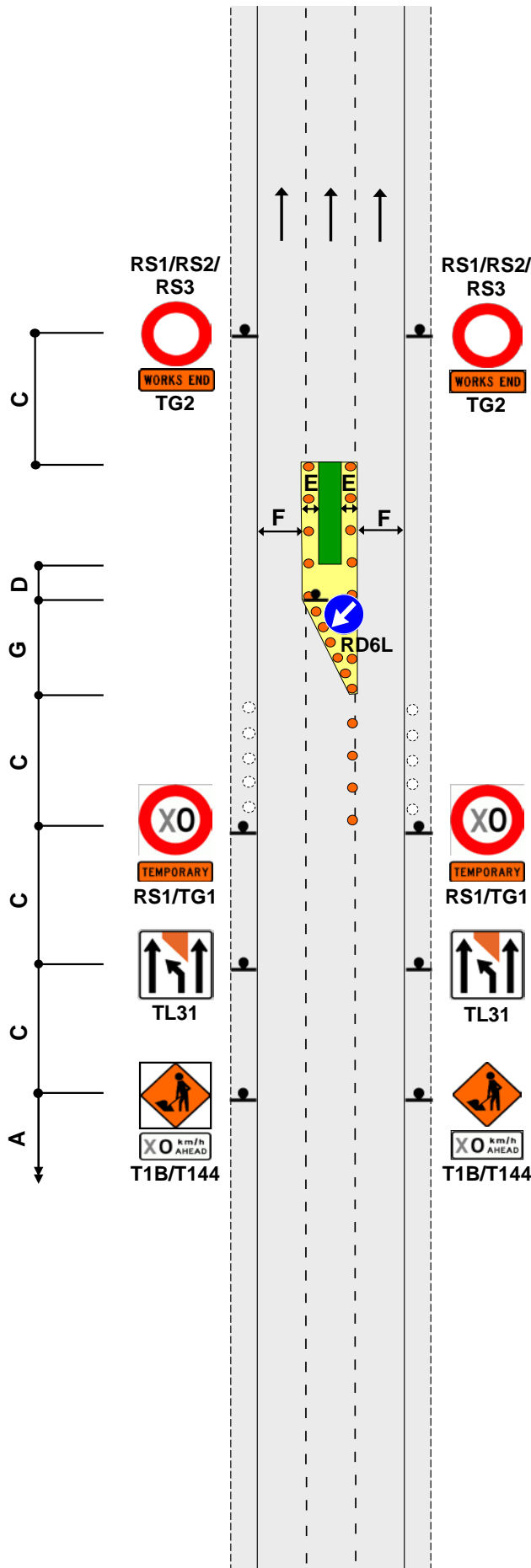

Notes

1. Work vehicle must be parked clear of the live lane and must have one, preferably two, flashing beacons operating
2. The work vehicle must have a rear mounted sign indicating the type of activity taking place
3. Rear mounted sign recommended but not mandatory on level LV
4. Activities taking place in front of the work vehicle must allow for a 10m roll ahead zone
5. Inspector can proceed onto the live lane if CSD exists and activity takes no longer than 5 minutes
6. The inspector must have CSD if on the live lane. A spotter can be used to attain CSD

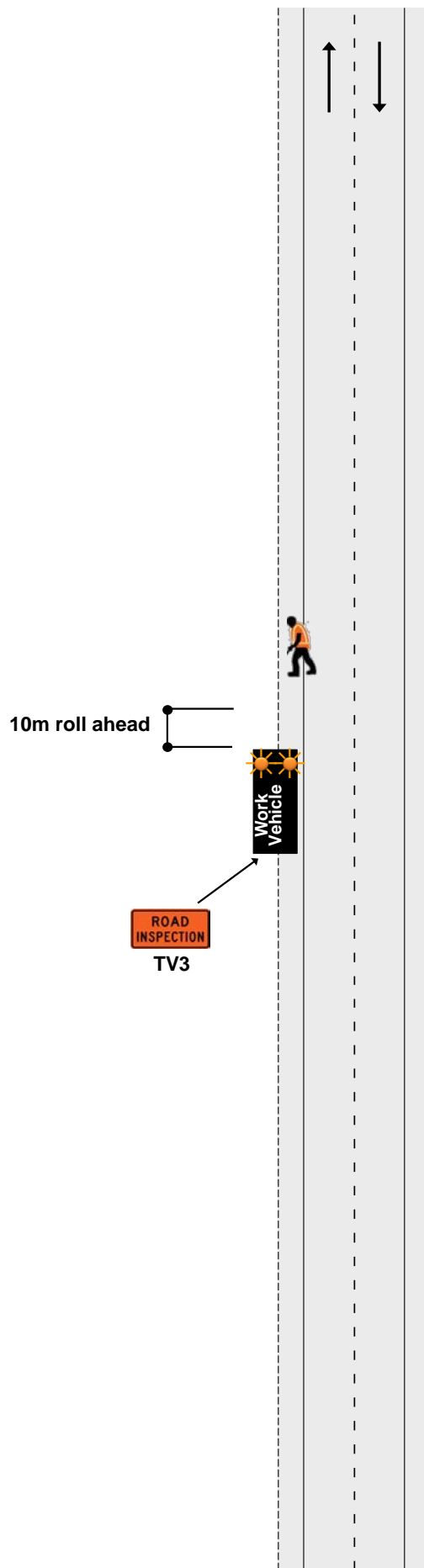

TWO-WAY TWO-LANE ROAD

Work vehicle is in a lane

With CSD - on LV Low-risk roads (any speed) and LV roads under 65km/h

F3.2

Level LV

Notes

1. This TMD can be used if the work vehicle is on shoulder, berm or live lane
2. The only signage required is a T1A sign with appropriate supplementary plate mounted on the rear of the work vehicle

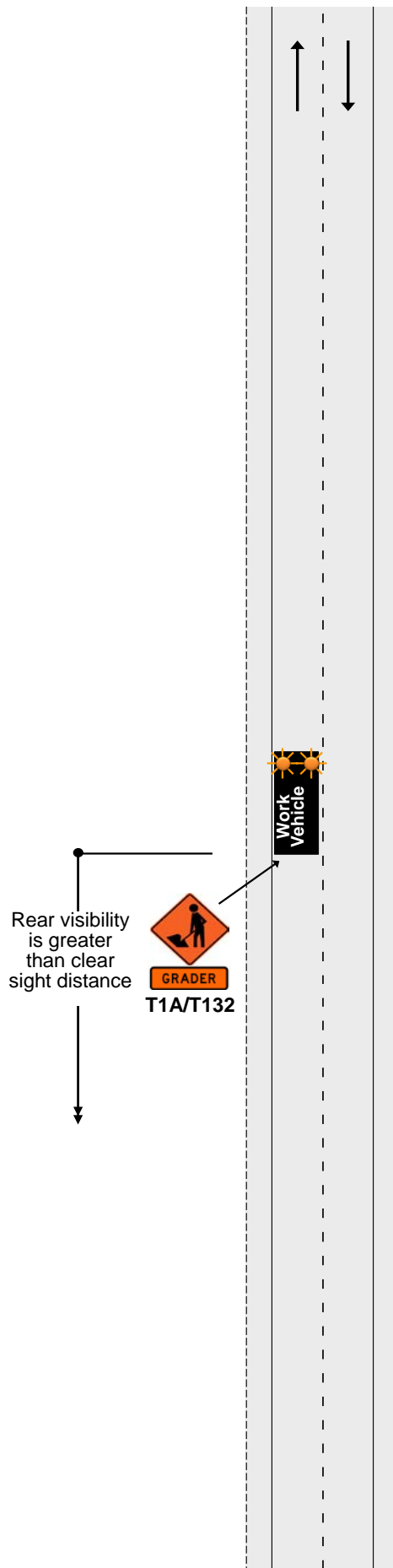

TWO-WAY TWO-LANE ROAD

Work vehicle is on berm, shoulder or lane

No CSD

F3.3

Level LV

Notes

1. This TMD can be used if the work vehicle is berm, shoulder or live lane
2. For long worksites, the T1A advance warning sign must be repeated throughout the worksite at intervals not greater than 4km
3. A tail pilot vehicle equipped with T1A advance warning sign and a supplementary plate (T132, T133, T136, T137) can be used to replace all static signs

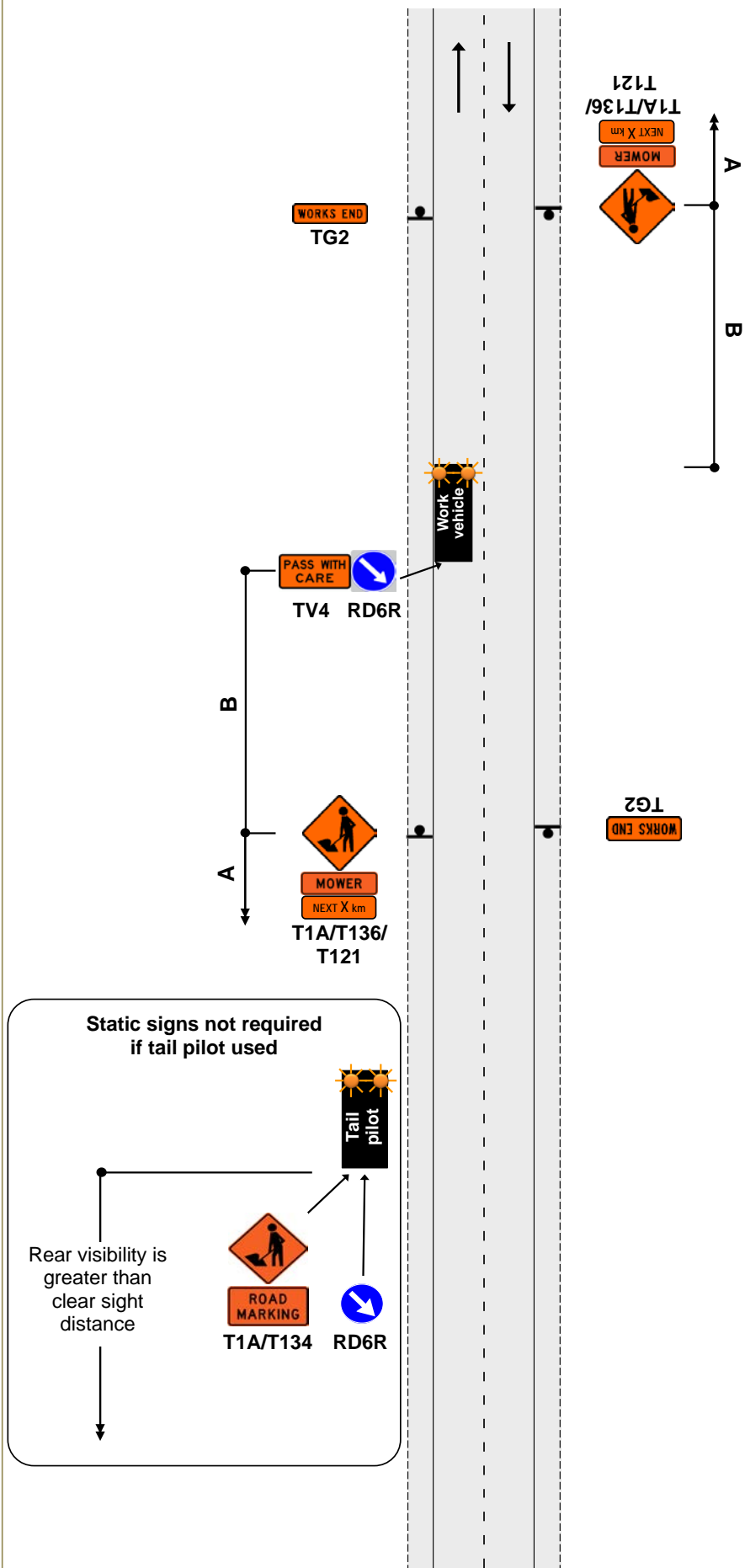

TWO-WAY TWO-LANE ROAD

Work vehicle on shoulder or berm - clear of live lane

CSD not required

F3.4

Level LV

Notes

1. The only signage required is a T1A sign with appropriate supplementary plate mounted on the rear of the work vehicle

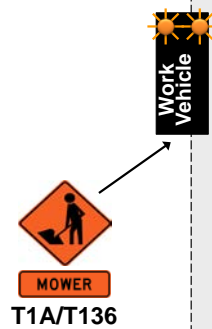

TWO-WAY TWO-LANE ROAD

Work vehicle is more than five (5) metres from the edgeline
Any speed

F4.1

Level 1

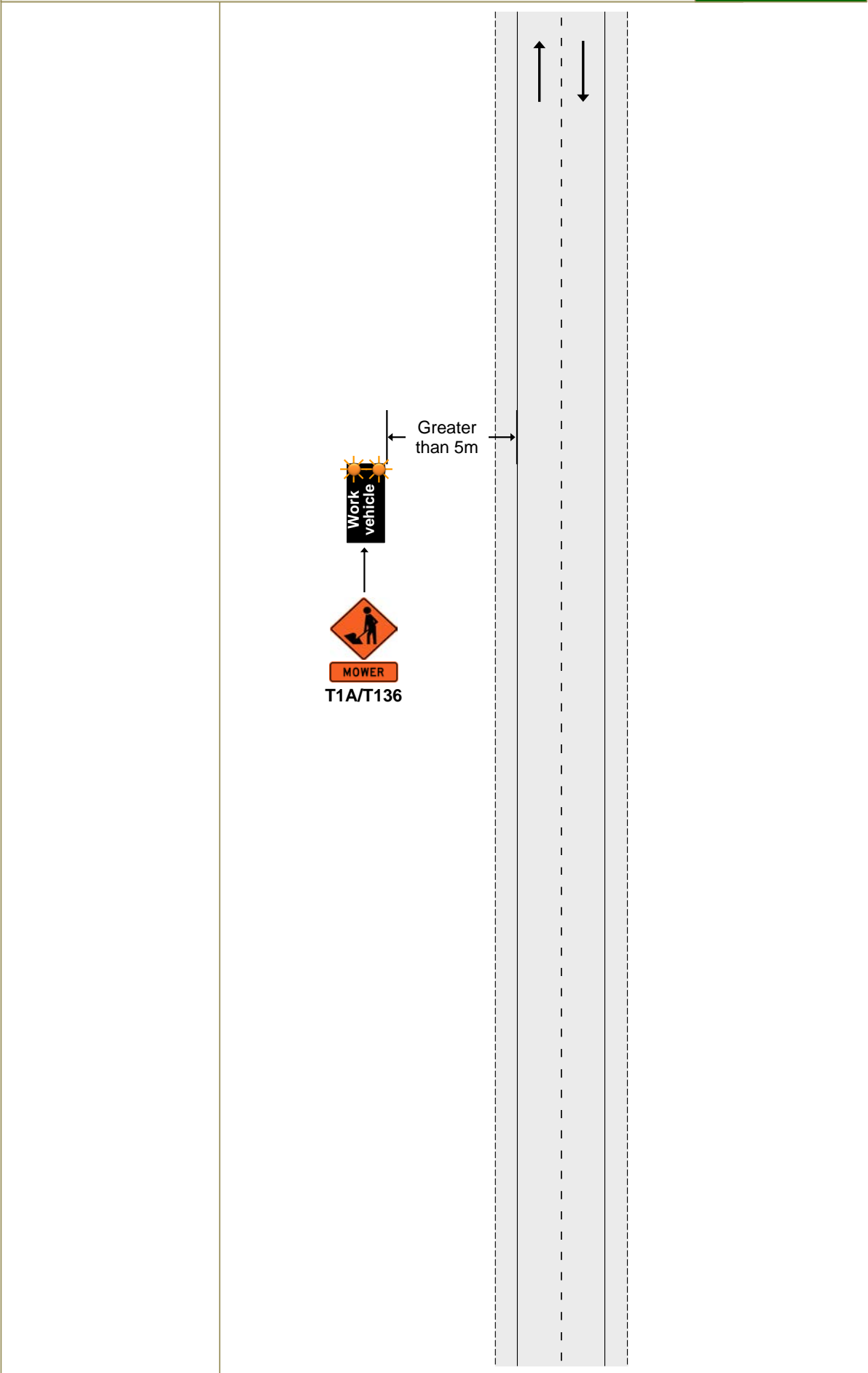

TWO-WAY TWO-LANE ROAD

Work vehicle is within five (5) metres of the edgeline

CSD to work vehicle - not required under 65km/h, required over 65km/h

F4.2

Level 1

Notes

1. If permanent speed is **under** 65km/h, rear visibility to the work vehicle is **not** required
2. If permanent speed is **over** 65km/h, rear visibility to the work vehicle is required
3. A tail pilot vehicle equipped with T1A advance warning sign, appropriate supplementary plate and RD6R may replace the static signs if the permanent speed is under 65km/h (see TMD F4.3)

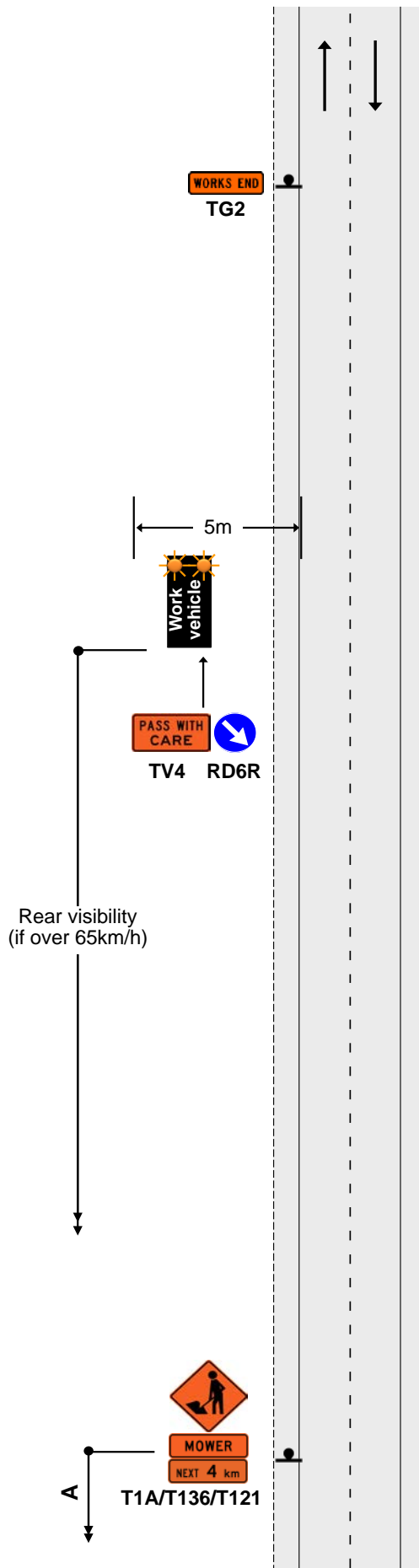

TWO-WAY TWO-LANE ROAD

Work vehicle is within five (5) metres of the edgeline
 Speed limit over 65km/h - the rear visibility is less than CSD

F4.3

Level 1

Notes

1. This TMD can replace TMD F4.2 when permanent speed is under 65km/h. In these situations, static signs are not required

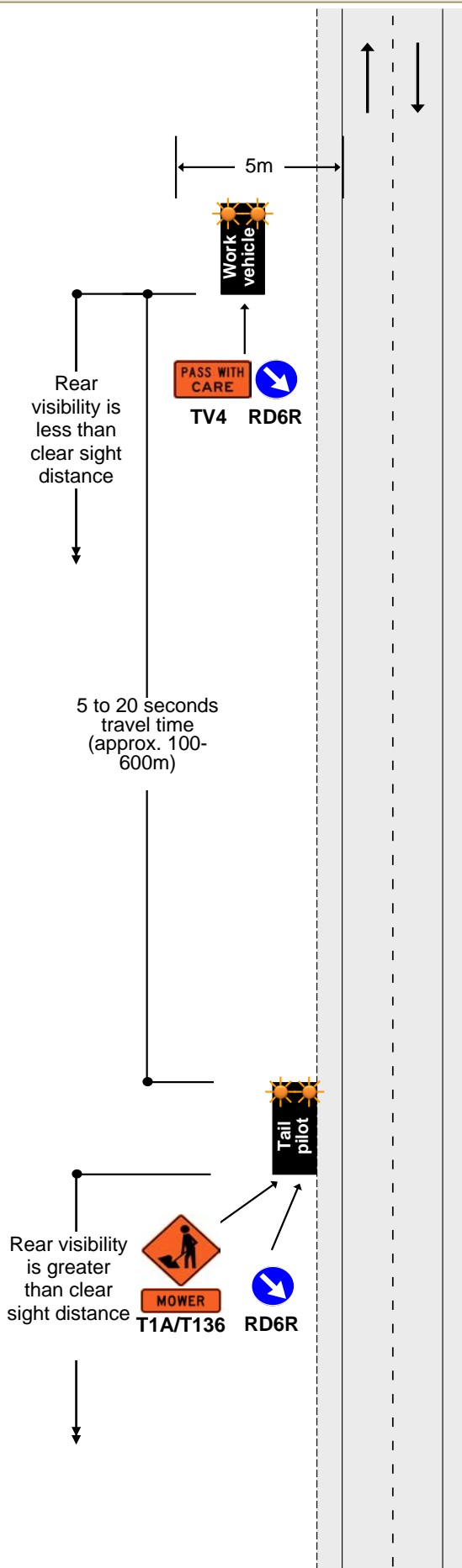

TWO-WAY TWO-LANE ROAD

Work vehicle is in a lane
Permanent speed under 65km/h

F4.4
Level 1

Notes

1. Advance warning sign X may be replaced by tail pilot equipped with T1A advance warning sign and appropriate supplementary plate
2. In this case, signs marked with Y do not need to be erected

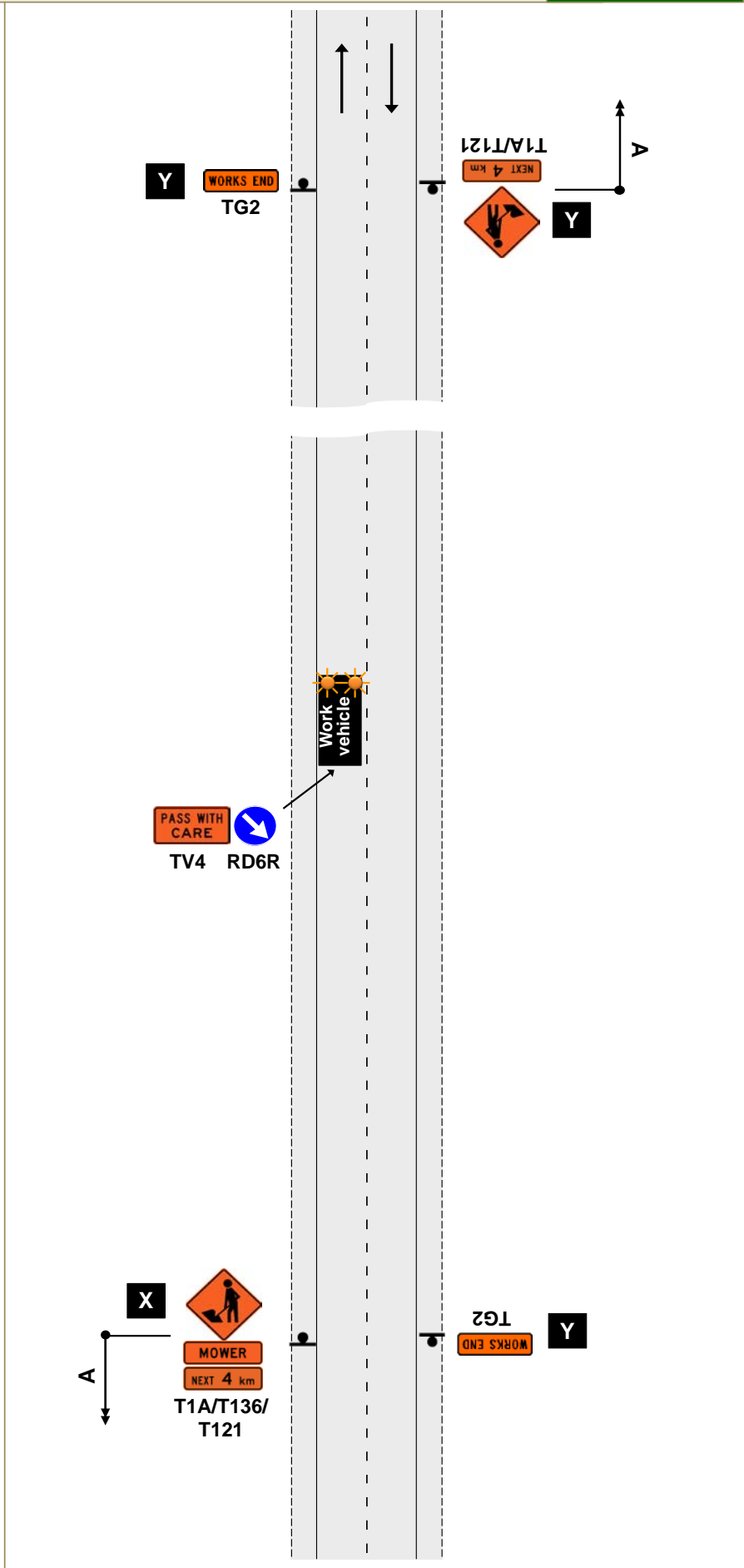

TWO-WAY TWO-LANE ROAD

Work vehicle is in a lane

Permanent speed over 65km/h - CSD forward visibility to work vehicle

F4.5

Level 1

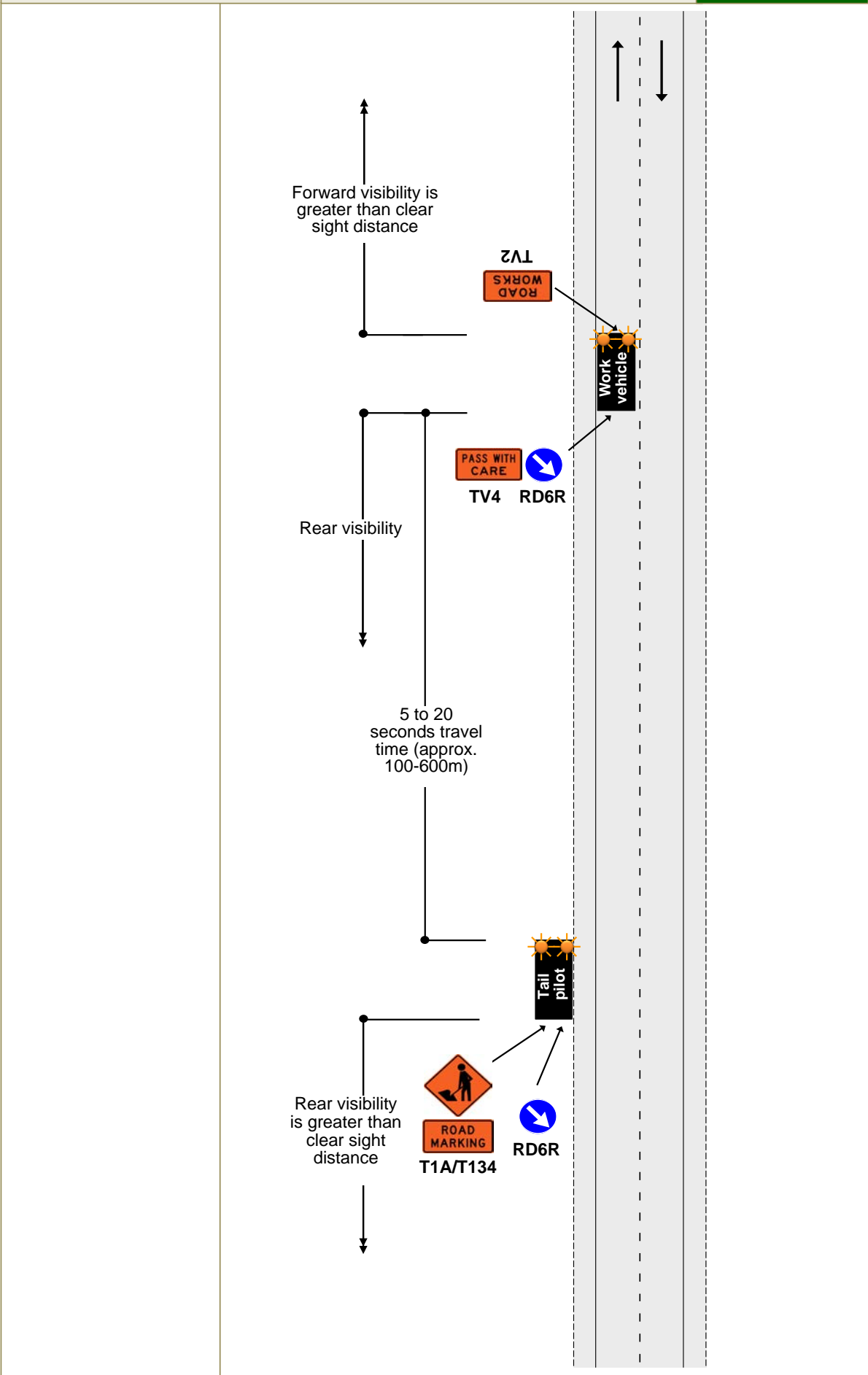

TWO-WAY TWO-LANE ROAD

Work vehicle is in a lane

Permanent speed over 65km/h - no CSD to work vehicle

F4.6

Level 1

Notes

- Both forward and rear visibility is less than the clear sight distance continuously for 1km to the work vehicle

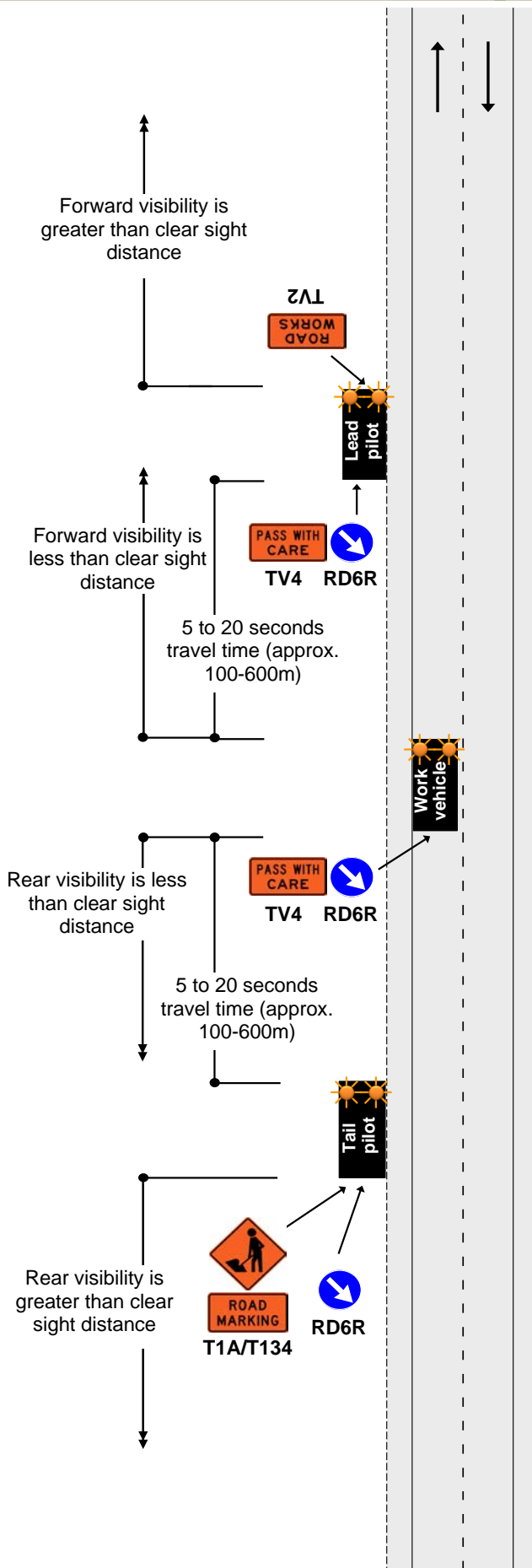

TWO-WAY TWO-LANE ROAD

Personnel on the road

Any speed

F4.7

Level 1

Notes

1. If the permanent speed is under 65km/h, the tail pilot vehicle may be replaced with static signs (T1A with appropriate supplementary plate and TG2)

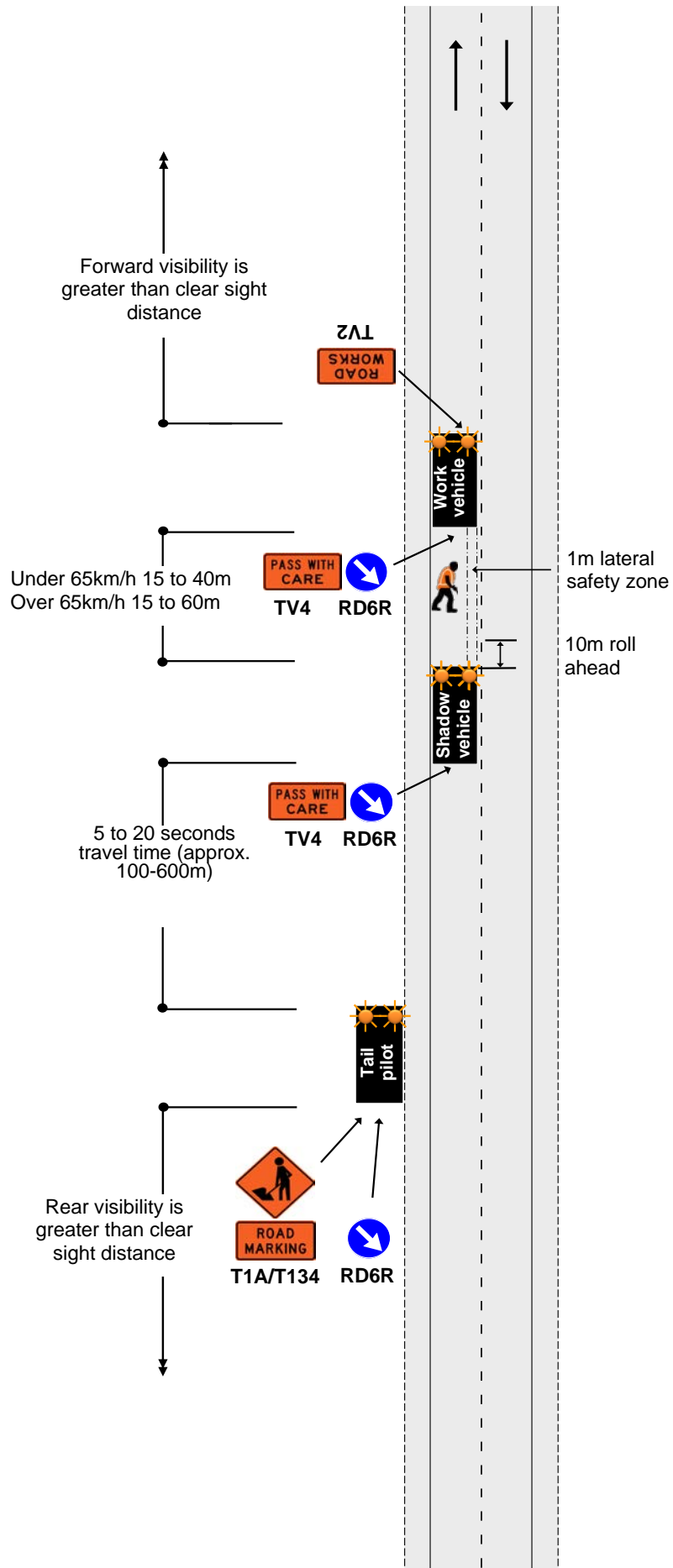

ONE-WAY TWO-LANE DIVIDED OR TWO-LANE ROAD

Work vehicle in the right lane
Permanent speed over 65km/h

F4.8

Level 1

Notes

1. If the permanent speed is under 65km/h, the tail pilot vehicle may be replaced with static signs (T1A with appropriate supplementary plate and TG2) on both sides of the carriageway

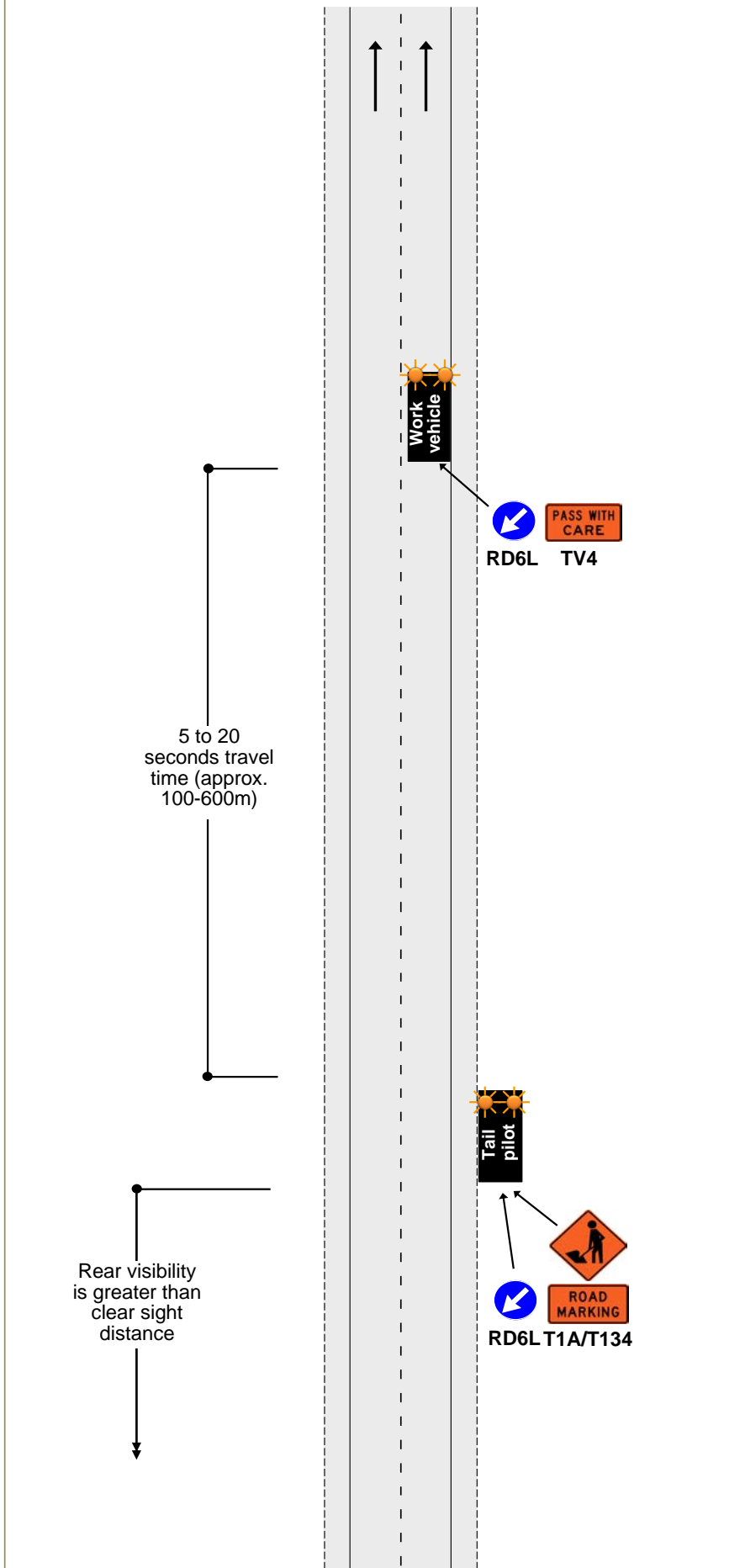

ONE-WAY TWO-LANE DIVIDED OR TWO-LANE ROAD

Personnel on the road

Any speed

J4.8a

Level 1

Notes

1. If the permanent speed is under 65km/h, the tail pilot vehicle may be replaced with static signs (T1A with appropriate supplementary plate and TG2)

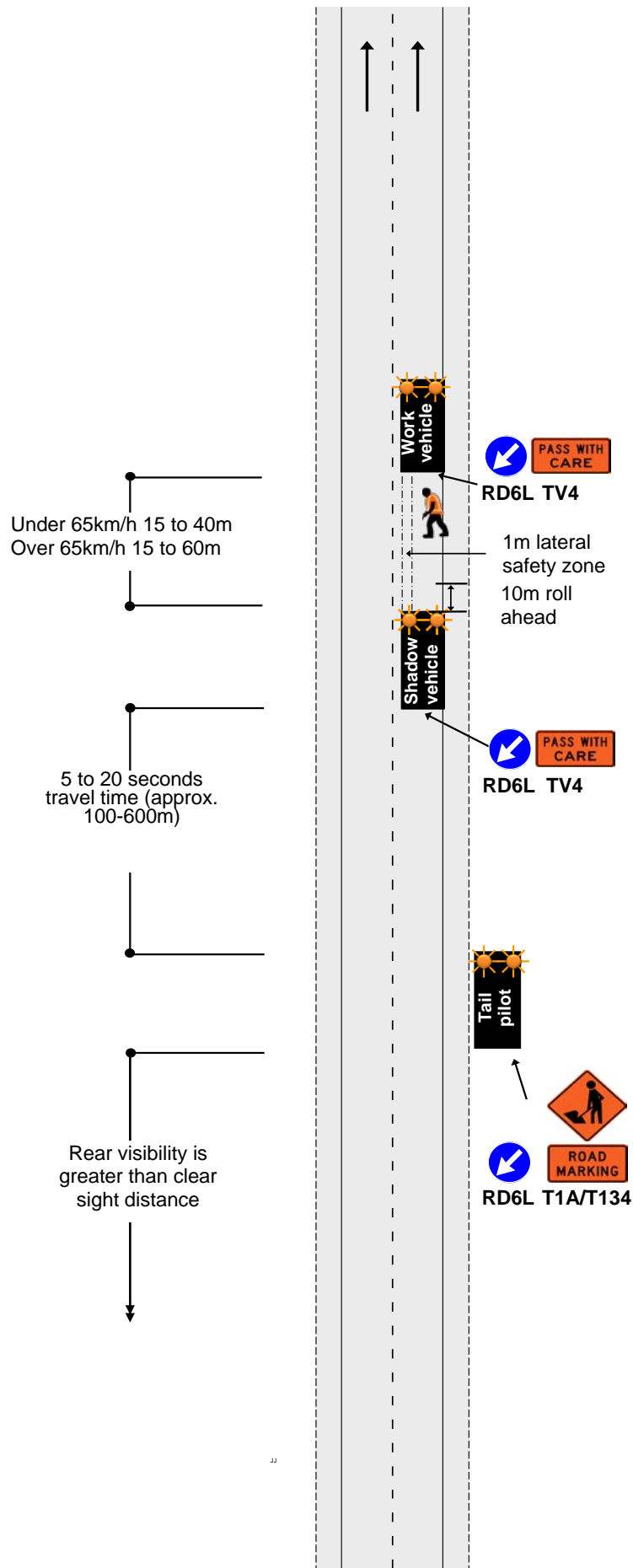

ONE-WAY TWO-LANE DIVIDED OR TWO-LANE ROAD

Part or all of a lane occupied
Semi-static closure - work for up to 1 hour

F4.9

Level 1

Notes

1. Only use this TMD when activity can be completed within 1 hour (excluding set up and removal of worksite)
2. The T1A advance warning signs may be replaced by a tail pilot vehicle with a T1A sign, appropriate supplementary plate and a RD6R/L
3. If shadow vehicle is fitted with a TMA, the longitudinal safety zone (D) is not required

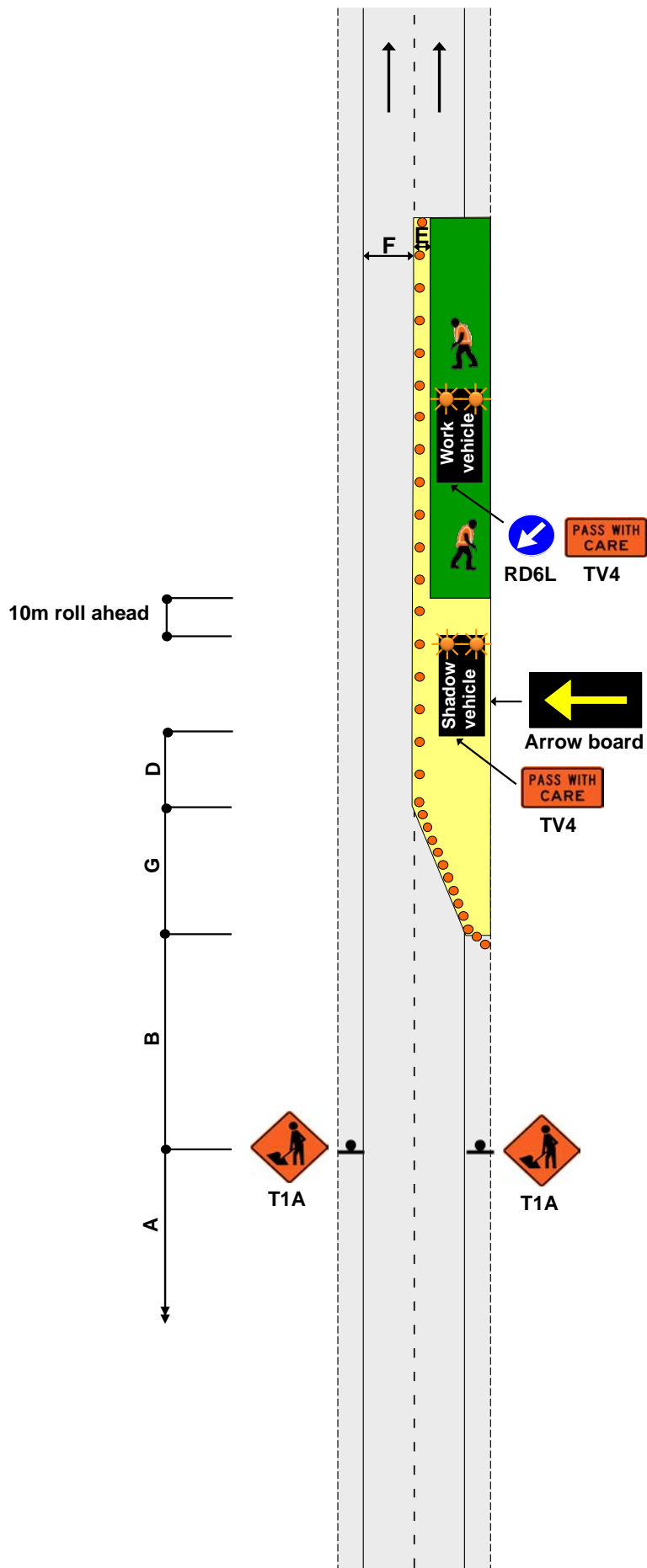

INSPECTION ACTIVITIES

On shoulder and on the live lane

J4.10

Level 1

Notes

1. Inspectors must move to avoid traffic. They must not expect traffic to move or slow down to avoid them
2. On busy roads where traffic volumes and speed affect access to the live lane, peak periods should be avoided or a higher level of TTM considered
3. Advance warning in the form of an inspection vehicle fitted with one and preferable two amber flashing beacons and a rear-mounted sign indicating the type of activity taking place must be positioned in advance of the inspection site
4. A vehicle is not required on a level LV or level 1 road with a permanent speed of less than 65km/h if the inspector remains on a footpath
5. On roads with a permanent speed of less than 65km/h an amber flashing beacon is not required on the vehicle if the inspector or non-invasive works is on an unsealed shoulder (or further away from the carriageway - including a footpath)
6. A spotter is not required for inspections and non-invasive works on level LV roads
7. Where no LV roads have been designated, the RCA can select level 1 roads for 'single inspector' inspections
8. Where an unaccompanied inspector is not able to maintain adequate attention (eg due to work tasks or poor visibility), a spotter person will be required or another type of traffic management operation used

Spotter required when inspector on the live lane of a level 1 road
(unless RCA has selected the road as suitable for 'single inspector' inspections)

S

I

No spotter required if inspector is working off the live lane

I



TV3











Note:

This page is to be used as the layout distances table for the level 1 static and semi-static diagrams.

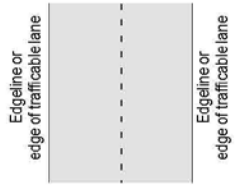
Print this page on A4 paper and fold it to fit an A5 page.

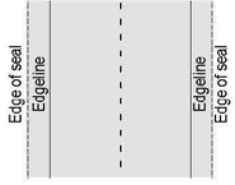
Unfold this page when you want to view the layout distances table and a diagram at the same time.

LEGEND FOR DIAGRAMS

<p>Working space</p> 	<p>Mandatory:</p> <ul style="list-style-type: none"> • Cones • Signs 
<p>Safety zones</p> 	<p>Optional:</p> <ul style="list-style-type: none"> • Cones • Signs 
<p>Edgeline or edge of trafficable lane (indicated by solid black line)</p> 	<p>Hazard area</p>  <p>Manhole</p> 
<p>Edge of seal (indicated by dotted line next to solid black line)</p> 	<p>Barrier, safety fence or cone bars</p>  <p>Ramp</p> 
<p>If the STMS has been delegated self-approval of TMPs by the RCA, this TMD must be referred to the TMC for approval</p> 	

COMBINED LEVEL LV & LEVEL 1 LAYOUT DISTANCES TABLE

Permanent speed limit or RCA-designated operating speed (km/h)	≤50	60	70	80	90	100		
Traffic signs								
A Sign visibility distance (m)	50	60	70	80	90	100		
B Warning distance (m)	50 or 30*	80	105	120	135	150		
C Sign spacing (m)	25 or 15*	40	50	60	70	75		
Safety zones								
D Longitudinal (m)*	10 or 5*	15	30	45	55	60		
E Lateral (m)*	1	1	1	1	1	1		
Tapers								
G Taper length (m)#	30	50	70	80	90	100		
G LV roads taper length (m)#	25	30	35	40	45	50		
K Distance between tapers (m)	40	50	70	80	90	100		
Delineation devices								
Cone spacing in taper (m)	2.5	2.5	5	5	5	5		
Cone spacing: Working space (m)##	5	5	10	10	10	10		
* Larger minimum distances apply on all state highways and also on all multi-lane roads. The smaller minimum distances may be applied on other roads to accommodate road environment constraints.								
+ On LV roads the longitudinal and lateral safety zones may be reduced, or eliminated, in order to retain a single lane width. Positive traffic management and an appropriate TSL must be used.								
# On non-state highways with speeds 50km/h or less, a 10m taper (with cones at 1m centres) may be used when there are road environment constraints (eg intersections and commercial accesses). On all roads where shoulder width is less than 2.5m and the activity does not affect the live lane, a 10m shoulder taper is permitted (with at least 5 cones at no greater than 2.5m centres). A taper of 30m (with cones at 2.5m centres) must be used where manual traffic control (stop/go), portable traffic signals or priority give way are employed.								
## LV roads: double the cone spacing alongside working space (eg 5 = 10, 10 = 20).								
Lane widths								
Speed (km/h)	30	40	50	60	70	80	90	100
F Lane width (m)	2.75	2.75	3.0	3.0	3.25	3.25	3.5	3.5

Except for delineation device spacings, which are maximum values, the distances specified in the above tables are minimum values.

LV/low risk roads

Working on roads designated as LV/low-risk roads (less than 250vpd - less than 20 vehicles per hour), with clear sight distance to the operation and an operating speed of less than 65km/h:

- use an appropriate advance warning sign (static installation) and amber flashing beacon(s) on working vehicle when on the shoulder
- consider stop/go or give way control of traffic when activity encroaches onto lane.

If the above requirements cannot be achieved, the operation must be modified to comply with the requirements of a higher risk rating.