



# NZ Transport Agency

## Advanced Bus Solution: Final Report

27 January 2017



L.E.K.

The materials contained in this document are intended to supplement a discussion with L.E.K. Consulting. These perspectives are confidential and will only be meaningful to those in attendance

## Context and Disclaimer – Terms of Access and Receipt

---

- L.E.K. Consulting (*L.E.K.*) wishes to draw the following important provisions to your attention prior to your receipt of or access to the L.E.K. report 'Advanced Bus Solution: Final Report, 27 January 2017' (*the L.E.K. Report*) including any accompanying presentation and commentary (*the L.E.K. Commentary*).
- The L.E.K. Report and any L.E.K. Commentary have been prepared for the New Zealand Transport Agency (*the Client*) in accordance with a specified scope of work described in the letter of engagement with the Client (*the Engagement Letter*). L.E.K. may provide upon request a copy of the Engagement Letter;
- Any person or entity (including without limitation the Client) which accepts receipt of or access to the L.E.K. Report and any L.E.K. Commentary (*the Recipient*) agrees to be bound by the terms and conditions set out below;
- In receiving or accessing any part of the L.E.K. Report and any L.E.K. Commentary, the Recipient acknowledges that:
  - L.E.K. has not been asked to independently verify or audit the information or material provided to it by or on behalf of the Client or any of the parties involved in the project;
  - the information contained in the L.E.K. Report and any L.E.K. Commentary has been compiled from information and material supplied by the Client and other third party sources and publicly available information which may (in part) be inaccurate or incomplete;
  - L.E.K. makes no representation, warranty or guarantee, whether express or implied, as to the quality, accuracy, reliability, currency or completeness of the information provided in the L.E.K. Report and any L.E.K. Commentary or that reasonable care has been taken in compiling or preparing them;
  - no part of the L.E.K. Report or L.E.K. Commentary may be circulated, quoted or reproduced for distribution outside the Client's organisation without the prior written approval of a Partner of L.E.K.;
  - the analysis contained in the L.E.K. Report and any L.E.K. Commentary are subject to the key assumptions, further qualifications and limitations included in the Engagement Letter and the L.E.K. Report and L.E.K. Commentary, and are subject to significant uncertainties and contingencies, some of which, if not all, are outside the control of L.E.K.; and
  - any L.E.K. Commentary accompanying the L.E.K. Report is an integral part of interpreting the L.E.K. Report. Consideration of the L.E.K. Report will be incomplete if it is reviewed in the absence of the L.E.K. Commentary and L.E.K. conclusions may be misinterpreted if the L.E.K. Report is reviewed in absence of the L.E.K. Commentary. The Recipient releases L.E.K. from any claims or liabilities arising from such an incomplete review;
- L.E.K. is not responsible or liable in any way for any loss or damage incurred by any person or entity relying on the information in, and the Recipient unconditionally and irrevocably releases L.E.K. from liability for loss or damage of any kind whatsoever arising from, the L.E.K. Report or L.E.K. Commentary including without limitation judgements, opinions, hypotheses, views, forecasts or any other outputs therein and any interpretation, opinion or conclusion that the Recipient may form as a result of examining the L.E.K. Report or L.E.K. Commentary. The L.E.K. Report and any L.E.K. Commentary may not be relied upon by the Recipient, and any use of, or reliance on that material is entirely at their own risk. L.E.K. shall have no liability for any loss or damage arising out of any such use.
- The L.E.K. Report and L.E.K. Commentary are strictly confidential and for the sole benefit of the Client. No person other than the Client (and the employees, partners, and officers of, and professional advisers to, the Client) or a Recipient (who has agreed to be bound the terms herein) may access the L.E.K. Report or L.E.K. Commentary or any part thereof. The Recipient undertakes to keep the L.E.K. Report and L.E.K. Commentary confidential and shall not disclose either the L.E.K. Report or L.E.K. Commentary or any part thereof to any other person without the prior written permission of a Partner of L.E.K.

## Project scope

---

- The objective of the 'Advanced Bus Solution' (ABS) study was to provide the details of a preferred advanced bus solution for central access and city to / from the Airport that provides the opportunity for a step change in current service levels
  - the Advanced Bus Solution utilises new and emerging technologies
  - it has been outlined to sufficient detail to enable comparisons with other modes at the Programme Business Case / Indicative Business Case level
- The study comprised six modules of work over an 11-week period (October – December 2016):
  - 1 Review of evaluation criteria and establishment of cost benefit analysis methodology
  - 2 Review of current bus solution
  - 3 Assessment of advanced bus initiatives
  - 4 Advanced bus option development
  - 5 Advanced bus option selection (based on cost-benefit and multi-criteria analysis)
  - 6 Definition of preferred 'Advanced Bus Solution(s)'
- The project was undertaken by L.E.K. Consulting, with support from TDG and international subject matter experts (James Tinnion-Morgan, Brendan Finn and Samuel Zimmerman)

## Project interpretation and limitations

---

- It is important to recognise the following five points in interpreting the Working Papers and Reports prepared by L.E.K. Consulting:
  - the study scope was strictly limited to defining a preferred 'Advanced Bus Solution' for future consideration against other rapid transit solutions
  - as such, the study does not address the merits of the ABS options against a 'do minimum' scenario nor against any other rapid transit solution, and no attempt should be made to leverage the study outputs for this purpose
  - however, in accordance with the requirements set out in the Project Brief, many of the ABS study outputs will be able to be leveraged in further consideration of the Central Access Plan (CAP) and South-western Multi-modal Airport Rapid Transit (SMART) business cases
  - where appropriate, and again in accordance with the Project Brief, the study has identified areas where further work will be required to permit a 'like-for-like' comparison of ABS with other rapid transit solutions as part of future CAP and SMART deliberations
  - in this context, some of these issues are tied (for example) to the need for additional ABS demand and capacity modelling, while others reflect the identification of entirely new strategic options identified as part of this study to address issues such as CBD bus movements and layover facilities

## Agenda

---

	<i>Page ref.</i>
● <b>Executive summary</b>	<b>4</b>
● Evaluation framework for the ABS study	15
● Review of current bus solution	26
● Summary of priority initiatives	48
● Outline of ABS options assessed	72
● Assessment of ABS options	197
● Next steps	210

# The Advanced Bus Solution (ABS) study comprised six modules completed over an 11 week period between October and December 2016

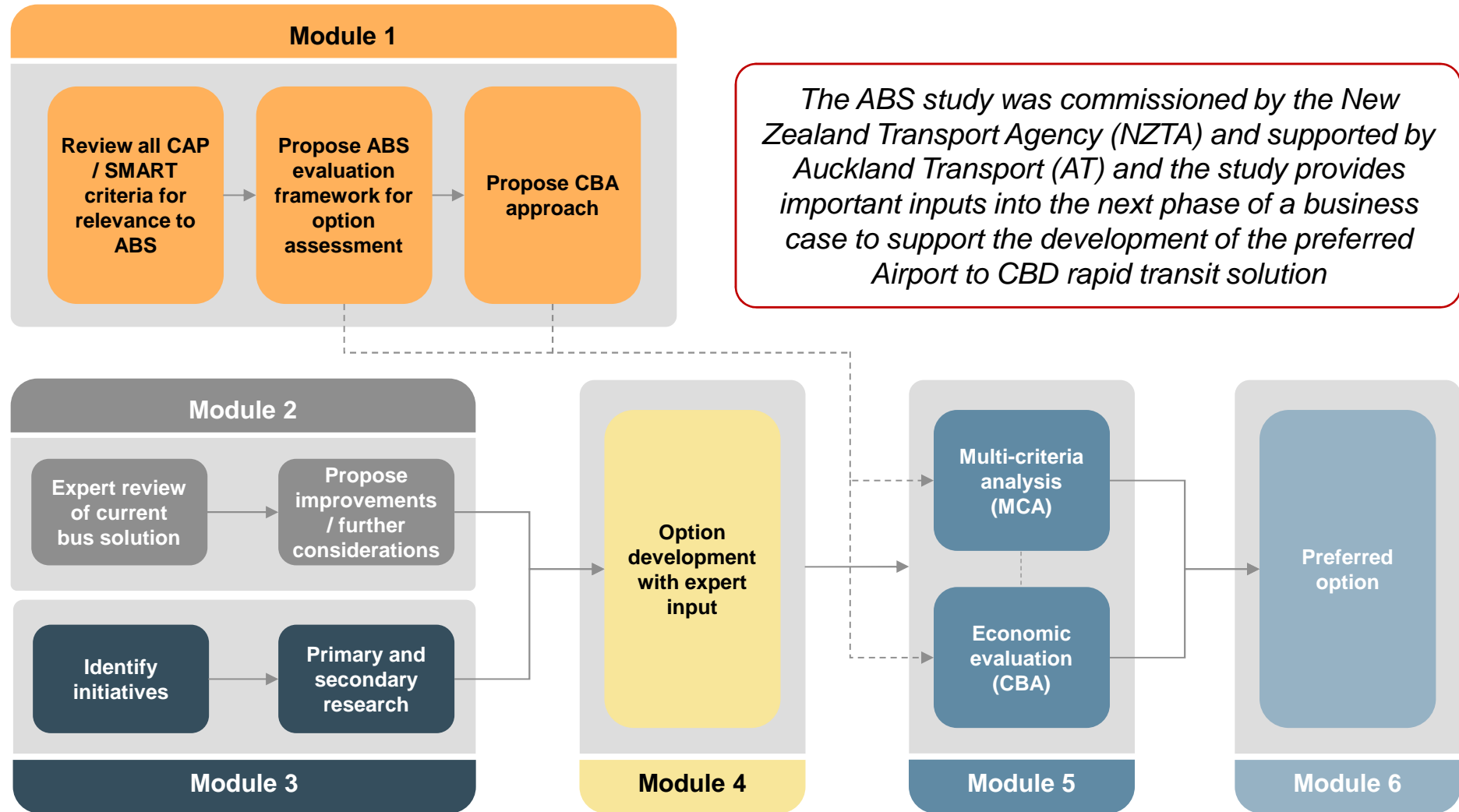

## Two ABS options were developed leveraging 14 key design principles developed by the L.E.K. team and our global rapid transit experts

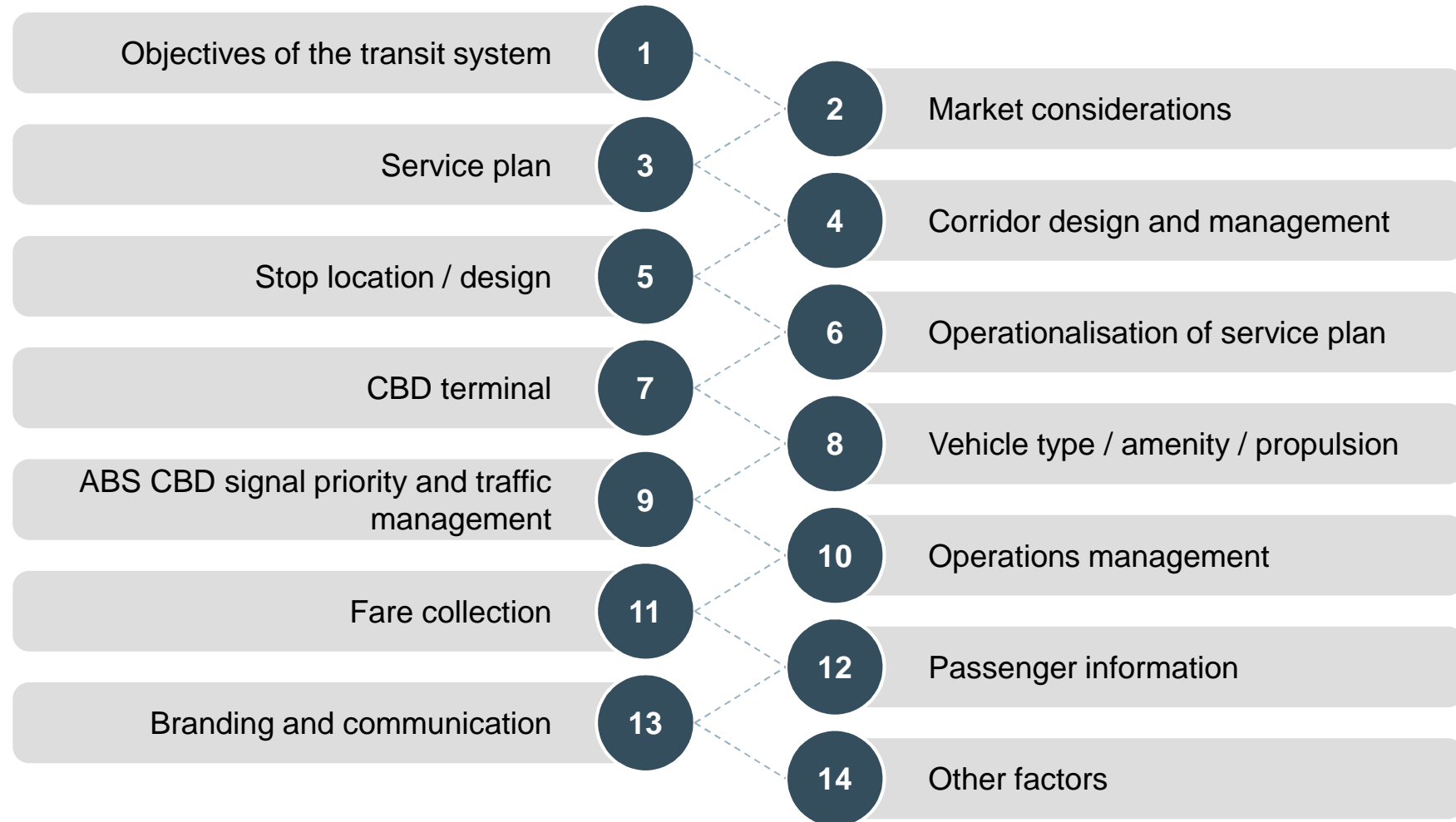

# The base case provides for the establishment of an advanced bus solution between the CBD and Airport utilising Dominion Rd (AART)

## Auckland CBD – Airport Rapid Transit (AART)

- The 'Auckland CBD – Airport Rapid Transit' (AART) option comprises three different types of service along the Dominion Rd corridor:
  - an 'all stops' service every four minutes (15 services per hour) from Mt Roskill Junction to Mt Roskill Junction via Britomart
  - an 'all stops' service every four minutes from the Airport to Airport via Britomart
  - two 'express' services every four minutes from the Airport to Airport via Britomart, only stopping at the express ABS stations
- Seven express ABS stations have been chosen, i.e. Britomart, Aotea Square, Karangahape Rd, Mt Roskill Junction, Onehunga Rail Station, Airport Business District and the Airport
- Key characteristics of the AART option include:
  - a public transport mall on Queen St from Customs St to Mayoral Dr
  - the use of median and parallel offset median stations along Dominion Rd (located at major traffic signal controlled intersections that allow for pedestrian access)
  - the use of median dedicated rights of way
  - the use of 18m articulated, specialised ABS vehicles (100 persons per vehicle; 60 seated and 40 standing) for 'all stops' services and double-decker ABS vehicles (100 persons per vehicle; 85 seated and 15 standing) for 'express' services
  - the use of hybrid vehicles at a minimum, with a gradual transition to all electric vehicles
  - off-board ticketing

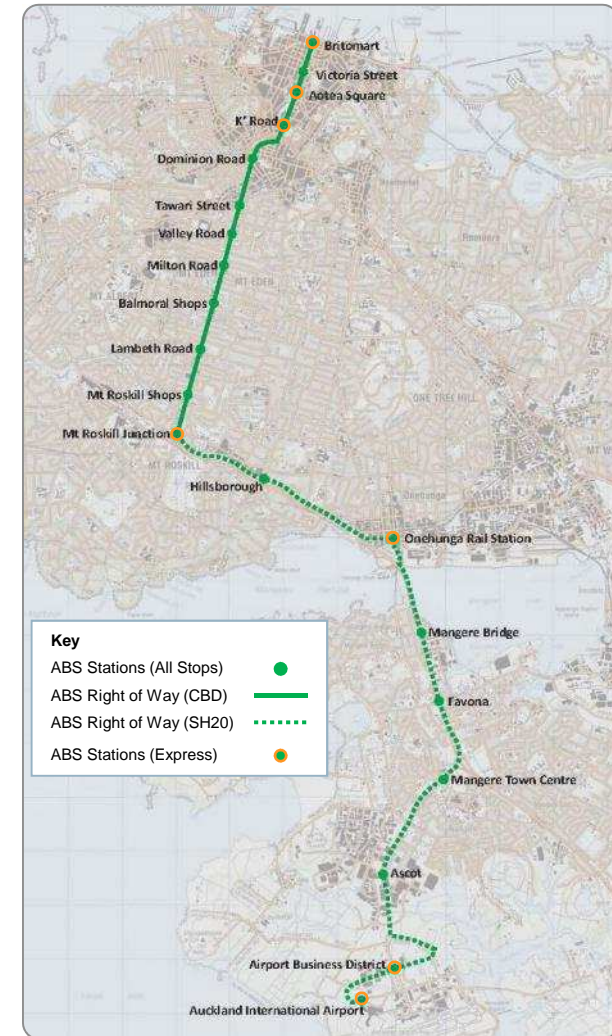



# The base case was assessed against an option leveraging both Dominion Rd and Manukau Rd (AART+)

## Auckland CBD – Airport Rapid Transit Plus (AART+)

- The 'Auckland CBD – Airport Rapid Transit Plus' (AART+) option comprises five different services along the Dominion Rd and Manukau Rd corridors:
  - an 'all stops' service every four minutes (15 services per hour) from Mt Roskill Junction to Mt Roskill Junction via Britomart along Dominion Rd
  - an 'all stops' service every four minutes from the Airport to Airport via Britomart along Dominion Rd
  - an 'all stops' service every eight minutes (7.5 services per hour) from the Airport to Airport via Britomart along Manukau Rd
  - an 'express' service every four minutes from the Airport to Airport via Britomart along Dominion Rd, only stopping at the express ABS stations
  - an 'express' service every eight minutes from the Airport to Airport via Britomart along Manukau Rd, only stopping at the express ABS stations
- Eight express ABS stations have been chosen, i.e. Britomart, Aotea Square, Karangahape Rd, Mt Roskill Junction, Newmarket Rail Station, Onehunga Rail Station, Airport Business District and the Airport
- Key characteristics of the AART+ option include:
  - a public transport mall on Queen St from Customs St to Mayoral Dr
  - the use of kerbside and lateral offset median stations along Dominion Rd and Manukau Rd (located at major traffic signal controlled intersections that allow for pedestrian access)
  - the use of median dedicated right of way on Dominion Rd and kerbside ROW on Manukau Rd
  - the use of 18m articulated, specialised ABS vehicles (100 persons per vehicle; 60 seated and 40 standing) for 'all stops' services along Dominion Rd and double-decker ABS vehicles (100 persons per vehicle; 85 seated and 15 standing) for 'all stops' services along Manukau Rd and all 'express' services
  - the use of hybrid vehicles at a minimum, with a gradual transition to all electric vehicles
  - off-board ticketing

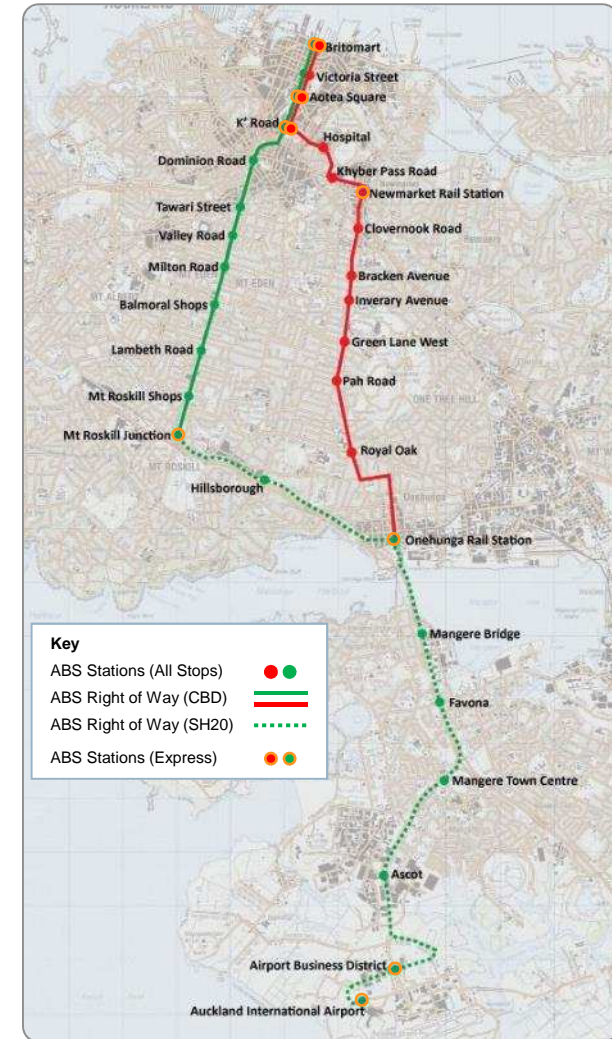

# The multi-criteria analysis (MCA) did not identify a clear preference for either AART or AART+

## Multi-criteria analysis of AART+ relative to AART, unweighted basis (summary)

Theme	Sub-theme (if applicable)	AART+ relative to AART	Commentary
1 Economic growth		Minor positive impact	AART+ serves a larger catchment than AART along two corridors (Dominion Rd and Manukau Rd) and provides additional capacity
2 Network efficiency, reliability and resilience	A To / from Airport and city centre	Minor positive impact	Both options provide similar benefits for travel between the Airport and city centre, with AART+ providing additional reliability benefits and increased patronage
	B In the Mangere-Otahuhu area	Minor positive impact	Both options provide a similar function in the Mangere-Otahuhu area, with AART+ providing additional connections to multiple corridors
	C In the city centre	Minor positive impact	AART+ operates along multiple corridors and so provides some additional benefits to AART in the city centre
	D New technology	No significant impact	There is no significant difference between the options in terms of new technology
3 Liveability and safety	A To / from Airport and city centre	No significant impact	There is no significant difference between the two options except that there is a higher potential for enhancements across multiple corridors
	B In the city centre	Minor negative impact	There is a minor difference between the two options in terms of liveability and safety in the city centre as AART+ has more vehicles operating along Queen St
4 Environmental sustainability		Minor positive impact	AART+ provides slightly higher noise and emissions benefits than AART
5 Implementability		Minor negative impact	AART+ is expected to be more difficult to implement than AART
6 Investment affordability		Minor negative impact	AART+ has a higher cost in net financial terms compared to AART

	AART+ relative to AART
Overall MCA assessment	No significant impact

*AART+ provides some additional benefits relative to AART because AART+ operates over two corridors, serving a larger catchment and providing additional capacity. However, AART+ will be more difficult and costly to implement and operate than AART*

*The MCA did not clearly distinguish between the two ABS options*

**All 75 evaluation criteria were assessed and details have been included in the Appendix**

Key: Major negative impact (orange), Minor negative impact (yellow), No significant impact (grey), Minor positive impact (light green), Major positive impact (dark green)

Source: L.E.K. analysis; Auckland Transport SMART Business Case; CAP programme business case

## The CBA evaluated 11 criteria in order to determine the incremental benefit delivered by AART+ over AART

### Economic evaluation for ABS: Basis of quantification

Key benefits that were assessed via the CBA		
1	<i>Travel time benefits</i>	Value of travel time savings to existing and new bus users due to improved average speed
2	<i>Traffic decongestion benefit</i>	Value of reduced level of road traffic congestion in the network
3	<i>Reliability benefits</i>	Value of reduced variability in bus journey times to existing and new bus users
4	<i>Noise benefits</i>	The value of public health benefits (sleep and speech disturbance, stress and psychological impacts) due to reduced ambient noise from buses (e.g. progressive introduction of electric buses)
5	<i>Emissions benefits</i>	Value of reduction in emissions based on a defined price for CO <sub>2</sub> , NO <sub>x</sub> and PM <sub>10</sub> from buses (e.g. progressive introduction of electric buses), and from passengers diverted from cars to public transport
6	<i>Walking benefits</i>	The health benefit new users gain from walking to bus stops
7	<i>User amenity benefits</i>	Value of the attributes of bus services and infrastructure to new and existing bus users
8	<i>Residual value benefit</i>	Remaining value of initial infrastructure investment at the end of the analysis period (net present value)
9	<i>Capital investment (CAPEX)</i>	Value of initial investment in order to achieve desired benefits
10	<i>Operating costs (OPEX)</i>	Value of operating costs in order to maintain desired benefits
11	<i>Induced demand (farebox revenue)</i>	Value of additional farebox revenue resulting from induced demand on buses

Source: NZTA Economic Evaluation Manual; L.E.K. analysis

# When compared with AART, AART+ is estimated to generate an incremental benefit of \$93m in net present value terms (2016 prices) and an incremental BCR of 1.61

## Incremental benefit of AART+ over AART, by type (NPV) (2016)

Millions of NZD

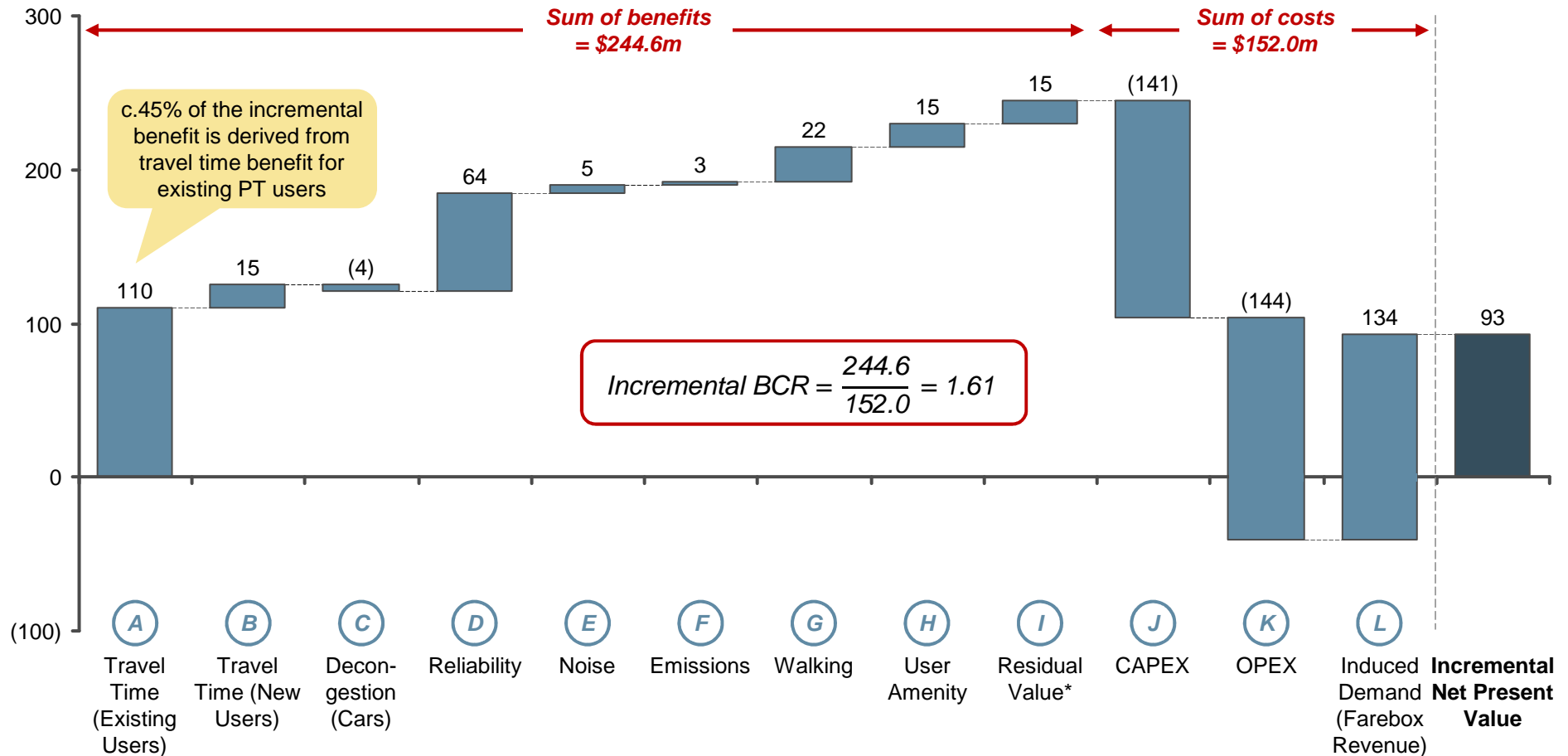

Note: \* The residual value is the net present value (in 2016) of the remaining value of the infrastructure capital expenditure in 2046. The value of the infrastructure in 2046 is calculated using straight-line depreciation over 40 years and is thus 50% of the original capital expenditure

Source: NZTA Economic Evaluation Manual; JMAC ART3 / APT3 model output; L.E.K. analysis

The sensitivity of the CBA was flexed across three metrics, indicating an incremental NPV range of \$37m – \$185m (2016 prices)

Metric	Assessment range	Incremental Net Present Value	Incremental BCR
<i>Discount rate</i>	4%	\$184.9m	2.07
	8%	\$37.4m	1.28
<i>Capital expenditure</i>	-25%	\$124.3m	2.07
	+25%	\$61.1m	1.33
<i>Operating expenditure</i>	-25%	\$128.8m	2.11
	+25%	\$56.6m	1.30

Source: NZTA Economic Evaluation Manual; JMAC ART3 / APT3 model output; L.E.K. analysis

# The MCA does not provide a strong rationale for one option over another while the CBA favours AART+ over AART

Option MCA

Option CBA

Theme	Sub-theme (if applicable)	AART+ relative to AART
Economic growth		Minor positive impact
Network efficiency, reliability and resilience	To / from Airport and city centre	No significant impact
	In the Mangere-Otahuhu area	Minor positive impact
	In the city centre	Minor positive impact
	New technology	No significant impact
Liveability and safety	To / from Airport and city centre	No significant impact
	In the city centre	Minor negative impact
Environmental sustainability		Minor positive impact
Implementability		Major negative impact
Investment affordability		Major negative impact
Overall assessment		No significant impact

*AART+ provides some additional benefits relative to AART because AART+ operates over two corridors, serving a larger catchment and providing additional capacity. However, AART+ will be more difficult and costly to implement and operate than AART. The MCA did not clearly distinguish between the two ABS options*

Incremental benefit of AART+ over AART, by type (NPV) (2016)

Millions of NZD

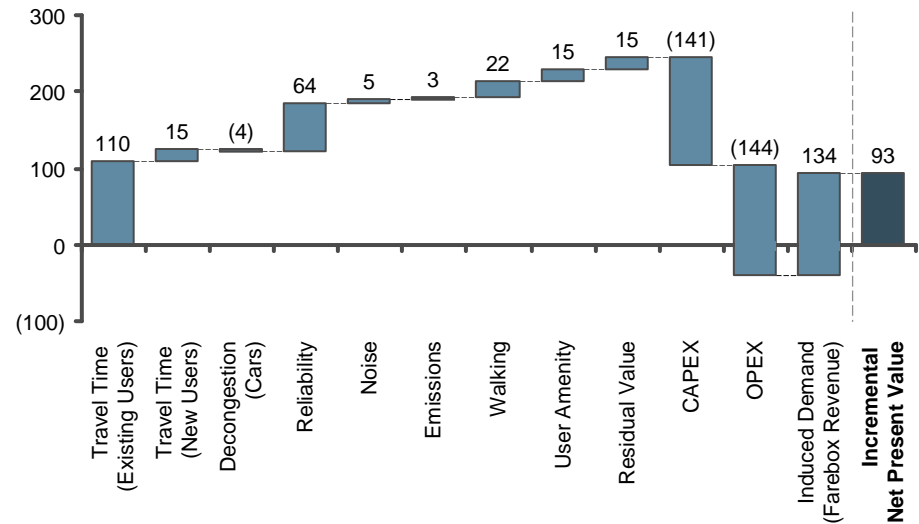

**Incremental Net Present Value: \$92.7m**

**Incremental BCR: 1.61**

*AART+ provides a greater catchment area, which is the primary driver for the travel time and induced demand benefits. This more than offsets the additional capital and operating costs associated with the delivery of AART+*

Key: Major negative impact (Orange), Minor negative impact (Yellow), No significant impact (Grey), Minor positive impact (Light Green), Major positive impact (Dark Green)

Source: NZTA Economic Evaluation Manual; JMAC ART3 / APT3 model output; L.E.K. analysis

## There are a number of additional steps that need to be taken to further develop AART and AART+ for the business case development process

<b><i>Integrated service planning</i></b>	<ul style="list-style-type: none"> <li>● Integration and optimisation required for the ABS network and the New Network solution, such that PT patronage can be maximised whilst meeting appropriate levels of customer amenity</li> </ul>
<b><i>Overtaking</i></b>	<ul style="list-style-type: none"> <li>● For both AART and AART+ the service plan proposals used for the base assessment have sought to utilise all stops and express services such that passing will be required; as such this report includes some additional visualisation of these options – however the use of a microsimulation or detailed animation package may be required to aid operational understanding in the future</li> </ul>
<b><i>CBD layover optimisation</i></b>	<ul style="list-style-type: none"> <li>● Identified strategies to minimise and/or optimise the CBD layovers through a range of initiatives (e.g. utilising airport layovers, CBD through running, virtual layovers, etc.) require further evaluation</li> <li>● Overnight storage of a number of buses are required for the 5am start time from Queen St and this would need to be associated with the ability to re-fuel and clean vehicles as necessary</li> </ul>
<b><i>Traffic management</i></b>	<ul style="list-style-type: none"> <li>● Further detailed analysis will be required to understand and develop appropriate mitigation strategies for both general traffic and bus traffic more specifically (e.g. intersection micro-simulation analysis), accounting for advanced ITS technologies</li> <li>● Integration of the proposals with the cycle network and provision for cycle parking at key interchanges where park and ride is proposed</li> </ul>
<b><i>Vehicle type / propulsion</i></b>	<ul style="list-style-type: none"> <li>● Timing for technology shifts in propulsion requires detailed analysis into the pro's and con's of the opening year choices versus the 2036 or 2046 requirements; e.g. full electric vehicles are heavier than hybrid electric due to larger batteries and this may mean axle loadings are exceeded with less passengers</li> <li>● Service planning may include removal of full electric in off peak times and operate in peak hours only</li> <li>● Larger scale buses are being developed to meet urban demand for BRT and exceed now 300 passengers, such proposals may provide significant rapid transit capacity without the need to increase frequencies or platoon buses</li> </ul>
<b><i>Route alignment and stop location</i></b>	<ul style="list-style-type: none"> <li>● Further analysis and review should be completed to “fine tune” the advanced bus solution (e.g. to optimise demand, minimise any adverse general traffic impacts – potentially confirmed via intersection micro-simulation modelling, etc.)</li> <li>● Consideration of the opportunity for grade separation of major east – west intersections and routes for reduced conflict with ABS buses</li> </ul>
<b><i>Demand modelling</i></b>	<ul style="list-style-type: none"> <li>● Further model runs are likely to be appropriate to optimise expected demand, having regard to the impact on the assessed economic merit via the CBA</li> </ul>
<b><i>CBA and MCA</i></b>	<ul style="list-style-type: none"> <li>● It is likely that many of the cost and benefit line items derived for the preferred advanced bus option will require further refinement before being “fit for purpose” for comparison against any alternative rapid transit proposal</li> </ul>

## Agenda

---

	<i>Page ref.</i>
● Executive summary	4
● <b>Evaluation framework for the ABS study</b>	<b>15</b>
● Review of current bus solution	26
● Summary of priority initiatives	48
● Outline of ABS options assessed	72
● Assessment of ABS options	197
● Next steps	210



## The ABS study involved an assessment of advanced bus initiatives, development of two potential options and selection of the preferred option

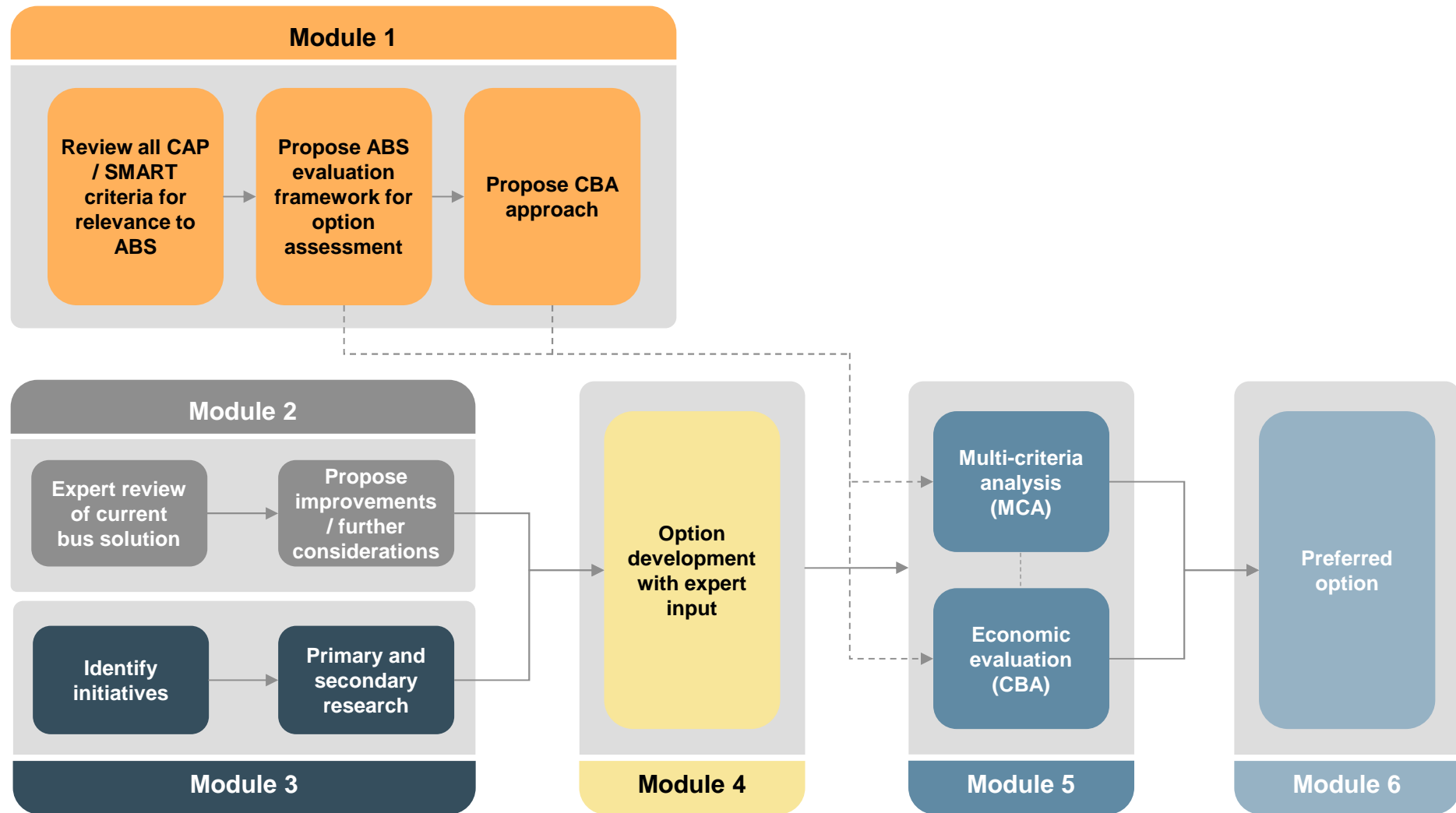

## This process required a framework for evaluating the developed options and performing a cost benefit analysis (CBA)

---

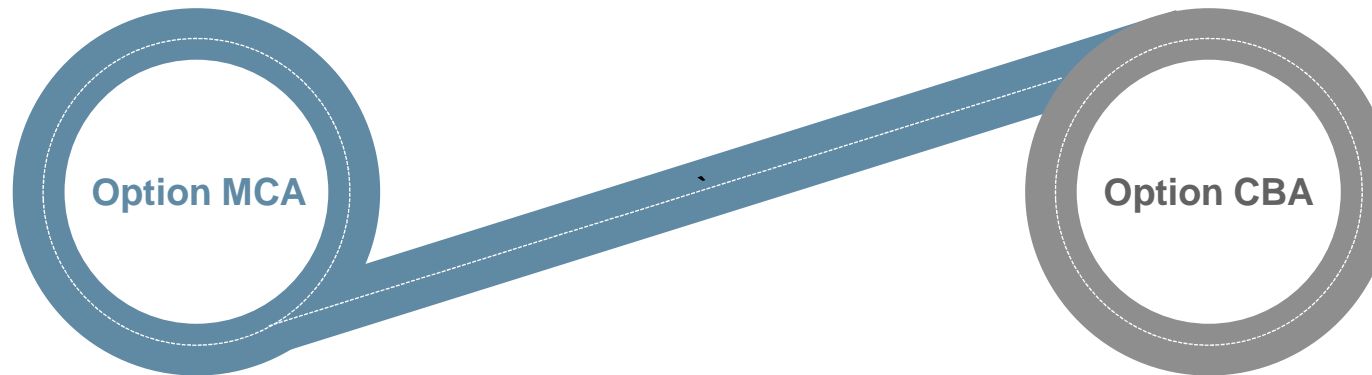

- The CAP and SMART studies have an extensive list of evaluation criteria (73 criteria), which are both quantitative and qualitative aspects
- A consolidated evaluation framework was created to ensure all criteria were assessed, as far as practicable, within the project timeframe
- This framework was used for the multi-criteria analysis (MCA) and to determine the ***relevant criteria for ABS*** that should be incorporated into the option CBA
- The MCA was carried out by comparing the two ABS options against one another (i.e. the option case relative to the base case) on an unweighted basis
- The key benefits assessed in the cost benefit analysis (CBA) are tied to the relevant ABS option evaluation criteria
- Most of the expected benefits and the methodology in which these benefits are assessed have been based on the *NZTA Economic Evaluation Manual (EEM)* as they are covered in the CAP and SMART studies
- Other parameters have been defined / estimated outside of the EEM for the purpose of the ABS study
- For the purposes of the CBA, the incremental benefits / costs of the option case were compared against the base case

# The 73 CAP / SMART evaluation criteria were consolidated and categorised into six key themes, two of which relate to SMART only

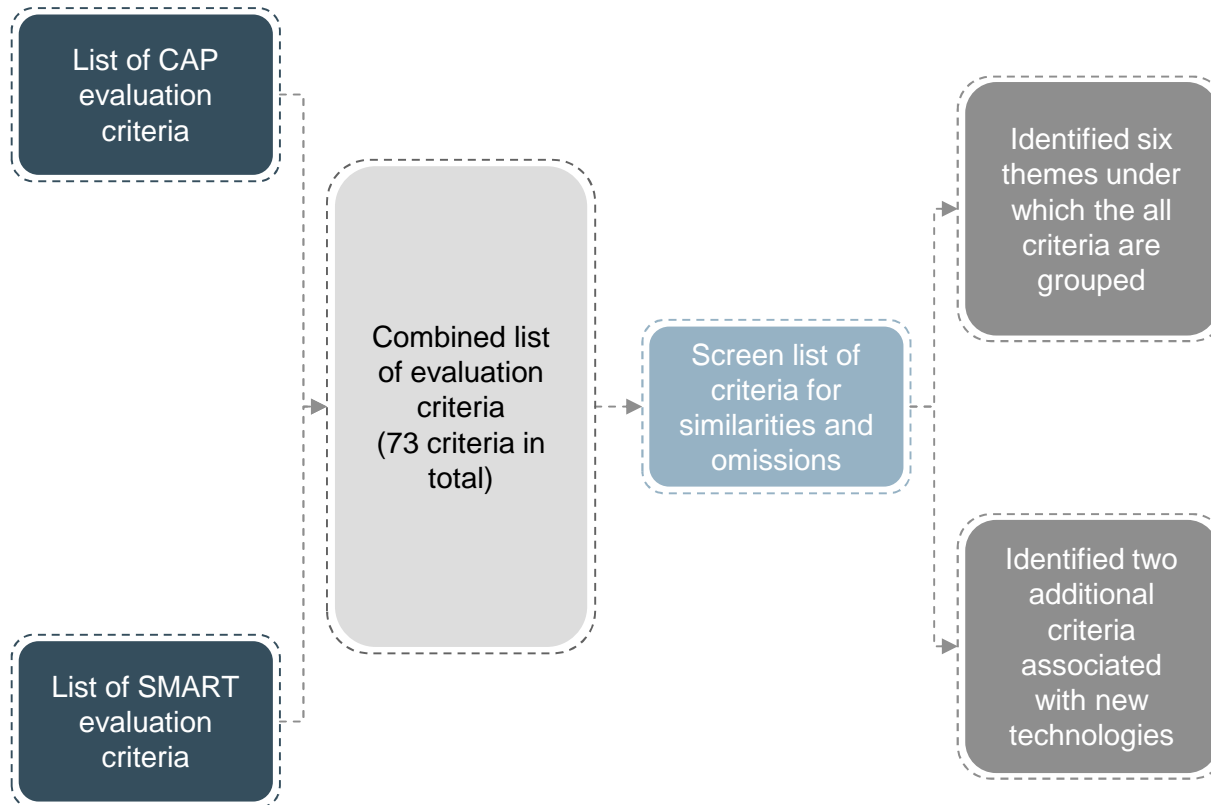
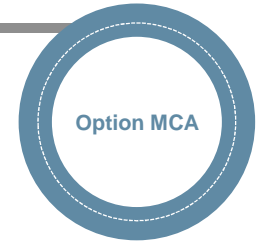

1	Economic growth	Applies to both CAP and SMART
2	Network efficiency, reliability and resilience	
3	Liveability and safety	
4	Environmental sustainability	
5	Implementability	Applies to SMART only
6	Investment affordability	





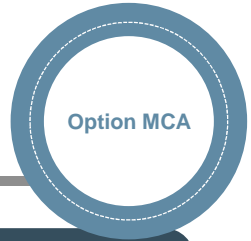

Categorised as 'new technology' under the theme 'network efficiency, reliability and resilience'

- i Customer decision making from Real Time Passenger Information (RTPI)
- ii Customer satisfaction from RTPI

Both arise as benefits of the advances in technology and are not addressed elsewhere in the evaluation framework

# The six key themes in the ABS evaluation framework address the key questions posed by both CAP and SMART in a holistic way



	Key themes	Questions that they are trying to address	CAP / SMART
1	 Economic growth	How does the proposed bus option contribute to prosperity and growth of Auckland city and the Auckland Airport region?	<i>Applies to both CAP and SMART</i>
2	 Network efficiency, reliability and resilience	How does the proposed bus option improve efficiency, reliability and resilience of the public transport network?	
3	 Liveability and safety	How does the proposed bus option contribute to an attractive, vibrant and safe city in which to live?	
4	 Environmental sustainability	Does the proposed bus option provide a sustainable solution that minimises environmental impacts?	
5	 Implementability	Is the proposed bus option credible at a business case level?	<i>Applies to SMART only</i>
6	 Investment affordability	Is the investment affordable and does it provide value for money over the life of the asset?	

# This framework was used for the MCA of the two ABS options developed against one another to ensure alignment with CAP / SMART (1 of 4)

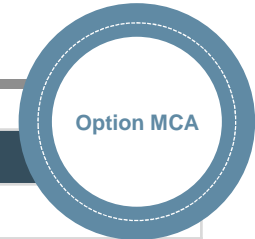

Theme	Sub-theme (if applicable)	SMART / CAP objective	Evaluation criteria	Metric / scale to be assessed
1 Economic growth		Significantly contribute to lifting and shaping Auckland's economic growth	Efficient access to existing and planned employment within the Airport and (surrounding) business district	Travel times between the Airport and city centre from model
			Efficient access to existing and planned employment from the wider Mangere area	Travel times between the Mangere area and the Airport / city from model
			Potential to increase development along the corridor	Qualitative assessment of employment catchments enabling development
		Auckland's prosperity and growth are enabled	Enabled employment growth and supported economic regeneration in the wider Mangere area	Qualitative assessment to employment catchments enabling economic growth
			Increased access to city centre (business to business)	Number of job places within 45 mins by public transport & walk / cycle & 30 mins by car to city centre at peak
			Increased access to city centre (labour pool – workers to business)	Number of residents within 45 mins by public transport & walk / cycle & 30 mins by car to city centre at peak
2 Network efficiency, reliability and resilience	A To / from Airport and city centre	Improve the efficiency and resilience of the transport network	Increased match between volume to capacity – city centre routes over time	Number of people per hour by major corridor at peak periods
			Increased public transport patronage to / from the Airport and (surrounding) business district	Airport to city public transport patronage from model
			Reduced congestion to/from the Airport and (surrounding) business district	Private vehicle km from model
			Improved public transport travel times on key routes to / from the Airport and (surrounding) business district	Public transport travel time in peak from model
			Enabled efficient public transport travel between the city centre and the Airport	Public transport travel time in peak from model and the impact on efficiency
			Improved freight travel times to / from the Airport and (surrounding) business district on the strategic freight network	Travel times on strategic freight routes from model
			Improved private vehicle travel times to / from the Airport and (surrounding) business district within the area of influence of the study	Travel times on key routes from model
			Improved public transport journey time reliability to the Airport and (surrounding) business district	Qualitative assessment of impact on public transport journey reliability
			Improved freight journey time reliability to the Airport and (surrounding) business district	Qualitative assessment of impact on freight journey reliability
			Improved corridor productivity on approaches to the Airport and (surrounding) business district	Public transport travel time in peak from model and the impact on productivity
			Connected key airport and (surrounding) business district areas, including employment	Qualitative assessment, GIS mapping
			Useful additional capacity	Volume at key screen lines from model

Key:  SMART  CAP  New

Source: CAP programme business case; Auckland Transport SMART Business Case; L.E.K. analysis

# This framework was used for the MCA of the two ABS options developed against one another to ensure alignment with CAP / SMART (2 of 4)

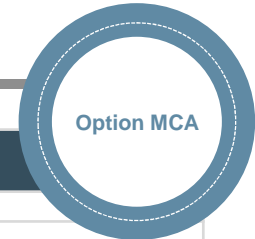

Theme	Sub-theme (if applicable)	SMART / CAP objective	Evaluation criteria	Metric / scale to be assessed
2 Network efficiency, reliability and resilience (cont.)	B In the Mangere-Otahuhu area	Improve the accessibility and transport choice in the Māngere-Ōtāhuhu area	Increased public transport patronage on the local network	Local public transport patronage from model
			Reduced congestion on the local network	Congested VKT from model
			Improved connectivity and transport choice in the wider Mangere area	Qualitative assessment of connectivity
			Ability to provide a cycle metro facility within the State Highway corridor	Qualitative assessment on ability to provide cycle metro facility
			Ability to integrate with local active mode networks	Qualitative assessment on ability to integrate
	C In the city centre	More efficient and cost effective transport network and services	Increased travel efficiency in city centre	Peak and off-peak travel time, by mode, between selected origins and destinations
			Increased travel reliability	% fare box recovery on public transport
			Increased public transport user customer experience	Travel time variability by mode – peak and off-peak
	D New technology	Efficient use of Information	Increased customer decision making ability as a result of real time information	Travel time variability by major corridor – peak and off-peak
			Increased customer satisfaction due to real time information	Qualitative assessment of expected customer satisfaction ratings
3 Liveability and safety	A To / from Airport and city centre	Contribute positively to a liveable, vibrant and safe city	Increased customer decision making ability as a result of real time information	Number of bus passengers left behind
			Increased customer satisfaction due to real time information	Qualitative assessment of how much better customers can make decisions due to real time information
			Safety impacts	Qualitative assessment of safety impacts
			Personal security	Qualitative assessment of personal security
			Visual impacts	Qualitative assessment of visual impacts
			Contribution to positively to local character	Qualitative assessment of contribution to local character
			Contribution to the Airport as a 'gateway'	Qualitative assessment of contribution to Auckland as a gateway
			Promotion of street vitality, active street edges and weather protection	Qualitative assessment of street vitality, active street edges and weather protection
			Sufficient space for pedestrian movement and activity	Qualitative assessment of pedestrian movement
			Impacts on heritage buildings and structures	Qualitative assessment of impacts on heritage buildings
			Land take requirements	Qualitative assessment of land take requirements
			Compatibility with the East West Connection alignment	Qualitative assessment of compatibility
			Cultural values impacts	Qualitative assessment of impact on cultural values

Key:  SMART  CAP  New

Source: CAP programme business case; Auckland Transport SMART Business Case; L.E.K. analysis

# This framework was used for the MCA of the two ABS options developed against one another to ensure alignment with CAP / SMART (3 of 4)

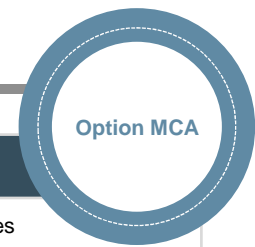

Theme	Sub-theme (if applicable)	SMART / CAP objective	Evaluation criteria	Metric / scale to be assessed
<b>3</b> Liveability and safety (cont.)	<b>B</b> In the city centre	City centre is attractive, vibrant, healthy and safe	Increased safety for all road users	Expected number of deaths and serious injuries in road crashes within the city centre
			Increased city centre amenity	Rating against key amenity criteria
		Sense of place	Urban form	The extent to which the urban form can accept / adapt to change
			Urban character and culture values	The extent to which the proposed options respond positively to the local character and culture
			Heritage buildings or structures and context setting	The extent of impacts on heritage buildings and structures
			Visual amenity in relation to traffic	The extent to which vehicular traffic in city centre streets are reduced
			Visual obstruction	The extent of the view blocked by transport mode from pedestrian / street view perspective
			Visual intrusion	The extent of impact on the streetscape corridor in terms of infrastructure requirements
			Public space / street quality	Access and connectivity
		Comfort & image		The extent of effects on perception of safety and positive image of a place to sit or pass through as a pedestrian
		Use & activity		The extent of uses and activities promoted within the street corridors
		Sociability		The extent people have the ability to socialise, meet or interact

Key:  SMART  CAP  New

Source: CAP programme business case; Auckland Transport SMART Business Case; L.E.K. analysis

# This framework was used for the MCA of the two ABS options developed against one another to ensure alignment with CAP / SMART (4 of 4)

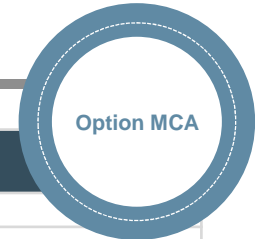

Theme	Sub-theme (if applicable)	SMART / CAP objective	Evaluation criteria	Metric / scale to be assessed
4 Environmental sustainability		Provide a sustainable transport solution that minimises environmental impacts	Emissions effects including greenhouse gases	Emissions based on transport model
			The extent to which the operational noise and emissions of the option affects sensitive receivers	Qualitative assessment of impact on receivers
			Impacts on contaminated land or creates contamination issues	Qualitative assessment of contamination impact
			Impacts to archaeological values	Qualitative assessment of archaeological impact
			The extent to which the option impacts open space and biodiversity	Qualitative assessment of open space and biodiversity impact
			Impacts on non-built environment heritage values	Qualitative assessment of impact on environmental heritage
			Reduction in environmental impacts of transport in city centre	Volume of pollution from vehicles entering the city centre Number of pedestrians and cyclists exposed to transport related pollution over specific levels
5 Implementability		Optimise the potential to implement a feasible solution	The length of time required to construct the option	Qualitative assessment of time requirement
			Constructability	Qualitative assessment of constructability
			The difficulty of consenting the option (planning requirements)	Qualitative assessment of planning requirements
			The impact of construction on network utilities	Qualitative assessment of construction on network facilities
			The amount of temporary land take related to construction	Qualitative assessment of land take requirements
			The impact of construction on transport network operations	Qualitative assessment of impact on transport network
			The ability of the option to be constructed in stages	Qualitative assessment of staged construction possibility
6 Investment affordability		Investment in affordable solutions that provide value for money over the life of the asset	Construction cost – CAPEX (low / medium / high)	Quantitative assessment comparing CAPEX
			Gross operation cost – OPEX (low / medium / high)	Quantitative assessment comparing OPEX
			Expected renewal cost (accrual cost per year)	Quantitative assessment comparing renewal costs
			Fleet cost	Quantitative assessment comparing fleet costs
			Expected farebox revenue	Quantitative assessment comparing expected fare box revenue
			Maintenance cost	Quantitative assessment comparing maintenance costs

Key:  SMART  CAP  New

Source: CAP programme business case; Auckland Transport SMART Business Case; L.E.K. analysis



# For the purpose of the ABS study, all 73 CAP / SMART criteria were reviewed to identify the relevant criteria for ABS to assess in the CBA

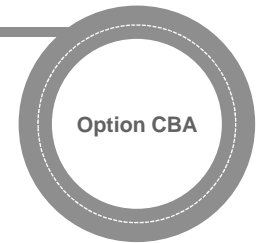

Of these 73 criteria, we will only need to consider, as part of the **ABS option CBA**, criteria that are both:

- solely relevant for bus, and
- have different outcomes subject to the bus solution being evaluated

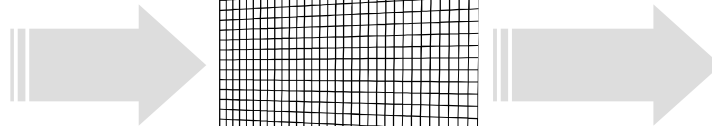

There are **73** evaluation criteria across the **CAP** and **SMART** studies

Looking at the relevant criteria in the CBA will allow us to assess the potential **ABS options** at the required level of detail

# The Cost Benefit Analysis (CBA) was undertaken based on the approach and principles detailed in the NZTA Economic Evaluation Manual

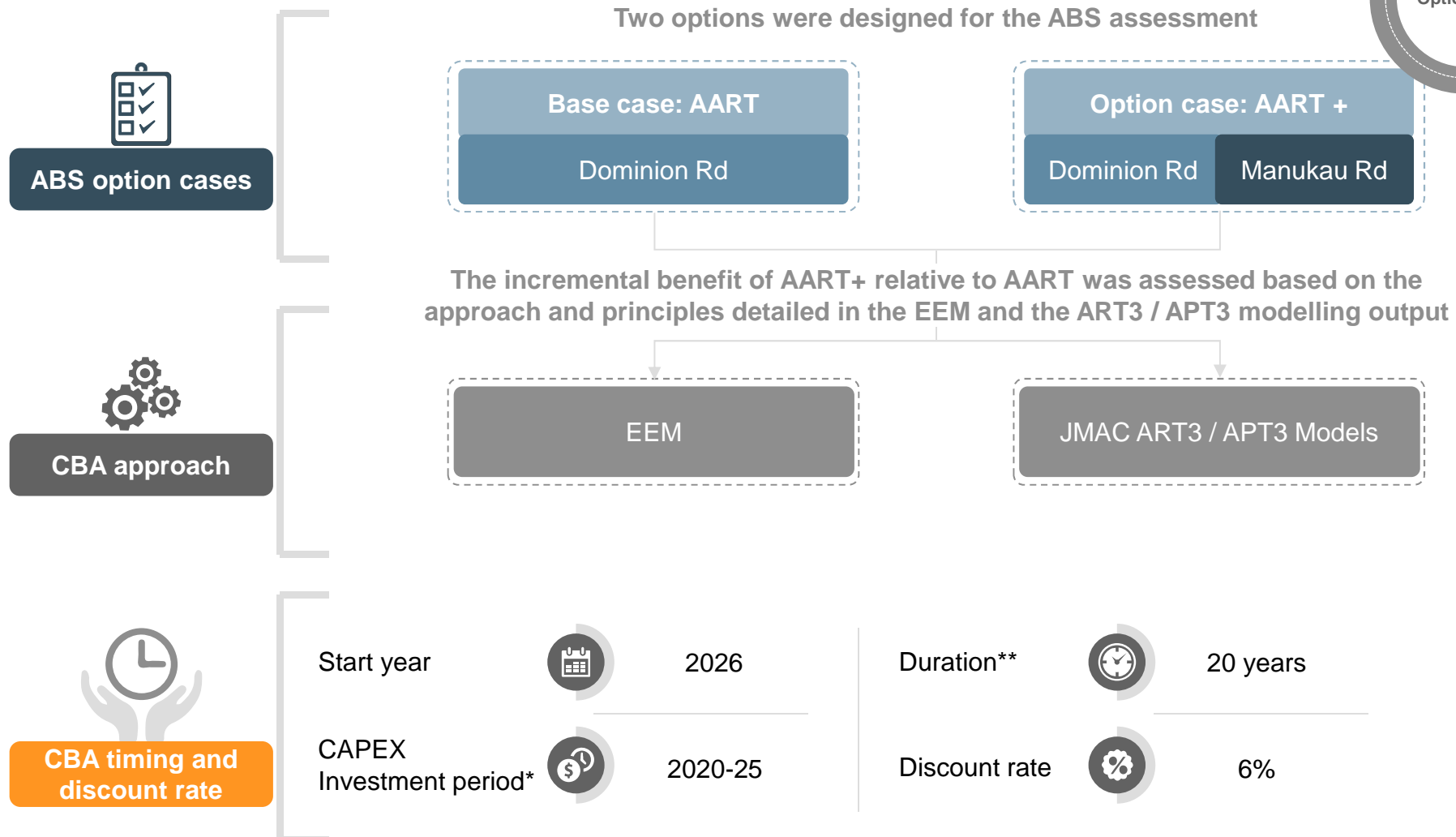
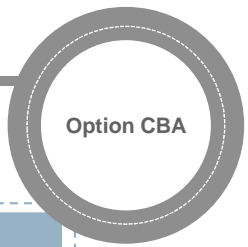

Note: \* Five year construction period with vehicle procurement, testing and commissioning in year 6 (accelerated schedule might be possible); \*\* The CBA base year is 2016 with total CBA evaluation period from 2016 to 2046 and benefit evaluation period from 2026 to 2046  
 Source: NZTA Economic Evaluation Manual; CAP programme business case; Auckland Transport SMART Business Case

## Agenda

---

	<i>Page ref.</i>
● Executive summary	4
● Evaluation framework for the ABS study	15
● <b>Review of current bus solution</b>	<b>26</b>
● Summary of priority initiatives	48
● Outline of ABS options assessed	72
● Assessment of ABS options	197
● Next steps	210

## In Module 2, the CAP and SMART studies were reviewed to identify potential improvements to the bus options examined to date

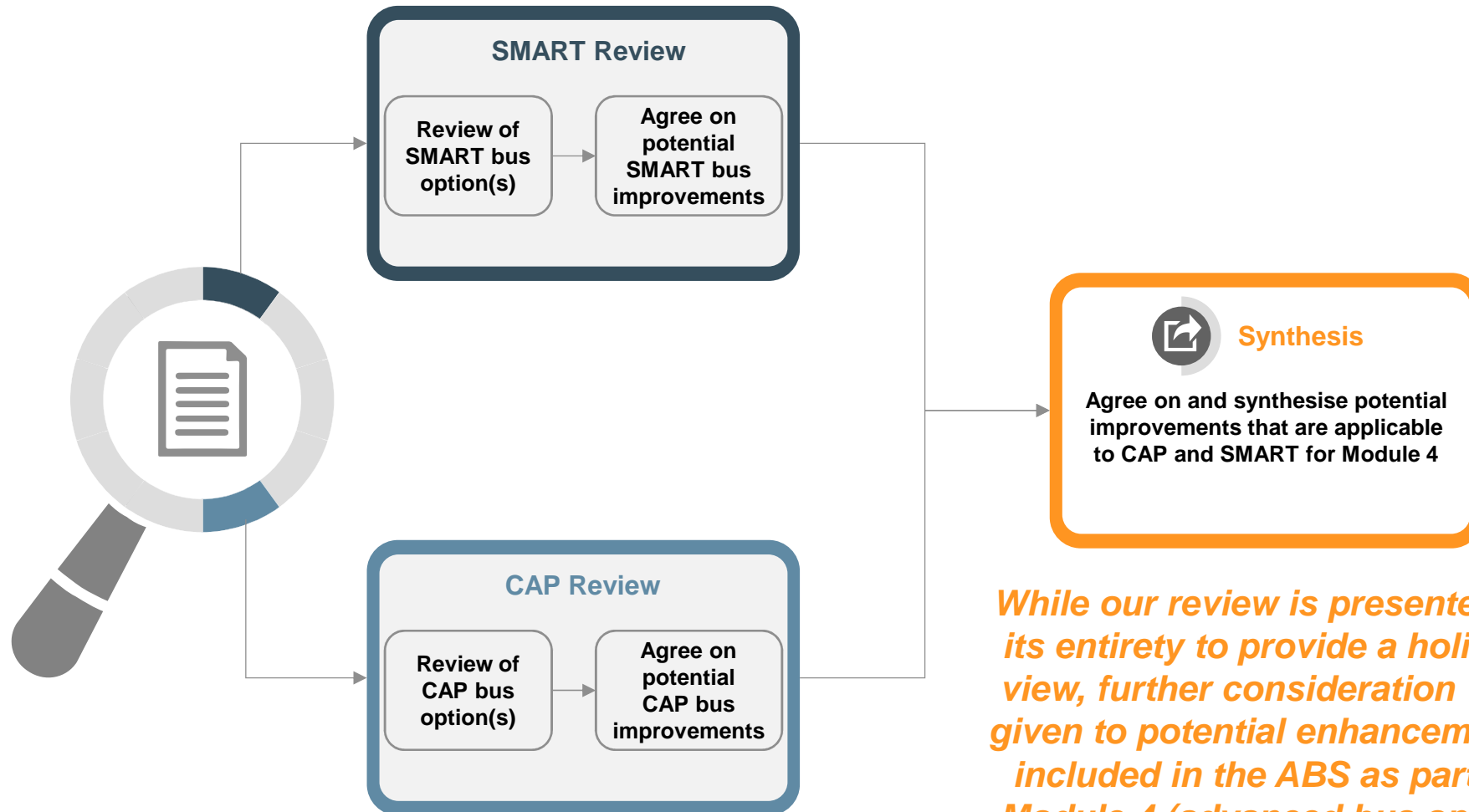

*While our review is presented in its entirety to provide a holistic view, further consideration was given to potential enhancements included in the ABS as part of Module 4 (advanced bus option development)*

## The CAP and SMART studies evaluate different transport options for the Auckland city centre and Airport regions

---

- The SMART (South-western Multi-modal Airport Rapid Transit) study is focused on the Auckland Airport and Mangere-Otahuhu areas and addresses problems around constrained access, limited accessibility and transport choices and unaffordable and inflexible planned transport investment
  - in selecting a preferred bus option the SMART study examined a number of different routes, including Dominion Rd and Manukau Rd, and on these routes full busways and a combination of busway and bus lanes were considered
  - the SMART study is at the Indicative Business Case phase and the detail of work performed to date reflects this relatively advanced status
- The CAP (Central Access Plan) is focused on providing access to the Auckland city centre and addresses problems around the inability to meet current and projected demand, central bus service blockages and delays and high and increasing inner city traffic volumes
  - the CAP study includes a high investment bus / BRT option, an extended bus network option and the integrated programme, which includes LRT and parts of the extended bus network
  - the CAP study is at the Programme Business Case phase so it is not as advanced as the SMART study
- These two studies interface where the Airport connection enters the city centre



Source: CAP programme business case; Auckland Transport SMART Business Case; NZTA website

## The SMART current bus solution includes a busway south of Manukau Harbour and bus lanes from there to the city centre via Manukau Rd

- The SMART current bus solution includes aspects of BRT and runs from the Airport to the city centre
  - the preferred option includes a busway along SH20A and SH20, bus lanes across the Manukau Harbour and along Manukau Rd and a Khyber Pass Rd, Symonds St and Wellesley St routing into the city centre
  - the busway section would be designed to match the standards for the Northern Busway already operated by AT
  - the bus lane section would be designed to match AT bus lane standards
  - BRT high speed stops with passing lanes would be used for the busway section while low speed stops would be used for the bus lane section
- A review of the SMART current bus solution resulted in a number of observations around the assumptions as well as potential improvements

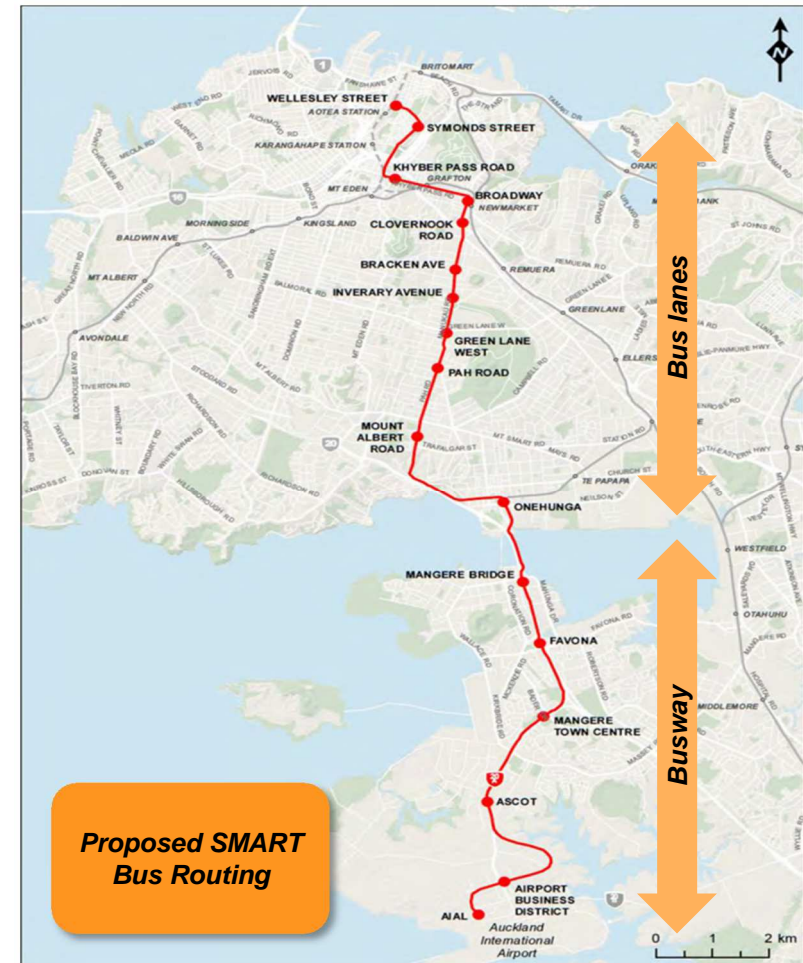

# The CAP Option 2 includes high investment in bus and BRT with the majority of the investment due to the undergrounding of services in the city centre

**A**  **Option 2**  
High investment bus / BRT

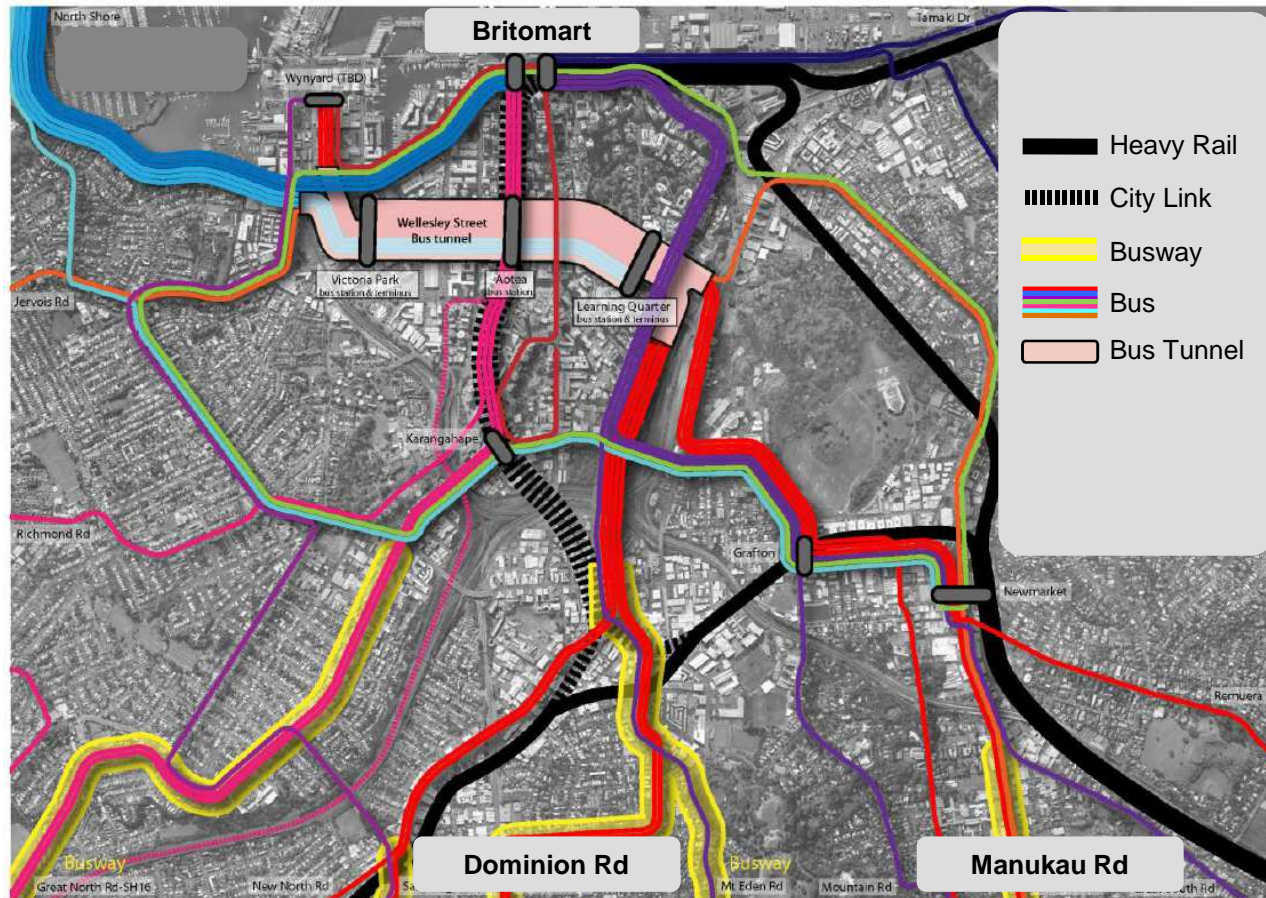

- Includes busways along some of the main arterials, including Great North Rd, Sandringham Rd, Dominion Rd, Mt Eden Rd and Manukau Rd
- Undergrounding of a significant number of bus services in the city centre to improve amenity
- Higher capacity vehicles
- Enhanced services on city centre approach corridors

Source: CAP programme business case

# The CAP Option 6 is an extended bus network with a high capacity bus spine along Queen St and an underground terminal facility at Britomart

## **B** Option 6 Extended bus network

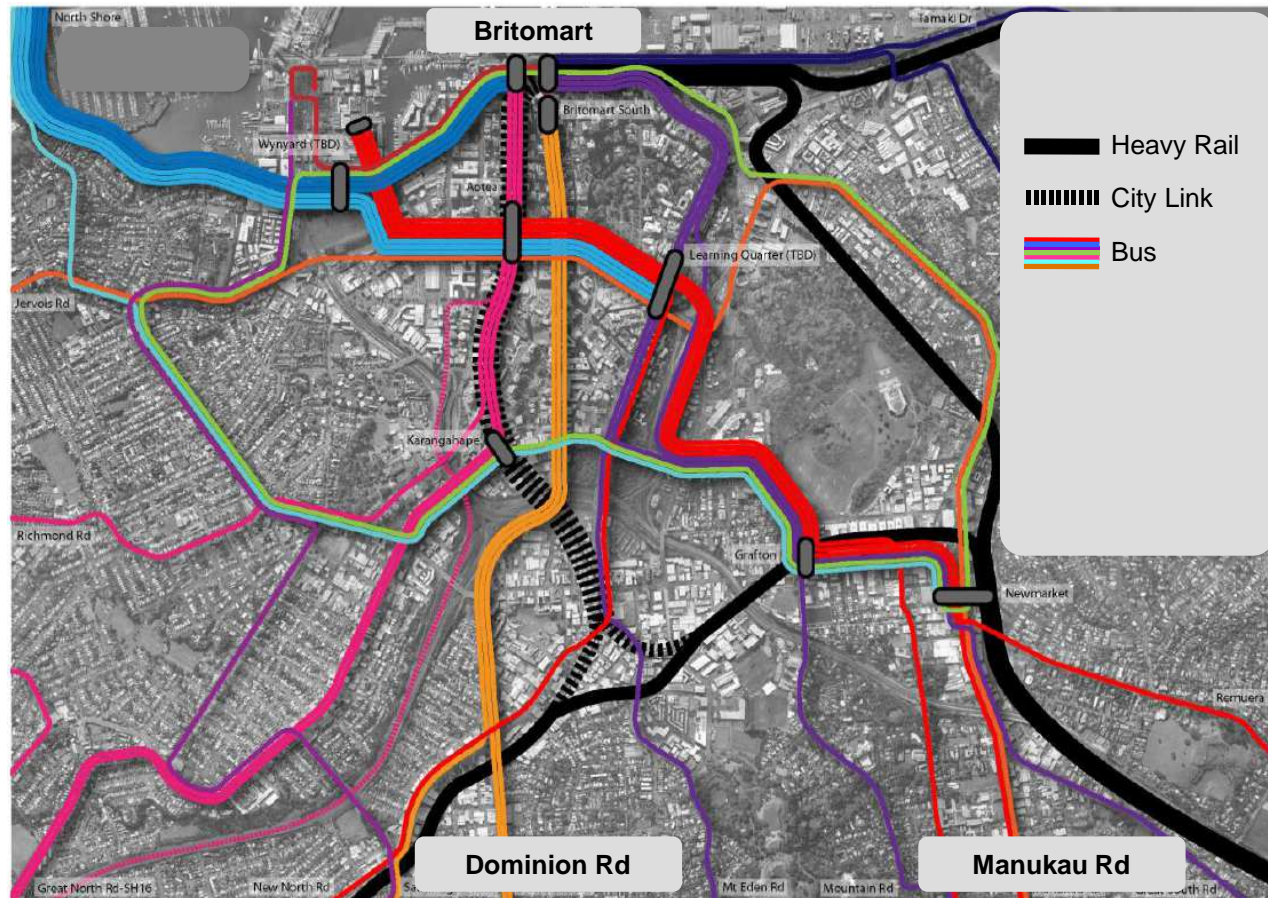

- Includes a high capacity bus spine along Queen St
- An underground terminal facility at Britomart
- All day bus lanes and higher signal priority along Great North Rd, Sandringham Rd, Dominion Rd, Mt Eden Rd and Manukau Rd

Source: CAP programme business case



# The CAP Integrated Programme is similar to the extended bus network with the high capacity route on Queen St and Dominion Rd replaced by LRT

**C** Integrated Programme  
Combined LRT and bus network

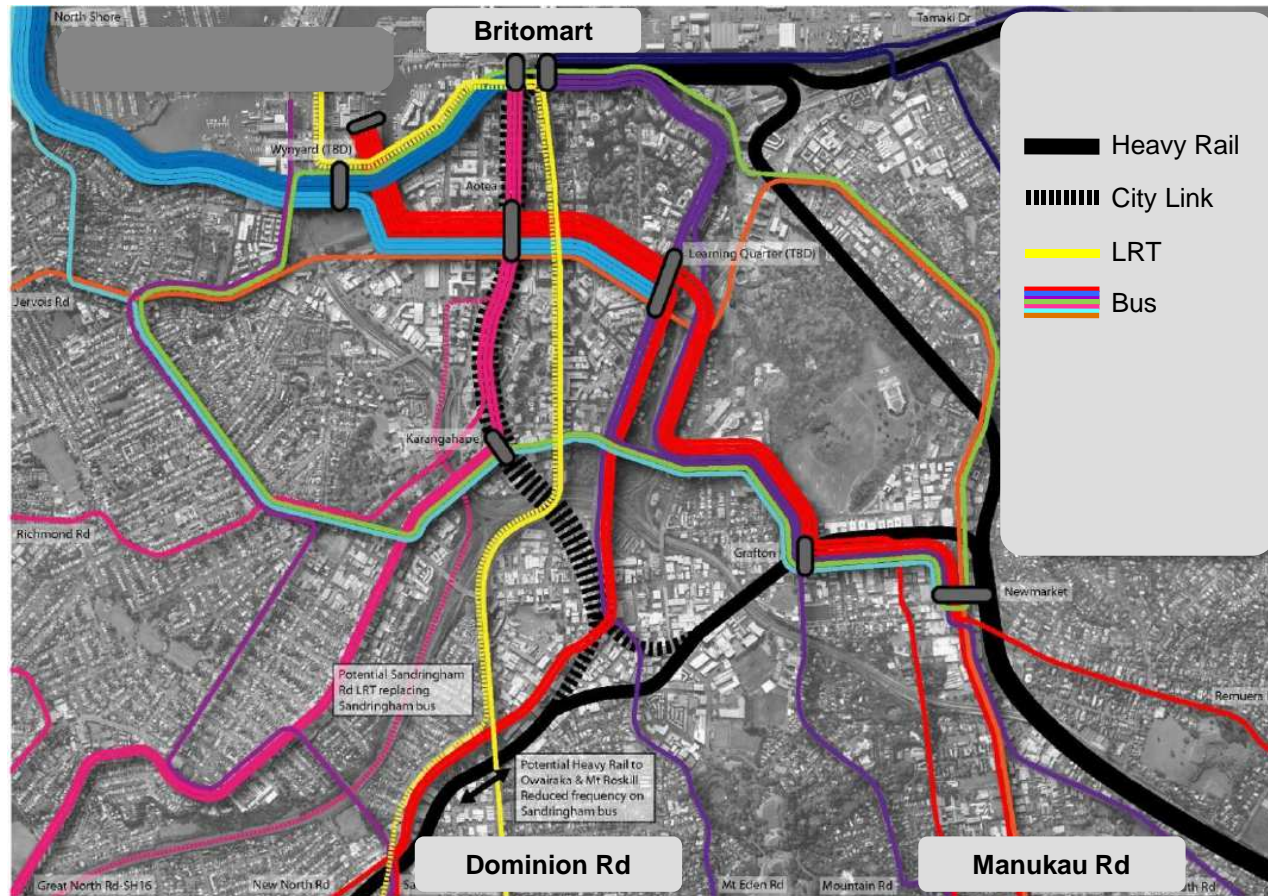

- Prioritises LRT over bus on high capacity corridors
- Looks to optimise current bus plans outside of the high capacity corridors
- Improves efficiency of bus network with a commitment to bus priority and off-board ticket checking
- Includes a high capacity public transport programme on Dominion Rd, likely to be LRT, with a possible second on Sandringham Rd

Source: CAP programme business case

## A review of the SMART current bus solution identified a number of key observations and areas of potential improvement

### *Key observations and potential improvements on the SMART bus option*

S1

The SMART current bus solution appears to not have an adequately defined service plan or problem definition

S2

The SMART current bus solution may not have been accorded adequate dedicated and segregated right of way

S3

The current bus solution does not serve the primary public transport hub, Britomart

S4

Manukau Rd, selected for the current bus solution, may not be the most effective route given the overall project objectives. Dominion Rd has a greater catchment serving both employment and residential zones

S5

The SMART bus solution could consider the merits of serving Puhinui Station and/or the Manukau city centre

S6

The vehicle capacities used in the SMART current bus solution appear much lower than what has been achieved internationally. Higher vehicle capacities can be achieved by using double-decker buses, using longer buses or increasing the standing passenger density

S7

The current bus solution has a large footprint at stops due to passing lanes; however, passing lanes are almost certainly not required at every station, in particular when fleet management is optimised with ITS. Hence, bus station footprint should not be greater than that of LRT

S8

The current bus solution dwell times and service frequencies are set at a flat 60 seconds and two minutes respectively. Both of these can be improved upon

## The SMART current bus solution was assessed against evaluation criteria instead of being developed from a detailed service plan or problem definition

---



### Observations

- A clear problem definition can lead to objective outcomes while evaluation criteria are often subjective
- In SMART the options were assessed against evaluation criteria instead of being assessed against a clear problem to be resolved
- Generally a public transport planning exercise is responding to questions raised by a clear problem definition
  - how many people need to be brought from what set of origins to what set of destinations, by time of day, at different planning years?
  - what is the capacity required at various points, in particular the maximum capacity required at selected parts of the system, at different planning years?
  - what are the desired / acceptable journey times or other key metrics?
  - what are the specific objectives to be achieved by the Airport to CBD corridor?
  - what are the technical, operational and financial constraints within which the project must be designed?
  - what are the (mode neutral) end-user requirements and preferences which the project seek to fulfil?



### Recommendations

- This ABS study should proceed with the evaluation criteria from SMART (in addition to that from CAP); however, future work should consider developing a clear problem definition such that different options can be compared objectively

## The SMART current bus solution may not have been accorded adequate dedicated and segregated right of way



### Observations

- The SMART current bus solution includes a busway from the Airport to Manukau Harbour along the highway and kerbside bus lanes from Manukau Harbour into the city centre
- The dedicated segregated busway offers high speed transport for that section with a 100km/hr design speed
- The kerbside bus lanes offer priority lanes; however, given that there will be some mixed traffic at intersections, travel times increase particularly at peak times
- Dedicated and segregated busways can be implemented in inner city environments using either kerbside or central lanes, reducing travel time and increasing reliability. The preferred lane width would be expected to be 3.65m allowing for an additional 200mm for the lane separator between the right of way and the general traffic lanes
- Note that a benefit of buses is their flexibility and they don't necessarily need 100% dedicated and segregated right of way. For example, if there are technically difficult sections in the central areas, although not ideal, the BRT could operate in different operational configurations (i.e. in mixed traffic)
- It should be noted that the catchment for the different modes differ due to the LRT and BRT operating on different corridors (Dominion Rd and Manukau Rd, respectively)



### Recommendations

- Dedicated and segregated surface lanes into the CBD should be assessed. Any identified time saving(s) should feed into the CBA
- When evaluating mode types, there needs to be consistent catchment numbers and internationally accepted standards for operating speeds and intersection priorities

## The current bus solution does not serve the primary public transport hub, Britomart



### Observations

- The current SMART BRT solution runs from the Airport to Wellesley St in the city centre
- It therefore does not offer a direct connection to Britomart, the most important public transport hub in the city
- The ability to interface with the rail and ferry services from Britomart would better define a comprehensive service model, especially given user preferences for reduction of transfers and the inclusion of an extension of the Northern Busway to Britomart in the 'do minimum' case
- As the BRT enters the central area, buses are sufficiently flexible to accommodate changes in running ways and station designs
- If rail connections shift to Wellesley St, which is a consideration, this option may not offer the same benefits



*Visually appealing Nantes city centre bus system*



### Recommendations

- A BRT option that runs from the Airport to Britomart should be considered

## Dominion Rd has a greater catchment than Manukau Rd, serving both employment and residential zones



### Observations

- Dominion Rd corridor should be the priority for advanced bus
  - it has the largest population and employment catchments
  - the evaluation framework gives greater weighting to the land use and societal benefits in the Dominion Rd corridor
  - the SMART study identifies it as a more attractive corridor
- The CAP study identified Dominion Rd solely as an LRT corridor
- Based on this, SMART has been forced to move the bus route to Manukau Rd, which is deemed less preferable due to catchment numbers
- Dominion Rd with an advanced bus solution should be tested

	Employment and population catchment within 800m of:	
	Dominion Rd	Manukau Rd
Population (2013)	60,240	45,653
Employment (2013)	83,200	63,429



### Recommendations

- Dominion Rd should be used as the preferred advanced bus corridor in order to propose the best solution

## The SMART bus solution could consider the merits of serving Puhinui Station and/or the Manukau city centre



### Observations

- Puhinui Station is only a short distance from the Airport
- This extension would provide a connection to a major rail link that would bring passengers towards the south
- Many Airport area workers live in South and East Auckland and could connect at Puhinui Station and/or Manukau city centre

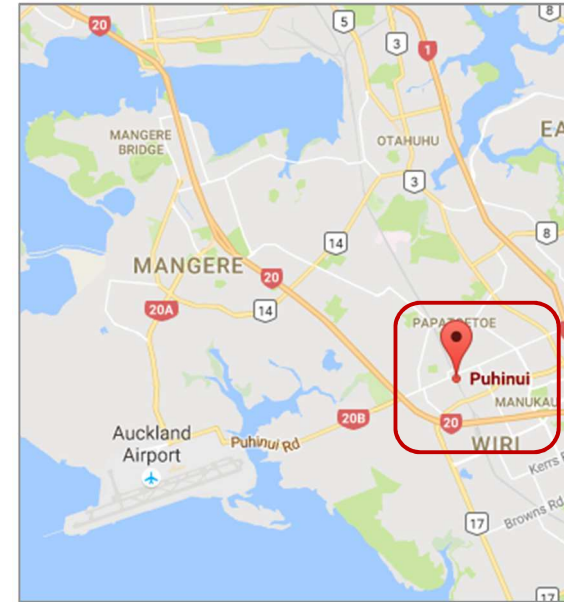

### Recommendations

- An advanced bus option that runs from the Airport to Puhinui Station and/or Manukau city centre should be considered

## The SMART current bus solution vehicle capacities could be greatly improved



### Observations

- The current proposed 12m buses are quoted as having a capacity of 60 passengers. This can be increased to 80 if less passengers are seated
- Double-decker buses have already been implemented in Auckland and form part of the broader New Network plan. They can also be considered for the busway (e.g. Cambridge, UK uses double-decker buses on its busway)
  - double-decker buses have a capacity of up to 100 passengers, mostly seated
  - double-decker buses are very efficient in terms of capacity to footprint ratio
- Longer articulated buses should also be considered
  - 18m and 24m buses can have capacities of 100 to 150 passengers
- Customer preferences should be taken into consideration when establishing the density of standing passengers (i.e. how willing are Aucklanders to travel in standing, crowded conditions and for how long?)
  - note that the capacity of standees can be set to allow for acceptable space requirements, based on short to medium trip length. Beyond peak loading points, users will eventually get a seat



### Recommendations

- Higher capacity bus configurations (in particular double-deckers, which can offer more comfort) should be examined
- Customer survey data should be reviewed to determine willingness to travel in standing, crowded conditions



## Station or stop footprint in the SMART current bus solution should not be greater than that of LRT



### Observations

- If SMART has a single route, passing lanes are not needed. Indeed for multiple routes of similar type, it is not necessarily a problem, unless there are very high frequencies
- The need for passing among routes of similar type (i.e. 'all-stops', standard scheduled speed) should be eliminated by excellent operations management, based on ITS and excellent fleet management
- A detailed service plan will help establish exactly when and where buses would need to pass each other. Based on this, a safe and practical solution that minimises the station footprint can be identified
- Buses are not bound by rails, so they can move into other lanes
  - if there are lateral pairs of platform (i.e. board on the normal side), the buses can pass each other at stops by going in to the oncoming lane. At low to moderate frequencies, this is simple and safe
  - with central platforms, the bus could move out into the general traffic lane and then re-join the dedicated lane
- Single central platform or pairs of platforms, either opposite each other or offset, can be used with BRT. Both of these platform options require the same footprint, as do other modes, to accommodate waiting passengers
  - however, the footprint for kerbside stops in the business case design has a 4.0m platform and a 2.0m footpath. For median stations, a single 3.5-6.0m wide platform could be used for both directions, potentially saving 2-3.5m of the required platform width



*Central platform, Mexico City*



### Recommendations

- Advanced bus stops should not be identified as having additional space requirements at stops with respect to LRT

## The SMART current bus solution dwell times at stops can be improved and service frequencies can be increased



### Observations

- The SMART study identifies dwell times as a flat 60 seconds and this can be improved
  - 60 seconds is excessive even without the introduction of additional technologies
  - a 10 second reduction in dwell can cut 10% off the journey time which is likely to have a significant impact on time travel benefits
  - more accurate dwell times can be obtained from analysing boarding and alighting times and incorporating deceleration and acceleration time losses
- The SMART service frequency is identified as a flat two minutes and this can be improved
  - this figure of two minutes, as the shortest interval at which bus services can be managed, does not consider that multiple routes can overlap on the BRT running way with a much higher combined frequency
  - in central Seoul, there are about 250 buses per hour even in the off-peak, which means headways of less than 15 seconds. These buses are on multiple routes with much longer individual headways



### Recommendations

- The travel time benefits should be reviewed for reduced dwell times as well as the associated possible reduction in capex and opex given that the number of buses to provide the same service should reduce
- It should be noted that a service frequency of two minutes is not a valid limitation on bus

## A review of the CAP bus options has identified a number of key observations and areas of potential improvement

### *Key observations and potential improvements on the CAP bus option(s)*

C1

Assessment of CAP options could have benefited from a greater emphasis on users and their preferences

C2

Bus systems could be developed such that they can be evaluated in a more positive light against the CAP amenity evaluation criteria

C3

It is likely that the city centre streets could handle the required bus movements with higher frequency over the peak periods and less concentration on particular streets

C4

An additional advanced bus option running at surface level should be evaluated

C5

The identified terminal capacity limitations may be addressed with through-routing of services, use of fleet management software and improved procedures

## Assessment of CAP options would have benefited from a greater emphasis on users and their preferences



### Observations

- The options were assessed primarily from the perspectives of movement and amenity
- While these are undoubtedly important, greater emphasis should be placed on how the options meet user needs as well as how the services would function in practice
  - the CAP study does not appear to clearly set out the distribution of user destinations in the city centre and where they are coming from. These user travel requirements would provide a clear quantitative problem definition against which each of the options could be evaluated
  - similarly, the study does not appear to set out how many people come into the city centre to transfer in order to reach a final destination other than the city centre
  - user preferences about public transport do not appear to be set out. Even if they were incorporated into the evaluation criteria, it may be beneficial for the assessment of options to clearly state these preferences
  - CAP states that a journey time of under 45 minutes, as well as user comfort and facilities, is key to ridership demand. However, users may accept a higher journey time if reliability is improved



### Recommendations

- User travel requirements and user preferences should be clearly set to provide an objective framework against which the different mode options can be compared. This would be in addition to the equally important evaluation criteria

## Bus systems can be developed such that they can be evaluated in a more positive light against the CAP amenity evaluation criteria



### Observations

- The amenity criteria have a significant level of focus in the CAP study, emphasising its importance to the city of Auckland and its residents
- Buses have been evaluated with a dated view (e.g. old bus shapes with diesel engines)
- Advances in bus propulsion technology and suitable design features of buses and bus stops should result in bus solutions being viewed in a much more positive light



*CAP image demonstrating 'Symonds St already exceeds acceptable levels for visual amenity' based on old technology buses*



### Recommendations

- Amenity criteria should be evaluated looking at the latest technology buses
- Given the importance of amenity, advanced bus shapes and bus stop designs may be required

## The city centre streets could handle the required bus movements with higher frequency over the peak periods and less concentration on particular streets

---



### Observations

- Higher bus frequencies may be achievable in Auckland over the peak period if the street-space is not already allocated to many other uses
  - a higher level of signal prioritisation, advances in ITS and customer handling improvements may help achieve the desired frequencies
- Decisions have been driven by a few bottleneck streets in the central area. Street space is an issue but further work could be done to spread out the load
  - it is unlikely that the destinations of all passengers entering the CBD are on these bottleneck streets
  - however, it is also acknowledged that in places there will be limitations on motorway access, limiting the opportunity to spread the load



### Recommendations

- The new bus reference case in 2017 should consider whether the street space can accommodate the desired advanced bus network based on signal prioritisation, advances in ITS and customer handling improvements as well as spreading the network away from the few bottleneck streets

## C4 An additional advanced bus option running at surface level should be evaluated

---



### Observations

- Following on from the review of amenity and street space, it may be appropriate to propose an additional CAP option including advanced bus running on street level
- This option would
  - incorporate busways on the main arterials,
  - remove the tunnel
  - run the Dominion Rd and Sandringham Rd lines on Queen St to Britomart
  - run the other lines on the routes proposed in the extended bus network
- The Northern Busway lines and the southern SMART line could then connect at Britomart, providing connectivity across the city and to the Airport
- The proposed tunnel in Option 2 (i.e. the BRT option), aimed at improving amenity due to an assessment of old bus features, is an extremely expensive option. Removing this tunnel would result in a more attractive investment proposition



### Recommendations

- An additional surface level advanced bus option should be considered

## The identified terminal capacity limitations may be addressed with through-routing of services, use of fleet management software and improved procedures

---



### Observations

- Britomart terminal has limitations for bus layover due to:
  - the terminal design being linear
  - long dwell times (over two minutes) for each route
  - occurrences of multiple vehicles per route
  - protracted driver change over
- The number of through-routed buses could be increased, which reduces required layover at Britomart
- Dynamic management of services through fleet management software could reduce terminal dwell times and better manage multiple vehicles per route and driver change over
- Layovers in port areas to the north-east of Britomart could be used especially for out of service buses
- Centralised waiting and provision of dynamic stop allocation can be introduced at the terminal
- Operational procedures for the driver can be improved including engine shut down for all buses that dwell in Britomart



### Recommendations

- The terminal capacity constraints should be revisited considering through-routing of services, advances in fleet management software and better operational and driver change over procedures



## Agenda

---

	<i>Page ref.</i>
● Executive summary	4
● Evaluation framework for the ABS study	15
● Review of current bus solution	26
● <b>Summary of priority initiatives</b>	<b>48</b>
● Outline of ABS options assessed	72
● Assessment of ABS options	197
● Next steps	210

## The current and emerging initiatives relevant to advanced bus solutions were assessed across four key pillars

---



1

Infrastructure



2

Vehicle technologies



3

ITS technologies



4

Customer interface

## The current and emerging initiatives that were assessed under each of the four key pillars were as follows



1

### Infrastructure

- (A) Flexible stop design
- (B) Dedicated right of way
- (C) Advanced bus stop design



2

### Vehicle technologies

- (A) Amenity, internal configuration
- (B) Advanced shape
- (C) Propulsion systems
- (D) Guided busway
- (E) Guided docking
- (F) Platooning
- (G) Autonomous vehicles



3

### ITS technologies

- (A) Automatic vehicle location
- (B) Intelligent priority signalling
- (C) Fleet management systems
- (D) Data analytics – payments, journey, traffic
- (E) Dynamic scheduling



4

### Customer interface

- (A) Customer experience
- (B) Connectivity

## The assessment highlighted nine initiatives that would be key for the proposed ABS option(s)



1

### Infrastructure

- (A) Flexible stop design
- (B) Dedicated right of way
- (C) Advanced bus stop design



2

### Vehicle technologies

- (A) Amenity, internal configuration
- (B) Advanced shape
- (C) Propulsion systems
- (D) Guided busway
- (E) Guided docking
- (F) Platooning
- (G) Autonomous vehicles



3

### ITS technologies

- (A) Automatic vehicle location
- (B) Intelligent priority signalling
- (C) Fleet management systems
- (D) Data analytics – payments, journey, traffic
- (E) Dynamic scheduling



4

### Customer interface

- (A) Customer experience
- (B) Connectivity

*Detail around each initiative can be found in the Appendix pack*

# Flexible stop design can create a more effective boarding / alighting for passengers whilst making most effective use of the respective environment

## A Flexible stop design

***Description: Corridor station locations optimised to meet demand and amenity requirements***



### Key considerations

- Central stations to be located close to existing traffic signal controlled intersections to enable passenger access
- Central station locations facilitate space requirement reductions by efficient use of a combined 3.0-5.0m wide station
- Split / offset / side platform stations can provide for minimised impact in width constrained locations along the corridor
- Stations become easily identifiable with increased legibility due to branding and iconic design
- Stations provide level boarding with little or no gap for all passengers
- Ticketing at stations ensures minimised bus boarding and alighting times by providing off-board ticket validation
- Specialised vehicles required for central platform stations (e.g. doors on both sides)
- Possible issue of increased conflict points between passengers and vehicles for central boarding requires mitigation through management of pedestrians at the key intersections
- Only specialised bus vehicles can stop at central platform stations but other buses could still avail of the running way on an express basis
- Coordination of the use of flexible locations and dedicated rights of way ensure that the capacity for the system can be delivered for peak loading locations along the ABS corridor

# Stations for BRT can be inserted into a variety of different running way configurations

## A Flexible stop design

### Case studies

#### Cleveland, USA



Central station



Side platform station offset across intersection

#### Istanbul, Turkey

- Carries 750,000 passengers daily, freeway median



#### Lane County, USA

- BRT system with single lane transit way in peak direction for some segments
- The stations on single lane segments can accommodate buses travelling in either direction



#### Pereira, Colombia

- Operates partially in narrow, pedestrian oriented environments



# Dedicated travel lanes help transform bus networks into dedicated mass transit routes by minimising conflict with other modes of transport

## B Dedicated right of way

***Description: Improved priority and therefore service reliability***



### Key considerations

- Comparable with other options that define the corridor as a dedicated mass transit route
- Minimises conflict with other modes of traffic and therefore improves travel time and travel time reliability
- A façade to façade approach can be taken to improve urban amenity and pedestrian facilities
- Dedicated lane provides for bus priority and dedicated bus priority at all traffic signal intersections (existing or proposed)
- Introduction of the right of way may impact upon corridor capacity for other modes and may change the characteristics of that corridor
- Increased costs due to requirement of concrete pavement (feasibly all options would require such works) but these might be mitigated by only providing concrete pavements at the station locations
- Potential issues of broken down vehicles require mountable lane separator in the instances of single lane rights of way through the station sections
- Outside of the station locations, a median ABS solution enables passing opportunities
- There is the potential to include both enforcement solutions and dynamic lane tolling as part of the dedicated travel lanes initiative

# 1 There are various examples of dedicated BRT rights of way around the world

## B Dedicated right of way

### Case studies

#### Guangzhou, China

- Carries a peak passenger flow of 26,900pphd



#### Istanbul, Turkey

- Right of way constrained to freeway median



#### Seoul, South Korea

- Single lane each direction, median transit ways. In 2011, carried a peak passenger load of 8,400pphd



#### Nantes, France

- The BRT in Nantes, France acts as the fourth 'LRT' line and carries c.3,000 pphpd
- The BRT system transforms its nature along the line and is constrained by having to get through traffic signals
- Average operating speed for this and all other ROW examples are 23 – 27km/h





## Alternative propulsion systems offer a smoother, quieter, improved journey for customers as well as cost-savings for operators relative to standard buses

### (C) Propulsion systems

***Description: Alternative propulsion systems including electric and hybrid buses***



#### Key considerations

- Electric propulsion vehicles have relatively high capex compared to conventional diesel or hybrid diesel buses
- Reduced opex due to decreased maintenance required and the lower cost of electricity compared to fuel
- Improved environmental benefits through reduced emissions, noise reduction and associated health benefits with reduced particulate pollution
- Supports New Zealand's position as a leader in renewable energy
- Electric propulsion allows more opportunities for 100% level floor, wide-aisle interiors
- Potential limited travel distance (current electric city bus technology allows for a travelling distance of 160km+ on a single charge). However, rapid charging technology can provide automatic, fast charging along the route and at termini
- There will likely need to be corresponding changes in the depot-side maintenance operations and training
- The additional costs of charging stations and costs associated with upgrading transformers must also be considered
- The trade-off between whether the ABS should be a high profile pioneer for new propulsion systems or if it is more prudent to let these technologies be trialled elsewhere on the network before using them on high intensity and high profile services
- With shorter vehicle replacement cycles, propulsion systems can be updated quickly to avail of market ready technology at more competitive prices; new buses can be brought into the fleet and mid-life BRT buses can migrate to other services

## 2 Volvo has recently announced its first UK order of full battery electric buses

### C Propulsion systems

#### Case studies

##### Volvo Bus

- Volvo has been producing its 7900 hybrid electric bus since 2011, which operates on a relatively large lithium ion battery that can utilise Volvo's 'opportunity charging system'
  - according to the manufacturer, the bus can operate in full electric mode for 70% of the route
- Volvo has recently announced its shift towards full electric buses, receiving its first UK order, supplying eight 7900E buses to Harrogate, UK



Volvo 7900 plug-in hybrid electric bus

##### Other international propulsion examples



BYD articulated battery electric bus (China)



ExquiCity battery electric bus for Hamburg (Belgium)



Proterra Catalyst battery electric bus (US)



BYD electric double-decker battery electric bus for London (China)



New Flyer battery electric bus (Canada)

## Guided busways can help to improve operating speeds, but the extent of this will depend on the type of guidance system used

### D Guided busway

***Description: Kerb, optically and magnetically guided buses***



#### Key considerations

- Suitable for a constrained corridor (kerb-guided)
- There is potential for the corridor to allow for faster operating speeds (kerb-guided) although this is likely to be outside of the CBD
- Buses can easily join the guided busway fleet (kerb-guided)
- The system is flexible, as demand increases, more buses can be added to the system (kerb-guided)
- Buses can join the busway at various entrances, providing a variety of single seat journeys
- Safety and efficiency improvements when docking with stations (optically guided); however, there are reliability issues due to 'obscuring' or interference with the road markings (optically guided)
- Magnetic guidance has had an unsuccessful track record of implementation
- Optically guided buses have limited operating speeds
- Special training is required for drivers on the guided busway (kerb-guided)
- Regular maintenance is required for the physical 'track' and the guided wheels (kerb-guided), which may have increased opex costs
- The capex required for the kerb-guided track is higher than for a standard roadway
- It is difficult to provide crossings for other vehicles and pedestrians due to the high bus operating speeds (kerb-guided)
- The visual aesthetic of a track must be considered, as this has been identified as a potential barrier to implementation (kerb-guided)
- Kerb guided busways are more suited to corridors without traffic lights and with stations that are positioned relatively far apart so that the benefit of increased operating speeds are realised

Source: L.E.K. research and team expert interviews

## Kerb-guided busways have been successfully implemented in Adelaide and Cambridgeshire

### D Guided busway

#### Case studies

##### Adelaide, Australia



- The primary objective of the O-Bahn City Access Project was to improve travel times and reliability in an area with significant space constraints due to its location in a linear park
- Opened in 1986 as a segregated BRT, the O-Bahn operates over a 12km length, carrying an estimated 31,000 passengers each weekday
- Kerb-guided busways have been effective in providing a low cost alternative to other options, with safety and operating speed benefits in addition to the benefit of requiring only a limited corridor width

##### Cambridgeshire, UK



- Was the longest in the world when it opened in 2011, it now carries three million passengers per annum
- The operator has increased the fleet by 55% since the start of operations and services now operate at seven to eight minute frequencies at peak times
- Extensive expansions are planned to the system to connect key generators such as Addenbrooke's Hospital and to Trumpington Park and Ride along the course of the old Bedford railway line

## Optical guidance systems allow buses to follow a defined path without the need for on-street infrastructure

### D Guided busway

#### Case studies (cont.)

##### Rouen, France

- Rouen is a city of 530,000 people and has a historic and densely developed city core
- The BRT system operates with 110 – 115 capacity vehicles that are 18m in length
- Operates a five minute headway in the peak periods and has a peak hour ridership of 1,770pphd for the T3 line
- The optical guidance is only used for docking at the stations



##### Castellon, Spain

- The Siemens Optiguide system has been operating on the Castellon Trolleybus (Línea 1 - TRAM de Castellón) since 2008
- Two lines were planned with a total length of 42km; to date, just a 2km stretch has been implemented between the city centre and the university
- Ridership on the Castellon system is 3,200 passengers per day
- A key motivation of the optical guidance system was to ensure that a consistent driving path was followed in narrow streets
- An electric trolley bus propulsion system is used



## To date, connected vehicle platooning technology development has been mainly limited to trucking applications

### F Platooning

***Description: Bus platooning (training) supported by vehicle to vehicle communication***



#### Key considerations

- Network capacity improvements due to reduced bunching
- There are potential safety improvements due to a reduction in the likelihood of rear end collisions
- Connected vehicle platooning may lead to reduced emissions / pollution
- Connected vehicle platooning may lead to lower opex than conventional systems due to fuel savings
- Improved network efficiency and minimised intersection impacts; facilitates signal priority
- Incorporation with other technologies (e.g. autonomous vehicles)
- Additional technological development / refinement required for connected vehicle platooning
- Requires social adoption of semi-autonomous technology and there are associated ethical concerns
- Connected vehicle platooning may cause confusion for other road users and therefore would be adopted only within the scenario of a dedicated right of way
- Connected vehicle platooning track record mainly limited to trucks thus far
- If informal platooning were to be considered, careful scheduling and supervision aided by an advanced operations and signal priority system would be required
- Government regulation / legal considerations

## Buses are dispatched as platoons on the BRT system in Istanbul. Connected platooning technology is being applied to trucks in Europe

### F Platooning

#### Case studies

##### Istanbul, Turkey

- Dispatching platoons rather than individual vehicles increased capacity on the Istanbul BRT line from c.20,000 pphpd to more than c.25,000 pphpd



##### European Truck Platooning Challenge

- The EU Truck Platooning Challenge 2016 was an initiative of the Dutch Ministry of Infrastructure and the Environment where a European partnership was forged between truck manufacturers, the technology community, industry and governments to realise truck platooning on public roads, crossing borders from several European cities to the Netherlands



Source: L.E.K. research, interviews and team expert interviews; European Truck Platooning Challenge

## Autonomous vehicles can offer an array of benefits to a transport network; however, additional technological development is still required

### G Autonomous vehicles

***Description: Connected autonomous buses, with low human input***



#### Key considerations

- Ride improvement for passengers, due to the smooth nature of operation due to computer management (akin to a train)
- Lower fuel cost due to predictive driving
- Perceived improved safety for passengers and other road users (e.g. cyclists)
- Incorporation with other technologies (e.g. platooning, guided docking, advanced shape, amenity and internal configuration)
- Additional technological development required for other autonomous vehicle modes and requires social adoption of autonomous technology
- There are perceived issues of cyber security and hacking
- Autonomous vehicles are likely to require a driver / attendant for some time, meaning labour costs will not initially decrease
- Government regulation / legal considerations
- The transition period needs to be managed carefully, as autonomous vehicles interact with non-autonomous vehicles
- There needs to be tight alignment in the views of the government, transport authorities and operators
- GPS or GPSR authentication capability needs to be considered to ensure sufficient accuracy is delivered
- Aids collision avoidance and lane adherence



## Mercedes-Benz has recently unveiled its Future Bus, making a journey in a real-life traffic situation in Amsterdam

### G Autonomous vehicles

#### Case studies

##### Mercedes-Benz Future Bus

- Unveiled in July 2016 and based on technology in Mercedes-Benz autonomous trucks, the Future Bus is able to drive itself along suitable routes, communicate with traffic lights to cross intersections and automatically dock with stations
- The Future Bus recently made a 20 kilometre trip from Amsterdam's Schiphol Airport to the nearby town of Haarlem, which makes it the first automated city bus tested in a real-life traffic situation



##### EU CityMobil2 Project

- CityMobil2 is a European Union (EU) funded research project whose main goal is to remove barriers to deployment of a fully-automated bus / shuttle, with a budget of USD \$16.9m
- The project involves demonstrations and showcases of small autonomous shuttles in 10 cities across Europe (two day to six month long demonstrations)

##### CityMobil2 showcases / demonstrations

City, Country	Type	Year
Leon, Spain	Showcase	2014
Bordeaux, France	Showcase	2015
Warsaw, Poland	Showcase	2016
Oristano, Italy	Small Demo	2014
Vantaa, Finland	Small Demo	2015
San Sebastian, Spain	Small Demo	2016
Sophia Antipolis, France	Small Demo	2016
LaRochelle, France	Large Demo	2014 / 15
Lausanne, Switzerland	Large Demo	2014 / 15
Trikala, Greece	Large Demo	2015 / 16

Source: L.E.K. research; National Centre for Transit Research; Daimler

## Intelligent priority signalling improves the customer experience and can help to reduce operating costs

### B Intelligent priority signalling

***Description: Extended green time / actuation of green light at intersection***



#### Key considerations

- The benefits from using priority signal improvements include reduced transit travel times, improved schedule adherence, improved transit efficiency and increased road network efficiency as measured by person mobility
- Provides 'smoothed' journey times and a consistent level of service for customers
- Has the potential to provide a more predictable service for customers
- The system is cost effective, with low capex (if there is appropriate existing infrastructure) and low opex
- Provides additional opportunities for data analysis of vehicles on the network, allowing for issues to be detected along the corridor and managed through conditional priority at the intersections
- The system is dynamic and so there may be coordination issues between junctions; however, the management through SCATS (Sydney Coordinated Adaptive Traffic System) and Automatic Vehicle Location (AVL) systems will allow for minimal impacts and improved management of the system to allow for priority for the ABS corridor
- Existing infrastructure can be leveraged to implement a low cost priority system (e.g. AVL systems and SCATS)
- It is important that there is a standardised format for the AVL system to share data with the centralised priority system (already available at the Smales Farm operations centre for SCATS)
- Level of priority can be set in accordance with the needs of individual services and balanced with other road users

## The Dublin City Council has leveraged existing infrastructure to provide signal priority to buses

### B Intelligent priority signalling

#### Case study

#### Dublin City Council, Ireland

- The Dublin City Council aims to utilise priority signalling to provide smooth journey times and a consistent level of service for customers
- The centralised bus priority module takes a real-time data feed from Dublin Bus and then the system can make a call and uses a predefined control in SCATS to give extended green time or an immediate green to late running buses (**conditional priority management**)

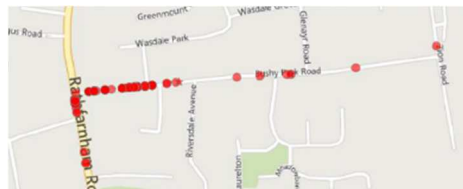

Before intervention

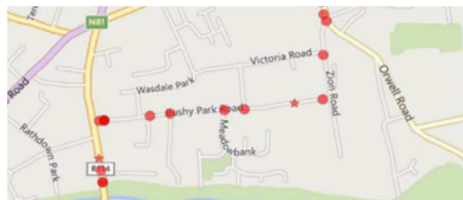

After intervention – more green time given to side road leading to more even headways

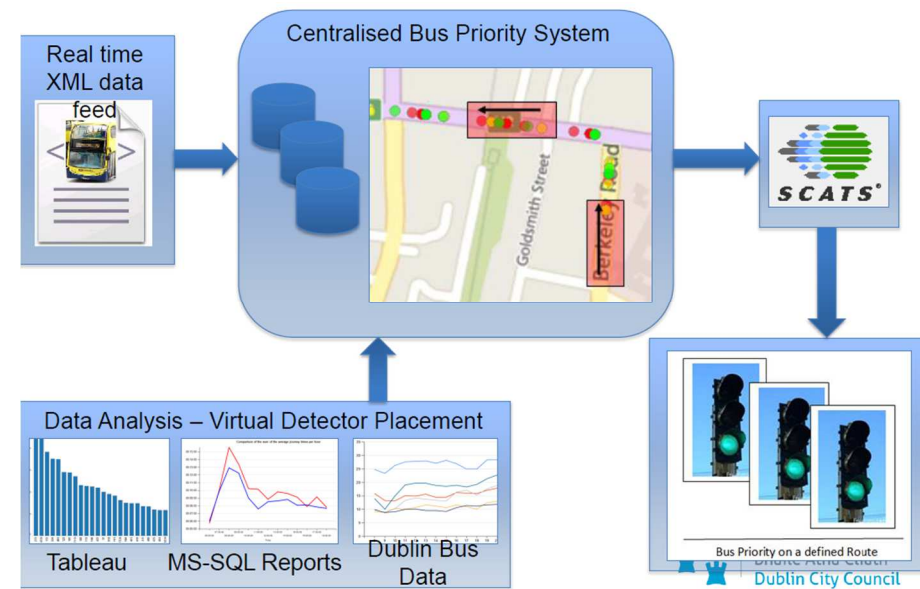

Dublin City Council automatic priority signalling architecture

## Fleet management systems can help to improve service planning, service reliability and increase capacity

---

### (C) Fleet management systems

***Description: Operational management on 'real-time' basis***



#### Key considerations

- The primary objective is to ensure that services perform as planned
- Fleet management systems allow operators to identify variances and to resolve the issues early, avoiding the need for larger intervention as irregularity escalates
- Allows operators to adapt to the demand and traffic conditions of the day
- Ensures transfer and connection protection
- Enables rapid response to emergency, security and other incidents
- Ability to manage service in disrupted and / or diversion situations
- Reliability improvements due active management of headways and control of bus bunching
- Potential safety improvements due to rapid response times
- Incorporation with other technologies (e.g. transit priority signalling, Real Time Passenger Information and AVL)
- Data obtained through fleet management systems can be used for service planning and adherence monitoring

## Transport for London uses the AVL system 'iBus' to monitor the location of their bus fleet

### C Fleet management systems

#### Case studies

##### Transport for London

- London Buses mandates the use of a shared AVL system; the iBus system is installed on every bus and allows both the operator and authority access to real-time information

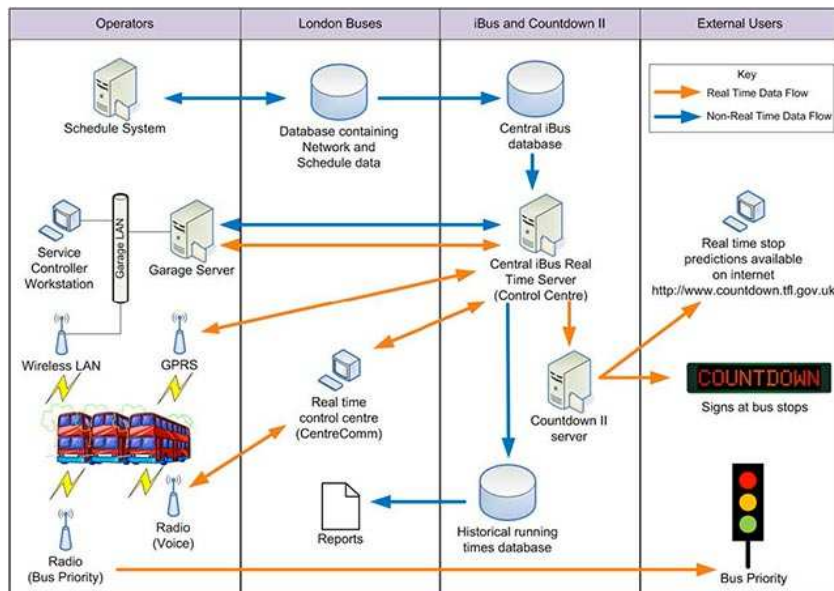

##### GMV Fleet management system interfaces

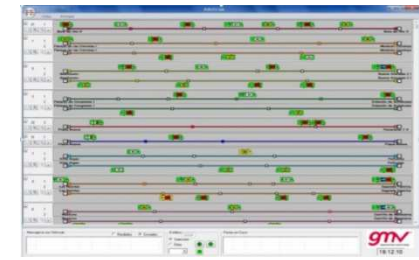

##### Operator interfaces

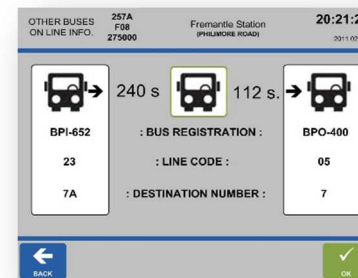

##### Driver interfaces

All parts of the ABS impact various aspects of the customer experience, from before the customer leaves their origin to when they arrive at their destination

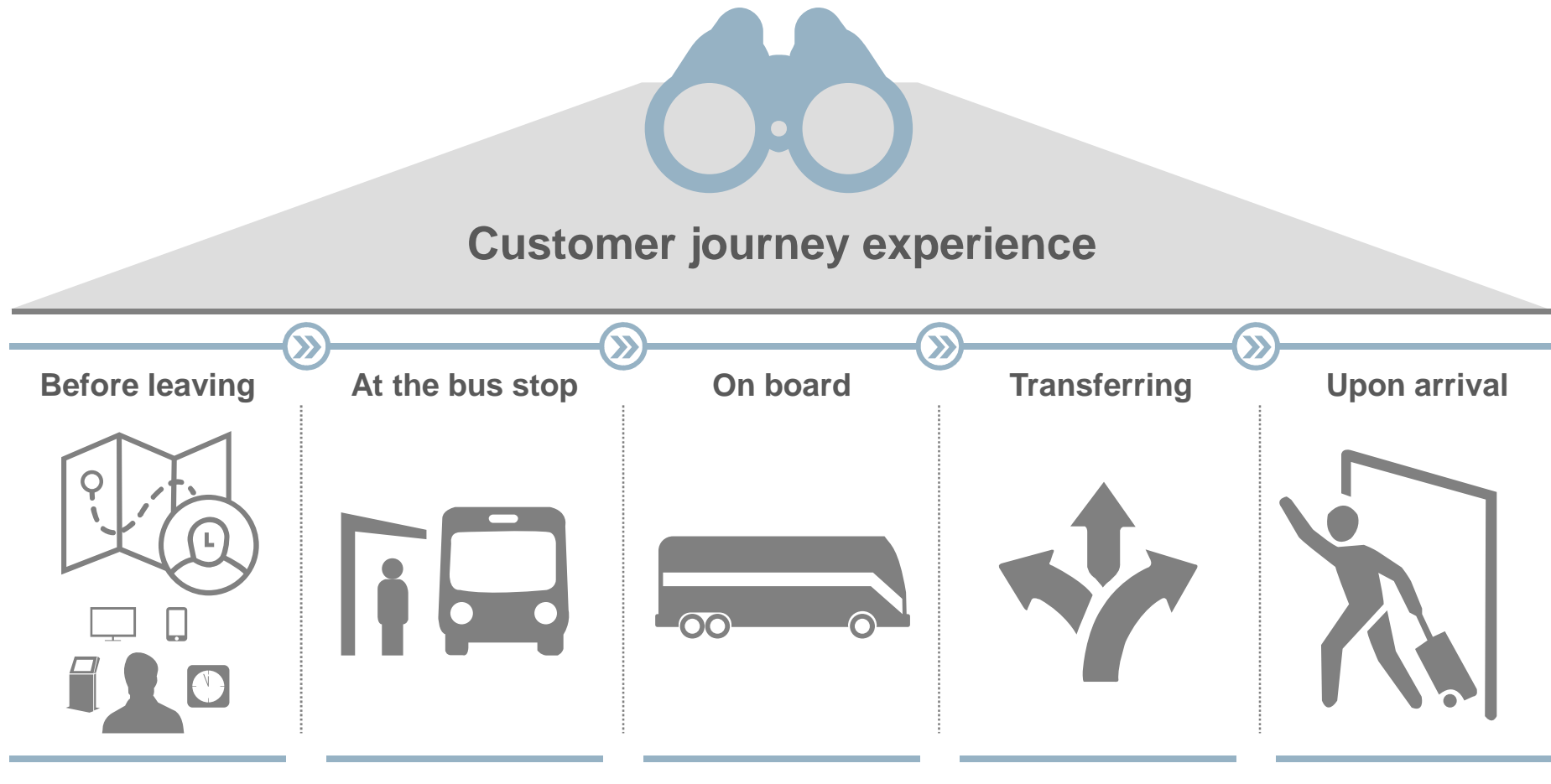

## A variety of initiatives can be used to improve customer experience on a bus network, at varying costs and complexity levels

---

### A Customer experience

***Description: Improve customer experience through implementation of various initiatives***



### Key considerations

- Customer satisfaction, and improving public perception of buses as an attractive mode of transport is driven by:
  - reduced journey times
  - more comfortable journeys resulting from less noise, smoother driving and on-board amenities
  - capacity / space improvements
  - reduced dwell times at stops
  - more accurate arrival and departure information, as well as more effective journey planning
- Most initiatives are easy and cost-effective to implement as well as maintain and must be reinforced through contracts
- The initiatives work best as an integrated package

## Seoul drastically improved its public transport situation in the early 2000s by taking a holistic approach to its reform strategy

### A Customer experience

#### Case study

#### Seoul, South Korea

- In the early 2000s, Seoul was faced with a low quality public transport system and high congestion on its roads due to high growth in population and registered vehicles
- As part of its public transport modernisation / reform strategy, Seoul introduced a range of measures including:
  - addition of median transitways and bus lanes
  - an integrated, multi-modal fare system (with smartcard and open-loop payment systems)
  - central bus operation centres with new systems such as Real Time Passenger Information systems
  - Compressed Natural Gas (CNG) buses instead of diesel



Seoul CBD, 1974

#### Results of the Seoul Transport Reform (STR):

- Increases in:
  - network capacity
  - public transport speeds
  - reliability, safety
  - passenger satisfaction
  - bus and train trips by c.250k per day from 2004 to 2006
- Decreases in crowding, bus opex and accidents

Public transport patronage in Seoul (Jun-04 - Nov-05)  
Millions of passengers per day

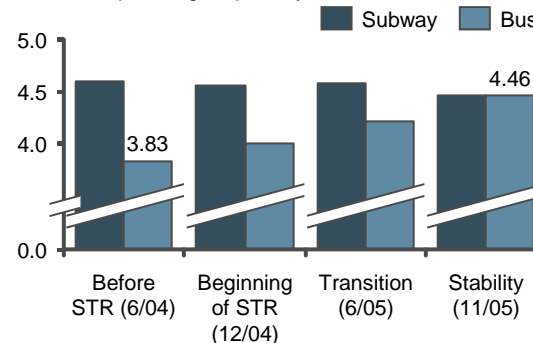

Increase in public bus speed on key roads in Seoul (Jun-04 - Dec-05)  
km/h

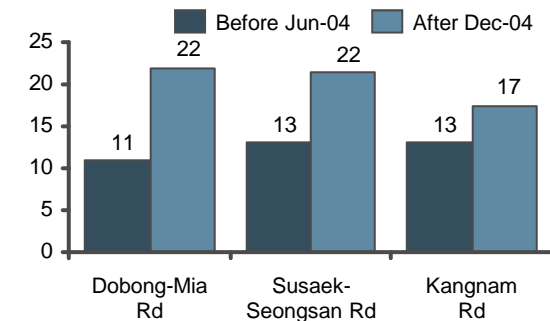



## Agenda

---

	<i>Page ref.</i>
● Executive summary	4
● Evaluation framework for the ABS study	15
● Review of current bus solution	26
● Summary of priority initiatives	48
● <b>Outline of ABS options assessed</b>	
- <b>Overview of ABS options developed</b>	<b>72</b>
- Demand-capacity analysis	186
● Assessment of ABS options	197
● Next steps	210

# A number of the key enablers of an ABS have been established and/or are being put in place

---

## A Public Transport Plan

---

- ✓ The *Regional Public Transport Plan* was released in 2015
- ✓ A hierarchical, rationalised public transport network has been approved and is in deployment

## Deployment

---

- ✓ A regulated environment was re-established through the *Land Transport Management Amendment Act 2013*, allowing AT Metro to shape the network
- ✓ Public Transport Operating Module (PTOM) and the contracting framework was agreed with the industry sector, providing structure for specification, quality, monitoring and control
- ✓ By 2018, it is expected that all bus services in Auckland will be under the new contracting framework
- ✓ The new PTOM contracts are partnering contracts, which are gross cost contracts plus incentives. With the mandatory Financial Incentive Mechanism, operators share some patronage and revenue risk
- ✓ The contracts provide for significant change of scope and scale, facilitating transformative projects

## Operations

---

- ✓ AT HOP cards are held by c.90% of public transport passengers, coming close to achieving cashless travel
- ✓ High capacity, high quality buses (i.e. double-deckers) are being deployed and have been well received by users
- ✓ AT Metro plans to establish a comprehensive public transport Operations Control Centre

## Two ABS options were developed for further assessment (1 of 2)

### AART

### AART+

- The 'Auckland CBD – Airport Rapid Transit' (AART) option comprises three different types of service along the Dominion Rd corridor:
  - an 'all stops' service every four minutes (15 services per hour) from Mt Roskill Junction to Mt Roskill Junction via Britomart
  - an 'all stops' service every four minutes from the Airport to Airport via Britomart
  - two 'express' services every four minutes from the Airport to Airport via Britomart, only stopping at the express ABS stations
- Seven express ABS stations have been chosen, i.e. Britomart, Aotea Square, Karangahape Rd, Mt Roskill Junction, Onehunga Rail Station, Airport Business District and the Airport
- Key characteristics of the AART option include:
  - a public transport mall on Queen St from Customs St to Mayoral Dr
  - the use of median and parallel offset median stations along Dominion Rd (located at major traffic signal controlled intersections that allow for pedestrian access)
  - the use of median dedicated rights of way
  - the use of 18m articulated, specialised ABS vehicles (100 persons per vehicle; 60 seated and 40 standing) for 'all stops' services and double-decker ABS vehicles (100 persons per vehicle; 85 seated and 15 standing) for 'express' services
  - the use of hybrid vehicles at a minimum, with a gradual transition to all electric vehicles
  - off-board ticketing

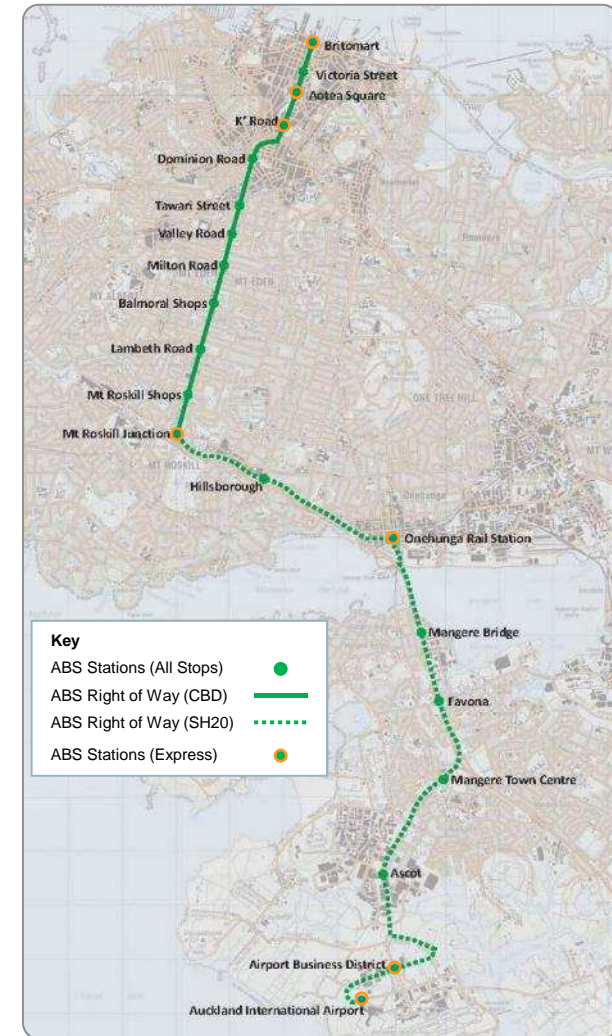

## Two ABS options were developed for further assessment (2 of 2)

AART

AART+

- The 'Auckland CBD – Airport Rapid Transit Plus' (AART+) option comprises five different services along the Dominion Rd and Manukau Rd corridors:
  - an 'all stops' service every four minutes (15 services per hour) from Mt Roskill Junction to Mt Roskill Junction via Britomart along Dominion Rd
  - an 'all stops' service every four minutes from the Airport to Airport via Britomart along Dominion Rd
  - an 'all stops' service every eight minutes (7.5 services per hour) from the Airport to Airport via Britomart along Manukau Rd
  - an 'express' service every four minutes from the Airport to Airport via Britomart along Dominion Rd, only stopping at the express ABS stations
  - an 'express' service every eight minutes from the Airport to Airport via Britomart along Manukau Rd, only stopping at the express ABS stations
- Eight express ABS stations have been chosen, i.e. Britomart, Aotea Square, Karangahape Rd, Mt Roskill Junction, Newmarket Rail Station, Onehunga Rail Station, Airport Business District and the Airport
- Key characteristics of the AART+ option include:
  - a public transport mall on Queen St from Customs St to Mayoral Dr
  - the use of kerbside and lateral offset median stations along Dominion Rd and Manukau Rd (located at major traffic signal controlled intersections that allow for pedestrian access)
  - the use of median dedicated right of way on Dominion Rd and kerbside ROW on Manukau Rd
  - the use of 18m articulated, specialised ABS vehicles (100 persons per vehicle; 60 seated and 40 standing) for 'all stops' services along Dominion Rd and double-decker ABS vehicles (100 persons per vehicle; 85 seated and 15 standing) for 'all stops' services along Manukau Rd and all 'express' services
  - the use of hybrid vehicles at a minimum, with a gradual transition to all electric vehicles
  - off-board ticketing

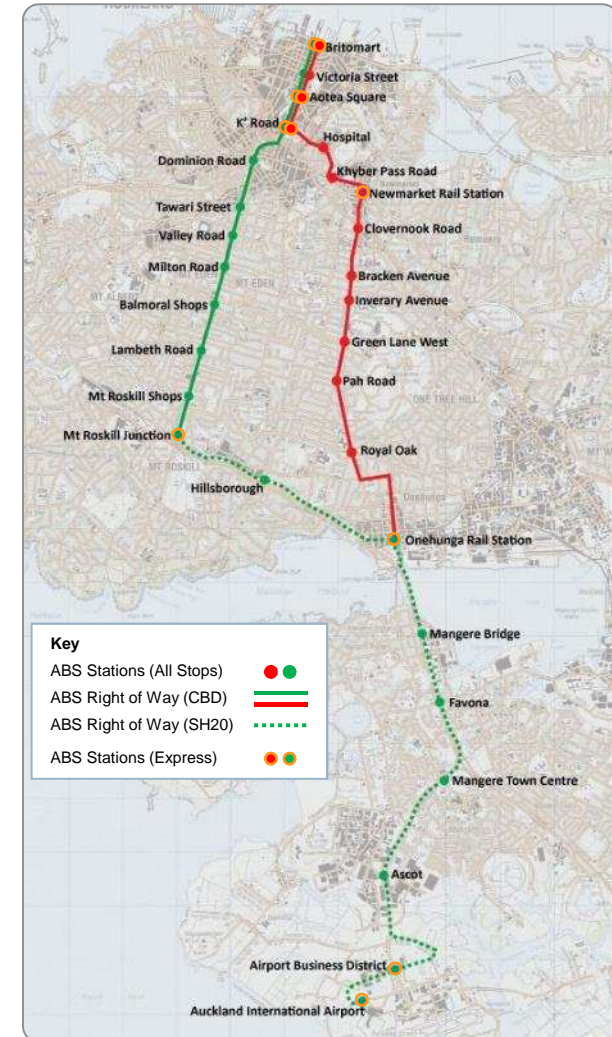

## Each ABS option was developed with 14 key design principles in mind

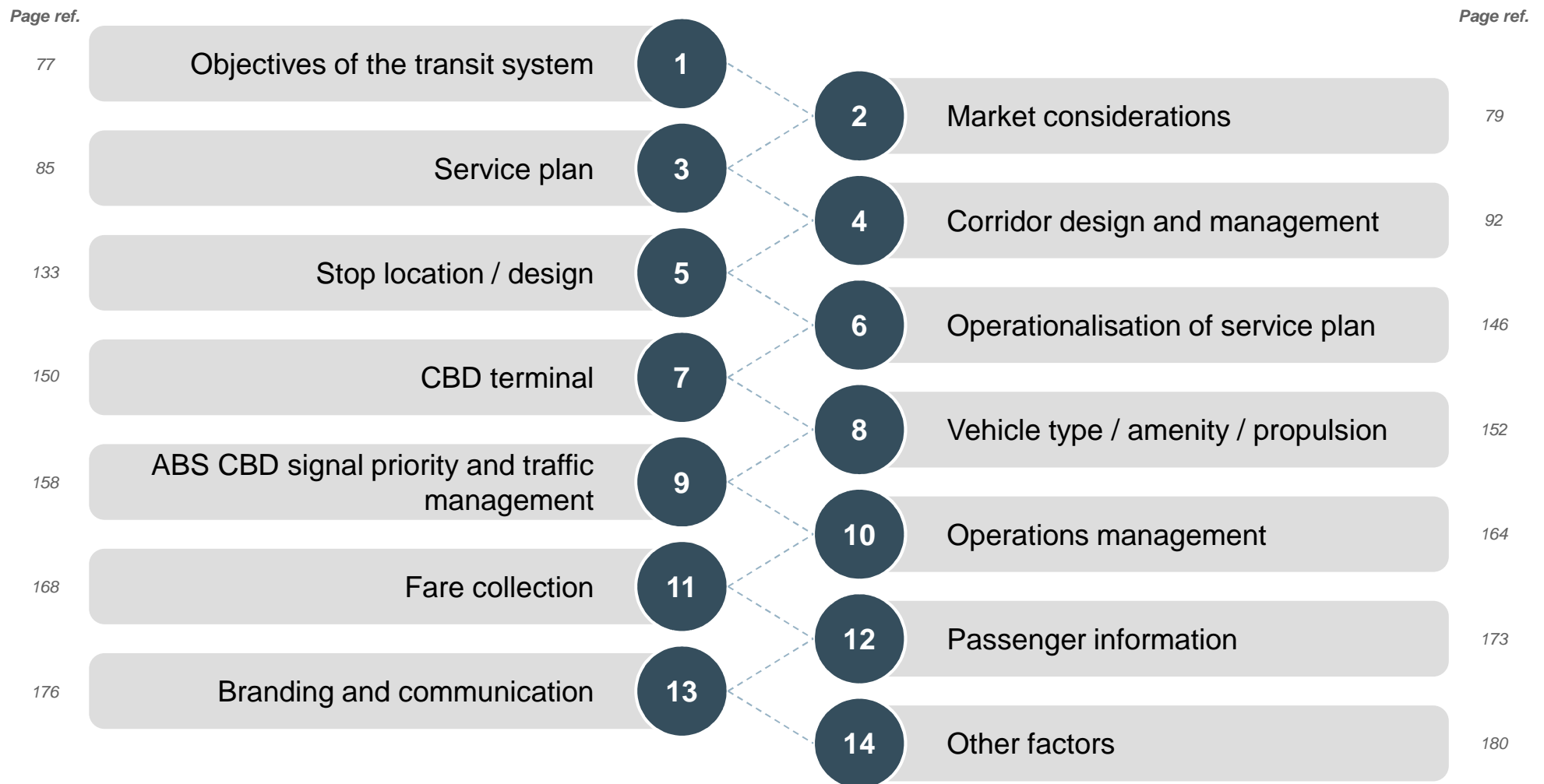

*The key ABS design principles have been packaged to provide a series of feasible variations to future operational service plans as part of a further update to this ABS study*

## Walkthrough of the 14 key design principles

---

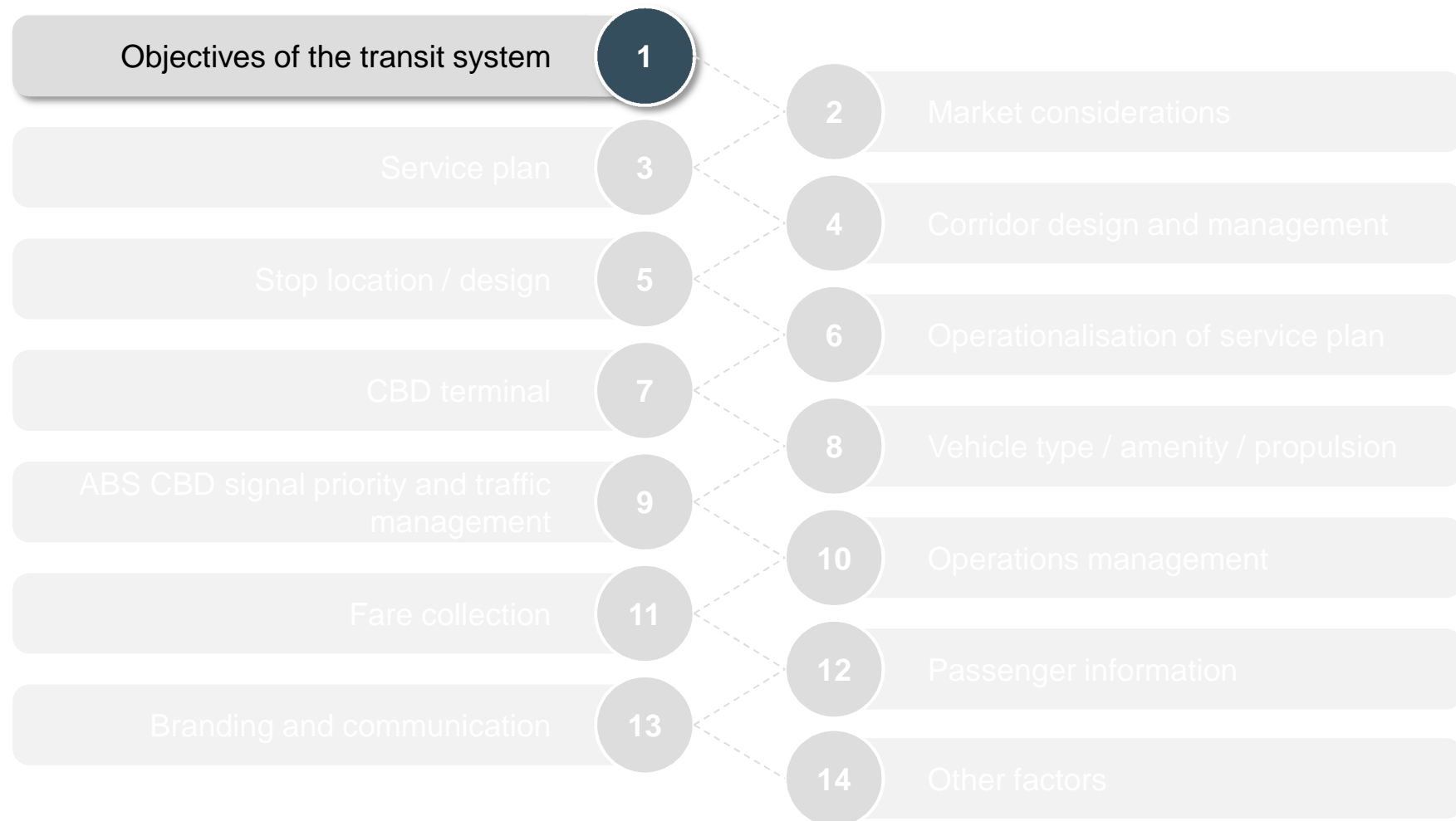

# The objectives of both AART and AART+ should be aligned with those of the Regional Public Transport Plan

1

Objectives of the transit system

## AART

## AART+

- As outlined by the *Regional Public Transport Plan*, the future vision for public transport in Auckland is:  
***an integrated, efficient and effective public transport network that caters for a wider range of trips and is valued by Aucklanders***
- The objectives of the ABS should be aligned with those of the *Regional Public Transport Plan*, including:
  - a permanent network of connected frequent services that supports Auckland's future growth
  - simple, integrated services that connect people with where they want to go
  - a high standard of public transport infrastructure that supports service provision and enhances the customer experience
  - a convenient and reliable public transport system using modern vehicles
  - a fares and ticketing system that attracts and retains customers, while balancing user contributions against public funding
  - simple, visible and intuitive customer information and service
  - improved access for communities and groups whose needs are not met by the regular public transport system
  - a procurement system that supports the efficient delivery of public transport services
  - effective and efficient allocation of public transport funding
  - a system of monitoring and review that supports continuous improvement

## Walkthrough of the 14 key design principles

---





# A series of market considerations were reflected in the development of potential ABS options (1 of 5)

## AART

## AART+

### Target markets

- As highlighted in the SMART study, it is important that the ABS not only serves visitors to Auckland, but also serves commuters that work at the Airport and in the surrounding areas of employment
  - Auckland Airport plays a significant role in NZ's tourism industry and currently serves over 120 international and 300 domestic flights each day, generating c.14.5m airline passengers p.a., which is forecast to increase to c.40m passengers p.a. over the next 30 years
  - of the total airline passengers, c.16% of the international passengers and c.22% of the domestic passengers travel directly to the city centre from the Airport
  - of the total work related airline passengers, c.23% of the international passengers and c.26% of the domestic passengers travel directly to the city centre from the Airport
  - the Airport and surrounding businesses have become a significant employment hub, with c.20,000 employees across c.900 businesses
  - The Auckland Airport Master Plan* aims to increase employment to 27,000 jobs within the next 30 years, making south-west Auckland one of the largest employment hubs in Auckland
- In line with the CAP study, the ABS will also focus on commuters to the city centre along the isthmus, particularly those that intend to access the city centre for employment, education and tourism
  - there were c.84,000 people working in the city centre in 2013; this is forecast to increase to c.156,000 by 2046
  - in the same year, there were c.68,000 people in the city centre for educational purposes; this is forecast to increase to c.83,000 by 2046
- Findings from the *Auckland Transport Market Perception Report*, which categorised the people of Auckland by their public transport usage, suggest that a well designed, attractive ABS option will improve the perception of frequency and reliability associated with public transport and likely shift the 20% of Aucklanders in the 'occasional' but positive public transport users category towards the 'frequent' public transport users category (only 15% of Aucklanders)

		How often do you use public transport?			
		Never / virtually never	Occasionally (less than monthly)	Medium (monthly to weekly)	Frequently (two days per week or more)
Which describes your preference?	Would you like to use public transport less / only use public transport if I have to	35% (rejecter)	5% (new and occasional at risk)	1% (medium at risk)	1% (regular at risk)
	Happy with my use of public transport		10% (new and occasional)	5% (medium)	9% (regular)
	Would like to use public transport more	14% (consider)	10% (new and occasional – opportunity)	4% (medium – opportunity)	5% (regular – opportunity)

*Auckland Transport Market Perception Report: Bus adoption, identification questions*

# A series of market considerations were reflected in the development of potential ABS options (2 of 5)

## AART

## AART+

### Key O-D patterns

- As discussed in the SMART study, the strong travel, freight, employment and population projections for the Airport and within the study area indicate a significant increase in travel demand to the Airport in the future
  - the daily commuter origin-destination patterns for the Airport and surrounding businesses were **8,720 trips from the east and south** (Manukau, Papakura and South Auckland) and **6,140 trips from the west and north** (West Auckland, North Shore and City)
- Because of the high expected volume of commuters to the Airport and surrounding areas, providing effective public transport links along this route between south-west Auckland, surrounding areas and the city centre would provide better access to the employment opportunities available
- According to the *Journey to Work Patterns in the Auckland Region* report, the city centre / CBD accounted for **c.14% of all commuting destinations** with the 'Other Central' sector accounting for c.9%, while the city centre / CBD and the 'Other Central' sectors accounted for c.3% and c.4% of commuting origins, respectively
- The *Journey to Work Patterns in the Auckland Region* report also stated that trips by private vehicles accounted for **c.75% of all commuting trips in Auckland**, while c.6% travelled by bus, c.2% by train, c.6% by walking / cycling and c.8% worked at home. The ABS aims to induce demand from private vehicle trips onto public transport for these commuting trips in Auckland

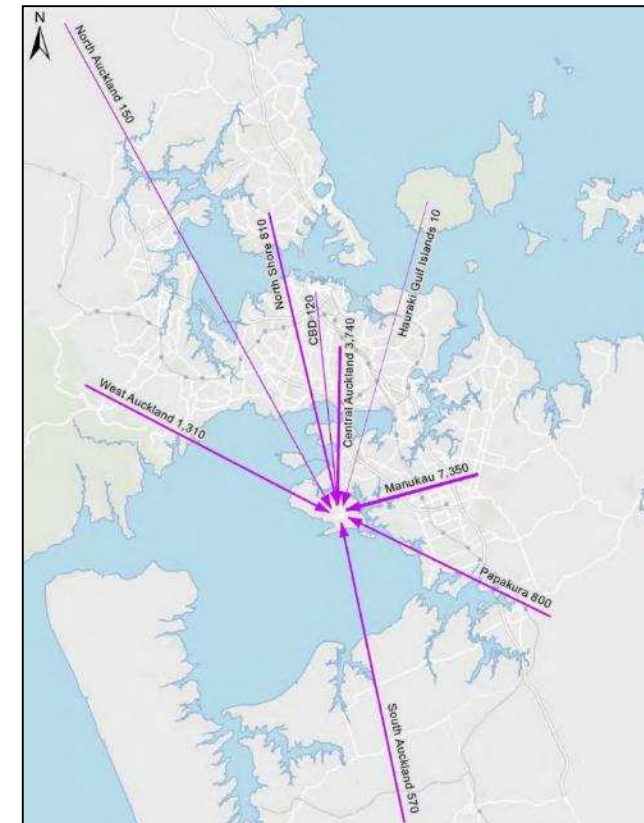

Daily commuter origin-destination patterns for the Airport and surrounding businesses

# A series of market considerations were reflected in the development of potential ABS options (3 of 5)

## AART

## AART+

**Projected peak traffic demand**

- There are c.62,500 vehicles each day moving to/from the Airport using SH20A/B, and this is expected to more than double by 2041
  - modelling of volume to capacity ratios suggest that congestion issues will be experienced on most of Auckland's motorway network, indicating that road improvements will not provide sufficient capacity
- Public transport to the Airport and surrounding areas is limited
  - the nearest rail services terminate in Onehunga and only one bus route serves the Airport and surrounding employment areas, which will run every 15 minutes as part of the New Network
  - improved public transport will provide congestion relief by inducing greater public transport patronage, thereby freeing up capacity on the road network in this area
- Demand for peak bus access to the city centre is forecast to double from 2016 to 2046
  - along Dominion Rd, the morning peak inbound bus patronage has grown by c.6.7% p.a. over the last five years
- The CAP study focused on corridors from the isthmus that feed into the city centre. The most critical corridors are those converging on Symonds St. There are various initiatives planned to manage this increased demand and the CAP Programme Business Case Update (June 2016) recommended a mass transit facility that would provide a 'step change' capacity increase on an underutilised city centre corridor

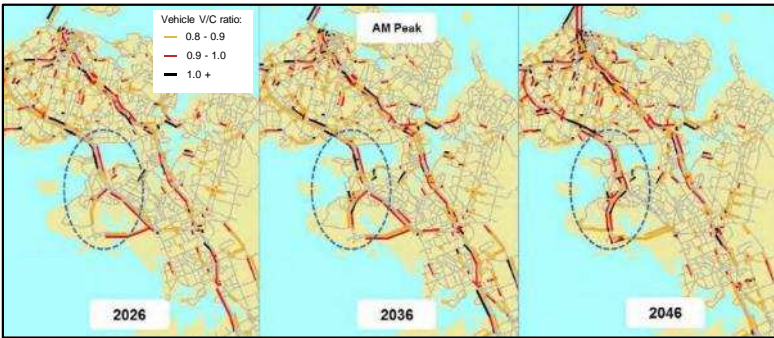

Volume-capacity ratio on the road network after upgrades (AM peak)

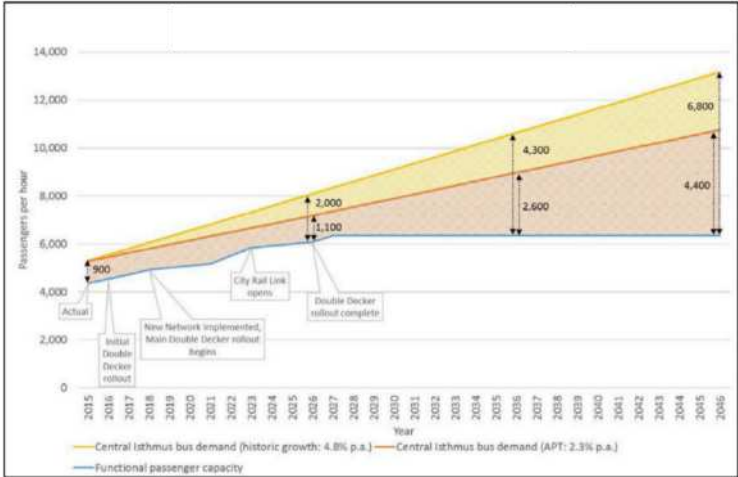

Symonds St Bus Capacity and Demand

Source: Auckland Transport Alignment Project; Auckland Transport SMART Business Case; CAP programme business case

# A series of market considerations were reflected in the development of potential ABS options (4 of 5)

## AART

## AART+

### Reducing the peak to off-peak ratio

- Transport systems are often defined for the peak periods, driven by education and work travel; a reduced system is provided for those that travel during the rest of the day or on weekends. The ABS aims to provide for those customers that may have been underserved in the past, in line with the all day services provided as part of the New Network
- There is a sharp peak to off-peak ratio in Auckland, and encouraging passengers to travel in the shoulder periods will make a considerable impact on demand. This will be encouraged by providing reliable and frequent ABS services all day
- As an example, Singapore previously implemented a scheme to motivate peak-period mass transit commuters to travel earlier into the city, providing 'free pre-peak travel' in June 2013. Commuters who end their train journey before 7.45am on weekdays at 18 designated stations in the city area get to travel free, while commuters who exit between 7.45am and 8.00am enjoy up to 50 cents discount off their fares
- The results were encouraging as c.7% of peak hour travellers moved out of peak hour travel (8-9am). This resulted in a more even distribution of morning peak hour crowds, which meant that all commuters benefited from less crowded transit
- The provision of ABS services in what is considered the 'off-peak' is important for those that work at the Airport and surrounds
  - shift work is common in the south-west Auckland area as a large proportion of employment opportunities relate to hospitality, transport / logistics, industrial and manufacturing. As part of a survey conducted by Qrious between February and May 2015, it was found that a large number of employees arrive at the Airport early during the day and late during the evening

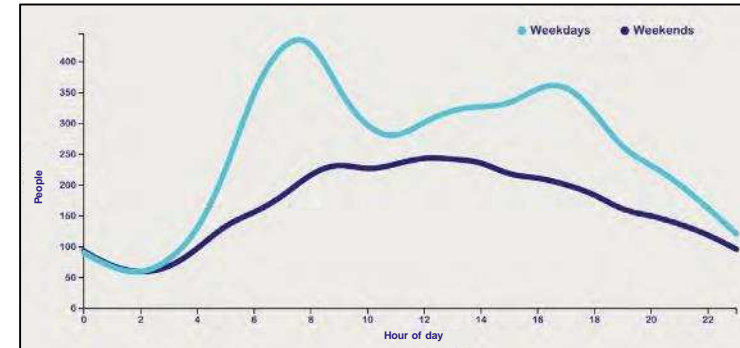

The average number of Airport workers arriving by hour\*



Peak station crowding can reduce customer satisfaction

Note: \* Auckland Airport Traffic Analysis data obtained for February-May 2015  
Source: Auckland Transport SMART Business Case; Qrious

# A series of market considerations were reflected in the development of potential ABS options (5 of 5)

## AART

## AART+

### *Development of ridership along the corridors*

- Ridership development is a critical step in the development planning of a new transit route or change in service. Very often, when a new transit route is introduced, the existing routes will be need to be modified, vehicle capacities changed or service headways adjusted. This has made ridership development for the new, existing, and modified routes challenging
- The development of demand is often linked to the branding and communication of the proposed new market or route and the improved information related to the amendments to the other services. Once this has been established and the customers are informed, then it is the operational and reliability targets that will maintain and raise the passenger demand on the basis that the route provides the critical levels of service that meets the customer expectations
- Transporting people from an origin to a destination at the end of a corridor is generally considered to be the critical issue; however, corridors are ecosystems in themselves and there is a market for trips that can be served along the corridors as part of the ABS
  - this is especially pertinent for travel within the Queen St, Dominion Rd and Manukau Rd corridors for access to Britomart, Aotea, Karangahape Rd, Newmarket, Mt Roskill, Onehunga, Epsom and other village centres along these corridors where a frequent, reliable service is provided by the ABS
  - although considerable focus is placed on providing rapid transit to the Airport to serve visitors to Auckland, it is known that the majority of patronage would be made up of commuters that will travel from within the ABS corridors into Mangere South and to the Airport and surrounding areas for employment purposes

## Walkthrough of the 14 key design principles

---

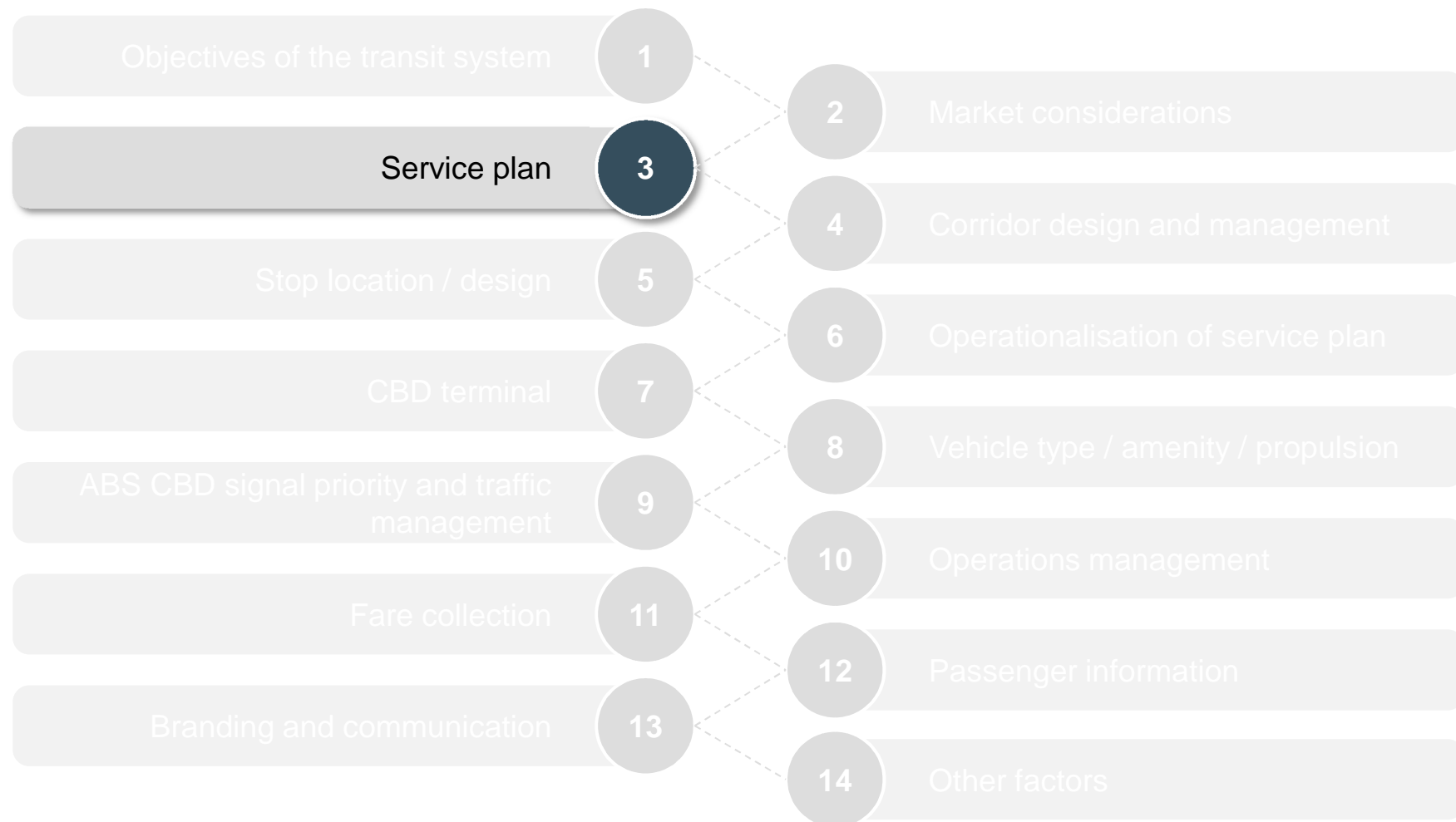

## Four key questions were asked in order to understand the service plan requirements

3

Service plan

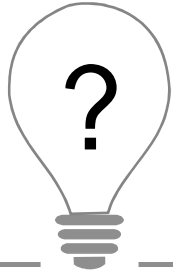

Should only designated ABS routes use dedicated running ways?



Are all ABS routes confined to running only on dedicated running ways or elsewhere as well?



Should we have variations in the stopping patterns (e.g. local, limited stop, express etc.)?



Should we have a designated network of connectors to the ABS / routes?

*The answers to these questions helped guide the **network topology, stopping patterns, frequency, span of service** etc.*

# The strategic principles of the service plan were defined for the purpose of this ABS study

- For the purpose of this ABS study, the strategic principles of service planning were defined for the ABS options considered
- Elements that need to be included in the delivery of the service planning and the long term quality design of the ABS and the CBD New Network bus services include the following:
  - service levels (i.e. frequencies, span of service)
  - route selection for the ABS along the Dominion Rd corridor, additional services routes for express to the Airport (Manukau Rd and Dominion Rd) and the New Network changes required to accommodate these solutions, as well as noting that all services are Airport to Airport via Britomart for the 'all stops' and 'express' services on both the Dominion Rd and Manukau Rd corridors, meaning that there is limited layover or CBD terminal requirements for the ABS
  - ABS station locations for the Dominion Rd corridor are serviced by a Mount Roskill Junction to Mount Roskill Junction via Britomart 'all stops' service and the additional routes for 'express' services to/from the Airport (via Manukau Rd and Dominion Rd)
  - bus stop locations for the New Network bus routes (AT has advised the changes required to the New Network to suit the requirements of the ABS)
  - dedicated right of way and mixed operations sections on the routes for Dominion Rd and Manukau Rd
  - intersection improvements and 'Traffic Signal Priority' proposals
  - station design and operational information related to boarding and alighting times
  - fare collection proposals for the proposed open system and all ticket validation to be within the station and off-board
  - Intelligent Transportation Systems (ITS)
  - communications and branding (this is a 'softer' issue but no less important to the long term viability of the ABS and for public transport in Auckland overall)

***There is considerable amount of iterative work that is required to develop a detailed, operational service plan to deal with the entire public transport network that feeds the Auckland CBD***



# For the purpose of the ABS option development process, the following was derived as the simple service plan (1 of 4)



- For AART, the simple service plan consists of:
  - A** an 18m articulated 'all stops' service every four minutes (15 services per hour) from Mt Roskill Junction to Mt Roskill Junction via Britomart
  - B** an 18m articulated 'all stops' service every four minutes from the Airport to Airport via Britomart
  - C** **D** two double-decker 'express' services every four minutes from the Airport to Airport via Britomart, only stopping at the express ABS stations
- One of the 'express' services is as prescribed, while the second route could be treated as a 'placeholder' for another route to be defined during the next phase of the study in 2017. The placeholder 'express' service could be used as an Airport Express that:
  - continues along the Northern Busway and connects the northern part of Auckland, or
  - connects from Puhinui Rail Station or Manukau City in the south-east, or
  - originates near the Airport (e.g. airport industrial zone or suburbs east of the Airport) and avails of the dedicated running way into Onehunga and the CBD

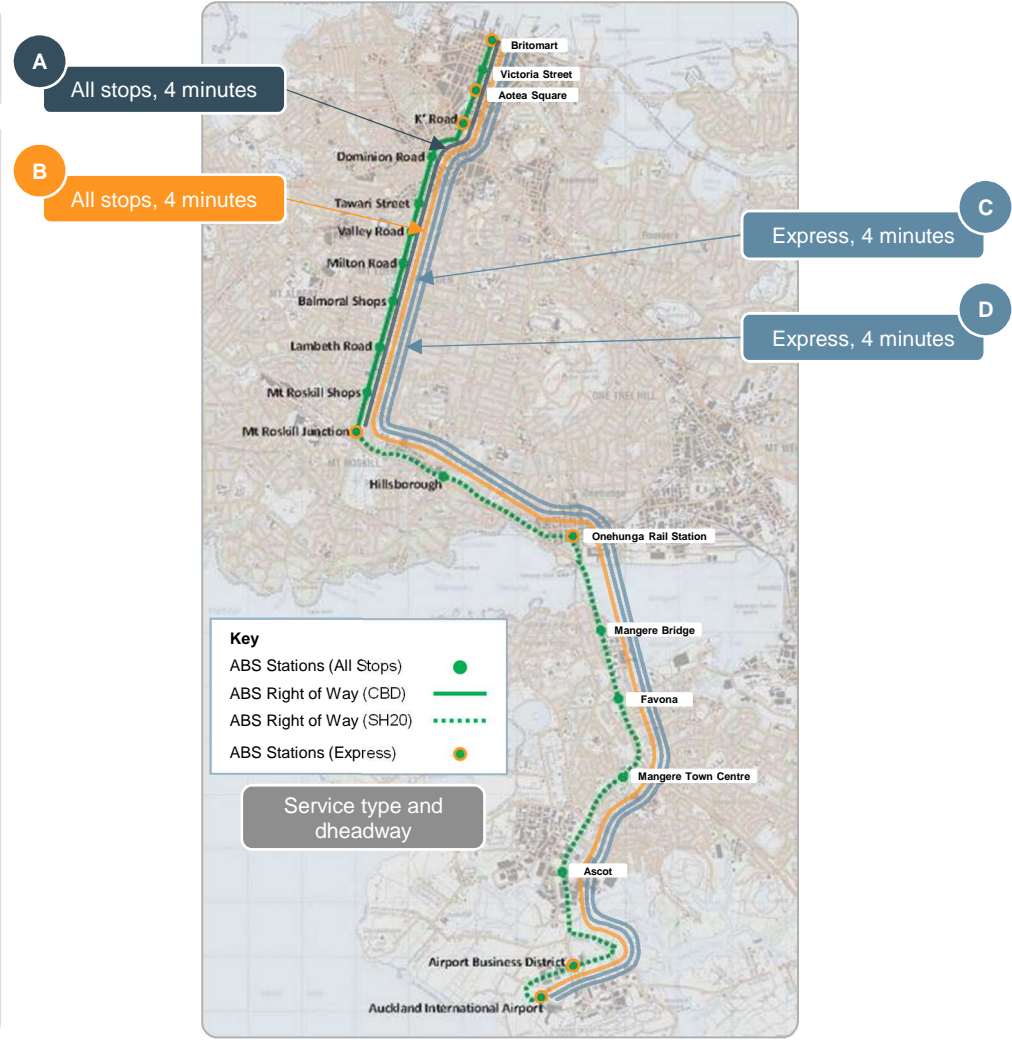

# For the purpose of the ABS option development process, the following was derived as the simple service plan (2 of 4)

## AART

This is not to suggest that a one minute headway needs to be maintained between all ('all stops' and 'express') services along this part of the corridor, because these services can operate together

### Effective corridor headway and service type

- 2 minute 'all stops' (articulated)
- 2 minute 'express' (double-decker)

- 4 minute 'all stops' (articulated)
- 2 minute 'express' (double-decker)

**Key:**  
Dominion Rd corridor

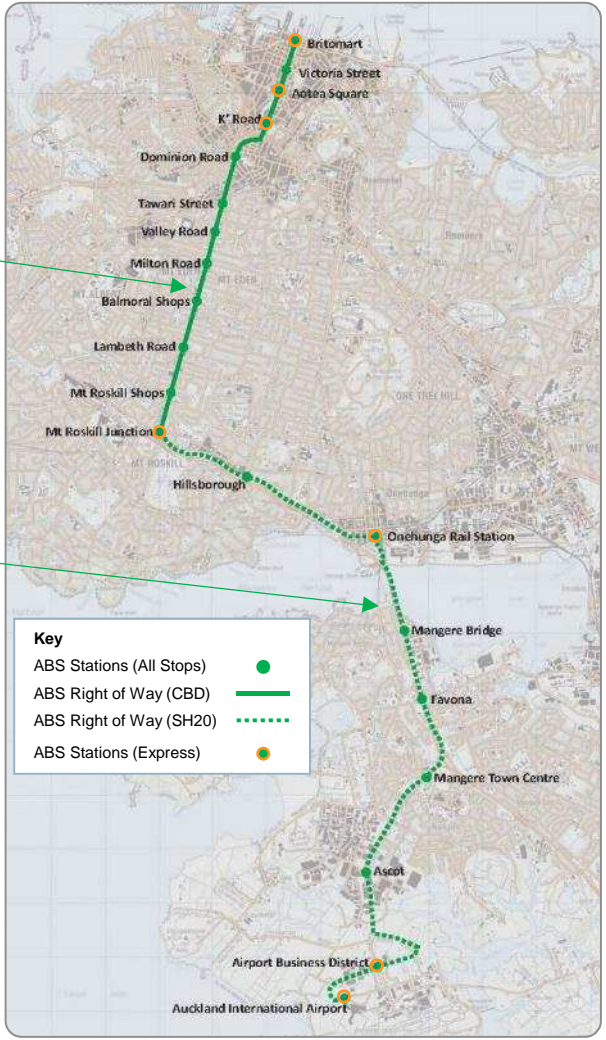

### Peak corridor capacity

60 buses per hour

45 buses per hour

# For the purpose of the ABS option development process, the following was derived as the simple service plan (3 of 4)

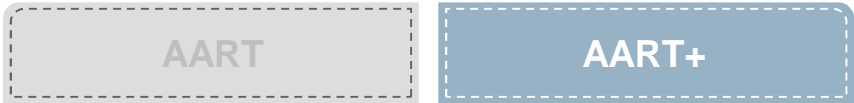

- For AART+, the simple service plan consists of:
  - A** an 18m articulated 'all stops' service every four minutes (15 services per hour) from Mt Roskill Junction to Mt Roskill Junction via Britomart along Dominion Rd
  - B** an 18m articulated 'all stops' service every four minutes from the Airport to Airport via Britomart along Dominion Rd
  - C** a double-decker 'all stops' service every eight minutes (7.5 services per hour) from the Airport to Airport via Britomart along Manukau Rd
  - D** a double-decker 'express' service every four minutes from the Airport to Airport via Britomart along Dominion Rd, only stopping at the express ABS stations
  - E** a double-decker 'express' service every eight minutes from the Airport to Airport via Britomart along Manukau Rd, only stopping at the express ABS stations
- One of the 'express' services is as prescribed, while the second route is a 'placeholder' route to be defined during the next study phase in 2017. The placeholder 'express' service could be an Airport Express that:
  - continues along the Northern Busway and connects the northern part of Auckland, or
  - connects from Puhinui Rail Station or Manukau City in the south-east, or
  - originates near the Airport (e.g. airport industrial zone or suburbs east of the Airport) and avails of the dedicated running way into Onehunga and the CBD

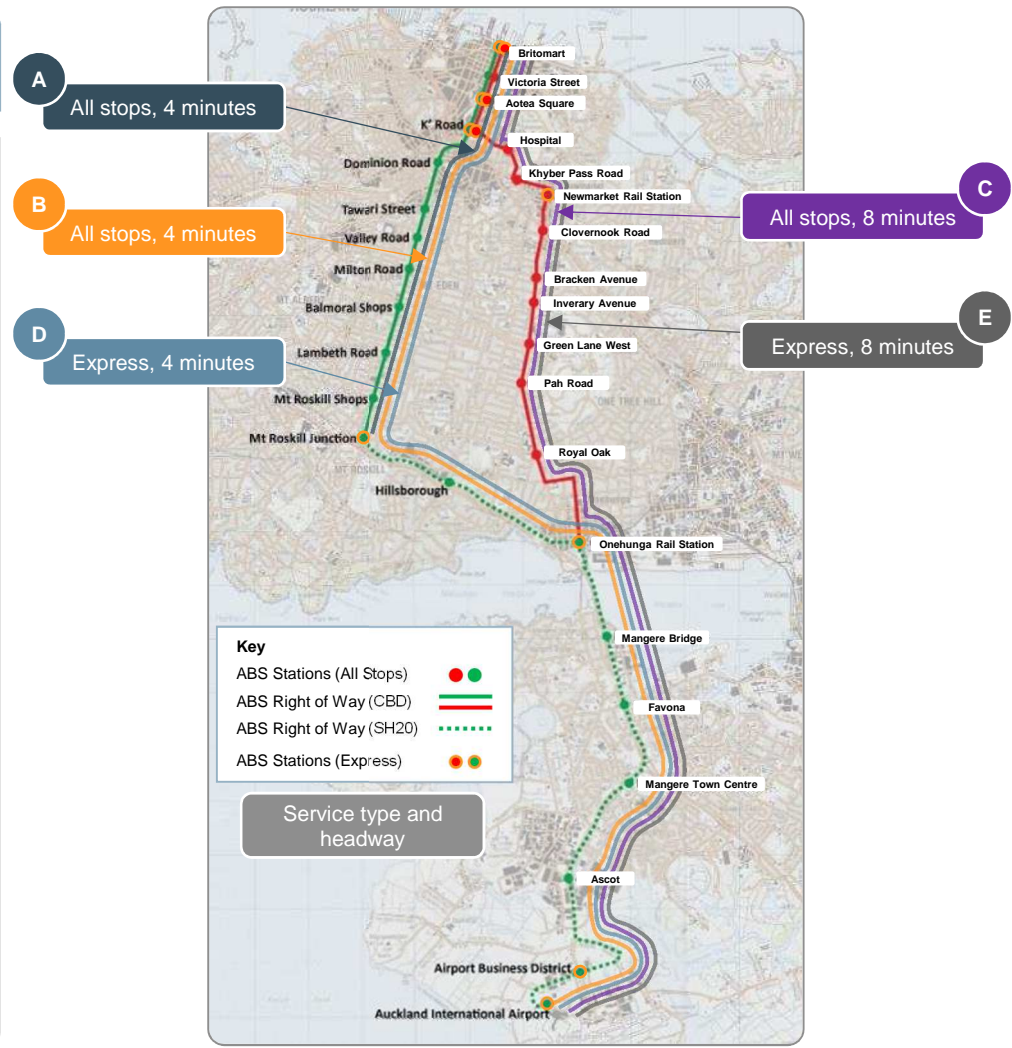

# For the purpose of the ABS option development process, the following was derived as the simple service plan (4 of 4)

While there will need to be 60 buses per hour along the Queen St section, this does not necessarily equate to one minute headways between all ('all stops' and 'express') services, because these services can operate together

Peak corridor capacity	Effective corridor headway and service type
45 buses per hour	<ul style="list-style-type: none"> <li>2 minute 'all stops' (articulated)</li> <li>4 minute 'express' (double-decker)</li> </ul>
30 buses per hour	<ul style="list-style-type: none"> <li>4 minute 'all stops' (articulated)</li> <li>4 minute 'express' (double-decker)</li> </ul>
30 buses per hour	<ul style="list-style-type: none"> <li>4 minute 'all stops' (articulated)</li> <li>4 minute 'express' (double-decker)</li> </ul>

**Key:**

- Dominion Rd corridor
- Manukau Rd corridor

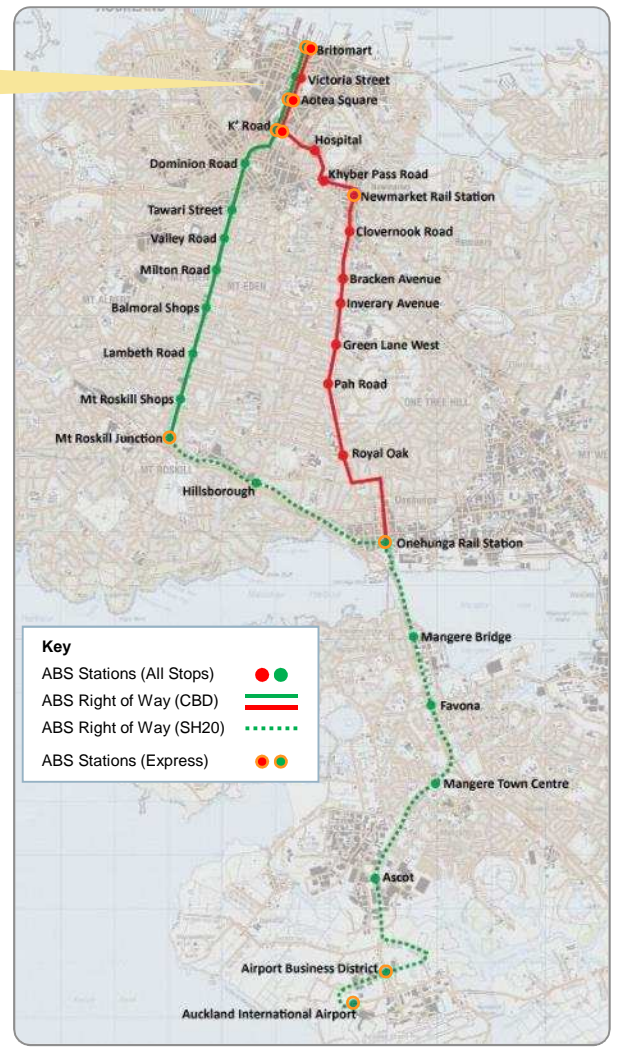

## AART+

Effective corridor headway and service type	Peak corridor capacity
<ul style="list-style-type: none"> <li>8 minute 'all stops' (double-decker)</li> <li>8 minute 'express' (double-decker)</li> </ul>	15 buses per hour
<ul style="list-style-type: none"> <li>8 minute 'all stops' (double-decker)</li> <li>8 minute 'express' (double-decker)</li> </ul>	15 buses per hour

## Walkthrough of the 14 key design principles

---

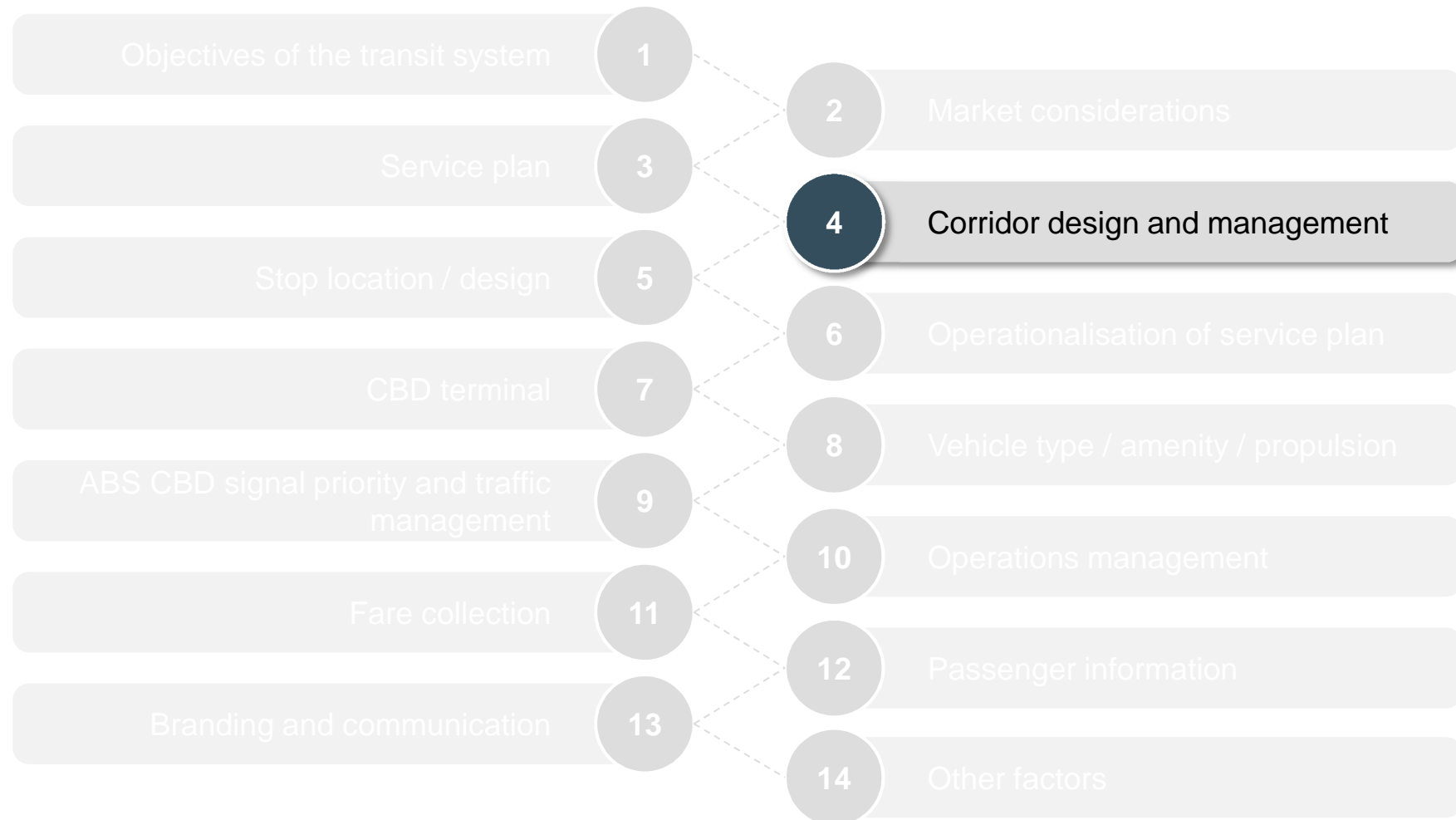

# A number of key criteria were addressed to support the ABS options development

## Single or multiple routes

With competing problem definitions for the CBD and Airport sections of the corridor, a **multiple route option** may also need to be considered

## Dedicated right of way

The use of **dedicated right of way should be maximised**, where possible, while minimising impact to the existing environment

## Cross sections

**Multiple cross sections** should be considered to allow for flexibility through different parts of the corridor

There are a number of options available for **accommodating passing in narrower cross sections**

## Accommodating express services

There should be **no on-street parking in the immediate vicinity of the stations**

## On-street parking

**Park and ride** will be provided at the **outer ends of the corridors** to encourage mode shift and reduce car traffic along the corridor

## Park and ride

# AART provides a single 'CBD to/from Airport' route via Dominion Rd...

## AART

## AART+

*Single or multiple routes*

- AART is an advanced bus solution built on a single route from the CBD to the Airport, i.e.
  - Britomart to Aotea via Queen St, then Upper Queen St to Ian McKinnon Dr, and then onto Dominion Rd to SH20 via Onehunga Rail Station
- As there is no stop in the Queen Elizabeth II Square, there should be a stop at Queen St / Customs St. ABS services will be rerouted via Customs St, Lower Albert St and Quay St to a stop on Commerce St at the rear of Britomart, after which it will right-turn out of Commerce St to Customs St and left-turn into Queen St
- Queen St from Customs St to Mayoral Dr will be a public transport mall and therefore will have public transport, pedestrians, cycles and some limited servicing only (no general traffic)
- The Ian McKinnon Dr section and Dominion Rd will be a dedicated right of way (ROW), with the operation of general traffic alongside the central median ROW and parallel offset median stations
- The SH20 to the Airport link would be an offline busway corridor with a dedicated ROW and central median stations

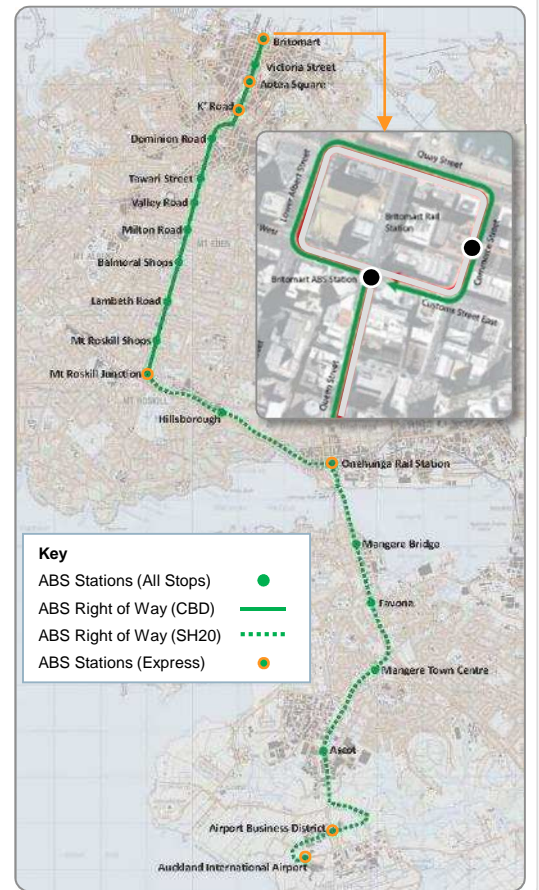

# ... while AART+ consists of multiple 'CBD to/from Airport' routes via Dominion Rd and Manukau Rd

## AART

## AART+

*Single or multiple routes (cont.)*

- AART+ is an advanced bus solution built on two routes from the CBD to the Airport, i.e.
  - Britomart to Aotea via Queen St, then Upper Queen St to Ian McKinnon Dr, and then onto Dominion Rd to SH20 via Onehunga Rail Station
  - Britomart to Aotea via Queen St, then Upper Queen St to Karangahape Rd / Grafton Bridge, Park Rd, Khyber Pass Rd and Broadway, and then onto Manukau Rd to SH20 via Onehunga Rail Station
- The routing of the ABS in the CBD around Britomart will be the same as in the AART option
- Queen St from Customs St to Mayoral Dr will be a public transport mall and therefore will have public transport, pedestrians, cycles and some limited servicing only (no general traffic, and kerbside stations accessing a central right of way)
- The Ian McKinnon Dr section and Dominion Rd will be a dedicated right of way (ROW), with the operation of general traffic alongside the central median ROW and lateral offset median stations
- In the Manukau Rd corridor, with services operating between Britomart and the Airport, there will be localised treatments to develop some critical areas of dedicated ROW with the operation of general traffic alongside the kerbside ROW and kerbside station pairs. The reality is that the 'pinch points' in Manukau Rd will not allow for full dedicated lanes
- The SH20 to the Airport link would be an offline busway corridor with a dedicated ROW and kerbside station pairs

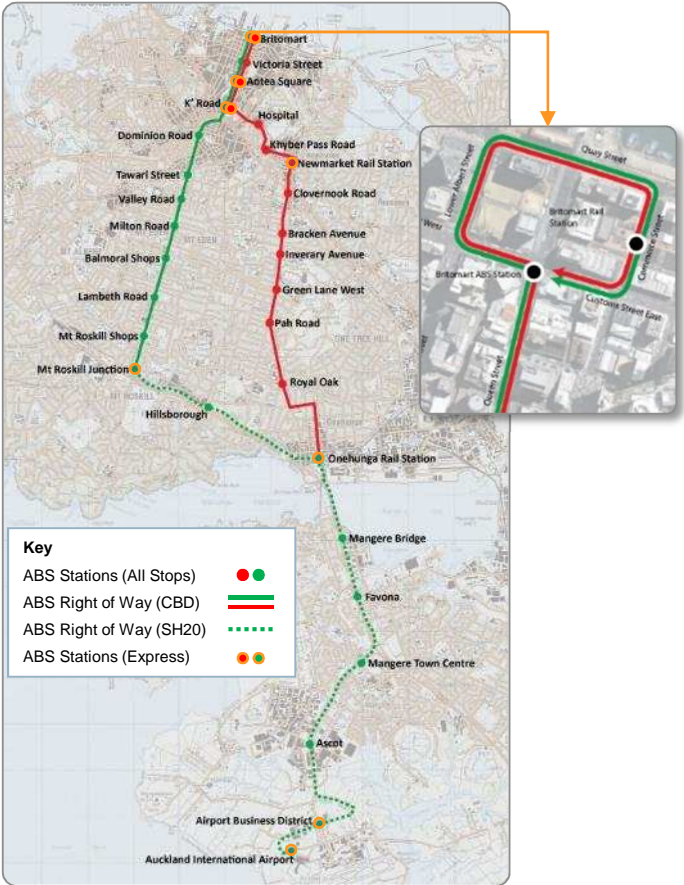



# The use of dedicated right of way should be maximised, where possible, while limiting impact to the existing environment

## AART

## AART+

### Dedicated right of way

- With a dedicated right of way (ROW) and general traffic on the Dominion Rd and Manukau Rd corridors, there may be a need for 'mixed traffic operations' in critical pinch points along the corridors
- The use of either a median ROW or a kerbside ROW would provide certain advantages and disadvantages in relation to:
  - the stations / pedestrian boarding and alighting areas
  - kerbside activity
  - the increased pedestrian activity at crossings with centralised stations
  - the impacts on the corridor turning traffic (left or right turn)
- A series of options are available for providing the right of way for the ABS, ranging from paint markings and hard kerbs to LED road markings, lane control signals and fixed bollards
- From a feasibility perspective, the greater the dedicated ROW, the more reliable the service operations and the higher the patronage and passenger retention will be. As it has often been qualified, brands and beauty may gain the passengers but reliability and function keep them

# For both AART and AART+, a median dedicated right of way will suit different parts of the corridors...

## AART

## AART+

*Dedicated right of way (cont.)*

Typical cross section: Median dedicated right of way including general traffic

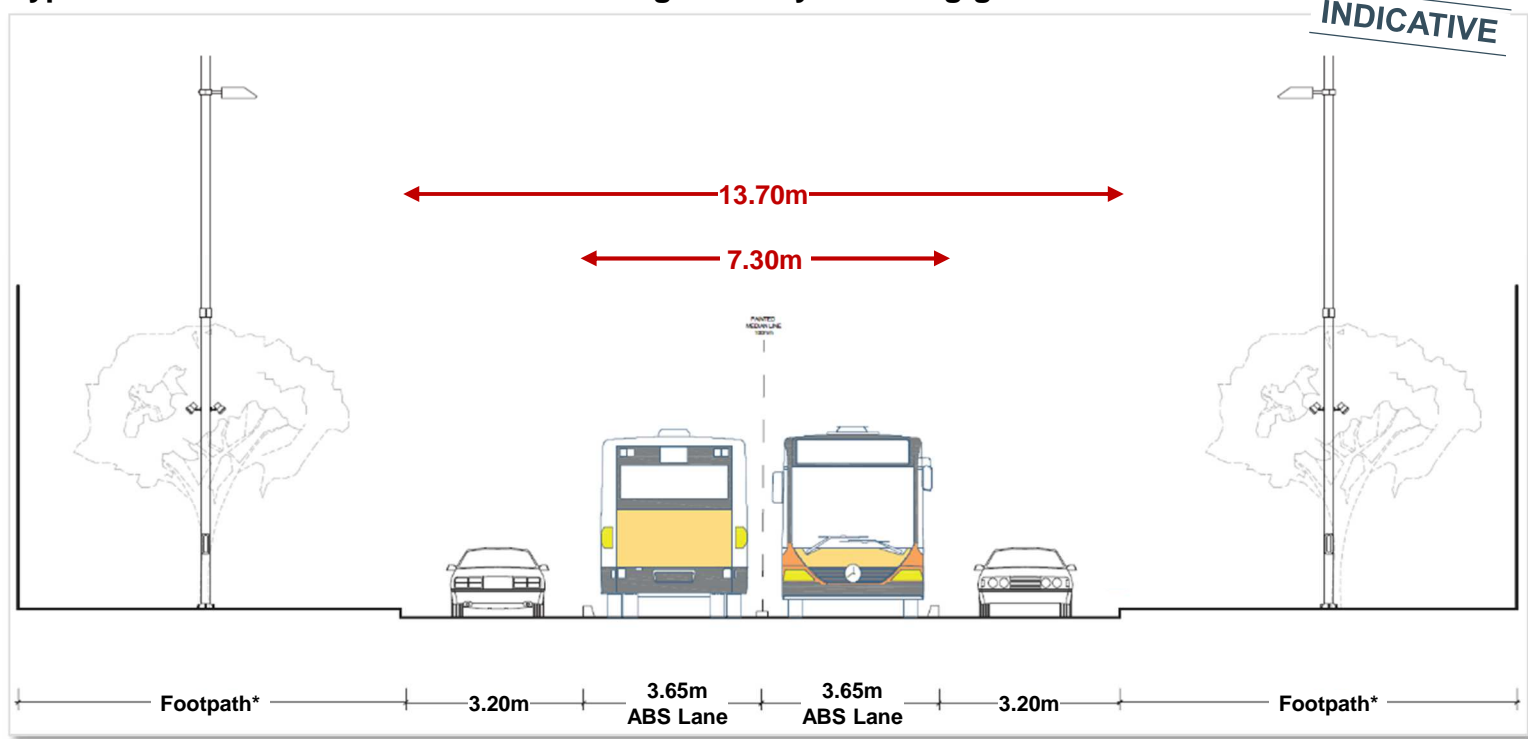

Note: \* This could include cycling facilities, streetscaping / landscaping etc.

# ... while a kerbside dedicated right of way may better suit other parts

## AART

## AART+

**Dedicated right of way (cont.)**

Typical cross section: Kerbside dedicated right of way including general traffic

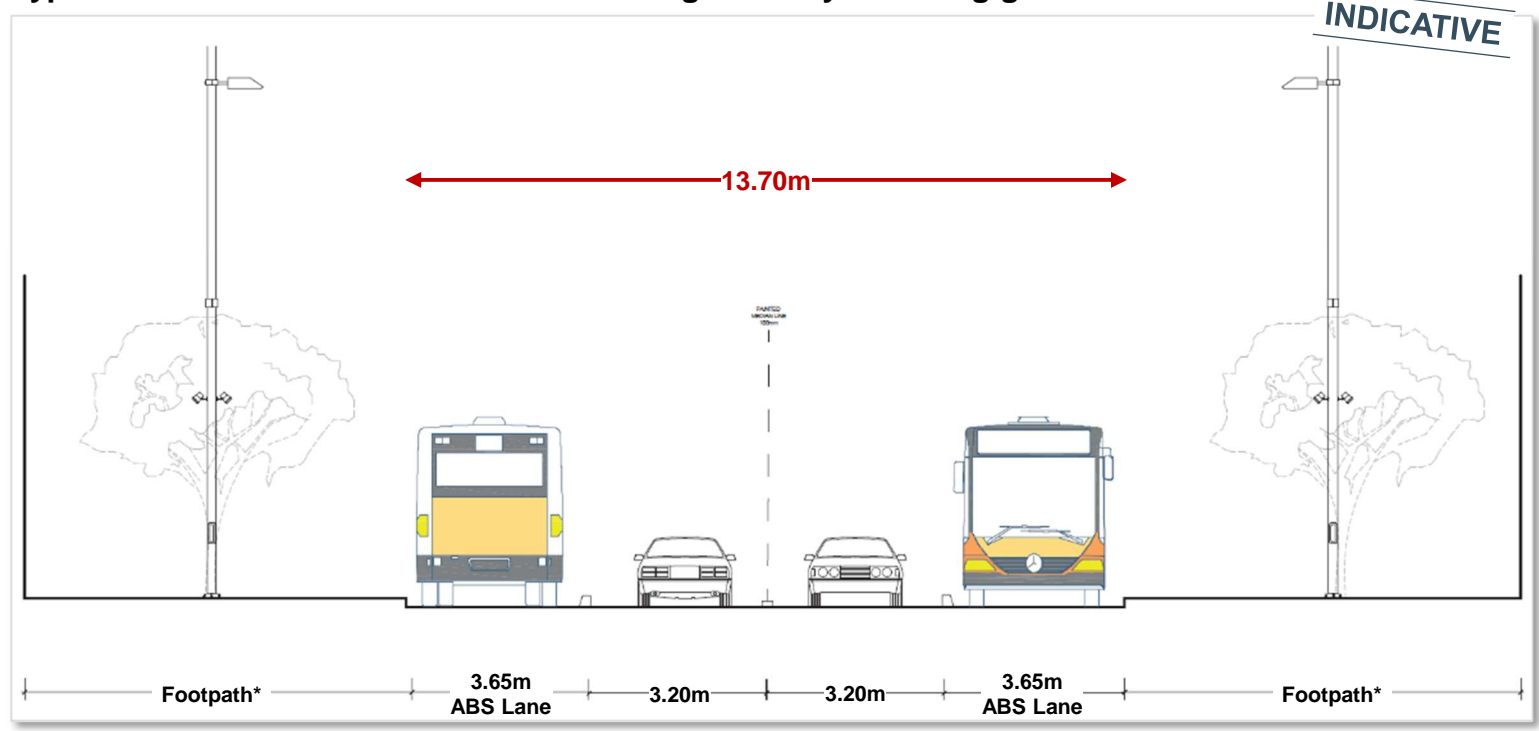

Note: \* This could include cycling facilities, streetscaping / landscaping etc.

# Multiple cross sections were considered to allow for flexibility through different parts of the corridor (1 of 2)

## AART

## AART+

Cross sections

- Multiple cross sections (and station locations / types) were considered to allow for flexibility through different parts of the corridor
  - for AART, the use of a central ROW with a mix of central median and parallel offset median stations is proposed. This will require specialised buses with doors on the right hand side
  - for AART+, the use of both central and kerbside ROW with a mix of kerbside station pairs and lateral offset median stations is proposed. Standard buses with doors on the left hand side can be used
- If a dedicated LRT can be provided through Dominion Rd as part of the previous CAP / SMART reporting, then an ABS can also most definitely be provided in the same corridor. As such the ABS station locations have been broadly aligned with those of the previous studies to aid illustration of the corridor design
- The corridor has been broken down into a series of sections, which have been chosen due to their existing corridor width and their future operational requirements

### Sections for AART

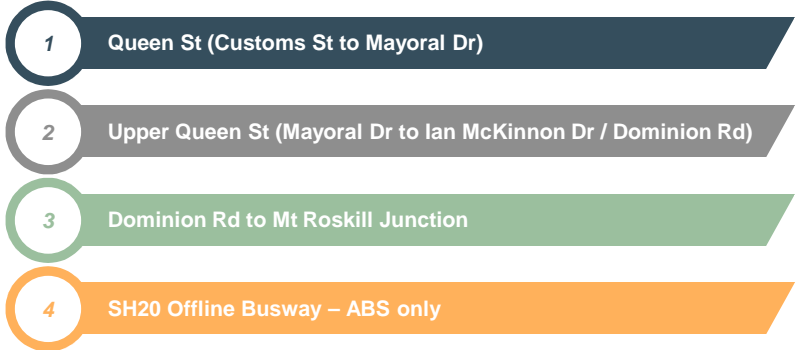

### Sections for AART+

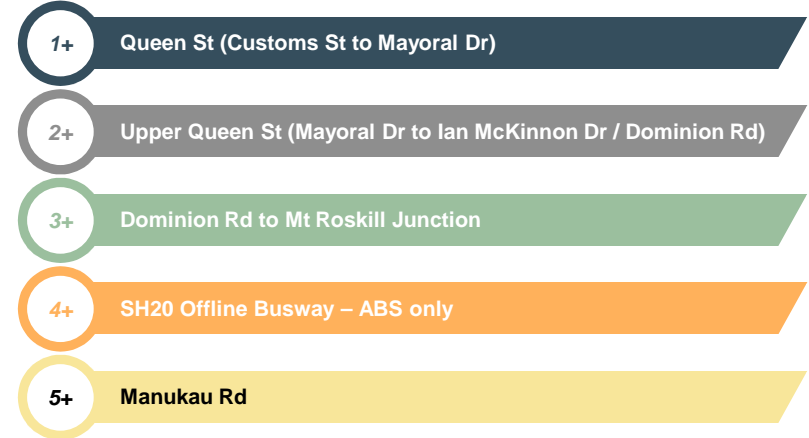

# Multiple cross sections were considered to allow for flexibility through different parts of the corridor (2 of 2)

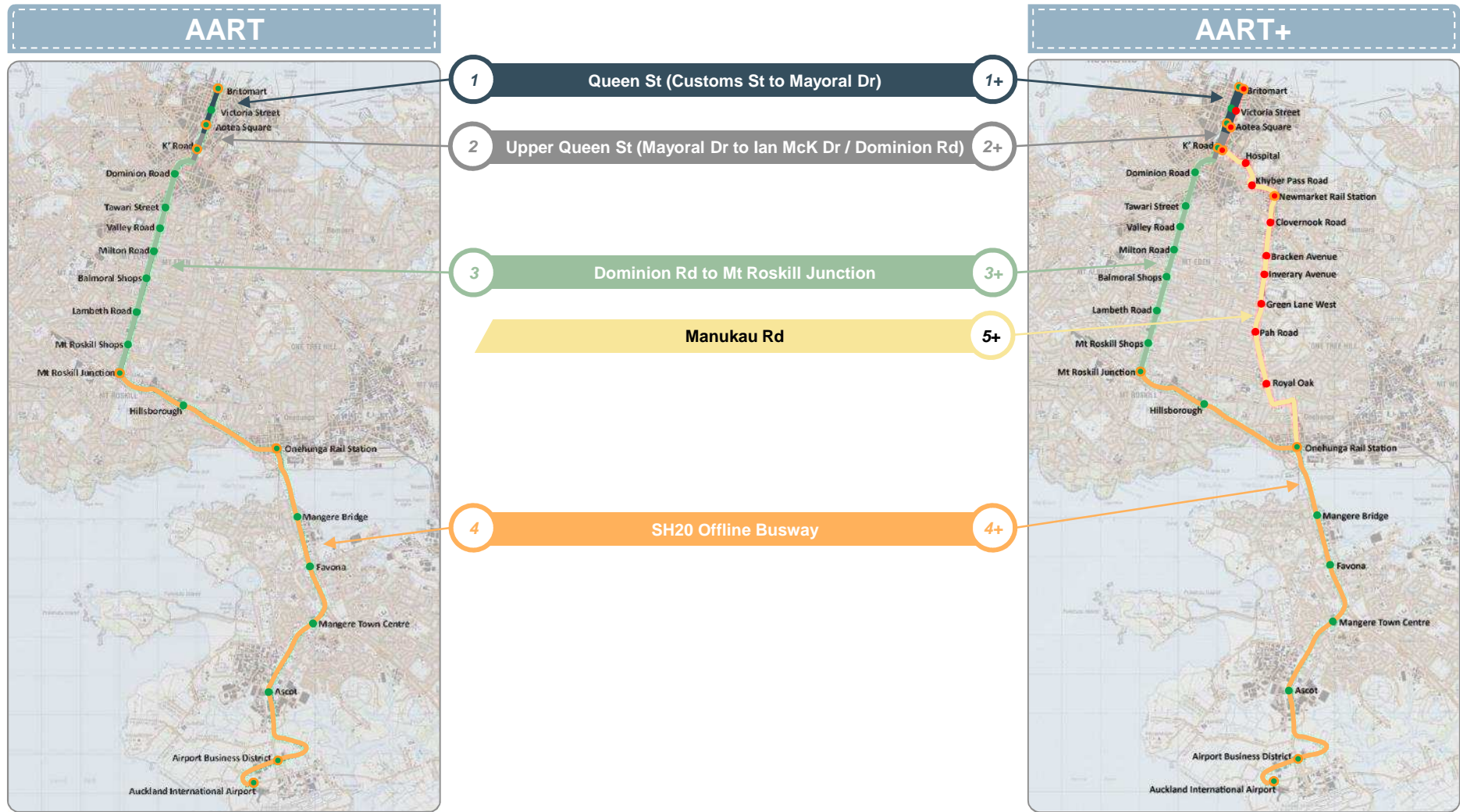

# AART by section

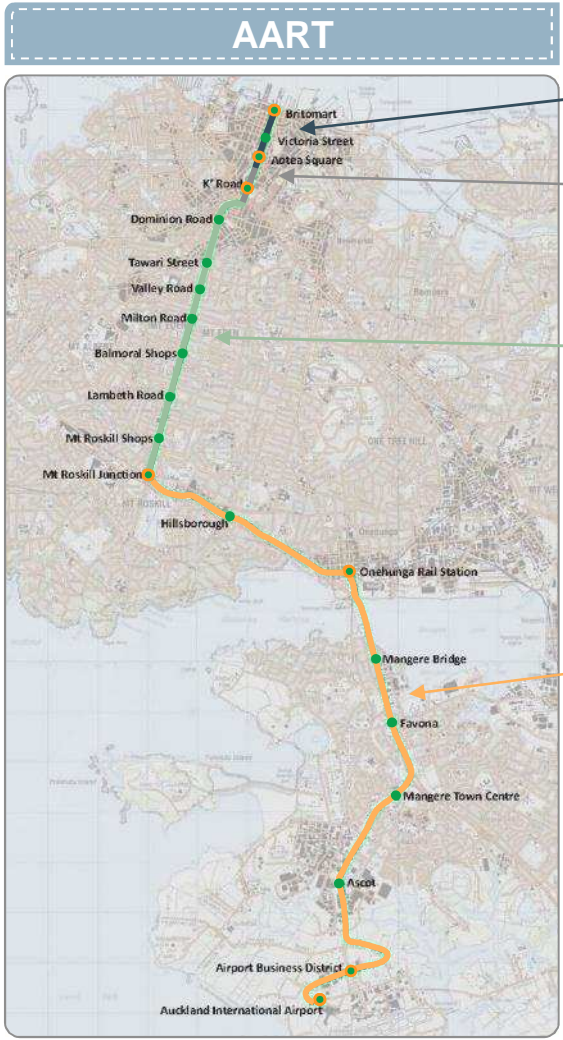

- 1 Queen St (Customs St to Mayoral Dr)
- 2 Upper Queen St (Mayoral Dr to Ian McK Dr / Dominion Rd)
- 3 Dominion Rd to Mt Roskill Junction
- 4 SH20 Offline Busway

ROW	Stations
Fully dedicated, central	Central median
Central	Parallel offset median
Central	Parallel offset median
Fully dedicated, central	Central median

# AART will provide a PT Mall along the lower Queen St section with dedicated ABS lanes throughout

## AART

## AART+

### Cross sections (cont.)

#### 1 Queen St (Customs St to Mayoral Dr)

##### At locations without ABS stations

- The Queen St corridor between Customs St and Mayoral Dr has a relatively consistent width up to the Civic Centre of between 11.5m and 13.5m (close to the Mayoral Dr intersection). Outside the Civic Centre and the St James Theatre, the corridor is widened to allow for the existing bus bays, at which point the kerb to kerb width is approximately 19.0m
- There are large variations in the building to building space in this corridor of between 37.0m (at the Civic Centre) and 24.4m (between Customs St and Fort Lane)
- For the design of AART, it is proposed that the right of way is established throughout this corridor and at each of the intersections along the corridor. In this instance, the preferred minimum width for the ABS is 7.3m. This could be increased to 7.5m if it was deemed necessary to have any raised kerbs between the parallel ABS lanes. However, given the area will be designated as a 'Public Transport Mall' (PT Mall), with only the ABS vehicles, pedestrians, cyclists and the occasional vehicle for servicing of the buildings (accessing via a shared surface facility), the speed in this section of the corridor is expected to be well below 30km/hr and could well be posted and enforced at between 20km/hr and 30 km/hr

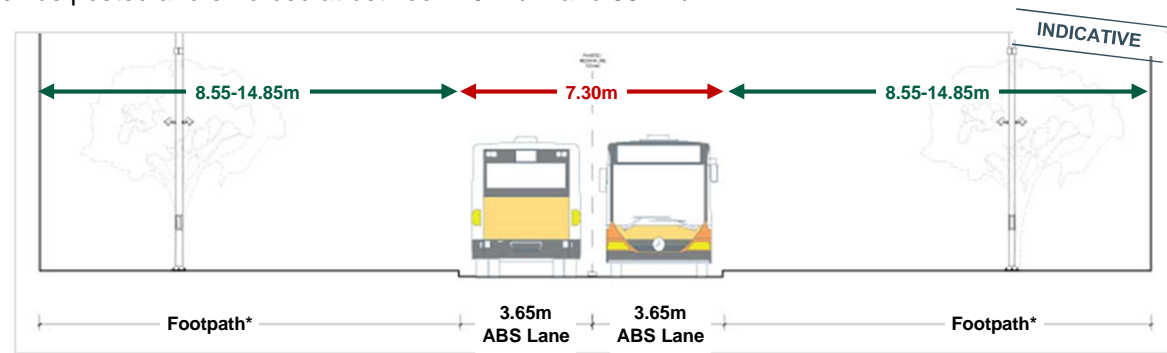

Note: \* This could include cycling facilities, streetscaping / landscaping etc.

# Central median stations will be used in the Lower Queen St section of AART

## AART

## AART+

### 1 Queen St (Customs St to Mayoral Dr) – cont.

#### At locations with ABS stations: Station type

- For the Queen St 'PT Mall' in AART, the use of **central median stations** has been proposed. The figure below illustrates the station within the corridor and it is noted that the standard provision of the ABS is for a corridor width of 10.8m at the stations
- Central ROW with central median stations** have been chosen for this section as they will provide better 'context' for the public transport operations to have combined central median stations within the Queen St 'PT Mall'. This will allow for boarding and alighting for both directions of the service. It will also reduce the costs associated with the infrastructure and equipment in a section of the corridor that has no constraints on the corridor width to deliver the high quality rapid transit facilities required for the ABS
- It is possible to easily accommodate AART in the existing carriageway, with sufficient footpath space available
- For the creation of the Queen St 'PT Mall', it is therefore expected that the proposed AART option will provide some level of 'shared space' for the purposes of accessing buildings along Queen St, particularly in areas around the Civic Centre. A majority of the buildings within the corridor between Customs St and Mayoral Dr could be serviced from roads at the rear of the buildings or from side roads

Cross sections (cont.)

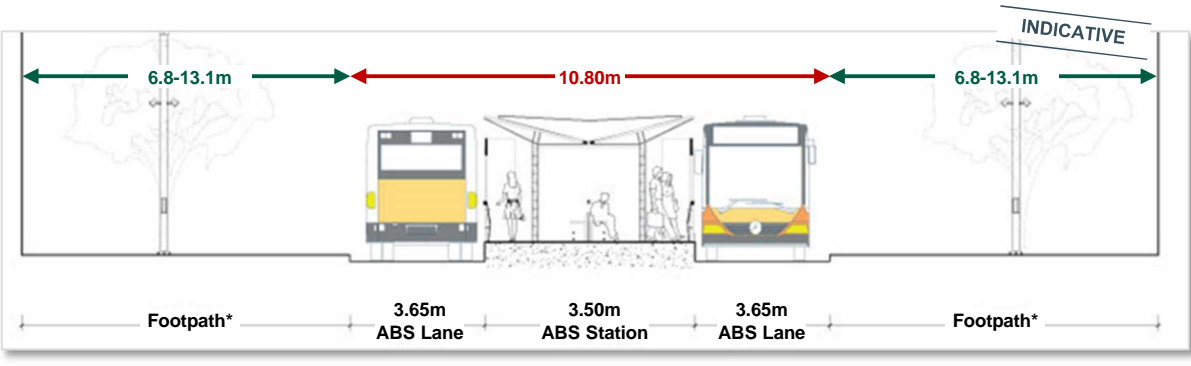

Note: \* This could include cycling facilities, streetscaping / landscaping etc.



# Each of these central median stations will be located at major intersections

## AART

## AART+

### 1 Queen St (Customs St to Mayoral Dr) – cont.

Full page designs are included in the Appendix

#### At locations with ABS stations: Station design

Cross sections (cont.)

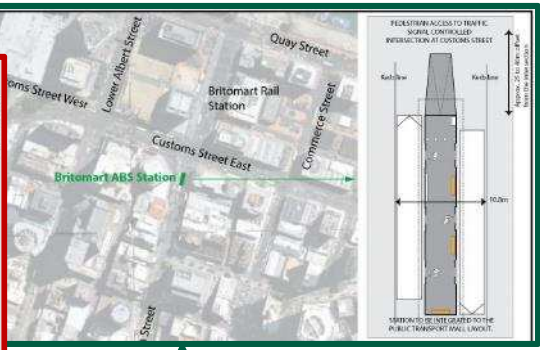
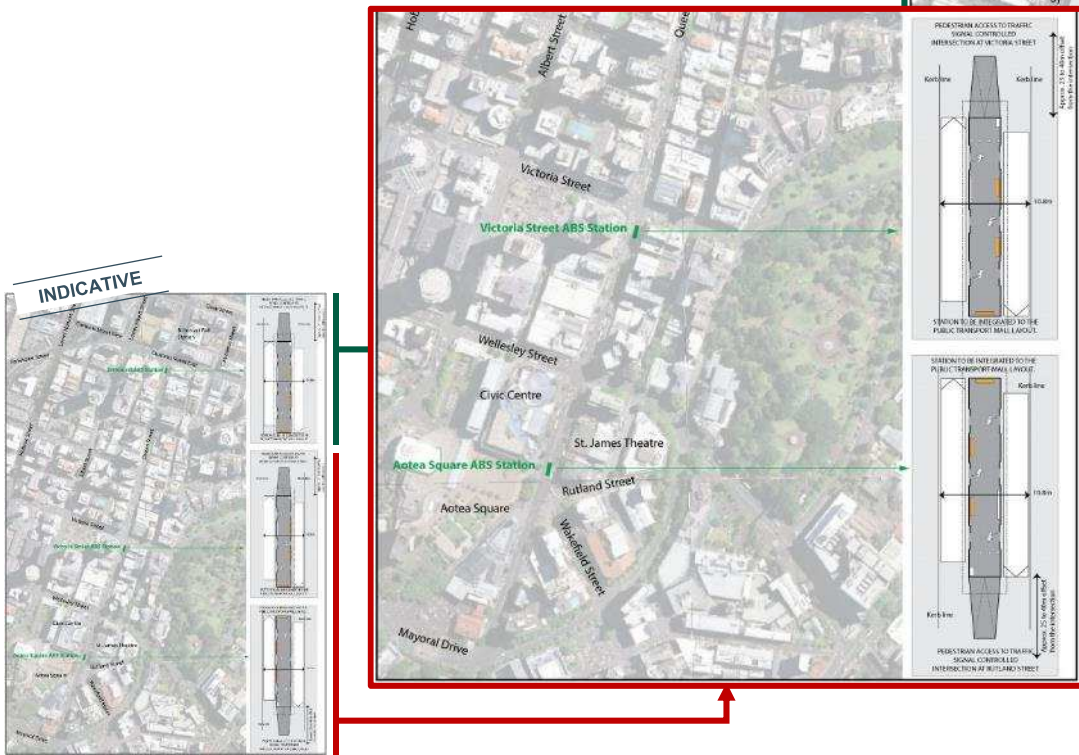

- Each of the ABS stations will be associated with major intersections that cross the Queen St corridor
- The intersections will provide increased accessibility to the cross street activities and, although the area will be designated as a PT Mall, it is preferable to maintain the crossing areas through a formalised intersection design

# General traffic will run along either side of the central median ABS lanes in the AART Upper Queen St section

## AART

## AART+

### 2 Upper Queen St (Mayoral Dr to Ian McKinnon Dr)

#### At locations without ABS stations

- The Upper Queen St corridor between Mayoral Dr and Ian McKinnon Dr has a very steep section between Waverly St and K'Road
- Close to the Mayoral Dr intersection, the corridor width is approximately 16.0m. This widens between Waverley St and K'Road as there is a planted central median along this part of the corridor; the kerb to kerb width at this location is approximately 18.5m
- In this section, the building to building space varies only slightly between 26.0m and 27.0m up to the motorway bridge on Upper Queen St (at the intersection with Ian McKinnon Dr)
- In AART, **central median ROW** will be established throughout the corridor and at each of the intersections along the corridor. In this instance, the preferred minimum width for the ABS ROW is 7.3m with general traffic also incorporated (equating to a total mid-block corridor width of 13.7m). General traffic will be separated from the ABS lane by utilising a rubber or composite lane separator that ensures exclusive use of the transit lane. This could be increased to 7.5m if it was deemed necessary to have any raised kerbs between the parallel ABS lanes

Cross sections (cont.)

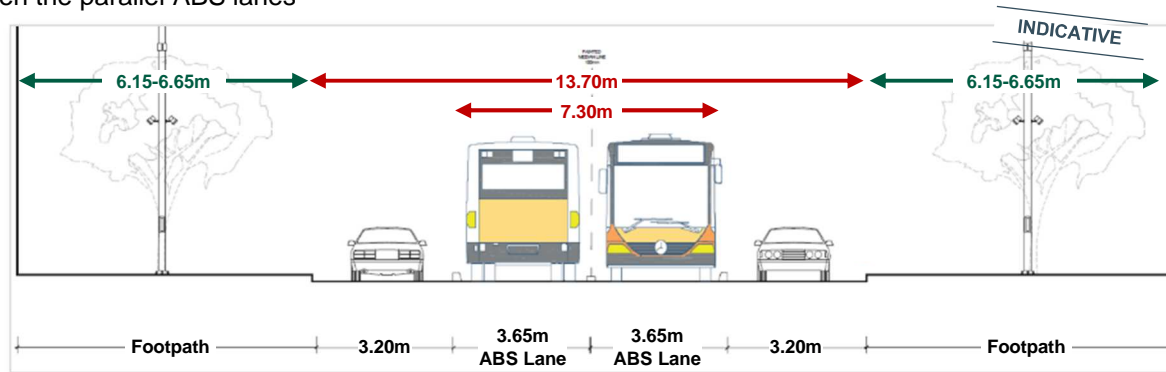

# In AART, parallel offset median stations with central median ROW will be used at the K'Road ABS station...

## AART

## AART+

### 2 Upper Queen St (Mayoral Dr to Ian McKinnon Dr) – cont.

#### At locations with ABS stations: Station type

- The Upper Queen St section includes two ABS stations, K'Road and Ian McKinnon. **Parallel offset median stations** (shown below) are proposed for the K'Road station while a **central median station** is proposed for the Ian McKinnon station. The standard provision of the ABS is for a corridor width of 16.2m (for parallel offset median stations) and 17.2m (for central median stations) at the station and general traffic lanes
- This will provide a consistent approach to all corridors for AART and enable a provision of all facilities that can fit within a constrained corridor. It will also provide a greater definition of the station locations in the corridor and provide for high quality facilities
- It is possible to easily accommodate AART in the existing carriageway. This may mean that additional facilities in this section such as cycle lanes or additional footpath width could be provided

Cross sections (cont.)

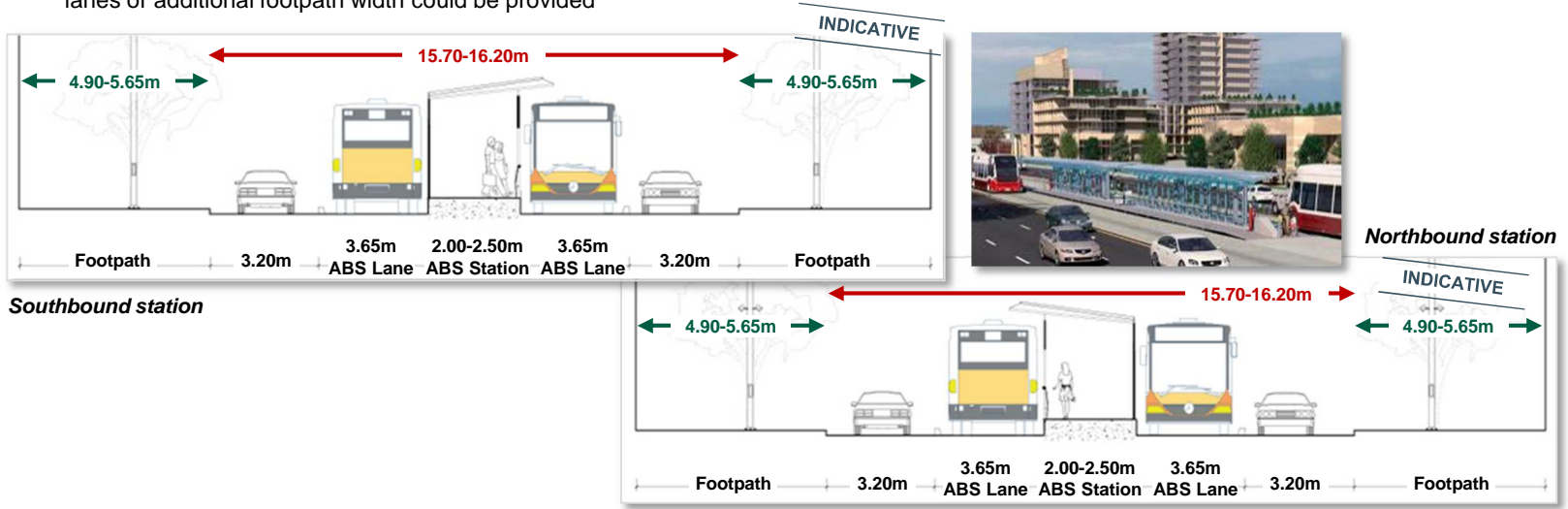

# ... while central median stations with central median ROW will be used at the Ian McKinnon ABS station

## AART

## AART+

### 2 Upper Queen St (Mayoral Dr to Ian McKinnon Dr) – cont.

Full page designs are included in the Appendix

Cross sections (cont.)

#### At locations with ABS stations: Station design

- Each ABS station will be associated close to major intersections that cross the corridor. The intersections will provide pedestrian accessibility to the ABS stations, providing for safe crossing locations for passengers
- There are two station locations in this section:
  - the station at the intersection of K’Road & Upper Queen St will use **central median ROW with parallel offset median stations**
  - the mid-block station where Ian McKinnon Dr meets Dominion Rd will use **central median ROW with central median stations**

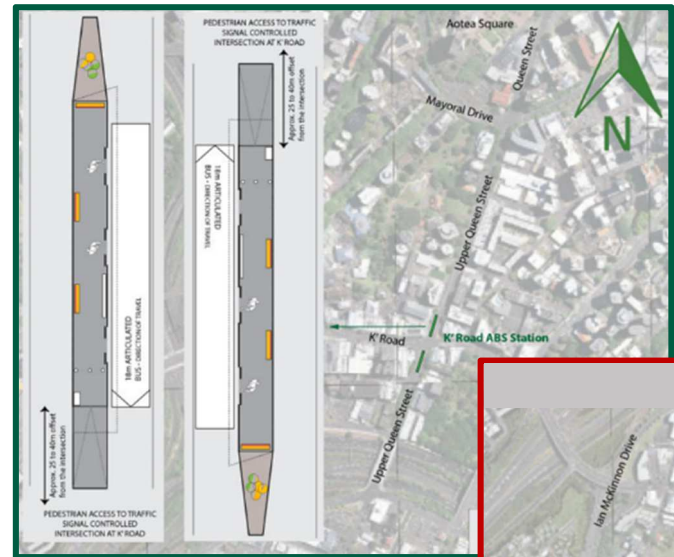

# In AART, the Dominion Rd to Mt Roskill Junction corridor will use central medial ROW for ABS vehicles

## AART

## AART+

### 3 Dominion Rd to Mt Roskill Junction

#### At locations without ABS stations

- The Dominion Rd to Mt Roskill Junction corridor varies significantly along its 5km length and, in most cases, has a kerb to kerb width of c.13.0-14.5m. This widens up to c.29m close to the interface with the lan McKinnon Dr section and to 16.5m close to the Balmoral Rd intersection. The building to building widths vary significantly through this corridor between 20.0m and 32.0m
- In AART, **central medial ROW** will be established throughout the corridor and at each of the intersections along the corridor. For the Dominion Rd section, which incorporates general traffic, the road corridor width is 13.7m

Cross sections (cont.)

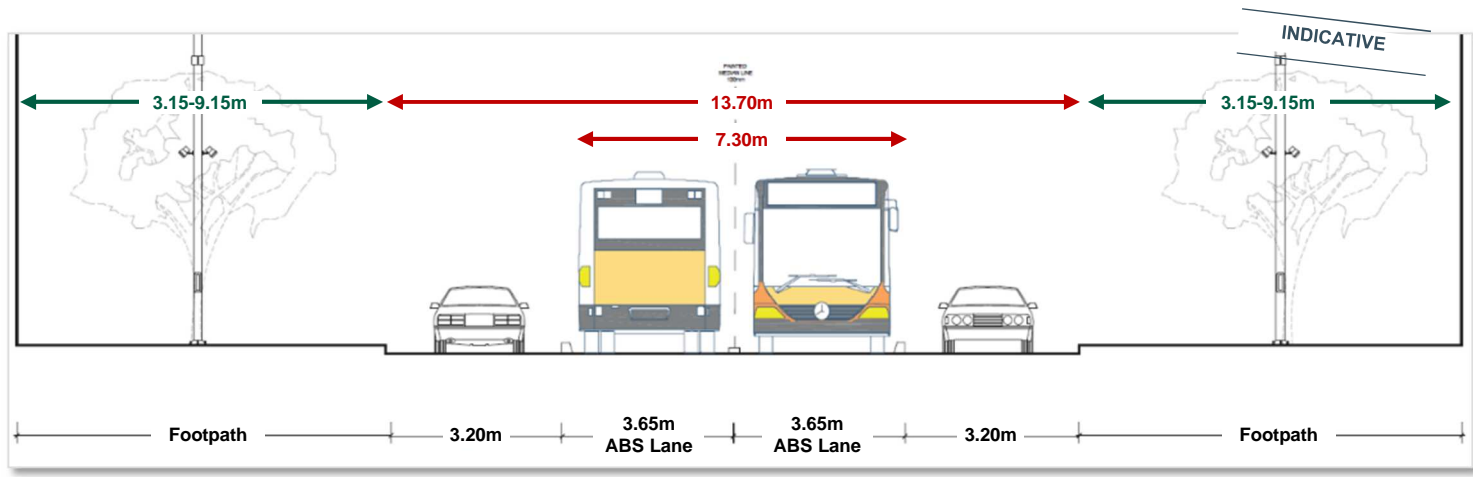

# Parallel offset median stations are proposed for this part of the AART option

## AART

## AART+

### 3 Dominion Rd to Mt Roskill Junction – cont.

#### At locations with ABS stations: Station type

- **Central median ROW with parallel offset median stations** is proposed for the Dominion Rd to Mt Roskill Junction corridor. The standard provision of the ABS is for a corridor width of 16.2m at the station and general traffic lanes
- This will provide a consistent approach to all corridors for AART and enable a provision of all facilities that can fit within a constrained corridor. It will also provide a greater definition of the station locations in the corridor and provide for high quality facilities
- It is possible to easily accommodate AART in the existing carriageway. This may mean that additional facilities in this section such as cycle lanes or additional footpath width could be provided

Cross sections (cont.)

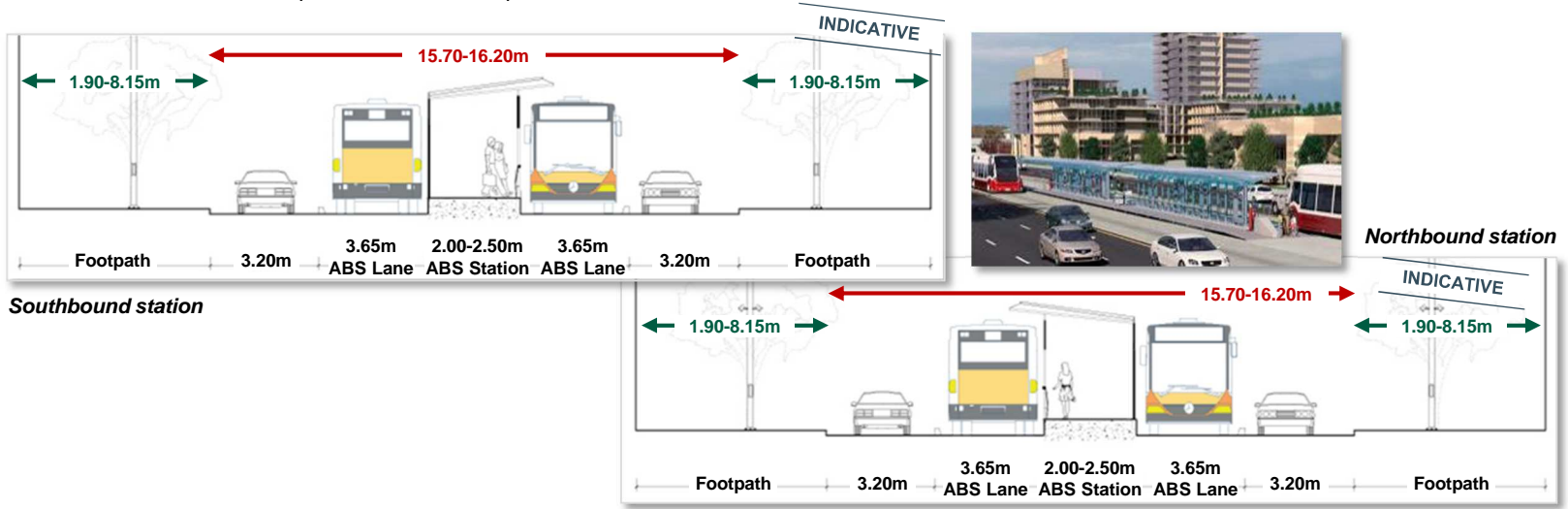

# These parallel offset median stations will be located close to major intersections along this AART corridor



## 3 Dominion Rd to Mt Roskill Junction – cont.

### At locations with ABS stations: Station design

- Each ABS station location in this corridor will be associated close to major intersections that cross the corridor. The intersections will provide pedestrian accessibility to the ABS stations, allowing for safe crossing of passengers
- There are seven ABS station locations in this section:
  - Tawari St
  - Valley Rd
  - Milton Rd
  - Balmoral Shops (Balmoral Rd)
  - Lambeth Rd
  - Mt Roskill Shops (Mount Albert Rd)
  - Mt Roskill Junction (Denbigh Ave)
- All locations will use **central median ROW with parallel offset median stations**
- NB: the RHS diagram illustrates the entire Dominion Rd corridor in two columns

Cross sections (cont.)

Full page designs are included in the Appendix

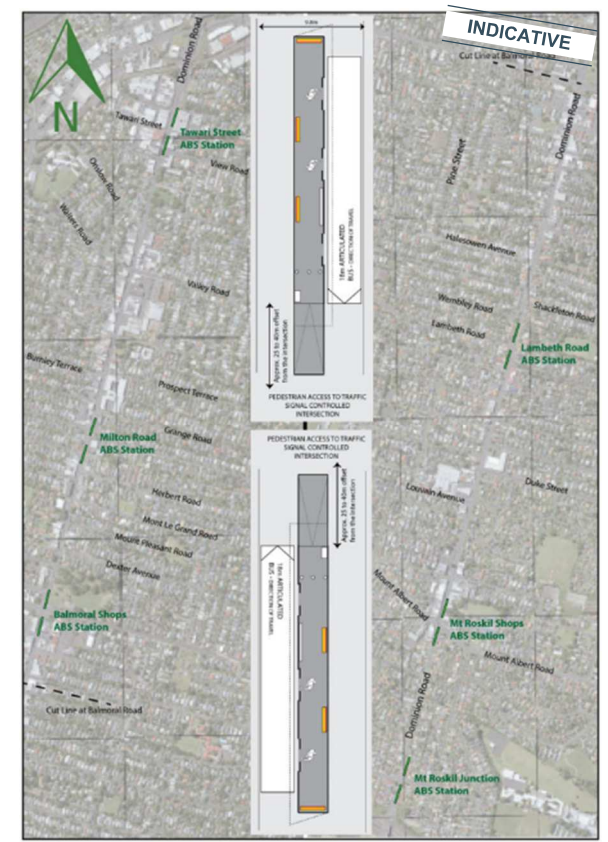

AART

AART+

## Cross sections (cont.)

### 4 SH20 Offline Busway

- In a previous study (Jacobs, 2016), a series of options were proposed for a dedicated right of way between Denbigh Ave and Dominion Rd along the SH20 motorway corridor, which connected to the Airport terminal via the Airport Business District (George Bolt Memorial Dr)
- AART will adopt the same preferred corridor and the eight station locations along this route as was used in the previous study:
  - Hillsborough
  - Onehunga (Onehunga Rail Station and Onehunga Mall Rd)
  - Mangere Bridge
  - Favona
  - Mangere Town Centre
  - Ascot
  - Airport Business District
  - Auckland International Airport Terminal
- The SH20 busway section will be designed to be similar to the standards for the Northern Busway that is already in operation by AT. Therefore, the key standards adopted will be as previously reported:
  1. Busway section from the Airport to Onehunga in SH20 / SH20A corridors (offline and dedicated)
    - a. busway designed as two-way, two-lane bus-only roadway with 100km/hr design speed
    - b. busway lanes 3.65m wide with a 0.5m median separator
    - c. busway grade separated over other roads with no crossing intersections
    - d. pedestrian crossings grade separated over busway
    - e. busway pavement is reinforced concrete or deep lift asphaltic cement (AC) in all running lanes and bus stops
    - f. ABS stations to be standard **central median stations** (same orientation and design as the Queen St PT Mall)
  2. Busway section from Onehunga to Denbigh Ave (via Hillsborough) in SH20 / SH20A corridors (offline and dedicated). This was not previously provided for in any of the bus options in the Jacobs reporting and was only an LRT proposal; however, this connection provides for access to the Dominion Rd ABS corridor and therefore will be adopted at the same design standards as 1a-1f above



# There are a number of key design features of the SH20 offline busway (1 of 2)

AART

AART+

Cross sections (cont.)

## 4 SH20 Offline Busway – cont.

### Key design features

- There will be a dedicated right of way between Mt Roskill Station (Denbigh Ave) and Hillsborough Station, with an offline dedicated facility alongside the SH20 motorway. Mt Roskill Station will include signal controlling of the Dominion Rd / Denbigh Ave intersection and will additionally introduce a park and ride facility to accommodate up to 150 vehicles
- The SH20 corridor between Denbigh Ave intersection and Hillsborough, once it is south of the station park and ride, will operate parallel to the SH20 corridor and be c.7.8m wide. The offline busway will pass under the Frost Rd overbridge and Hayr Rd before accessing land to the south-east of Hillsborough Rd via a tunnelled section under the Hillsborough Rd motorway intersection
- For access to Onehunga, the SH20 offline busway will need to pass under the Queenstown Rd motorway ramps and connect to the proposed solution (previously illustrated in the Jacob's reporting), which was for a section of elevated busway between Queenstown Rd and Princes St (over the lagoon that runs parallel to Beachcroft Ave) that would then access Princes St and Onehunga from a newly constructed at-grade traffic signal intersection at Beachcroft Ave and Princes St
- Princes St to Onehunga Mall Rd was proposed as a key route for the previous BRT alignment. This then accessed an elevated station above Onehunga Rail Station. On Princes St itself, all parking was proposed to be removed and transit lanes would be able to be accommodated in this corridor without impact on any building lines. This is considered a suitable option for the ABS and therefore will be included as part of the SH20 offline solution (with access to Onehunga), with the only change being that the ABS lanes will continue to operate in the central median ROW as there are no stations until the interchange with Onehunga Rail Station



**Mt Roskill Junction ABS Station and Park & Ride facility**

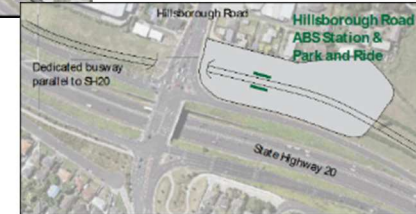

**Hillsborough ABS Station and Park & Ride facility**

# There are a number of key design features of the SH20 offline busway (2 of 2)

AART

AART+

4

## SH20 Offline Busway – cont.

### Key design features – cont.

- From Onehunga to the Airport, the ABS will adopt the proposals as shown in the BRT scheme from the 2016 Jacobs study:
  - south of Onehunga Rail Station, the route to the SH20 offline busway will be via Onehunga Harbour Rd and then to the motorway via Onehunga Harbour Rd and Neilson St
  - buses will operate across Manukau Harbour Bridge via kerbside shoulder lanes and use the ramps at Mahunga Dr to access the elevated station at Mangere Bridge. The ABS vehicles will be provided dedicated lanes on the motorway ramps to access the stopline at Mahunga Dr and Rimu Rd
  - at this point, the SH20 offline busway facility will restart and operate parallel to the SH20 corridor
  - an offline station, and feasibly a park and ride facility, will be provided at Favona between Walmsley Rd and the motorway on and off ramps of McKenzie Rd
  - an offline elevated station will be provided at Mangere Town Centre at the location of the motorway on and off ramps of Bader Dr. Alterations to the Bader Dr overbridge will accommodate the station access
  - close to Kirkbride Rd, the SH20 offline busway alignment must transition to the SH20A median as previously proposed. This includes the requirement for the Kirkbride Bridge separation project, which also includes the closure of Montgomerie Rd
  - an at-grade median right of way and station will be provided at Ascot Station. From there, ABS vehicles will continue to operate in the central median up to a point just north of the Airport Business District, when it again transitions and operates on the northern side of Tom Pearce Dr for access to the at-grade station and then onwards to the Auckland Airport terminal

Cross  
sections  
(cont.)

# AART+ by section

ROW	Stations
Fully dedicated, central	Kerbside pairs
Central	Lateral offset median
Central	Lateral offset median
Kerbside	Kerbside pairs
Fully dedicated, central	Kerbside pairs

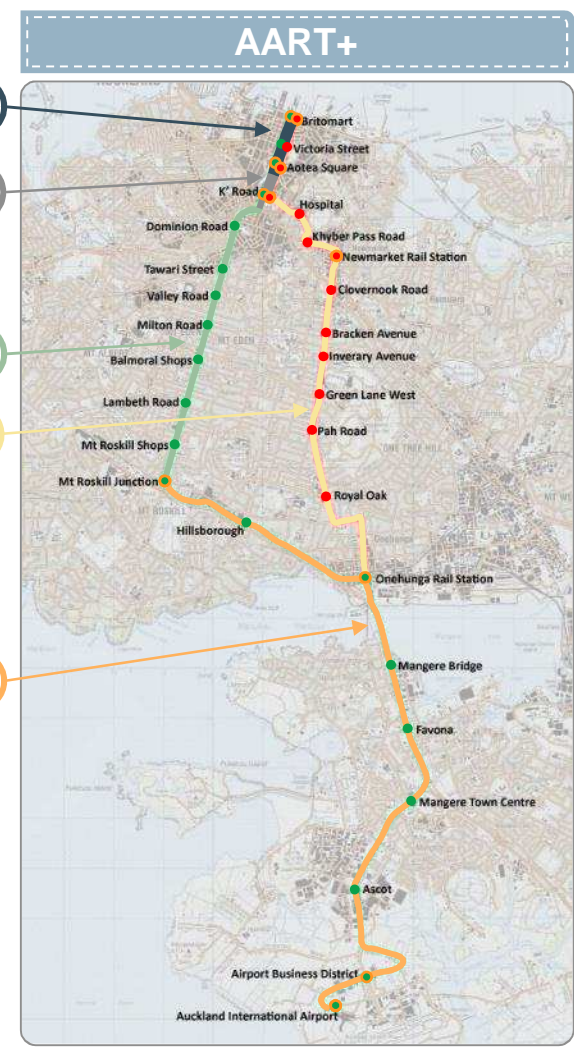
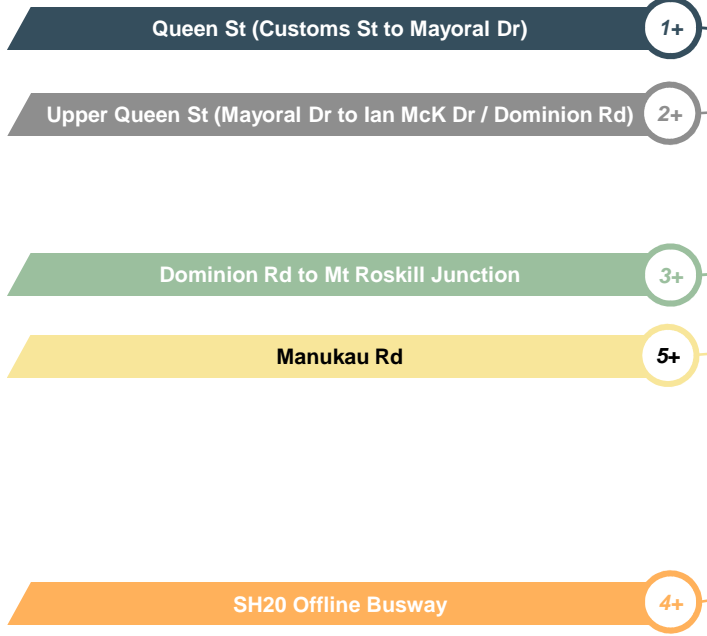

# As in AART, AART+ will also provide a PT Mall along lower Queen St with dedicated ABS lanes throughout



Cross sections (cont.)

1+ Queen St (Customs St to Mayoral Dr)

At locations without ABS stations

- The Queen St corridor between Customs St and Mayoral Dr has a relatively consistent width up to the Civic Centre of between 11.5m and 13.5m (close to the Mayoral Dr intersection). Outside the Civic Centre and the St James Theatre, the corridor is widened to allow for the existing bus bays, at which point the kerb to kerb width is approximately 19.0m
- There are large variations in the building to building space in this corridor of between 37.0m (at the Civic Centre) and 24.4m (between Customs St and Fort Lane)
- For the design of AART+, it is proposed that the right of way is established throughout this corridor and at each of the intersections along the corridor. In this instance, the preferred minimum width for the ABS is 7.3m. This could be increased to 7.5m if it was deemed necessary to have any raised kerbs between the parallel ABS lanes. However, given the area will be designated as a 'Public Transport Mall', with only the ABS vehicles, pedestrians, cyclists and the occasional vehicle for servicing of the buildings (accessing via a shared surface facility), the speed in this section of the corridor is expected to be well below 30km/hr and could well be posted and enforced at between 20km/hr and 30 km/hr

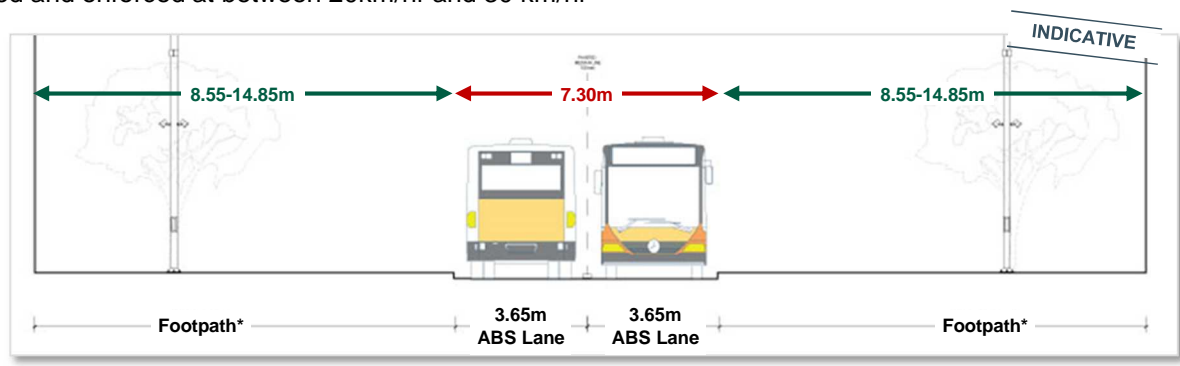

Note: \* This could include cycling facilities, streetscaping / landscaping etc.

# Kerbside station pairs will be used in the Lower Queen St section of AART+



Cross sections (cont.)

1+ Queen St (Customs St to Mayoral Dr) – cont.

At locations with ABS stations: Station type

- For the Queen St 'PT Mall' in AART+, the use of **kerbside pairs** has been proposed. The figure below illustrates the station within the corridor and it is noted that the standard provision of the ABS is for a corridor width of 13.45m at the stations
- Central median ROW with kerbside station pairs** has been chosen for this section as it will provide a consistent approach to all corridors for the AART+ option and enable a better fit with the existing public transport services in areas outside the Queen St 'PT Mall'. This will allow for boarding and alighting for both directions of the service. The use of the combined location will mean greater definition of the station locations in the corridor
- It is possible to easily accommodate AART+ in the existing carriageway, with sufficient footpath space available
- For the creation of the Queen St 'PT Mall', it is therefore expected that the proposed AART+ option will provide some level of 'shared space' for the purposes of accessing buildings along Queen St, particularly in areas around the Civic Centre. A majority of the buildings within the corridor between Customs St and Mayoral Dr could be serviced from roads at the rear of the buildings or from side roads

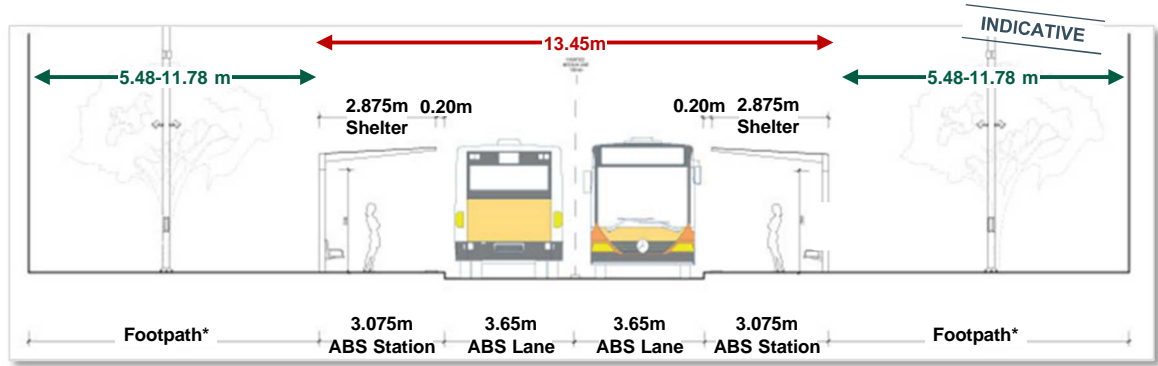

Note: \* This could include cycling facilities, streetscaping / landscaping etc.

# Each kerbside station pair will be located at a major intersection



**1+** Queen St (Customs St to Mayoral Dr) – cont.

Full page designs are included in the Appendix

- At locations with ABS stations: Station design**
- Each ABS station will be associated with major intersections that cross the Queen St corridor
  - The intersections will provide increased accessibility to the cross street activities and, although the area will be designated as a PT Mall, it is preferable to maintain the crossing areas through a formalised intersection design

Cross sections (cont.)



Britomart & Victoria St

Aotea Square

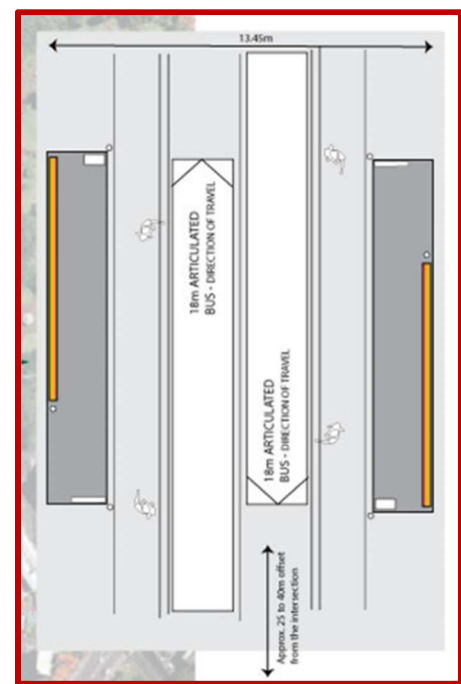
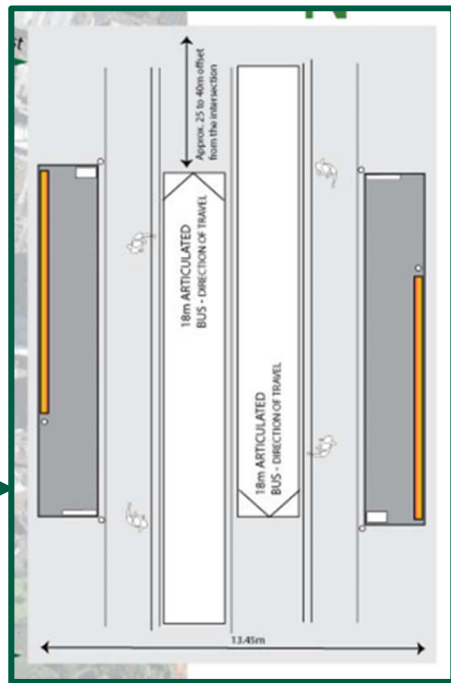

# General traffic will run along either side of the central median ABS lanes in the AART+ Upper Queen St section



Cross sections (cont.)

## 2+ Upper Queen St (Mayoral Dr to Ian McKinnon Dr)

### At locations without ABS stations

- The Upper Queen St corridor between Mayoral Dr and Ian McKinnon Dr has a very steep section between Waverly St and K'Road
- Close to the Mayoral Dr intersection, the corridor width is approximately 16.0m. This widens between Waverley St and K'Road as there is a planted central median along this part of the corridor; the kerb to kerb width at this location is approximately 18.5m
- In this section, the building to building space varies only slightly between 26.0m and 27.0m up to the motorway bridge on Upper Queen St (at the intersection with Ian McKinnon Dr)
- In AART+, **central median ROW** will be established throughout this part of the corridor and at each of the intersections along the corridor. In this instance, the preferred minimum width for the ABS ROW is 7.3m with general traffic also incorporated (equating to a total mid-block corridor width of 13.7m). General traffic will be separated from the ABS lane by utilising a rubber or composite lane separator that ensures exclusive use of the transit lane. This could be increased to 7.5m if it was deemed necessary to have any raised kerbs between the parallel ABS lanes

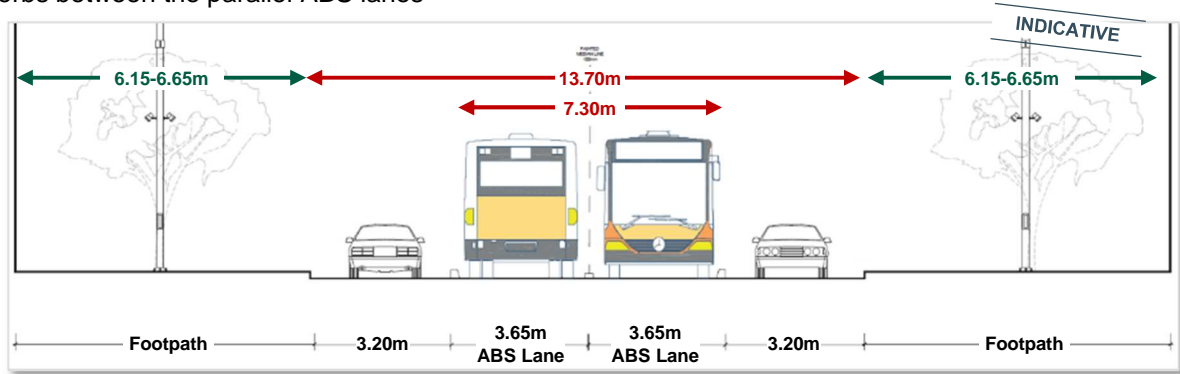

# In AART+, lateral offset median stations with central median ROW will be used at the K'Road ABS station...



Cross sections (cont.)

2+ Upper Queen St (Mayoral Dr to Ian McKinnon Dr) – cont.

At locations with ABS stations: Station type

- The Upper Queen St section includes two ABS stations, K'Road and Ian McKinnon. **Lateral offset median stations** (shown below) are proposed for the K'Road station while **kerbside stations** are proposed for the Ian McKinnon station. The standard provision of the ABS is for a corridor width of 16.2m (for lateral offset median stations) and 19.85m (for kerbside stations) at the station and general traffic lanes
- This will provide a consistent approach to all corridors for AART+, enable a better fit with the existing public transport services, and provide greater definition of the station locations but also provide for high quality facilities in relatively constrained widths
- It is possible to easily accommodate AART+ in the existing carriageway. This may mean that additional facilities in this section such as cycle lanes or additional footpath width could be provided

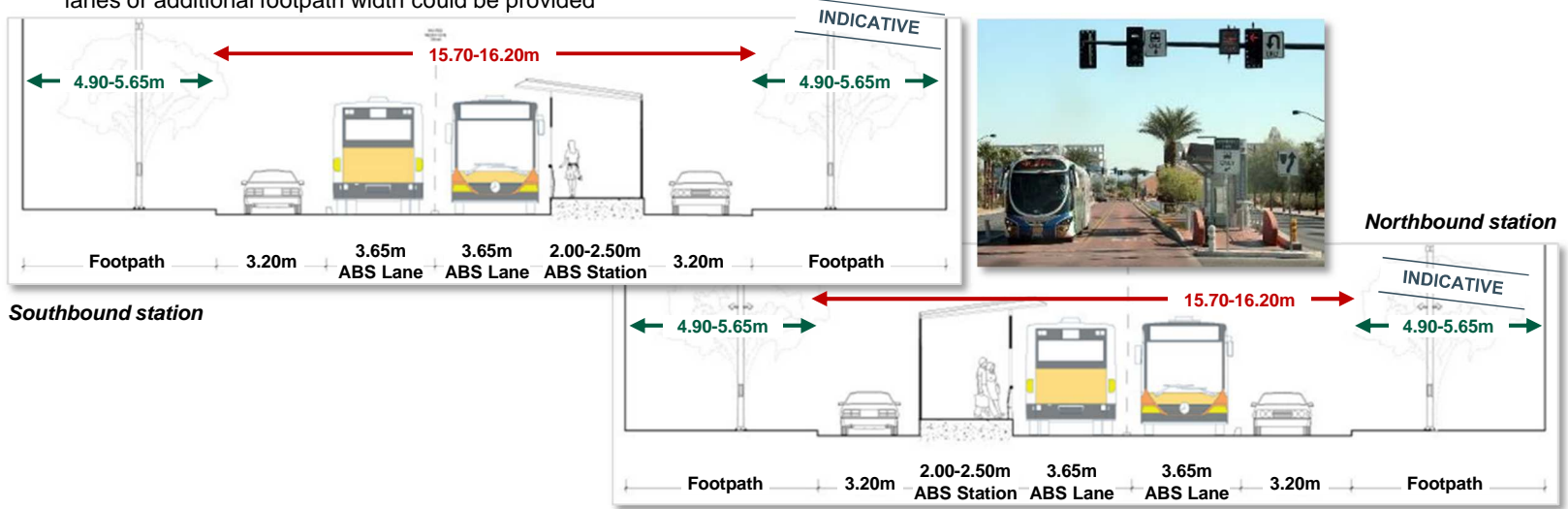



# ... while kerbside stations with central median ROW will be used at the Ian McKinnon ABS station



## 2+ Upper Queen St (Mayoral Dr to Ian McKinnon Dr) – cont.

Full page designs are included in the Appendix

Cross sections (cont.)

### At locations with ABS stations: Station design

- Each ABS station will be associated close to major intersections that cross the corridor. The intersections will provide pedestrian accessibility to the ABS stations, providing for safe crossing locations for passengers
- There are two station locations in this section:
  - the station at the intersection of K'Road & Upper Queen St will use **central median ROW with lateral offset median stations**
  - the mid-block station where Ian McKinnon Dr meets Dominion Rd will use **central median ROW with kerbside stations**

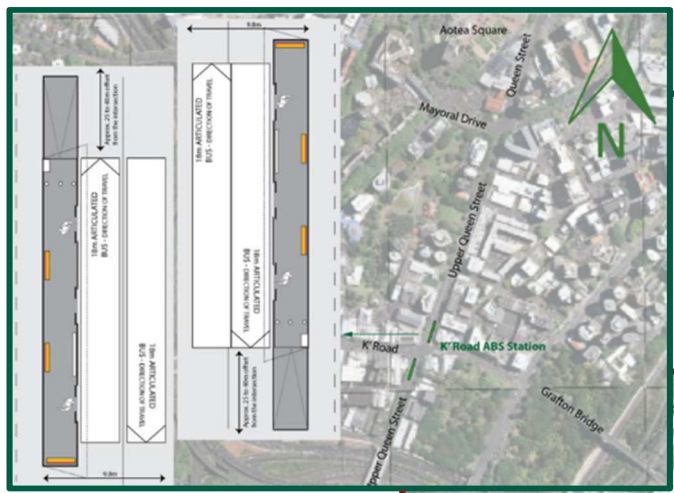

# The Dominion Rd to Mt Roskill Junction corridor in AART+ will use central medial ROW for ABS vehicles



## 3+ Dominion Rd to Mt Roskill Junction

### At locations without ABS stations

- The Dominion Rd to Mt Roskill Junction corridor varies significantly along its 5km length and, in most cases, has a kerb to kerb width of c.13.0-14.5m. This widens up to c.29m close to the interface with the lan McKinnon Dr section and to 16.5m close to the Balmoral Rd intersection. The building to building widths vary significantly through this corridor between 20.0m and 32.0m
- In AART+, **central median ROW** will be established throughout this part of the corridor and at each of the intersections along the corridor. For the Dominion Rd section, which incorporates general traffic, the road corridor width is 13.7m

Cross sections (cont.)

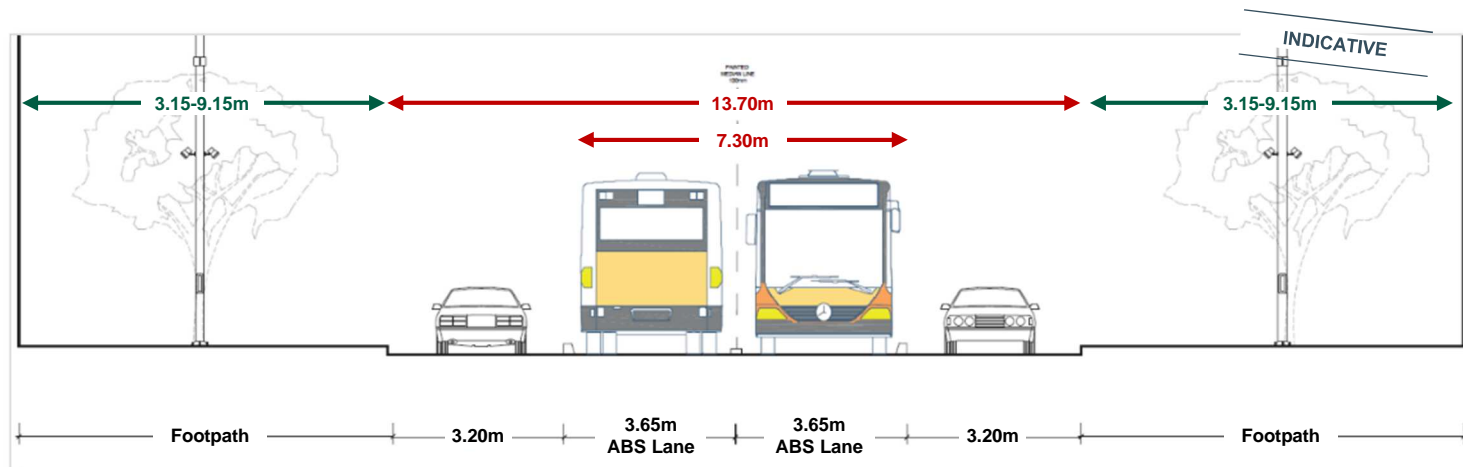

# Lateral offset median stations are proposed for this part of the AART+ option

## AART

## AART+

### 3+ Dominion Rd to Mt Roskill Junction – cont.

#### At locations with ABS stations: Station type

- **Central median ROW with lateral offset median stations** is proposed for the Dominion Rd to Mt Roskill Junction corridor. The standard provision of the ABS is for a corridor width of 16.2m at the station and general traffic lanes
- This will provide a consistent approach to all corridors for AART+, enable a better fit with the existing public transport services, and provide greater definition of the station locations but also provide for high quality facilities in relatively constrained widths
- It is possible to easily accommodate AART+ in the existing carriageway. This may mean that additional facilities in this section such as cycle lanes or additional footpath width could be provided

Cross sections (cont.)

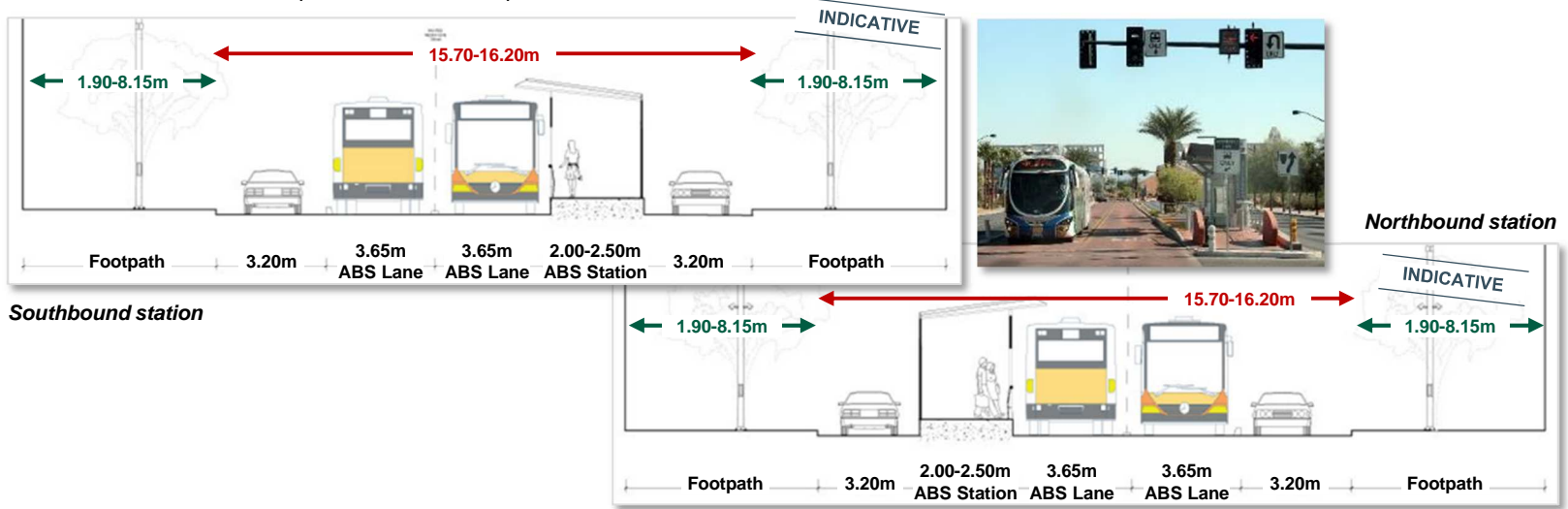

# The lateral offset median stations at the ABS stop locations in this AART+ corridor will be close to major intersections



## 3+ Dominion Rd to Mt Roskill Junction – cont.

### At locations with ABS stations: Station design

- Each ABS station location in this corridor will be associated close to major intersections that cross the corridor. The intersections will provide pedestrian accessibility to the ABS stations, allowing for safe crossing of passengers
- There are seven ABS station locations in this section:
  - Tawari St
  - Valley Rd
  - Milton Rd
  - Balmoral Shops (Balmoral Rd)
  - Lambeth Rd
  - Mt Roskill Shops (Mount Albert Rd)
  - Mt Roskill Junction (Denbigh Ave)
- All locations will use **central median ROW with lateral offset median stations**
- NB: the RHS diagram illustrates the entire Dominion Rd corridor in two columns

Cross sections (cont.)

Full page designs are included in the Appendix

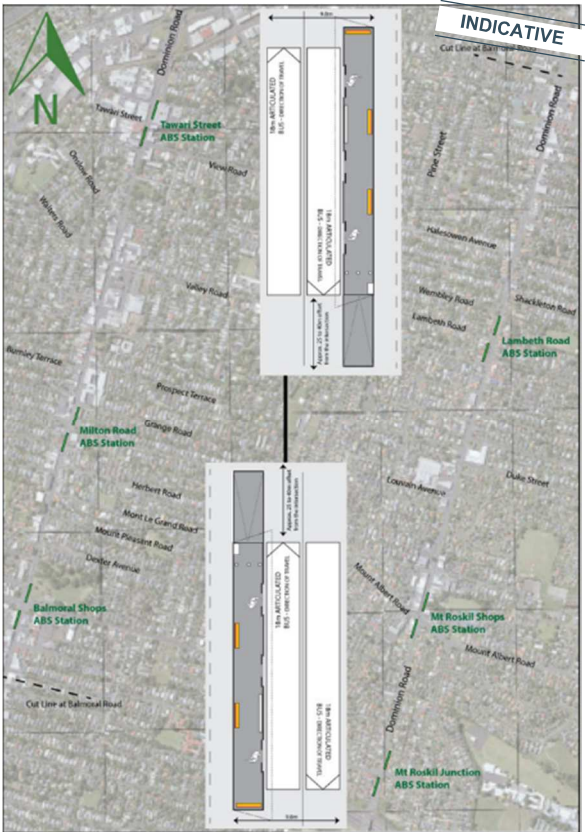

AART

AART+

4+

## SH20 Offline Busway

Cross  
sections  
(cont.)

- In a previous study (Jacobs, 2016), a series of options were proposed for a dedicated right of way between Denbigh Ave and Dominion Rd along the SH20 motorway corridor, which connected to the Airport terminal via the Airport Business District (George Bolt Memorial Dr)
- AART+ will adopt the same preferred corridor and the eight station locations along this route as was used in the previous study:
  - Hillsborough
  - Onehunga (Onehunga Rail Station and Onehunga Mall Rd)
  - Mangere Bridge
  - Favona
  - Mangere Town Centre
  - Ascot
  - Airport Business District
  - Auckland International Airport Terminal
- The SH20 busway section will be designed to be similar to the standards for the Northern Busway that is already in operation by AT. Therefore, the key standards adopted will be as previously reported:
  1. Busway section from the Airport to Onehunga in SH20 / SH20A corridors (offline and dedicated)
    - a. busway designed as two-way, two-lane bus-only roadway with 100km/hr design speed
    - b. busway lanes 3.65m wide with a 0.5m median separator
    - c. busway grade separated over other roads with no crossing intersections
    - d. pedestrian crossings grade separated over busway
    - e. busway pavement is reinforced concrete or deep lift asphaltic cement (AC) in all running lanes and bus stops
    - f. ABS stations to be standard **kerbside pairs** (same orientation and design as the Queen St PT Mall)
  2. Busway section from Onehunga to Denbigh Ave (via Hillsborough) in SH20 / SH20A corridors (offline and dedicated). This was not previously provided for in any of the bus options in the Jacobs reporting and was only an LRT proposal; however, this connection provides for access to the Dominion Rd ABS corridor and therefore will be adopted at the same design standards as 1a-1f above

# There are a number of key design features of the SH20 offline busway (1 of 2)



## 4+ SH20 Offline Busway – cont.

### Key design features

- There will be a dedicated right of way between Mt Roskill Station (Denbigh Ave) and Hillsborough Station, with an offline dedicated facility alongside the SH20 motorway. Mt Roskill Station will include signal controlling of the Dominion Rd / Denbigh Ave intersection and will additionally introduce a park and ride facility to accommodate up to 150 vehicles
- The SH20 corridor between Denbigh Ave intersection and Hillsborough, once it is south of the station park and ride, will operate parallel to the SH20 corridor and be c.7.8m wide. The offline busway will pass under the Frost Rd overbridge and Hayr Rd before accessing land to the south-east of Hillsborough Rd via a tunnelled section under the Hillsborough Rd motorway intersection
- For access to Onehunga, the SH20 offline busway will need to pass under the Queenstown Rd motorway ramps and connect to the proposed solution (previously illustrated in the Jacob's reporting), which was for a section of elevated busway between Queenstown Rd and Princes St (over the lagoon that runs parallel to Beachcroft Ave) that would then access Princes St and Onehunga from a newly constructed at-grade traffic signal intersection at Beachcroft Ave and Princes St
- Princes St to Onehunga Mall Rd was proposed as a key route for the previous BRT alignment. This then accessed an elevated station above Onehunga Rail Station. On Princes St itself, all parking was proposed to be removed and transit lanes would be able to be accommodated in this corridor without impact on any building lines. This is considered a suitable option for the ABS and therefore will be included as part of the SH20 offline solution (with access to Onehunga), with the only change being that the ABS lanes will continue to operate in the central median ROW as there are no stations until the interchange with Onehunga Rail Station



**Mt Roskill Junction ABS Station and Park & Ride facility**

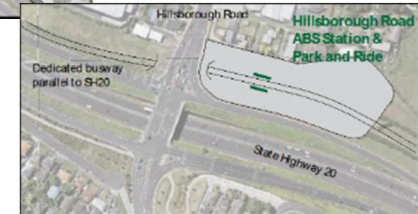

**Hillsborough ABS Station and Park & Ride facility**

Cross sections (cont.)

# There are a number of key design features of the SH20 offline busway (2 of 2)

AART

AART+

4+

SH20 Offline Busway – cont.

### Key design features – cont.

- From Onehunga to the Airport, the ABS will adopt the proposals as shown in the BRT scheme from the 2016 Jacobs study:
  - south of Onehunga Rail Station, the route to the SH20 offline busway will be via Onehunga Harbour Rd and then to the motorway via Onehunga Harbour Rd and Neilson St
  - buses will operate across Manukau Harbour Bridge via kerbside shoulder lanes and use the ramps at Mahunga Dr to access the elevated station at Mangere Bridge. The ABS vehicles will be provided dedicated lanes on the motorway ramps to access the stopline at Mahunga Dr and Rimu Rd
  - at this point, the SH20 offline busway facility will restart and operate parallel to the SH20 corridor
  - an offline station, and feasibly a park and ride facility, will be provided at Favona between Walmsley Rd and the motorway on and off ramps of McKenzie Rd
  - an offline elevated station will be provided at Mangere Town Centre at the location of the motorway on and off ramps of Bader Dr. Alterations to the Bader Dr overbridge will accommodate the station access
  - close to Kirkbride Rd, the SH20 offline busway alignment must transition to the SH20A median as previously proposed. This includes the requirement for the Kirkbride Bridge separation project, which also includes the closure of Montgomerie Rd
  - an at-grade median right of way and station will be provided at Ascot Station. From there, ABS vehicles will continue to operate in the central median up to a point just north of the Airport Business District, when it again transitions and operates on the northern side of Tom Pearce Dr for access to the at-grade station and then onwards to the Auckland Airport terminal

Cross sections (cont.)

# There will be critical areas of dedicated kerbside ROW with kerbside stations on the Manukau Rd corridor (1 of 2)

AART

AART+

## 5+ Manukau Rd

### Cross sections (cont.)

- The Manukau Rd services will operate as Airport to Airport services via the CBD
- The routing has been derived to take account of the large patronage and high levels of accessibility, due to the large residential catchment along Manukau Rd and the ability to interface with a series of existing bus services and rail modes at Onehunga, Newmarket, Aotea and Britomart as well as the ferry services at Britomart
- The Manukau Rd corridor will have localised treatments to develop some critical areas of dedicated right of way with the operation of general traffic alongside the **kerbside ROW and kerbside stations**
- The 'pinch points' in the Manukau Rd corridor will not allow for full dedicated lanes; however, there are significant benefits for the delivery of a network 'all stops' and 'express' services route from the Airport to provide facilities wherever possible. Therefore, the design of the infrastructure must be driven by the service planning along the Manukau Rd corridor, with the aim of reducing bus travel times and delays along the corridor
- The Manukau Rd corridor has the following main sections, which are considered critical to the delivery of a viable project / scheme:
  - **Newmarket Rail Station to K'Road:** North of the Newmarket rail interchange and on the approach to the Khyber Pass Rd intersection, there are existing peak hour kerbside bus lanes that will require increased hours of operation to provide for the frequency of the services. Khyber Pass Rd also has existing peak hour kerbside bus lanes, which provide access and egress from Park Rd

The ABS will integrate to the Central Transit Corridor at Park Rd, and access both the medical school and hospital catchments on Park Rd prior to using the public transport only Grafton Bridge to connect to K'Road Station

Park Rd has existing peak hour kerbside bus lanes and high quality bus stop facilities that can accommodate the services from the ABS Manukau Rd corridor. If there are issues related to capacity of the stops and the frequency of the services, then there are areas that remain available for additional stop capacity



# There will be critical areas of dedicated kerbside ROW with kerbside stations on the Manukau Rd corridor (2 of 2)



Cross sections (cont.)

## 5+ Manukau Rd – cont.

- **Onehunga to Newmarket Rail Station:** This route will be via Onehunga Mall Rd to Trafalgar St and Manukau Rd allowing access and a set of stations at the Royal Oak catchment. It will then travel via Manukau Rd to Newmarket Rail Station. All of the stations in this section will be *kerbside stops and utilise kerbside rights of way wherever possible*, but particularly on the approach to the major intersections of Royal Oak, Pah Rd, Green Lane West and Great South Rd. At all of these intersections, provision of 'queue jumper' lanes and traffic signal priority will provide for increased travel time reductions and improved reliability

North of Clovernook Station, the ABS vehicles will pass through Broadway and access Newmarket Rail Station prior to heading onward to Khyber Pass Rd. While there are existing peak hour bus lanes and stop facilities in these sections, there remains significant parking in the off-peak and therefore the bus priority is inaccessible. Therefore, there needs to be greater consideration of removing all parking in the Broadway section between Khyber Pass Rd and Clovernook Rd to create an environment of intensive provision for public transport, whilst providing access for all modes, but relocating parking external to this 'zone'

This is particularly important between Remuera Rd intersection and Khyber Pass Rd in order to provide a significant and dedicated bus facility that provides high quality interchange with Newmarket Rail Station, which will be accessed via the concourse opposite Teed St

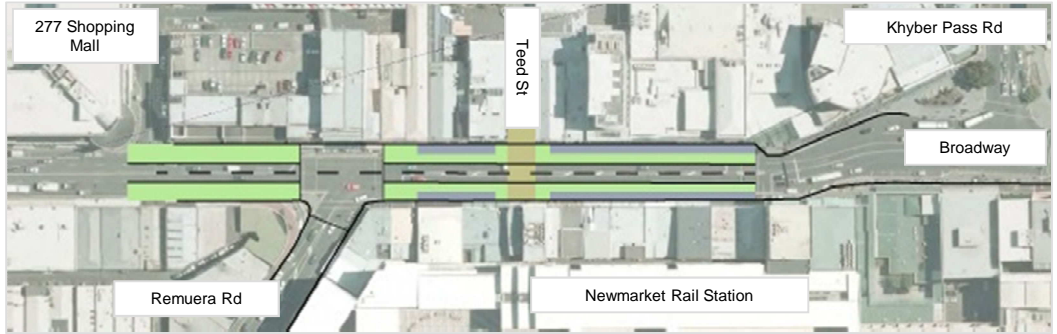

Newmarket Rail Station interchange with the ABS (Manukau Rd services only)

# There are a number of options available for accommodating passing in narrower cross sections

## AART

## AART+

### *Accommodating express services*

- Space permitting, in BRT design practice where 'express' or limited stop services operate 'on top' of 'all stops' services, there are sometimes passing lanes around stations, either a single one for both directions or one for each direction depending on the type of cross section. By offsetting the respective directional portions of median centre-platform stations, there would be a maximum of three lanes occupied by both the passing lanes and stopping position in both directions. In the case of the ABS, this would not be required or designed as this would clearly be a problem for most if not all of Dominion Rd and Manukau Rd, where space is limited
- However, passing in narrower cross sections can be accommodated in a number of ways, which could be evaluated for each ABS station in the detailed project development on a case by case basis, including:
  - having 'express' buses leave kerbside bus lanes to divert around 'all stops' ABS vehicles stopped at stations, which would be the case for the Manukau Rd services as part of AART+
  - having 'express' buses pass 'all stops' ABS vehicles stopped at stations by going into the opposing lanes of median stations with side platform, offset stations
  - having 'express' buses pass around 'all stops' ABS vehicles at intersections or in the mid-block sections where there are no stations and there are parallel ABS lanes that are only separated by road markings, which would be the main options for the Dominion Rd services as there is a consistent central ROW for AART and AART+
  - establishing areas at either end of median stations where 'all stops' ABS vehicles could 'hold' while 'express' buses pass around them, which is easily achieved with the use of the advanced fleet management, which would be required and expected as part of the ABS

# There should be no on-street parking in the immediate vicinity of the ABS stations for both options

## AART

## AART+

### On-street parking

- There should be no on-street parking in the immediate vicinity of the ABS stations. This is important for all styles of station for the ABS but most critically for the kerbside provision
- Past designs in Auckland would have considered the indenting of parking close to bus stops and provided for tapers into and out of the stops; however, for the production of a rapid transit system, the provision of parking has to be removed from the streetscape relative to the stations and the right of way for the public transport vehicles
- The image above is of the streetscape in and around a BRT station in Yinchuan, China and provides an illustration of the zoning provided for the right of way, station, general traffic, pedestrian crossing and the ancillary activities such as parking at the fringe zone



Activity zones around stations

# Park and ride should be provided at the outer ends of the corridors to encourage mode shift and reduce traffic (1 of 2)

4

Corridor design and management

## AART

## AART+

### Park and ride

- Park and ride should be provided at the outer ends of the corridors to encourage mode shift and reduce car traffic along the corridor
- According to *Auckland Transport's Parking Strategy*, there are currently c.5,500 park and ride spaces across the Auckland region with the largest single facility at Albany Station on the Northern Busway with 1,100 spaces
  - in recent releases, AT has also stated it would like to see another 10,000 park and ride spaces across the region by 2046. This would not only be in a series of locations along the Northern Busway to support continued access and growth of that spline route, but also at major facilities in Westgate in the west and Drury in the south (both of these planned to be over 500 vehicle capacity facilities). Others, of 300-500 vehicle capacity, would also be constructed at Smales Farm, and at locations outside the Northern Busway corridor such as Sunnyvale, Glenn Innes, Botany and as far south as Pukekohe
- For a city that has already invested heavily in the support of park and ride to feed into public transport corridors, it appears logical that the outer stations of the AART / AART+ options at the following locations should be considered as feasible park and ride locations:
  - Auckland International Airport
  - Airport Business District
  - Ascot
  - Mangere Town Centre
  - Favona
  - Mangere Bridge
  - Onehunga Rail Station
  - Hillsborough
  - Mt Roskill Junction

## Park and ride should be provided at the outer ends of the corridors to encourage mode shift and reduce traffic (2 of 2)

4

Corridor design and management

AART

AART+

*Park and  
ride  
(cont.)*

- The provision of key areas for park and ride access to the ABS would enable primed patronage for public transport with improved understanding of the needs of the traveller. The example below is from the Metro Orange Line BRT system in LA County, USA where it was identified that the 'last mile' issues for passengers were addressed by the provision of park and ride. This would resonate with some of the issues that are faced in Auckland, particularly in the areas to the south of the CBD and just north of Manukau Harbour, as this land lies between the western suburbs rail line and the southern line to Manukau City

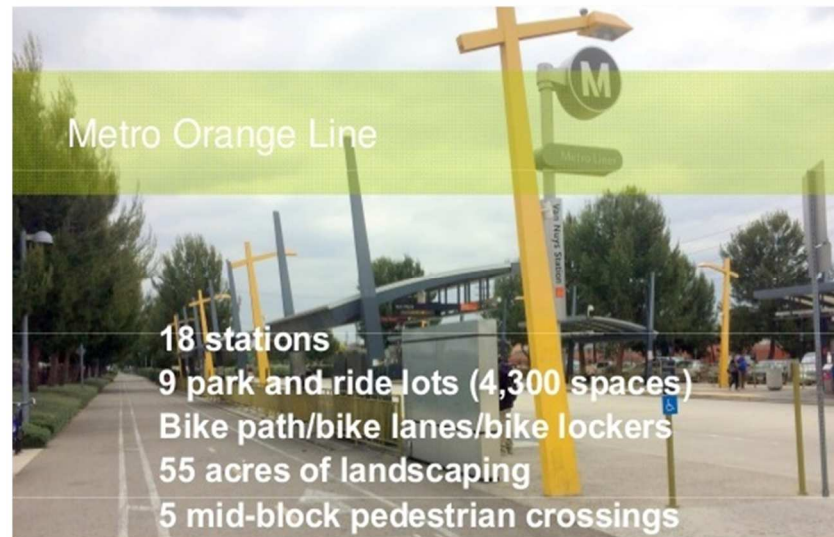

*The Orange Line in LA County, USA*

## Walkthrough of the 14 key design principles

---

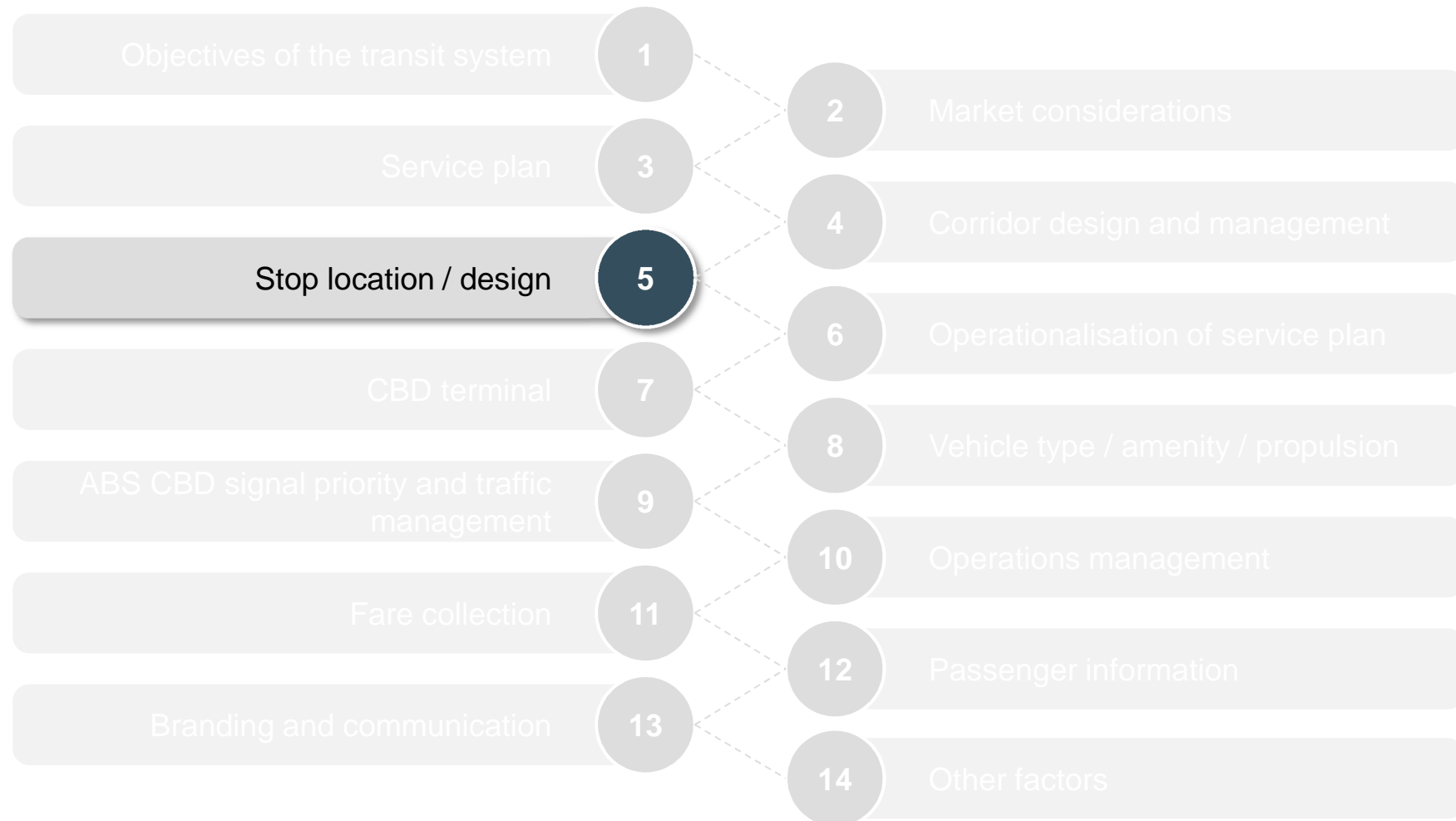

# The key elements of ABS stop location / design include flexibility, design and footprint

5

Stop location / design

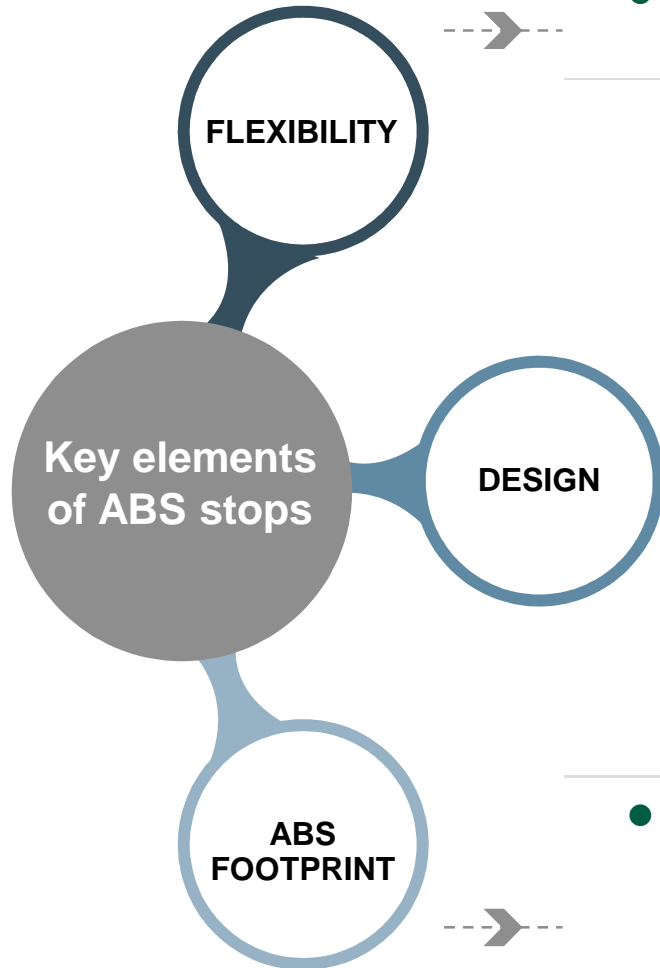

- The flexibility of the stop design (relative to the cross-section and longitudinally) is important

- The design of the stops has an impact on urban amenity – as good as any other best practice rapid transit stop. Key considerations include:
  - how people will get to stations if they are centralised stations
  - alignment of platform height to bus floor height, allowing for accessibility (i.e. optimising boarding / dwell times)
  - amenities at the stop
  - the need for off-board fare validation to provide HOP-only, cashless ABS services
  - dynamic passenger information (e.g. system messages about disruptions)
  - static information

- The ABS footprint can range between 13.7-18.7m in the cross-section, depending on whether:
  - a station is required and whether centralised stations with / without offset platforms or kerbside stations are used
  - there is a need for passing stopped vehicles

- Other key elements of ABS stops are more design-related matters:
  - maximum acceptable and desirable walking distances – walking distances between stations will vary due to the topography and prevailing weather conditions. For example, the ‘normal’ distance people are willing to walk to bus stops, which is typically 400-500m, i.e. a 5-10 minute walk, may not be applicable in Auckland
  - determination of any existing or parallel local services available (in almost all cases this is not the case)
  - speed and service objectives for the routes
  - availability of pedestrian infrastructure (e.g. sidewalks)
  - quality of pedestrian environment (e.g. trees, block spacing, store fronts, street furniture)
  - width of streets
  - topography
  - weather
  - customer demographics (e.g. elderly or disabled, hospital access etc.)
  - local conditions and expectations
- Where possible, stations should normally be located at major origins and destinations. Often, these are interchange locations at retail developments or major residential areas
- For the use of median stations, all of the ABS stations should be located at major traffic signal controlled intersections that allow for pedestrian access



## The station design blueprint for AART and AART+ consists of flexible designs and locations

5

Stop location / design

### AART

### AART+

- There are a number of options that can provide the quality stations required for the ABS. There is also considerable flexibility of the options that provides for all corridors to be dealt with or treated independently on the basis of their required design criteria (e.g. mixed traffic, ROW with other traffic, PT Mall, constrained corridor, limited footpath, limited intersections etc.)
- Coupled with the considerations of the station type and location are also the vehicles and operational considerations of the size and therefore how the vehicles and stations 'dock'
- The ABS stations will need to be designed to take into consideration, or provide the framework to develop, the following principles:
  - the stations will be configured to support efficient boarding and alighting of passengers
  - the stations will provide an off-board ticketing solution through an 'open' station environment
  - the stations should be recognisable as part of system as a whole. This will be achieved in part by station design and branding, which provides expression of local character within an identifiable ABS system
  - the stations will provide a safe and secure environment. Visibility of the stations within their wider context and sightlines into and through the station are key considerations together with CCTV, help points and on site security (if required)
  - the station design will be modular. This will allow the range of modular elements to be organised to suit to a range of station sizes, locations and demand

# Some of the ABS stations proposed along the two routes will be express stops and/or interchanges with other modes



Proposed ABS stations for AART and AART+

Ref. #	AART and AART+		Feasible park and ride locations	Interchanges with other public transport modes
	Dominion Rd route	Manukau Rd route		
1	Auckland International Airport		✓	Airport
2	Airport Business District		✓	
3	Ascot		✓	
4	Mangere Town Centre		✓	
5	Favona		✓	
6	Mangere Bridge		✓	
7	Onehunga Rail Station		✓	Onehunga Rail Station
8	Hillsborough	Royal Oak	✓ (Hillsborough)	
9	Mt Roskill Junction	Pah Rd	✓ (Mt Roskill Junction)	
10	Mt Roskill Shops	Green Lane West		
11	Lambeth Rd	Inverary Ave		
12	Balmoral Shops	Bracken Ave		
13	Milton Rd	Clovernook Rd		
14	Valley Rd	Newmarket Rail Station		Newmarket Rail Station
15	Tawari St	Khyber Pass Rd		
16	Dominion Rd	Auckland Hospital		
17	K' Rd			
18	Aotea Square			Aotea CRL* & Wellesley St bus
19	Victoria St			
20	Britomart			Britomart CRL* & ferry
21	Commerce St			Britomart CRL* & ferry

Key: Express stops

Note: \* City Rail Link

# There are four types of ABS station designs that could be used along different parts of the corridors (1 of 4)

## AART

## AART+



### Parallel offset median stations

- Parallel offset median stations are central stations that are part of a pair of stations at each location. This allows for reduced width in constrained corridors, while still providing for dedicated rights of way for each direction. The use of specialised vehicles that have multiple right hand side double doors for passenger boarding and alighting is necessary
- Each station (either the 2.0m wide version or the 2.5m wide version) will have the same systems and equipment. The stations will be designed to ensure that the quality and feel of the system are consistent along the route. Only minor changes may exist (e.g. ticket machines at the station, the number of validator machines), where they depend upon availability of space
- In relation to the layout, the figure below reflects a typical station, indicating the surrounds of the station and the access to the station from the traffic signal intersection. The roof extends over the station to provide cover for boarding / alighting passengers and at the entrance / approach for ticket machines

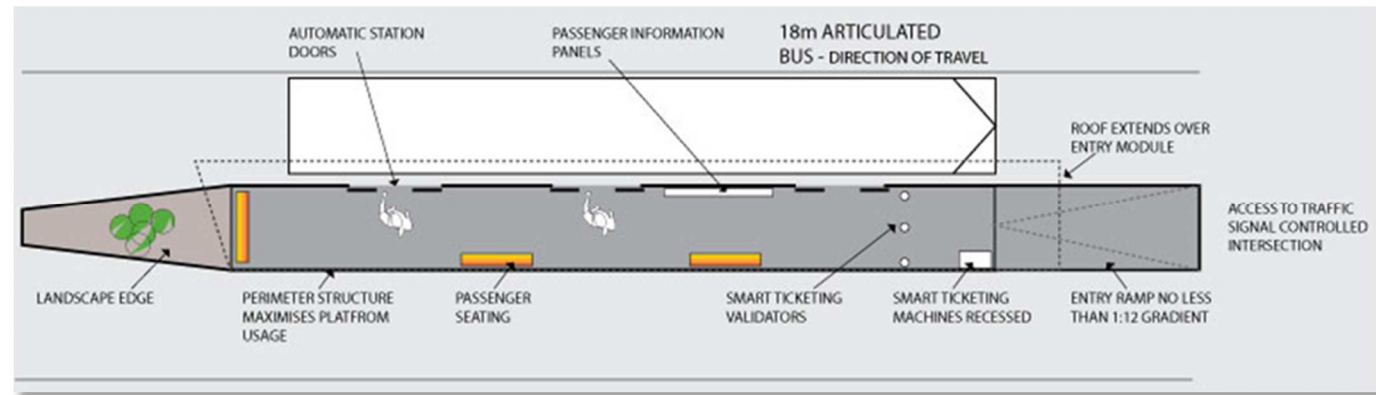
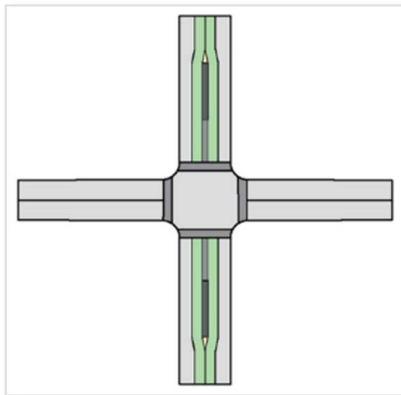

# There are four types of ABS station designs that could be used along different parts of the corridors (2 of 4)

## AART

## AART+



### Central median stations

- The use of central median stations is most practical for relatively unconstrained corridor widths and in sections that might be allocated as PT Malls. This is because it provides a dedicated facility for all transit passengers and provides for better station legibility in the streetscape. Specialised vehicles that have multiple right hand side double doors are necessary for median boarding and alighting
- The design of the tapers for this transition must carefully take into account the design speed for both the roadway and the dedicated right of way, and any unique handling characteristics of the buses being used
- Each station (of 3.0-5.0m width, depending on the demand capacity) will have the same systems and equipment. The stations will be designed to ensure that the quality and feel of the system are consistent along the route. The benefit of central median stations is that all equipment and facilities at each stop location are only in one location and thus cost savings would be expected with this facility type
- As with the parallel offset median stations, access to the station will be from the traffic signal intersection

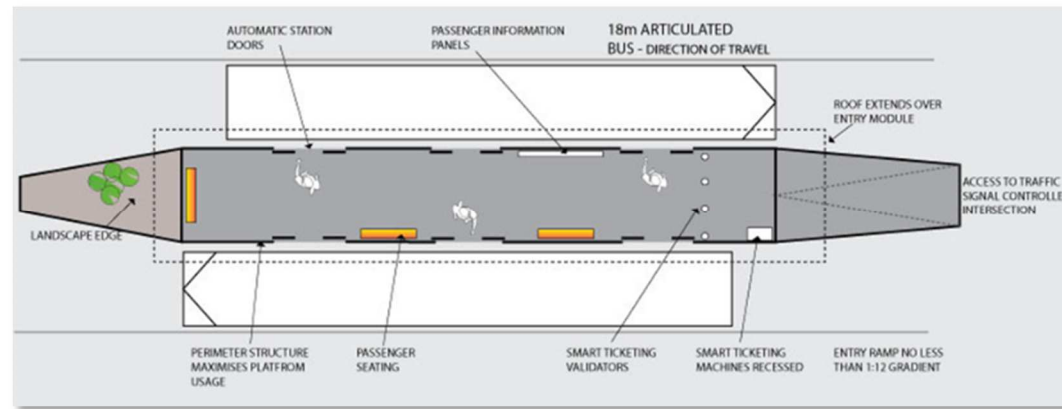
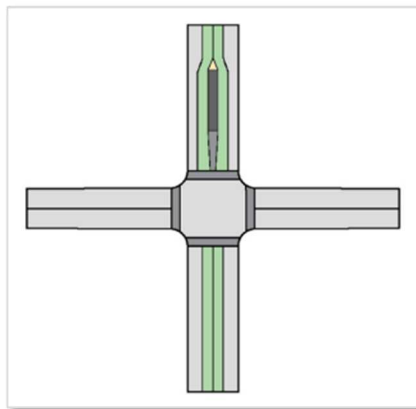

# There are four types of ABS station designs that could be used along different parts of the corridors (3 of 4)

## AART

## AART+



### Lateral offset median stations

- A lateral offset median station is part of a pair of stations at each location and can be used to access a central median right of way. This station type not only allows for reduced width in constrained corridors, but also provides access to the bus from the standard left hand side configuration, while providing for dedicated rights of way for each direction. The use of specialised vehicles is unnecessary, as passenger boarding and alighting is carried out via two sets of double doors on the left hand side
- Each station (either the 2.0m wide version or the 2.5m wide version) will have the same systems and equipment. The stations will be designed to ensure that the quality and feel of the system are consistent along the route. Only minor changes may exist (e.g. ticket machines at the station, the number of validator machines) where they depend upon availability of space
- In relation to the layout, the figure below reflects a typical station, indicating the surrounds of the station and the access to the station from the traffic signal intersection. The roof extends over the station to provide cover for boarding / alighting passengers and at the entrance / approach for ticket machines

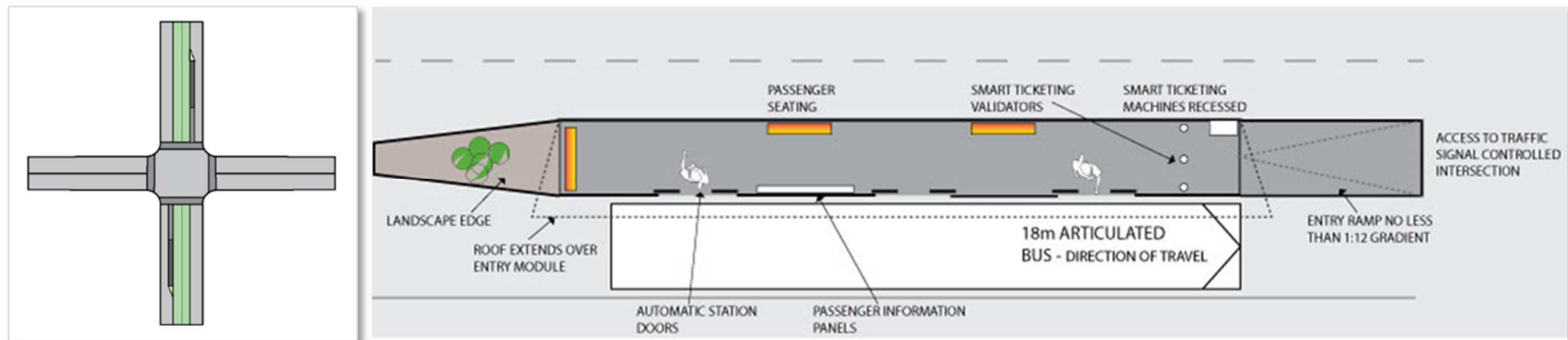

# There are four types of ABS station designs that could be used along different parts of the corridors (4 of 4)

## AART

## AART+



### Kerbside stations

- In the case of kerbside platform stations, the dedicated right of way will typically continue along the kerbside lane, with the general traffic (if any) maintained in the outside lane to accommodate the stations. Consideration should be given to how the platforms will be protected from general traffic accessing the dedicated right of way, both in the taper area and where general traffic is adjacent to the platform. Consideration should also be given to the allocation of space for the platforms in relation to the 'active edge' areas and the interaction with significant pedestrian numbers, such as on Queen St
- The stations will need to be 3.1m wide at an absolute minimum (2.875m for the shelter and 200mm offset from the kerb) to accommodate the shelter, platform and equipment or in the instance shown below, there would need to be an additional 1.2m minimum kerbside platform width for boarding and alighting
- Stations and platforms will be designed for level boarding along their lengths and the equipment will include seating, maps and route information, RTPI panels and ticketing machines

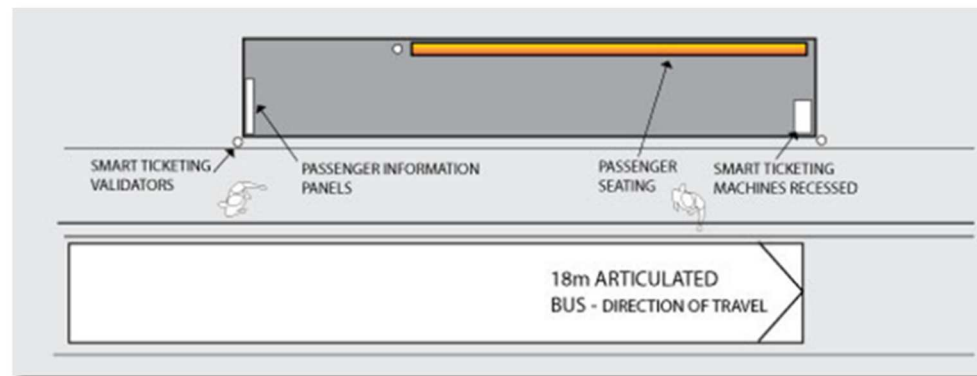
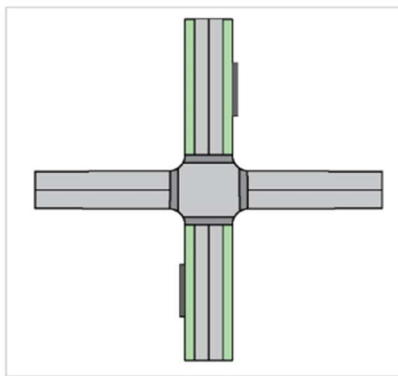

## Regardless of the station design, the platform height and docking systems should allow for precision and safety (1 of 2)

5

Stop location / design

### AART

### AART+

- For the design of the ABS, the vehicle design type considered should have a partially or fully low-floor, with the floor of the vehicles being 30-36cm high
- While some stations have been developed in Asia, India and South America to accommodate a boarding height of 65-90cm (mid to high floor), due to issues related to the right of way and other road services, there are also stations that are 30-35cm high (low floor)
- In Auckland, where the running way surface can be guaranteed, actively monitored and maintained as part of the project deliverables, it appears appropriate to suggest that an ABS designed corridor would be suitable to be designed for operating vehicle and platform heights in the 30-36cm range
- Ultimately, the critical factor is that a level boarding access can be provided for all customers to not only improve the accessibility to public transport, but also to reduce the dwell times for vehicles, where possible
  - platform height affects ease of boarding; raised platforms enable easier, more accessible passenger boarding and alighting by decreasing step-down distance and gap between vehicle floor and platform
  - level and near-level platform stops can also increase route efficiency, allowing vehicles to enter and exit stops more quickly

# Regardless of the station design, the platform height and docking systems should allow for precision and safety (2 of 2)

## AART

## AART+

- For level boarding, not only do the vertical distances of the vehicles / platforms matter, but also the horizontal (step) distances between the vehicle and the platform. Therefore, the use of a Precision Parking system for the ABS would offer a modular, extendible and configurable solution, which is made of a series of equipment and sensors arranged in the stations and in some cases on-board the buses, whose functionality and type of control can vary depending on the system needs
- The installation of the elements is very simple, which benefits both at the time of assembly and afterwards during maintenance. The 'Plug & Play' philosophy has been applied to minimise the errors of assembly, and reduce installation costs. In order to ensure the safety of all passengers (including the elderly, very young children and disabled users), the access systems need to provide a level boarding and alighting at the platform with a maximum of a 30-50mm gap between the floor of the bus and the platform. There are two feasible options to provide this outcome:
  - the first and most cost effective is to provide an external extension (outside of the station) to the platform that allows the bus to dock closely with the platform edge
  - the second is the use of a steel plate, fitted at the entrance and exit of the vehicle, to cover any gap between the platform edge and the bus
- When the vehicle arrives at the dock, the position system detects that a vehicle has arrived and has positioned correctly in front of the doors of the dock. With the help of a light signal (red lamp), configurable in colour and frequency, the bus driver will know the status of the process. Depending on the installed system, after the configured time and once the vehicle is stopped in a correct position, the doors will be opened by the bus driver. The objective of this system is to identify the vehicle and follow the bus within the dock. Using several sensors along the dock, the system will:
  - help the driver to position the vehicle correctly within the maximum braking area
  - identify the length of the bus and if there are several lengths of buses, avoid opening the doors of the dock that don't have a bus in front of them

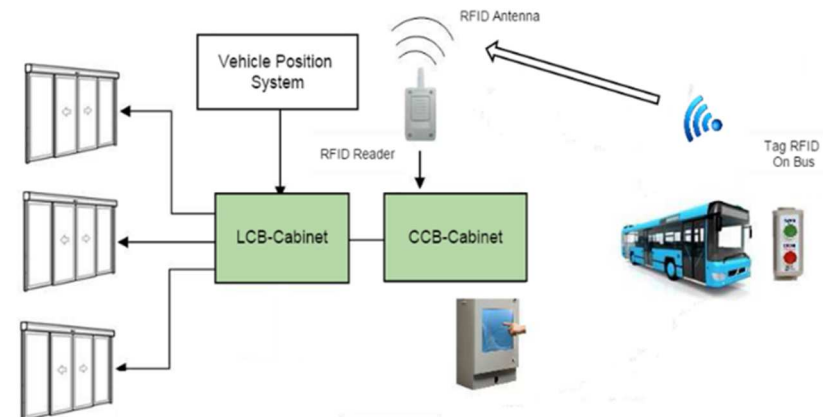

**Example of a precision docking system architecture**



# The internal station layout needs to ensure safe and efficient boarding / alighting (for non-kerbside stations in particular)

## AART

## AART+

- ABS stations will need to be designed to allow for safe and efficient boarding and alighting. This will be achieved through signs and markings in the stations
- For example, if automatic doors are chosen in the design phase, the passenger loading areas at the doors will require markings and signage to illustrate the 'clear zone' in front of the doors for efficient operation of alighting and boarding
- An area will need to be clearly defined for queuing for people boarding the buses and an area for alighting passengers will also need to be marked to allow for alighting first and boarding second

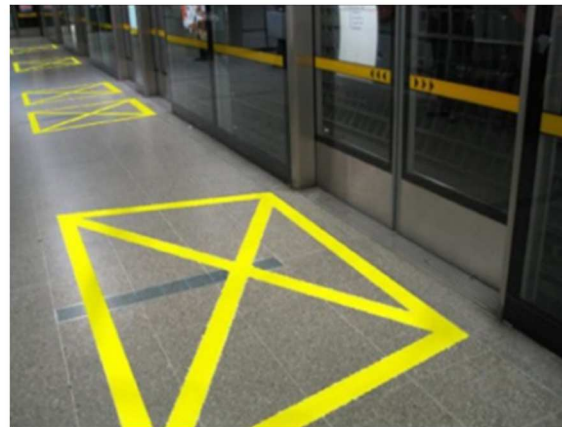
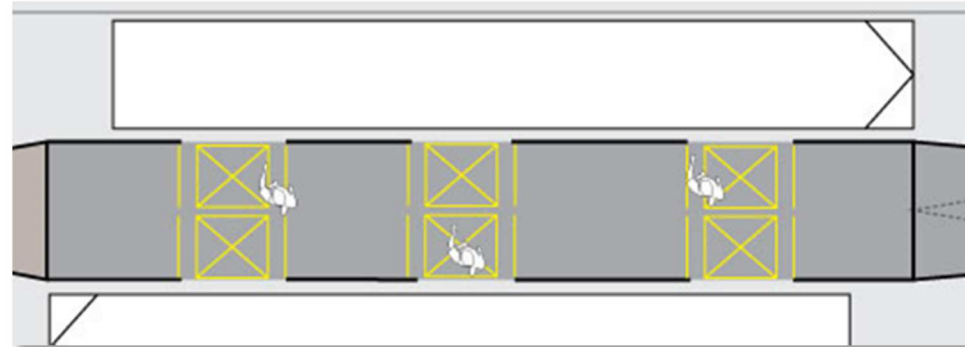

## Both AART and AART+ will require a number of ITS and ABS station equipment provisions

5

Stop location / design

### AART

### AART+

- The ITS and equipment at each ABS station should be linked to the fibre optic network through a 'local server'. The Operations Control Centre should send a variety of video, audio and text based information directly to the station, or the information / announcements should be locally generated by staff at the station
- The equipment details are proposed as follows:
  - the Real Time Passenger Information (RTPI) system will be linked to the Fleet Management System (FMS). The FMS will be linked to the GPS and provide ABS vehicle information in relation to the expected arrival time of the buses (northbound and southbound)
  - CCTV will be provided at all stations for monitoring and management of the stations. It will be provided by either one or two cameras mounted in the roof of the station and allow the maximum viewable area. All data will be viewable from the operations centre in real time and/or recorded and stored for a specified time period
  - if automatic doors are chosen, these passenger automatic doors will be located at the threshold of the station platform. There will be two or three automatic doors installed (depending on the vehicles that dock with the station), which will open following completion of the ABS vehicle 'docking' with the station. The doors will not open unless an ABS vehicle is present, and will close following the ABS vehicle doors' close procedure. No decision has been required for (or preference given to) any type of station doors (i.e. full automatic / half doors or just a barrier)
  - the ticket validator may differ depending on the size of the station but there will be a minimum of three validators at each station. The validators should operate with AT HOP cards and Near Field Communications (NFC) devices
  - the ticket machine will allow purchase of new smartcards or 'recharging' for the monthly pass and 'pay as you go' smartcard. This system will require online access at all times to assist with credit card verification and smartcard distribution. There will be one ticket machine per station; however, this may be reduced
  - the Help Point is a Voice Over Internet Protocol (VOIP) system that provides customers with the ability to contact the operations centre and speak to an assistant. This can be done to provide ticket / journey information or provide assistance if an incident occurs (and call the police / ambulance / fire brigade). There will be one Help Point per station

## Walkthrough of the 14 key design principles

---



# A number of considerations need to be made when setting the service capacity standards for future ABS services

## AART

## AART+

- During peak periods in particular, service frequencies are usually greater than the minimum standards and are driven by ridership demand. Service capacity standards can be developed to guide the frequency of services based on expected or observed ridership levels, usually at the Maximum Load Point (MLP). These standards should be used to establish the starting frequency of the service, and thus to determine the initial fleet sizes
- In addition to the simple service plan proposed for AART and AART+ under the principle '3: Service Plan', the next stage of work in 2017 will need to include an assessment of APT ridership demand and make adjustments to the design and proposals to meet this demand and operationalise the outcomes. It should also aim to predict and determine when ridership is increasing sufficiently such that services should be made more frequent. Having a single headway for the ABS does not appear to reflect a reasonable set of assumptions related to the outturn operations of the ABS
- Considerations that need to be made when setting the service capacity standards for future services include the following:
  - vehicle type and vehicle configuration (e.g. number of seats, amount of standing space)
  - route length, speed and boarding and alighting times per station
  - future expansion for ridership growth
  - vehicle operations, management and maintenance and the contract durations (initial vehicle contract and vehicles set at 10 years)
  - drivers and driver training, in addition to the operators' contractual responsibilities throughout the 10 years to meet the objectives for drivers' performance (e.g. station docking accuracy, drive comfort, on-board amenity, passenger questionnaires and surveys etc.)
  - wheelchairs and other mobility accessibility devices on-board and at the stations
  - park and ride or kiss and ride facilities at the stations (or more likely at major interchanges)

# Inputs to the operational service plan for AART and AART+ have been proposed (1 of 2)

	AART	AART+
<b>ABS vehicle capacity</b>	<ul style="list-style-type: none"> <li>18m specialised, articulated ABS vehicles (100 persons per vehicle; 60 seated and 40 standing)                             <ul style="list-style-type: none"> <li>a sensitivity test will be carried out for 18m specialised ABS vehicles (120 persons per vehicle; 30 seated and 90 standing)</li> </ul> </li> <li>Double-decker ABS vehicles (100 persons per vehicle; 85 seated and 15 standing)</li> </ul>	
<b>Corridor speed</b>	<ul style="list-style-type: none"> <li>Stop to stop travel time based on distance for the CBD section (Britomart to SH20) with an average travel time of 25km/hr</li> <li>Stop to stop travel time based on distance for the SH20 section (SH20 to the Airport) with an average travel time of 55km/hr</li> </ul>	
<b>Station dwell time</b>	<ul style="list-style-type: none"> <li>Dwell time at stations in the CBD corridor = 30 seconds</li> <li>Dwell time at stations in the SH20 corridor = 24 seconds</li> </ul>	
<b>Service patterns</b>	<ul style="list-style-type: none"> <li><b>'All stops' ABS services</b> for Dominion Rd from Britomart to Mt Roskill Junction or all the way to the Airport, stopping at all stations for boarding and alighting passengers</li> <li><b>'Express' services</b> for Dominion Rd to provide faster access to the Airport. The express operations will act as peak hour supplementary services to 'all stops' services. These may only be justified when the passenger demand is high enough to support both types of services on the Dominion Rd corridor and operating at rapid transit frequencies</li> </ul>	<ul style="list-style-type: none"> <li><b>'All stops' ABS services</b> for Dominion Rd and Manukau Rd from Britomart to Mt Roskill Junction or all the way to the Airport, stopping at all stations for boarding and alighting passengers</li> <li><b>'Express' services</b> for Dominion Rd and Manukau Rd to provide faster access to the Airport. The express operations will act as peak hour supplementary services to 'all stops' services. These may only be justified when the passenger demand is high enough to support both types of services on the two corridors and operating at rapid transit frequencies</li> </ul>

# Inputs to the operational service plan for AART and AART+ have been proposed (2 of 2)

## AART

## AART+

### *Relationship with parallel conventional services*

- The ABS route and additional services on Dominion Rd (for both AART and AART+) and Manukau Rd (for AART+ only) are implemented as part of the new ABS service, but what is missing is how to modify parallel conventional services (including removal / reduction of the parallel service, or keeping it as-is)
- In developing AART and AART+, several factors were considered:
  - ridership and potential for new ridership in the corridor
  - station / stop spacing
  - transfer convenience / demand
  - congestion on parallel streets and highways
- If all parallel services are to be removed, then the ABS' service levels must be able to handle the passenger volumes currently carried by conventional services, in addition to any increases in ridership expected as a result of the new, more attractive ABS services

### *Interchanges*

- To maximise the advantages for the ABS and the integration of the New Network services with the ABS, the existing and proposed New Network may need to be modified to reflect the future expansion of the ABS. These modifications may include the following:
  - route diversions to ensure that each route intersects the ABS in at least one location where passengers can transfer conveniently at a station
  - route diversions where the arterial route may actually use a section of busway or ABS corridor for a portion of its route
  - route extensions along a busway section or ABS corridor to take advantage of the faster operating speed, and to connect passengers on feeder and arterial routes to more transfer opportunities
  - the elimination of route sections where bus services can be replaced by walk-in access to an ABS station
  - service planning and schedule changes to provide for 'timed transfers' at the major interchange locations

## Walkthrough of the 14 key design principles

---



# The depot and layover terminal should be provided within or close to the airport zone for both AART and AART+

7

CBD terminal

## AART

## AART+

- There are a number of ways in which the lack of terminal space in the CBD could be resolved for the ABS:
  - exploring the potential for through-running (i.e. north and south)
  - exploring opportunities to develop off-street bus terminals, including within private developments
  - running routes as 'outer-terminal to outer-terminal' and treating the CBD 'terminal' as a mid-route stop (e.g. 'Airport to Airport via Britomart' as opposed to 'Airport to CBD'), avoiding scheduled layovers in the CBD
  - having minimal (i.e. near zero) stopping time in the CBD and having layover outside the most congested core
  - utilising multiple streets for the ABS in the CBD
- In the preferred option for both AART and AART+ it is proposed that the services operate as 'Airport to Airport via the CBD' and as such the location of the depot and layover terminal can be within or very close to the airport zone rather than the downtown / Britomart area
- There will be provision required for some relatively minor layover and feasibly driver changes in an emergency and this will be accommodated in Commerce St
- Within the service planning for the routes it is not the intention that the vehicles will require more than two to three minutes layover prior to re-joining the route for the return service; however, to ensure that there is sufficient space allocated there will need to be 50m of space within Commerce St. This would provide sufficient space for up to two 18m vehicles or three double-decker buses and would also allow for the possible use of Commerce St as a drop off / pick up for the express services if it was deemed necessary to split the operations of this service out of the Queen St stations
- Considering the existing situation on Commerce St, the block between Galway St and Tyler St would provide 60m of space and would be suitable for the requirements of the ABS



## Walkthrough of the 14 key design principles

---

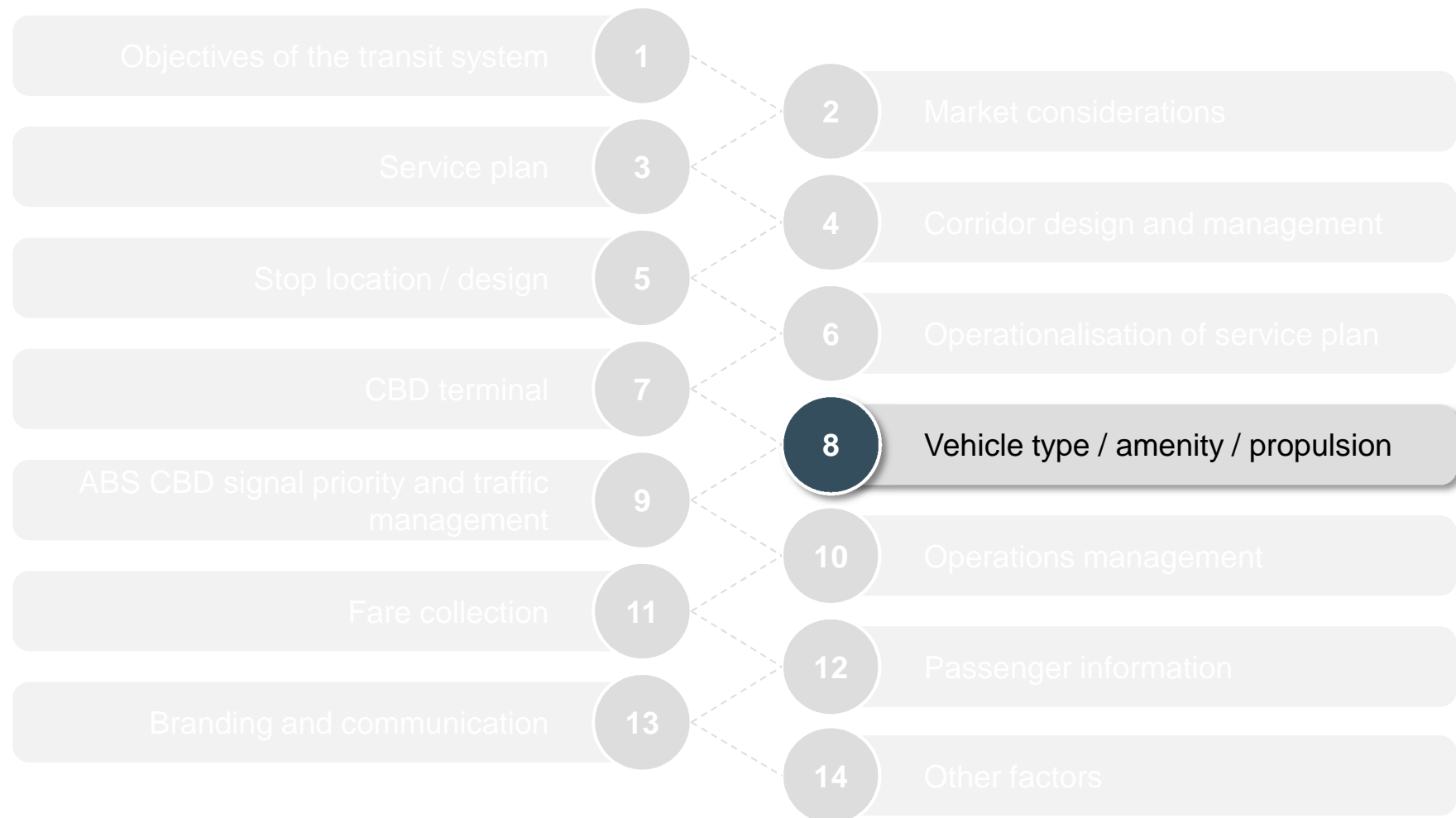

# A mix of articulated and double-decker vehicles are proposed for AART and AART+

8

Vehicle type / amenity / propulsion

## AART

## AART+

- In a stated preference experiment conducted by the University of South Australia in 2011, four passengers per square metre and no more than 15 minutes of standing time were deemed 'tolerable'. It is believed that the level of tolerance to crowding by passengers from Australian metropolitan cities and those from Auckland will be relatively similar
- This level has been adopted for the 18m articulated bus and the double-decker 12m bus that are being considered for operation in the service corridors for AART and AART+:
  - 18m specialised, articulated ABS vehicles (100 persons per vehicle; 60 seated and 40 standing)
    - a sensitivity test will be carried out for 18m specialised ABS vehicles (120 persons per vehicle; 30 seated and 90 standing)
  - double-decker ABS vehicles (100 persons per vehicle; 85 seated and 15 standing)



*Existing New Network double-decker buses operating in Auckland*

# There are various examples of buses with high visual amenity operating around the world

## AART

## AART+

- The images below illustrate a number of examples of the visual amenity of existing buses and the feasible options for the future of bus vehicles



*New Routemaster operating in London*



*New Wrightbus operating in Hong Kong*



*New Wrightbus 'Streetcar' 18m articulated vehicle operating in Las Vegas*

## Different internal configurations should be considered for different service types under ‘high-end rapid transit’

8

Vehicle type / amenity / propulsion

### AART

### AART+

- Service planning and internal vehicle layout for the ABS should reflect the parameters stated by the University of South Australia in 2011, with appropriate margin to allow for variances. Different internal configurations will need to be considered for different service types under the category of ‘high-end rapid transit’:
  - express services (e.g. virtually all seated as the distances are normally longer, as opposed to the urban routes where the journey time and distances are much lower)
  - articulated buses (with higher proportion of standees) for urban core routes, but using the same level of customer service of four passengers per square metre and no more than 15 minutes of standing time but considering longer term proposals for the urban core that might better serve a service plan in the CBD that is much more intensive
  - different vehicles may be assigned to the peak and off-peak, with the use of much higher capacity services in the peak and more standard vehicles in the off-peak period. This would require a phasing of vehicle types, operations and propulsion in an effort to mirror the demand requirements throughout the day. If larger vehicles (24m long) with peak loading capacity over 200 persons need to be introduced, changes to the axle loading legislation will be required and different standards may need to be applied for the customer services in relation to the proportion of standing vs. seated for the urban core routes; however, no change will be needed for the four passengers per square metre max crowding level
- Whichever type of vehicles, the broad design parameters will include:
  - number and width of doors (as can be seen in the images on the previous slide, the 18m articulated vehicles will be able to facilitate three double doors, in the case of the London Routemaster, the 12m double-decker bus can also provide three double doors and the 24m articulated vehicles can even have four double doors)
  - internal movement in the bus for very efficient alighting / boarding
  - ambience / climate control / WiFi / colour / lighting
  - designed for smooth driving (linked to propulsion systems) – ride quality / smoothness / noise

## There will be regular opportunities to purchase new and cleaner technologies for the ABS (1 of 2)

8

Vehicle type / amenity / propulsion

### AART

### AART+

- Bus technologies including propulsion systems will evolve over time; specifically with respect to the use of hydrogen fuel cells. The world's first double-decker hydrogen-fuelled bus, manufactured by Wrightbus, will be trialled in London during 2017 and the London mayor has pledged to stop buying double-decker buses that run purely on diesel from 2018 (as part of his drive to clean up the UK capital's air)
- The fleet replacement program provides regular opportunities to purchase new and cleaner technologies as they become market-ready
- Vehicle technology can be independent of the BRT infrastructure (i.e. there are no retrofit issues). For example, the ABS can be refined to include the phasing in of autonomous vehicles as trials and pilot schemes in Europe, Asia and Australasia are completed:
  - Mercedes-Benz's CityPilot autonomous bus technology completed a real-world, long-range test drive on the streets and highways of the **Amsterdam, Netherlands** this year. These autonomous buses successfully followed a 20km Bus Rapid Transit route between Amsterdam's Schiphol Airport and the nearby town of Haarlem. Regulations still require a human operator to sit behind the wheel in case of an emergency; however, the vehicles' intelligent systems make the driving decisions for the creation of a much smoother ride for everyone. Because the bus is connected to the city network, it can also communicate directly with traffic lights and other city infrastructure (i.e. the camera system can scan the road for potholes / obstacles, so buses can avoid rough patches on their next run or share that data back to the city operations centre)



Mercedes-Benz's CityPilot autonomous bus

# There will be regular opportunities to purchase new and cleaner technologies for the ABS (2 of 2)

## AART

- **Singapore's** Land Transport Authority and Nanyang Technological University's (NTU) Energy Research Institute will conduct a new autonomous bus pilot project in 2018. 12m electric hybrid vehicles will operate in the Jurong West region of Singapore, where the island's NTU is situated, and will initially operate between NTU and the neighbouring 'eco-business' hub, CleanTech Park (around a one mile journey). The trial is also considering servicing a nearby MRT station, which would extend the route to around a five mile round trip
- **Christchurch International Airport** will start testing the electric French Navya 15-person shuttle in 2017. The same driverless shuttle bus is currently being trialled along the foreshore in **South Perth**. This is not a standard size bus and is smaller at only 11 passenger capacity and a travelling speed up to 45k/h, although its average speed will be 25k/h. One significant consideration to note is that a number of changes would need to be made to the road network to accommodate the cars and legislation would have to be amended to remove the responsibility on a driver to be in control of a vehicle

## AART+



One of the autonomous buses to be deployed in the NTU / LTA trial in Singapore



Navya driverless shuttle

## Walkthrough of the 14 key design principles

---

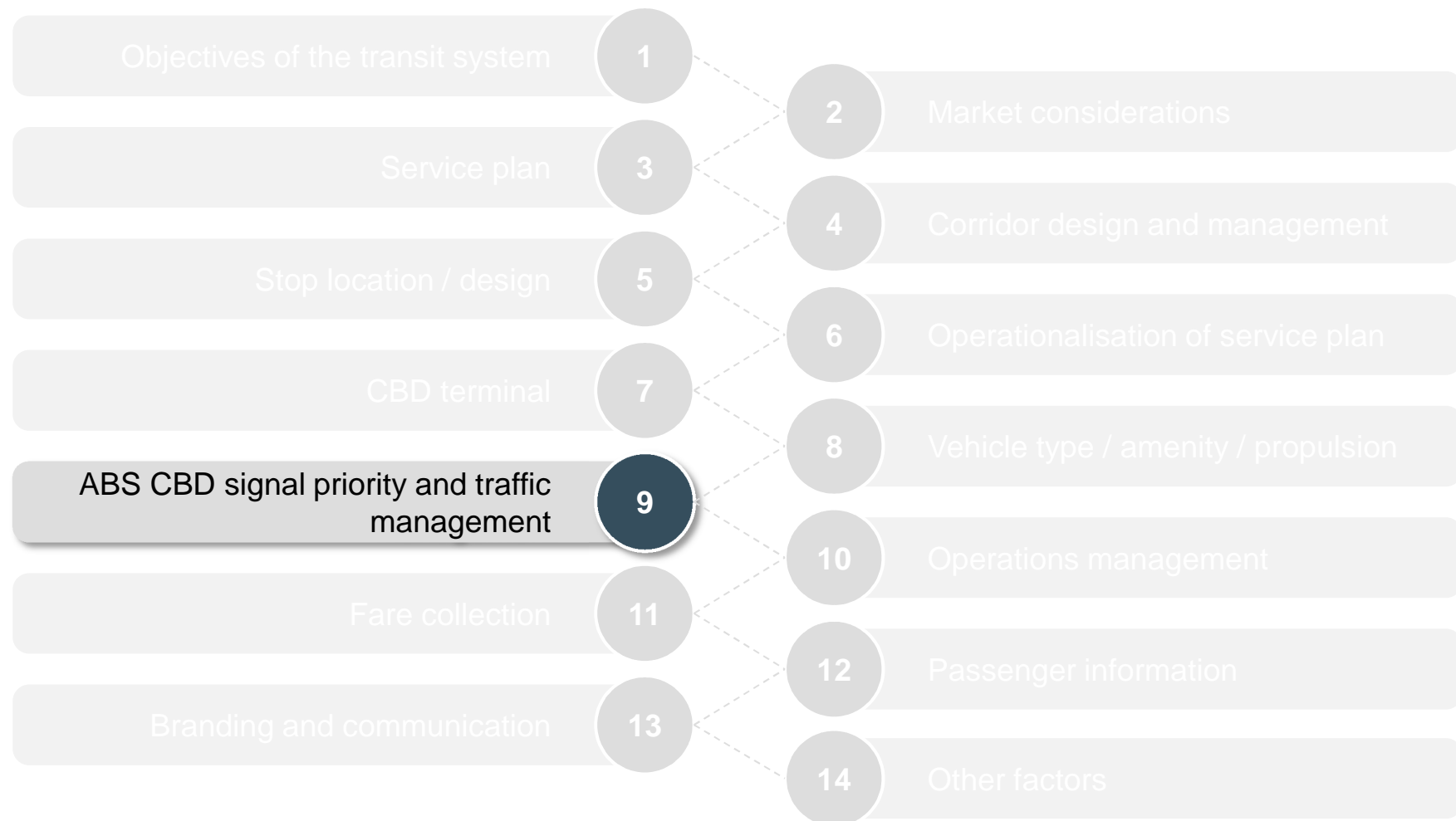

# The traffic signal priority system should be operating at all intersections along the ABS route...

## AART

## AART+

### Signal priority

- For the Traffic Signal Priority (TSP) system, all of the traffic signal intersections along the route should provide priority for late operating buses (or all buses as required – either conditional or unconditional priority)
- It should utilise ‘selective vehicle’ detection technology, linked to the Fleet Management System, to confirm the vehicle and the choice regarding the priority requirements
- This will be achieved by the extension of green time or actuation of the green light at signalised intersections upon detection of an approaching bus
- Intersection priority, in conjunction with dedicated lanes at all stations and all intersection approaches, means that the reliability of the ABS vehicle schedule can be safeguarded now and in the future. The diagram on the RHS illustrates the components of such a system, which would be installed at each of the ABS stations
  - the bus priority strategy and techniques need to be agreed with the city traffic authorities in accordance with traffic management policies
  - priority is provided to buses when it is required
  - the traffic control system has advance awareness of bus arrivals and can adjust the traffic cycle to minimise traffic disruption
  - if a greater number of buses need to be handled at junctions, platooning of buses can be used to reduce the number of priority events required

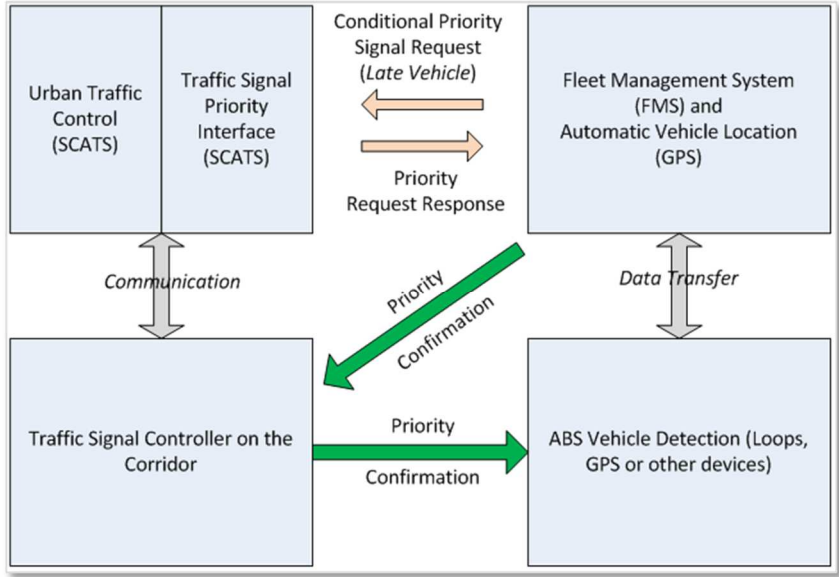

Traffic signal priority architecture



## ... providing active conditional priority for late running buses in both AART and AART+

9

ABS CBD signal priority and traffic management

### AART

### AART+

#### Vehicle detectors

- The cycle time and phases should be designed to minimise conflict with the ABS vehicle and general traffic. This will require: a loop detector to be installed in the pavement; or a detector device to be installed in the ABS vehicles; or other detector devices installed on the roadside to ensure provision of the priority process. For all CBD corridors in AART and AART+, the use of RFID, GPS or loops are proposed for the detection of ABS vehicles

#### Type of priority

- There are two types of priority for buses: 'passive priority' or 'active priority', where the classification mainly depends on the use of a vehicle detection system to determine the bus location. Nowadays, 'active priority' is very popular in the BRT signal priority technology space. Active priority can either be unconditional or differential / conditional
- **Conditional bus priority** is proposed for both AART and AART+, as is done for most newly developed BRT systems worldwide
- Priority will be provided for late running ABS vehicles only, with a centralised management system at the Operations Control Centre, incorporating loop vehicle detection (or other) at the intersections and the GPS system providing system redundancy
- **Late bus classification:**
  - the priority for buses and 'active' management of ABS vehicles will be programmed to deal with buses that are 20 seconds to 45 seconds delayed for a headway of two minutes
  - for headways of four to eight minutes, the classification of a late bus may alter to be buses that are 30 seconds to one minute delayed, which represents c.15-40% delay for that individual bus and for that section of operation. Therefore, the bus driver will be informed that the bus is late at 30 seconds and informed to make up the time during the station to station running. However, at 45 seconds to one minute delayed, the FMS will inform the TSP system that the bus is 'late', and therefore the late operating bus will be provided with priority at the traffic signal controlled intersections to enable time recovery
- It is noted that all ABS vehicles will be operated on a 'headway basis' and therefore no schedule for arrival at each stop will be applicable. However, the Real Time Passenger Information system will provide the passengers with up to date arrival times for the next three approaching buses. For the on-board information systems, the RTPI on-board will inform the passengers of the arrivals at the next station and also provide information about the location of the bus in the corridor

# To ensure system reliability and redundancy, the signal priority controller requires two-way communications

## AART

## AART+

### Type of communication

- To ensure conditional priority for ABS vehicles, there will need to be a data transmission connection with high reliability between the traffic signal controller and the Operations Control Centre, as well as two-way communication between the traffic controller, the dispatcher and the computer systems on-board the vehicles
- When the traffic controller provides priority for the ABS vehicle or when there is significant congestion, the traffic controller needs to be synchronised in real time between the traffic controller and other ABS control devices, dispatcher and devices support information for driver etc. Therefore, the controller requires simultaneous two-way communications to ensure system reliability and redundancy:
  - fibre optic network linking the shelters and traffic controllers
  - wireless network GPRS / GSM service provider's mobile phone

### BRT signal aspects

- BRT traffic signals can be installed in the central median, where appropriate, to separately control ABS vehicles. In relation to the design guidelines, it is often accepted that the LRT or rail signals are used in the instances of BRT proposals as the signal aspect differs greatly from the existing standard traffic signal controllers. These specific traffic signal aspects contain the following:
  - BRT aspect – a white horizontal bar on top ('Stop' or 'Red'), an amber circle in the middle ('amber') and white vertical bar at bottom ('Go' or 'Green')
  - two aspect (red man-green man) signal (if any)
- Presently in NZ, through the AustRoads design standards, a bus signal may be installed to allow buses to go through the intersection in advance of general traffic, operating under a 'White B' phase. This has been achieved by introducing a bus signal aspect (i.e. White B as illustrated on the RHS)
  - this is a special signal phase that allows any bus to move ahead prior to other stopped traffic. This phase would typically be activated for a short period (three to seven seconds), usually immediately prior to the normal green phase for traffic travelling in the same direction as the queue jumping bus and desirably based on an actuation from the bus



BRT signal aspect



Bus 'White B' aspect

# A number of traffic management issues have been considered for AART and AART+ (1 of 2)

## AART

## AART+

### Traffic management

- Throughout the options development, the issues of traffic management in the corridor and at intersections have been covered in some considerable detail. The key points in relation to the traffic management include:
  - at all intersections, there will be a need to provide traffic signal control along the corridor, particularly where the ROW will be crossed. No uncontrolled movement across the ROW would be provided as there are safety and efficiency concerns that need to be addressed. Therefore, on the arterial roads where there are vehicles exiting properties, they will need to be left in and left out only and the vehicles will need to proceed to the next upstream intersection to U-turn
  - it is noted that the central ROW will have more opportunity to be 'managed' when it comes to the right turns from the corridor and the ability to have less impact on the left turns out of the corridor and the adjacent land use. In the case of the land use, the central ROW from Mayoral Dr to Mount Roskill Junction for both AART and AART+ will provide for a general traffic kerbside lane and will have a relatively easy solution for providing left in and left out for the land uses and prioritising for U-turns upstream
  - presently there are a number of intersections that have banned right turns from the corridor and these will be maintained in the future, at least at this strategic planning level. The 'existing accessibility' will be maintained wherever possible
  - one section that changes significantly will be the introduction of the PT Mall between Customs St and Mayoral Dr on Queen St. The existing Queen St corridor has already been heavily 'calmed' for general traffic in the past and therefore the expectation is that this level of traffic reassignment will be accommodated on alternative north south corridors in the CBD or external to the CBD
  - at the same time, the public amenity for walking and cycling would be improved as the only vehicles in the corridor would be the ABS vehicles and feasibly a small number of service vehicles for some of the local land use, which would be limited to outside the peak hours
  - the ABS stations will be designed to create a high quality streetscape with exceptional visual amenity and a sense of place and context for the corridor. This would include the provision of high levels of pedestrian accessibility to the stations through improved signage and through the design of a brand and brand signage that ensure the stations are equated with a rapid transit system

## A number of traffic management issues have been considered for AART and AART+ (2 of 2)

### AART

### AART+

#### Traffic management (cont.)

- because the changes to the corridor are in the north south axis, there will be a reassignment of trips into parallel corridors, which would be the case for any and all options that seek to create a rapid transit priority in this corridor and it would not be mode specific. Changes to the volumes of vehicles in the north south corridor will actually improve the east west movements at the intersections along Queen St (i.e. K'Road, Mayoral Dr, Customs St and Quay St) and the east west movements at the intersections along Dominion Rd (i.e. Mt Albert Rd and Balmoral Rd) as there are less 'conflicting flows' on the north south movements and this allows for greater green time for the east west
- there are high-volume bus corridors and termini for other main bus services, including northern, north-western and eastern services (all of which use the downtown area, some using Wellesley St and K'Road). However, it is considered that the provision of the ABS will better integrate and facilitate the function of the other services in the short, medium and long term with the requirement for some further operational service planning to meet the feasible isthmus changes to create more opportunity for feeder services to key areas along Dominion Rd
- the ABS can also provide for greater levels of support for the existing services in the Manukau Rd corridor (in the AART+ option) with the provision of dedicated kerbside rights of way in key areas such as Broadway and Khyber Pass Rd, and the inclusion of new bus signal gates on Khyber Pass Rd to better facilitate the shift to the right turn lane to Park Rd. Additionally, the focus on providing a high quality of interchange at Newmarket Rail Station and the feasibility of providing interchange to Grafton Rail Station (not presently included in the AART+ option) will mean that other services with through movements along Broadway and Park Rd / Grafton Bridge will have improved priority, reliability and amenity
- the proposal for the Broadway section of the corridor does have historic issues with the provision of on-street parking being a consistent point that has been protected by the Newmarket Business Association for decades; however, the introduction of high quality, dedicated bus lanes in this section will require removal of the on-street parking and the redistribution of this parking to off-street facilities. As there are significant parking provisions already in Newmarket, there needs to be a view taken to support the accessibility of higher quality bus public transport from the south (including Great South Rd) and from the north (i.e. CBD via Park Rd, Grafton Bridge and Symonds St)

## Walkthrough of the 14 key design principles

---



# Advanced bus will require active management, supported by an operations centre

- A series of prerequisites may be needed to establish the baseline for the developed Advanced Bus Solution (ABS) and for the overall consideration of long term operations and management for an ABS in Auckland
- Automatic Vehicle Location (AVL) systems is already one of the elements of any system that would be part of all bus and ABS considerations
- The development of an Auckland '**ABS Operations Centre**' would be required to manage, maintain and operate the **ABS** system (and feasibly multiple modes in the future). This would include:
  - Automatic Vehicle Location (AVL)
  - Fleet Management Systems (FMS)
  - Real-time Passenger Information (RTPI) systems
  - in-vehicle equipment (including vehicle On-Board Unit (OBU) and ITS components such as validators, driver displays and CCTV etc.)
  - equipment at stations / stops and terminals (e.g. RTPI, Audio announcements, ticket validation / top-up and single journey ticketing)
  - public transport signal priority – linked to AVL and FMS systems
  - interface with the traffic operations team at AT (network management and safety)

# Advanced bus information infrastructure needs to be designed following a range of criteria

- The ABS information infrastructure is required to be designed following an 'open' architecture with modular components and online functions, and must meet the following criteria:
  - **functionality:** The system has to ensure the functionality of the equipment and switches, calculation of vehicle location, data security and storage, and functionality of the centralised management system (e.g. fleet management, passenger information, audio and visual connections etc.)
  - **performance:** It must meet the information processing, storage and switching capacity for the components inside the system
  - **scalability:** The BRT information infrastructure will be expanded day by day, so when designing the system, the possibility of extending the hardware system, software and the functionality of the system must be recognised
  - **stability:** Information for the BRT system should have the ability to backup and fault resistance for both devices and transmission lines should be provided, bringing high reliability for the system, ensuring continuous running and making redundancy available
  - **manageability:** Information for the BRT system needs to be centrally managed to be able to monitor the performance and error handling of the system quickly
  - **cost effectiveness**
- Over time, the ABS Operations Centre could be integrated with, migrated to, or developed into a more comprehensive facility for the complete bus network in Auckland
- Optionally, the ABS Operations Centre could also provide the reservation and dispatching functions for 'last-mile connection services'

# The system infrastructure requires the system architecture to meet the demands of various components

The system infrastructure requires the system architecture to meet the demands of processing capacity, storage resources, bandwidth for the transmission of the following components and communication infrastructure:

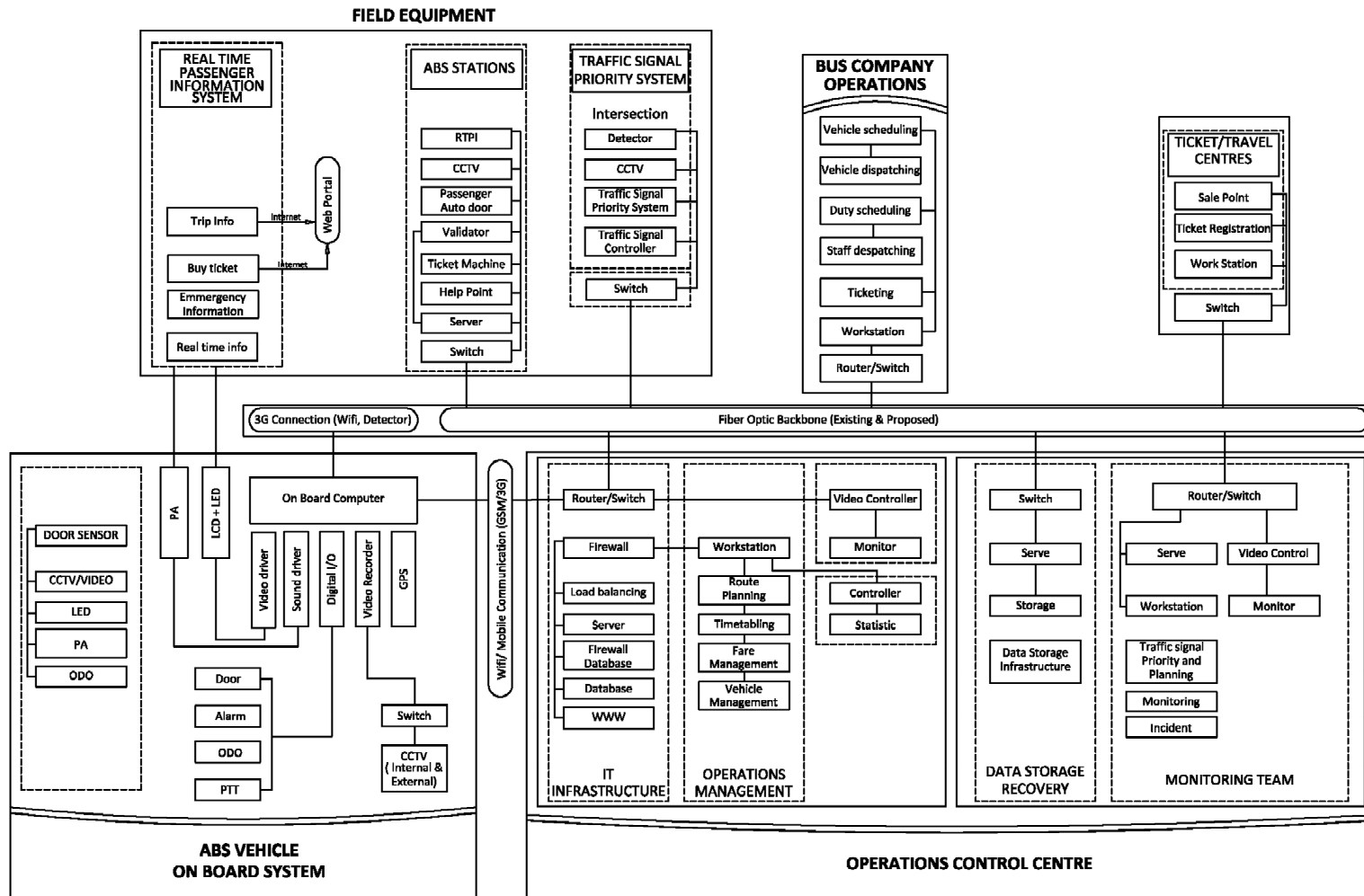



## Walkthrough of the 14 key design principles

---



# Advances in transit payment are fundamental to driving operational performance and customer amenity

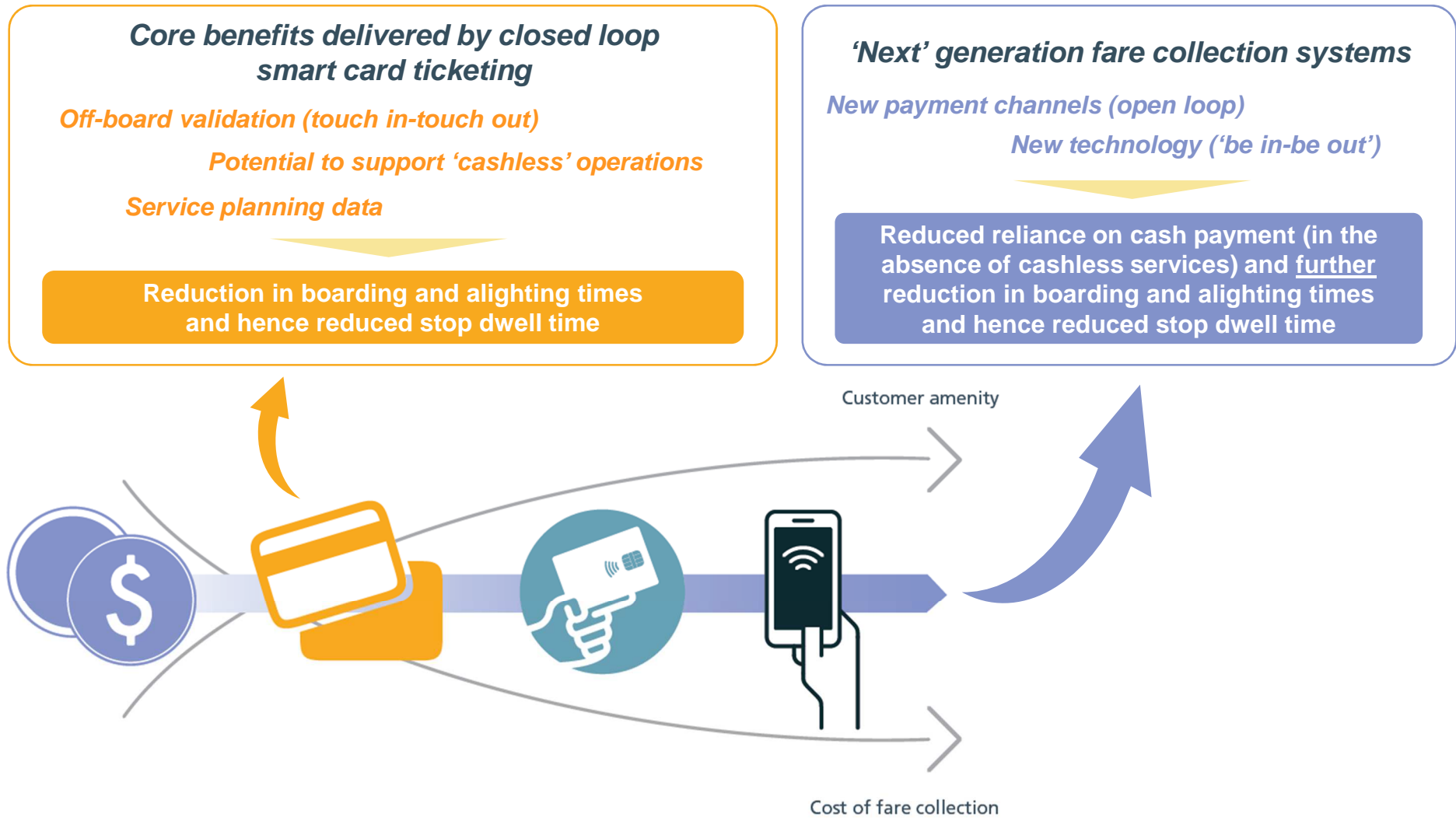

Source: L.E.K. Executive Insights

# The ABS should have an Automatic Fare Collection system

## AART

- To satisfy the diverse needs of passengers in Auckland and to encourage the increased use of intelligent public transport in the city, there is a need to continue to build upon the money that has already been invested by the city in the AT HOP Automatic Fare Collection (AFC) system
- The following criteria should be considered when developing an AFC system for the ABS:
  - the fare types must ensure service provision for different passenger types
  - the fare system must be interoperable for the whole public transport network
  - the fare system must have the ability to handle different fare policies with the changing environment considered by the Public Transport Operating Model (PTOM)
  - all AFC equipment at the stations must be connected to the station server, which will in turn synchronise the AFC configuration files as well as the sales / passenger entry / exit data files with the AFC servers at the Operations Control Centre and 'clearing house'
  - the design of the AFC will cover not only the necessary equipment, but also other system issues such as selling, clearing, recharging, transacting and authenticating, monitoring and security for the tickets
  - the AFC should be capable of acting as a communication interface with all equipment components to provide the following data recording:
    - the name of implementation software
    - transmission data format

## AART+

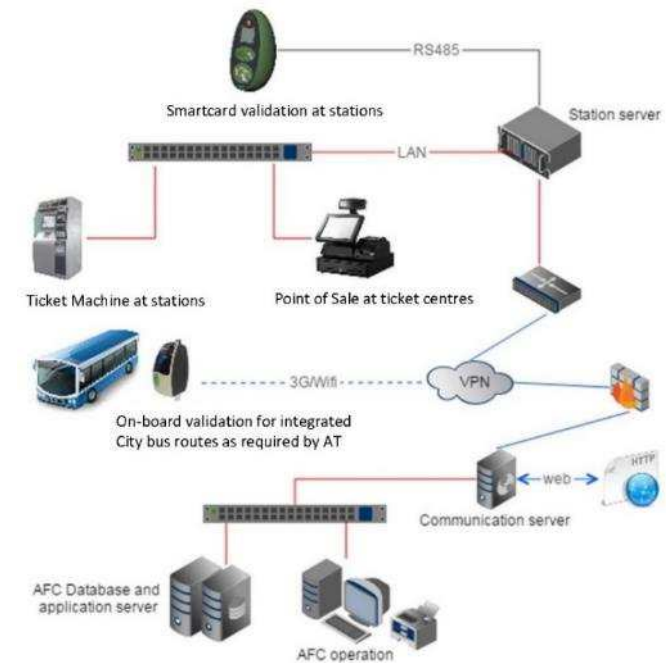

**AFC system architecture and components**

- Necessary information or specification of equipment components should be capable of being disclosed in order to secure the interoperability of devices. They should also be capable of being disclosed promptly based on the disclosing demand including the contents that are not described here
- The fare collection connectivity to the wider ITS system and in particular the field devices at the stations will consider using the platform design above

## The validators for the ABS should support Near Field Communication technology...

### AART

### AART+

- In addition to the use of contactless AT HOP smart cards, the validators for the ABS should also support Near Field Communications (NFC) through smartphones
- There is presently a significant shift within the transport industry towards NFC technologies
  - in February 2016, the American Public Transportation Association (APTA) announced a formal Memorandum of Understanding that will enable the two organisations, APTA and the NFC Forum to jointly educate the US transport industry on NFC technologies, supporting the needs of public transportation operators
  - recently, New York State announced a plan to support NFC payments for the 11 million user Metropolitan Transportation Authority
  - the UK Cards Association unveiled a framework to implement contactless payments, including NFC, nationwide on all forms of public transit
- NFC technology makes life easier and more convenient for consumers around the world by making it more simple to make transactions, exchange digital content and connect electronic devices with a touch
- A standards-based connectivity technology, NFC harmonises today's diverse contactless technologies, enabling current and future solutions in areas such as access control, consumer electronics, healthcare, information collection and exchange, loyalty and coupons, payments and transport
- NFC technology is supported by the world's leading communication device manufacturers, semiconductor producers, network operators, IT and services companies and financial services organisations. NFC is compatible with hundreds of millions of contactless cards and readers already deployed worldwide

## ... allowing customers to use their mobile phones to pay for their public transport trip

### AART

### AART+

- The ease of use and benefits of NFC are that commuters can use their mobile phone as a contactless transport ticket and have their transit pass stored digitally on their mobile phone, which can easily be topped up anytime, anywhere. During any journey, passengers simply tap their mobile device on an NFC reader at the ticket barrier or when boarding their bus
  - the added advantage is that there are opportunities to cover more varied payment options for transit tickets by having the Telco companies provide 'pay as you go' or even monthly tickets through direct billing to the mobile phone account
- In Singapore, a significant amount of research and development has gone into providing a transit function via debit and credit cards and this has culminated in a pilot scheme that will start at the end of 2016, allowing commuters to use 'contactless' credit and debit cards to pay for their bus and train rides. The trial will only be for those presently using Mastercard as the Land Transport Authority (LTA) announced a partnership with them in July 2016
- In the wider market, any credit and debit cards with contactless payment functions could be used to pay for bus and train rides in the future, eliminating the need for top-ups and also saving tourists the hassle of buying public transport tickets. Transactions would be charged directly to the users credit or debit bank account
- Currently, Singapore's commuters use CEPAS cards for public transport trips, which are issued by EZ-Link, NETS (Network for Electronic Transfers) or the LTA. Some banks also offer cards with CEPAS functions and cash is also accepted for bus fares. The new Account-Based Ticketing system LTA will be testing uses bank cards that are part of the EMV (Europay, MasterCard and Visa) Contactless Standards
- Currently, more than 10 percent of unique cards used for travel on London's bus and rail services are contactless bank cards and the remaining fare transactions use existing payment options, such as the Oyster card

## Walkthrough of the 14 key design principles

---

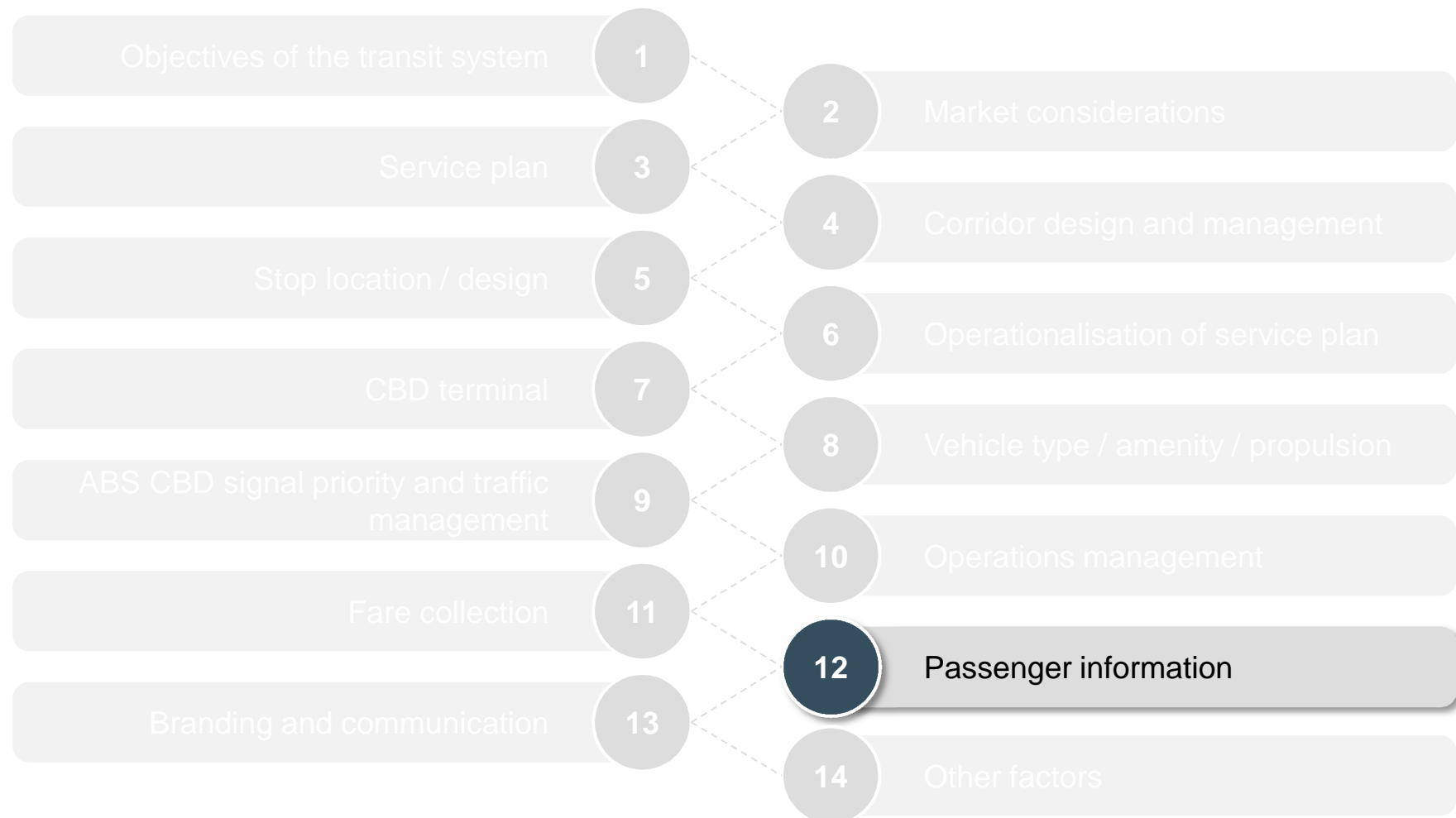

# Real Time Passenger Information systems will need to feature at stations and on-board the ABS vehicles

- The introduction of a Fleet Management System (FMS) and therefore a Real Time Passenger Information (RTPI) system will provide the ABS system with software-based management tools and field equipment to provide for the operational management of the ABS vehicle fleet in 'real time' (vehicle scheduling and dispatching). This will allow the operator to manage, monitor or amend the ABS vehicle fleet operations. The systems are often housed in a control centre that manages and monitors all aspects of the system operations
- The aim of a public transport FMS is to provide for simpler system implementation, and to enable the efficient management of the BRT vehicles and services by the BRT operations company. The key components to the system are:
  - planning units
  - operations, monitoring and control units
  - maintenance service units
- The RTPI system will provide the passenger with up to date and 'real time' data in relation to the arrival and departure times of the ABS vehicles on the route(s), the distances to the next destination (on board and at the stations), and any delays within the BRT system
- The RTPI is installed to help to reduce 'waiting anxiety' and to improve overall passenger information. The system will allow for passenger information displays to display text data, but will also be capable of audio functions duplicating real time passenger information, in order to assist the visually impaired (at the ABS stations and on-board)
- The in-vehicle displays can also show information about the connecting routes and interchange at the next stop, which includes the connections possible at each of the next three stops and the predicted arrival times of buses on the routes serving the next stop
- The RTPI displays (e.g. LCD displays) may include a station platform allocation line for multiple service routes or central median stations that have multiple directions in one station. Provision for dynamic allocation of platforms may be included with associated public address and other requirements. The functional requirements for the Passenger Information Display are:
  - a clear easily visible display in differing light conditions
  - accurate passenger information
  - catering for the visually impaired
  - linked to the city wide system (if applicable)



RTPI displays showing interchange options at next the stations

# The RTPI system architecture will provide a dedicated link to the fleet management and AVL systems

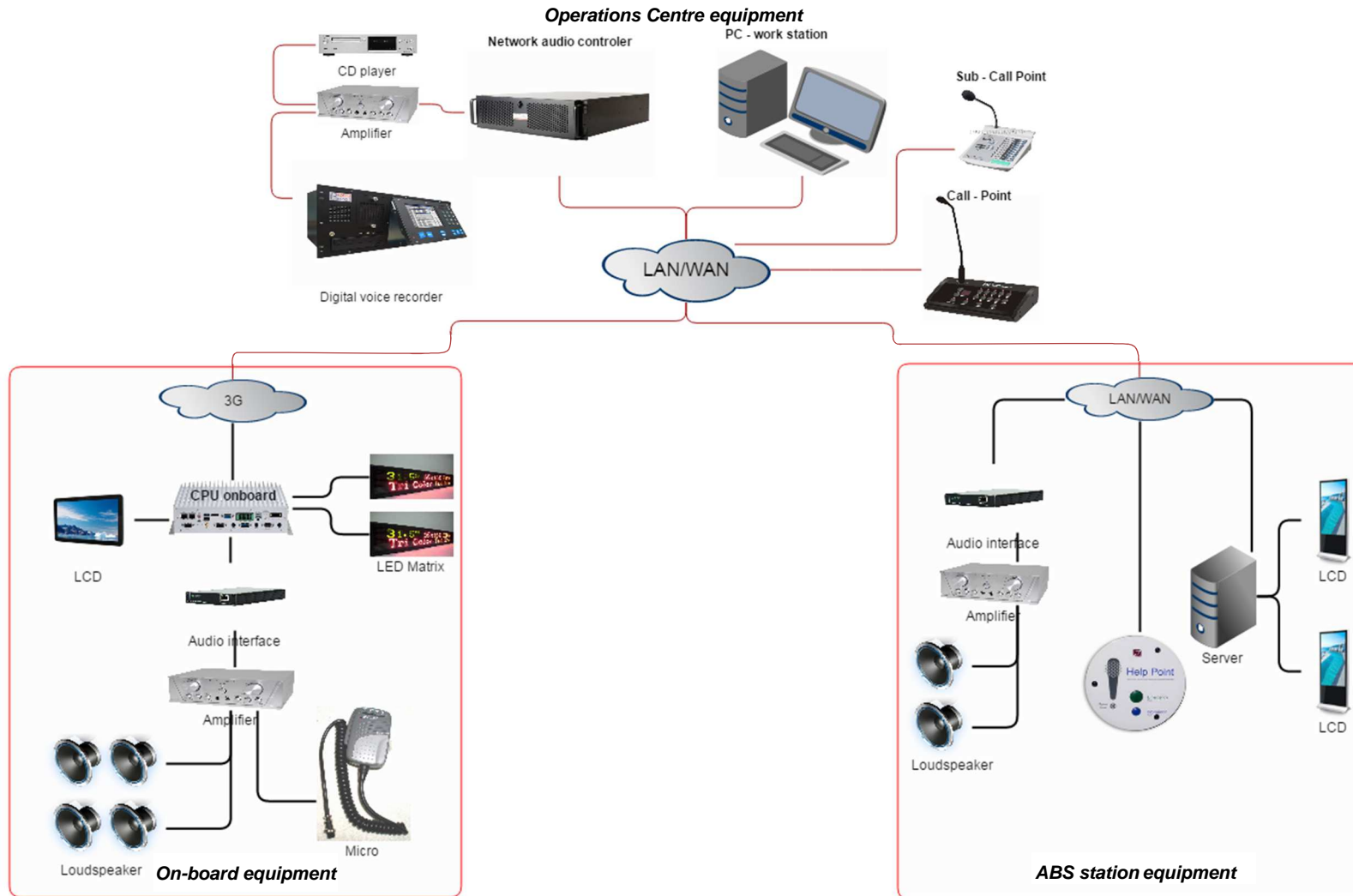



## Walkthrough of the 14 key design principles

---

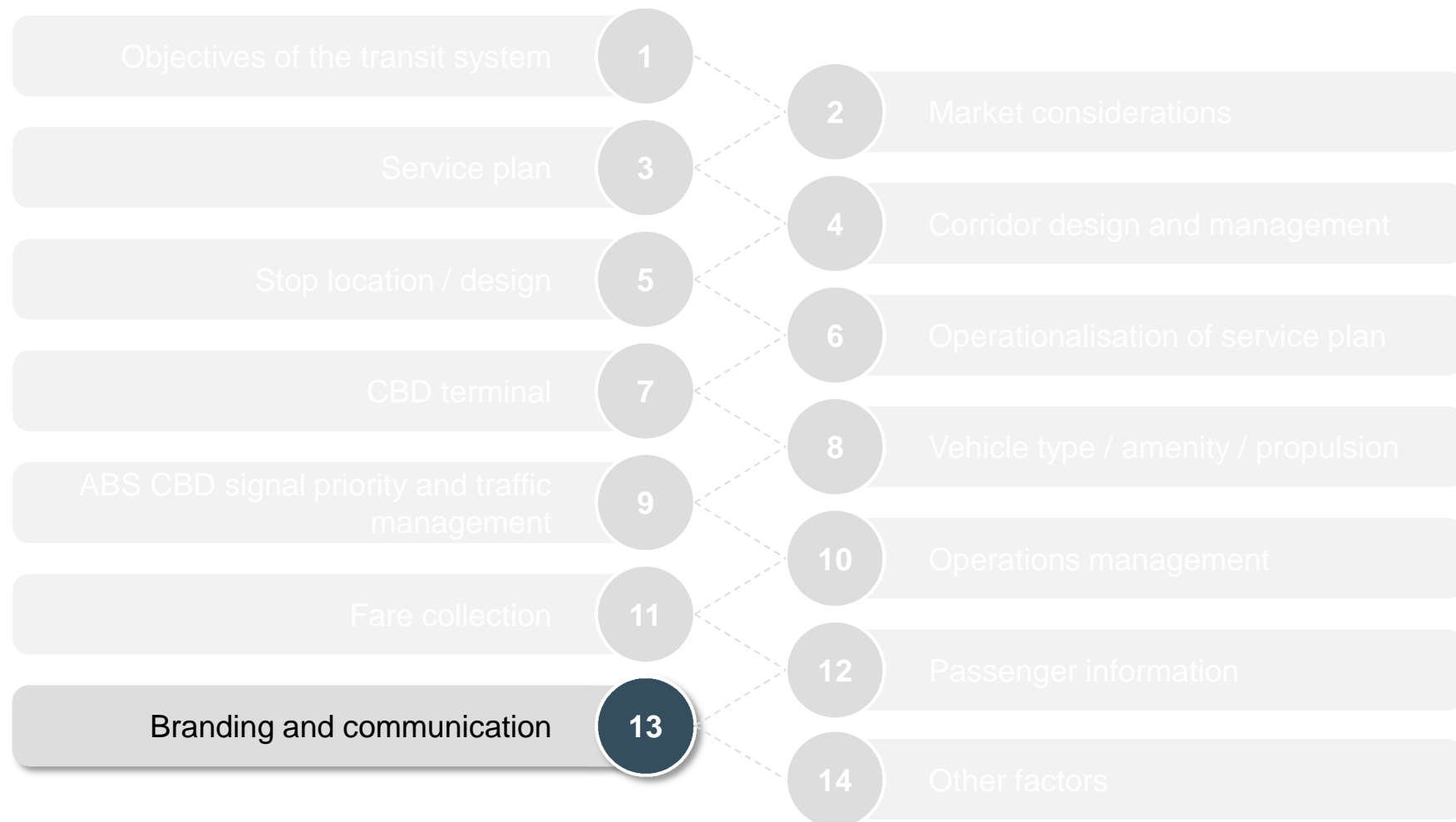

## *Project objectives*

- It is critical to clarify the required outputs to satisfy the requirements for the ABS, and define the inputs and resources of any proposed Public Relations, Branding and Communications exercise
- The **benefits of the ABS** need to be clearly communicated to the public, with the objective of promoting a continued shift towards more sustainable modes of transport, but also challenging the paradigm that bus transport is both a slower mode and lower on visual amenity than the options for rail or LRT. At the same time, the needs and attitudes of all transport system stakeholders, public officials, decision makers, the general public and the private sectors need to be communicated to the ABS system's planner, designers and operators. The communications therefore must be both ways – from the team to the stakeholders, but also from the stakeholders to the team – a 360 degree view
- The ABS needs to have a consistent brand identity (e.g. colour schemes and livery, logos, station designs and definitive brand throughout the buses and infrastructure), which sends a readily identifiable, clear and popular brand message to all users. In fact, there may be a scenario that means the ABS would have a distinct identity but that it remains consistent with the broader AT brand, hence an 'AT Metro BRT' or other such interface as part of the already recognised AT Metro brand

## *Branding and communication objectives*

- The determination of future communication objectives will be based upon the principles of AIDA (Attention-Interest-Desire-Action). In the initial stages of communication of the ABS, the objectives will focus on following:
  - the media will be introduced to the ABS system characteristics, strengths and benefits of ABS services
  - community awareness will be raised to create support for the ABS, strengthening their understanding and knowledge of the ABS and eliminating any prejudices / paradigms about the existing public transport services. This will allow for relations with strategic partners and national and regional government to be built

# There may be six phases for the ‘scope of work’ required for the branding and communications of the ABS (1 of 2)

## Delivery outline

### *Creative strategy and communications roadmap development*

Drawing up a communications strategy is an art, not a science and there are a myriad of ways of approaching the task. The communications strategy will be designed to meet the specific requirements of the ABS and look to define a programme with the knowledge that the implementation phases and other major elements of the project may be years away

### *Naming, name validation and tagline / slogan generation*

Both the brand name and slogan will be subjected to qualitative research among prospective targets to help identify the relative strengths and weakness of each. This will ultimately lead to a final name and slogan being developed alongside the art work for the logo

### *Branding, logo and identity option designs*

Different name studies for the ABS should be developed, with a shortlist created for submission to a qualitative research (in the form of logo designs corresponding to names for testing). The development of logo designs will be based on the name proposals for the ABS, and include the development of usage guidelines for the final approved designs for the livery of the buses and the stations design. For the brand identity, the development of secondary visual branding elements (i.e. colour palette, graphic / visual device, font package recommendation) and other corporate identity guidelines will be developed and include the development of the ABS ‘slogan’ and testing for public appreciation and iteration

### *Public relations and marketing plan*

The marketing campaign will be devised and implemented through a subsequent separate commission, to generate positive awareness and attraction to the ABS through the campaign. This will involve the preparation of advertisements and messages in relation to the ABS and the integration with the wider public transport network (all modes). User information and directions for informing the public and educating them about the ABS will be developed along with general encouragement to promote sustainable and integrated transport network solutions among Aucklanders. Special marketing strategies to capture the attention of special groups (e.g. businesspersons, schools and higher education facilities, woman, children, disabled etc.) will also be identified

# There may be six phases for the ‘scope of work’ required for the branding and communications of the ABS (2 of 2)

## Delivery outline

### Implementation

The output of the exercise will include but not be limited to the following – **Advertising** (e.g. print, radio, TV as well as social media and online campaigns, street signage and specialist group programmes such as schools and disabled society groups), **Press Strategy** (e.g. PR conferences for launch of services, regular updates to media, timely circulation of press releases) and **Launch Events** (e.g. events to launch the ABS, weekly activities post-launch to build ridership)

### Measuring & evaluating effectiveness of any outreach program

The public outreach efforts for promoting the ABS should continuously be evaluated to find the most effective approaches. The tasks might include: evaluation at the end of each outreach effort to gather information that can be used in future outreach efforts; keep track of how stakeholders heard about the ABS (media sources); conduct surveys (pre-, mid- and post-project) to learn which efforts worked better than others; and track the media coverage around the proposed ABS



Viva Ontario BRT – Branded as ‘Connecting Us’

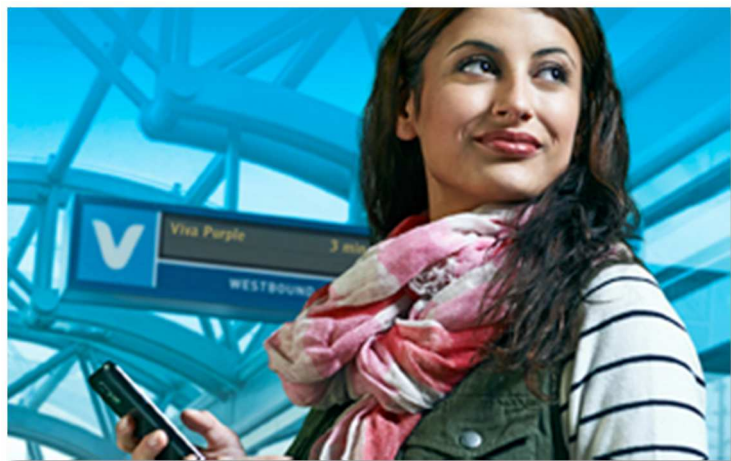

Development of the VIVA brand included trip planning and adverts

## Walkthrough of the 14 key design principles

---

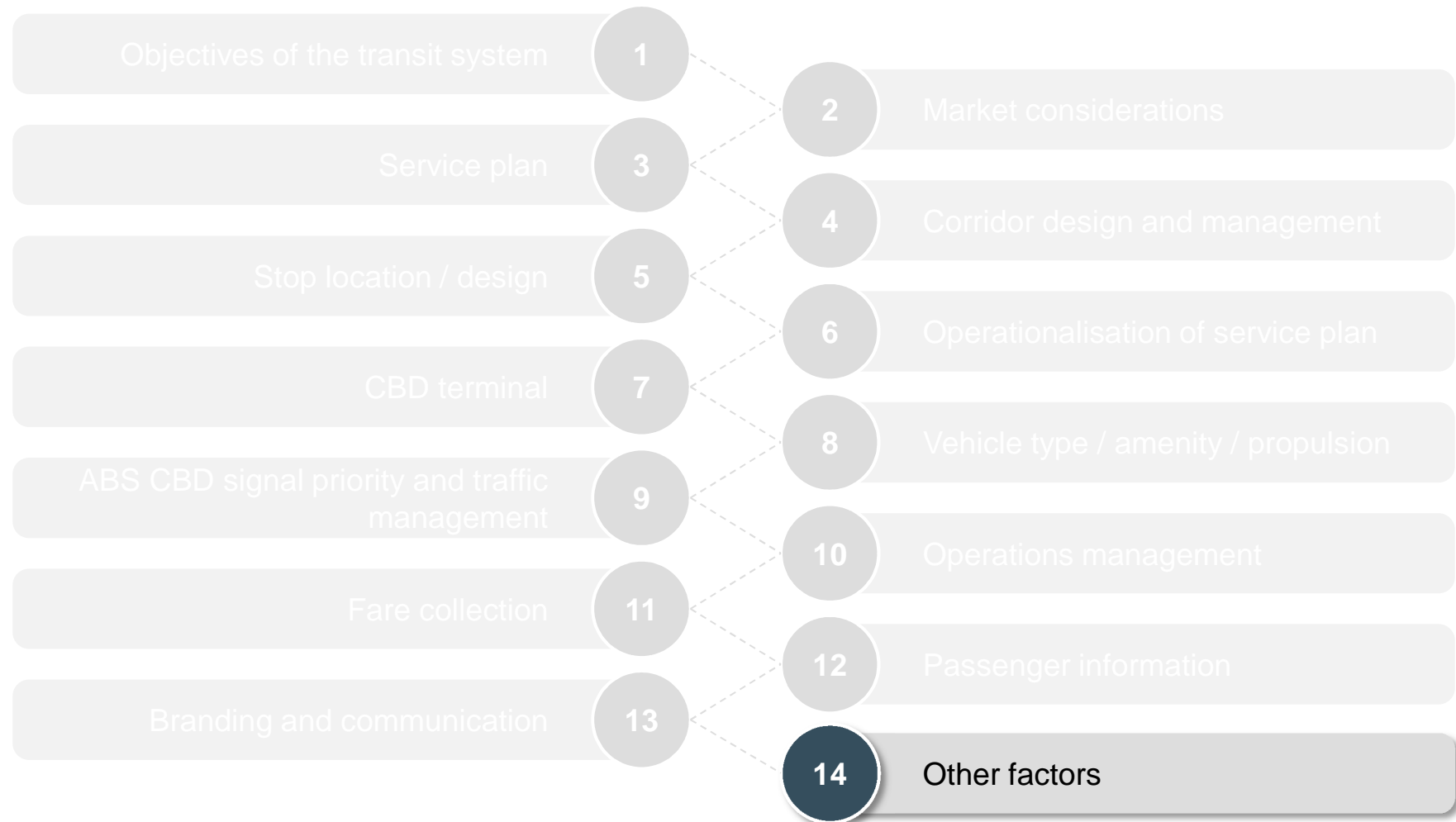

## The TransMilenio BRT system in Bogota operates in the central city area alongside pedestrians and cyclists

14

Other factors



Source: L.E.K. team expert interviews

# Buses operate alongside pedestrians and cyclists in Ljubljana along a corridor with high urban amenity



Ljubljana

Source: L.E.K. team expert interviews

## Denver's MallRide is served by buses and operates along a corridor with high urban amenity

14 Other factors



Denver

Source: L.E.K. team expert interviews



# The transit investment for the Cleveland HealthLine was leveraged to improve the urban form of the corridor

- The Cleveland HealthLine in Ohio is a BRT system, which opened in 2008 and carries c.16,000 passengers daily
- The city's main street, Euclid Ave was used as the main corridor for the system and the transit investment was leveraged to improve the urban form of the corridor

*"... The Euclid Avenue corridor had gone into a terrible state of disrepair but it was still the best connection from downtown to our University Circle area. [It] was an old tired street but that is changing quite a bit now. The objective of the project, in addition to putting transit in was to leverage the transit investment to also improve utilities, streets, sidewalks and kerbs ..."*

*Deputy General Manager, Engineering & Product Management, Greater Cleveland Regional Transit Authority (24 November 2016)*

- There was a strong economic development component to the project, with over USD \$6b of development being recorded along the corridor compared to the BRT program cost of USD c.\$200m

*"... The focus was on the transit component but there was also a strong economic component from the start... The HealthLine has been opened for eight years and is starting to mature. We have documented over \$6b of development (construction value) in the corridor and a couple of years ago we stopped keeping track. The HealthLine had a total program cost of \$200m and there has been a lot more development along the corridor... it is pretty high return ..."*

*Deputy General Manager, Engineering & Product Management, Greater Cleveland Regional Transit Authority (24 November 2016)*

- The BRT system has been a success, with people being attracted out of their cars. Ridership has also grown during the off-peak periods

*"... We have attracted people out of their cars and the BRT carries more people than our light rail system. This was already one of our best bus lines and over the years the ridership has grown by 60%. It is a 24/7 operation and we have had a tremendous amount of ridership growth in the middle of the day. This has been a pleasant surprise ..."*

*Deputy General Manager, Engineering & Product Management, Greater Cleveland Regional Transit Authority (24 November 2016)*



**Cleveland HealthLine station on Euclid Avenue**



**University Cancer Centre (\$350m development), constructed after BRT station locations determined**



**Cleveland Clinic Heart Centre (\$500m development), constructed at the same time as the BRT system**

# The Viva BRT system has been successful in providing transformation and intensification along the corridor

- The Viva BRT system in Toronto, Ontario has been opening in stages since 2005, with additional 'rapidways' (that run in dedicated rights of way), currently being developed and constructed
- From the outset, the function of the Viva BRT system was to connect three urban communities in the Toronto area, with a focus on transformation to high density development

*"... We envisioned three rapidly emerging urban communities sitting on the edge of the city of Toronto with a transformational vision to change them from being largely satellite communities to really coming into their own as large urban centres with changes in built form. This is a dialogue that took place well over 15 years ago and in terms of setting in place this transformation of going to high density, the connective tissue [required] was rapid transit..."*

*President, York Region Rapid Transit Corporation (1 December 2016)*

- BRT was selected for the project area based on its flexibility, constructability and phase-ability

*"... BRT rocks on the basis that it is a very successful instrument for delivering rapid transit in terms of flexibility, constructability and phase-ability. All of these things are worth gold. BRT done with the right attitude, a strong commitment to branding and delivering a rapid transit system, not a bus system brings you a completely different class of ride..."*

*President, York Region Rapid Transit Corporation (1 December 2016)*

- The BRT system has been successful in providing transformation and intensification along the corridor

*"... I wish you could see out of my window... these spaces could have been car dealerships and industrial buildings but we were steadfast in our vision of intensification. When we started this project 15 years ago, there were no high rises. So if someone is trying to tell you that you need LRT to attract investment, stand down on that argument, we don't buy it at all. There is no question that transformation and intensification has followed our system..."*

*President, York Region Rapid Transit Corporation (1 December 2016)*



**Viva BRT station with high urban amenity**



**Cycle, footpath and pedestrian crossing facilities alongside the Viva BRT system**



**Development along the Viva BRT corridor**

## Agenda

---

	<i>Page ref.</i>
● Executive summary	4
● Evaluation framework for the ABS study	15
● Review of current bus solution	26
● Summary of priority initiatives	48
● <b>Outline of ABS options assessed</b>	
- Overview of ABS options developed	72
- <b>Demand-capacity analysis</b>	<b>186</b>
● Assessment of ABS options	197
● Next steps	210

## Demand modelling assumptions and approach

---

- Two model runs for AART and AART+ were completed by JMAC based on the specification provided. No additional iterations / variations or alternative service planning options were tested due to the project time constraints
- **Key model inputs** for the ABS options included:
  - mode specific constant confirmed as the same for ABS and LRT (-5.6 minutes)
  - 18m articulated vehicle capacity 'capped' at 100 passengers
  - double decker vehicle capacity maintained at 100 passengers
  - average link speeds confirmed as the same for ABS and LRT (25km/hr between CBD and Mt Roskill interchange, 55km/hr between Mt Roskill interchange and Auckland Airport)
  - dwell times at stations confirmed as the same for ABS and LRT (30 seconds between CBD and Mt Roskill interchange, 24 seconds between Mt Roskill interchange and Auckland Airport)
  - 100% dedicated central median right of way for Dominion Rd, and expansion of the existing kerbside bus lanes accepting that there are areas of mixed operation for Manukau Rd
- The following **assumptions / model outputs** were used in the **evaluation**:
  - 2-hour peak data (both directions) were converted for the 'peak hour' using a 0.6 multiplier
  - boardings (both directions) in 2046\* AART = 15,571 AART+ = 25,394

Note: \* No-crowding model runs were used. Boardings refer to ABS vehicles only

# The AART 'express' services have a travel time of c.40 minutes between Britomart and the Airport and vice versa

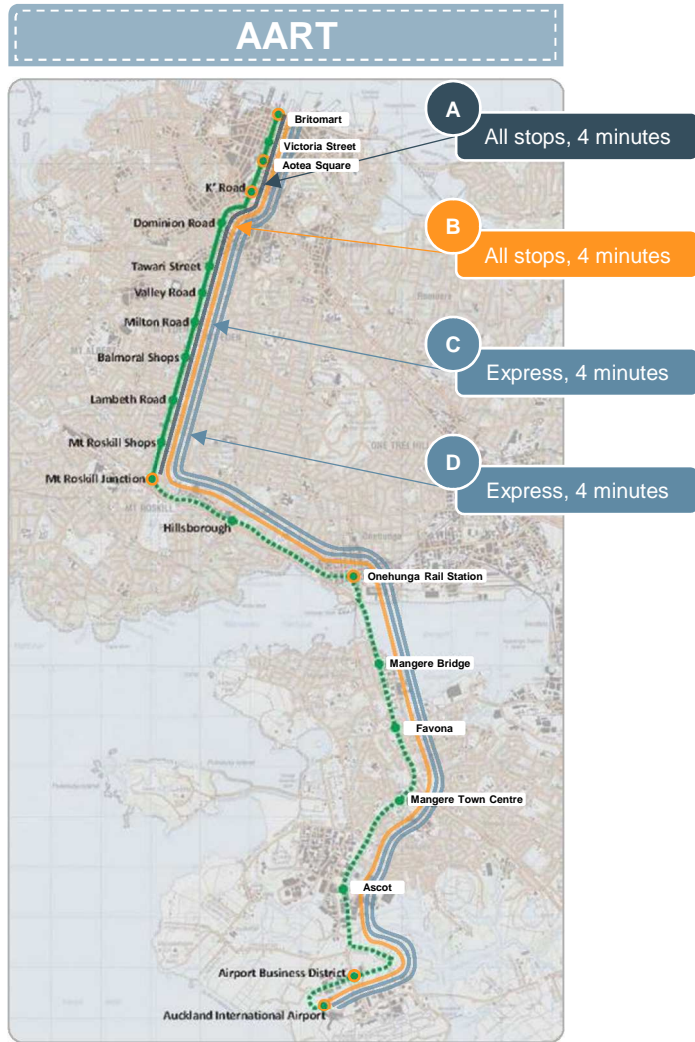

**AART peak travel time (inbound), by service\* (2026F – 46F)**

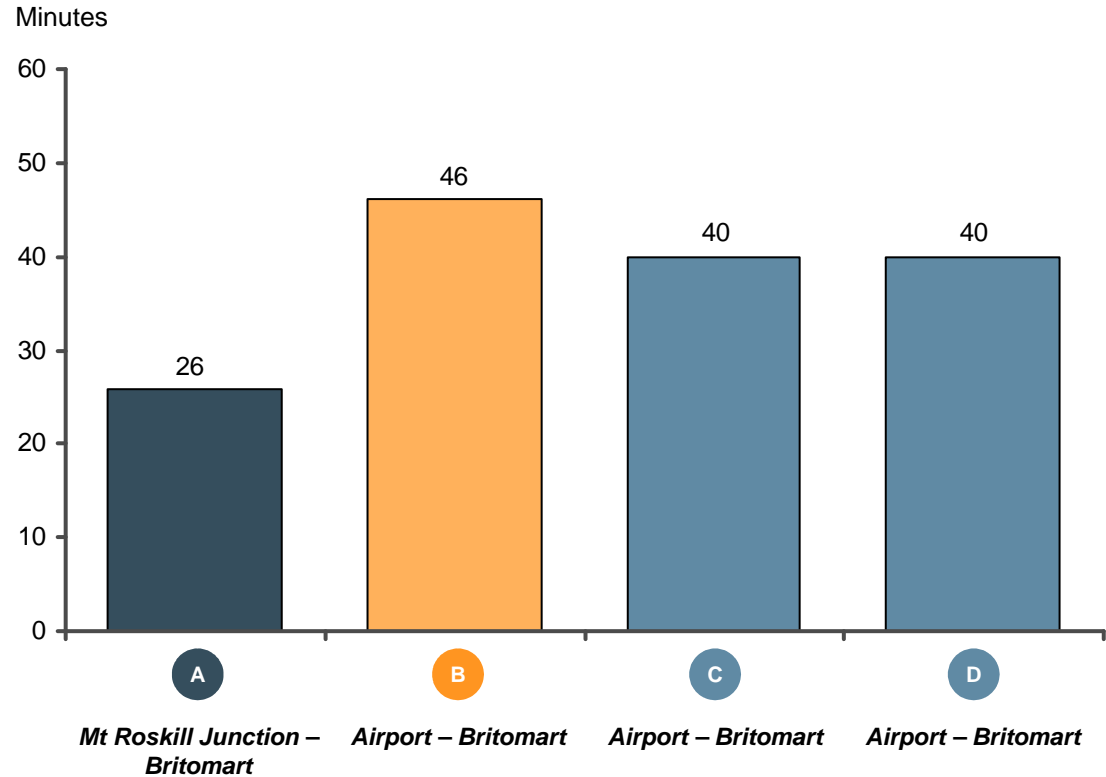

Conservative journey time based on 25km/h urban and 55km/h on SH20 (85<sup>th</sup> percentile speed profile may suggest 28km/h urban and 80km/h on SH20)  
 'Express' services are treated the same as 'all stops' services in the modelling; this would also be worth including in future sensitivity tests

Note: \* Inbound defined as towards the city centre  
 Source: JMAC ART3 / APT3 model output; L.E.K. analysis

# In AART+, the 'express' service that operates along the Dominion Rd corridor is slightly faster than the 'express' service along the Manukau Rd corridor

**AART+ peak travel time (inbound), by service\*  
(2026F – 46F)**

Minutes

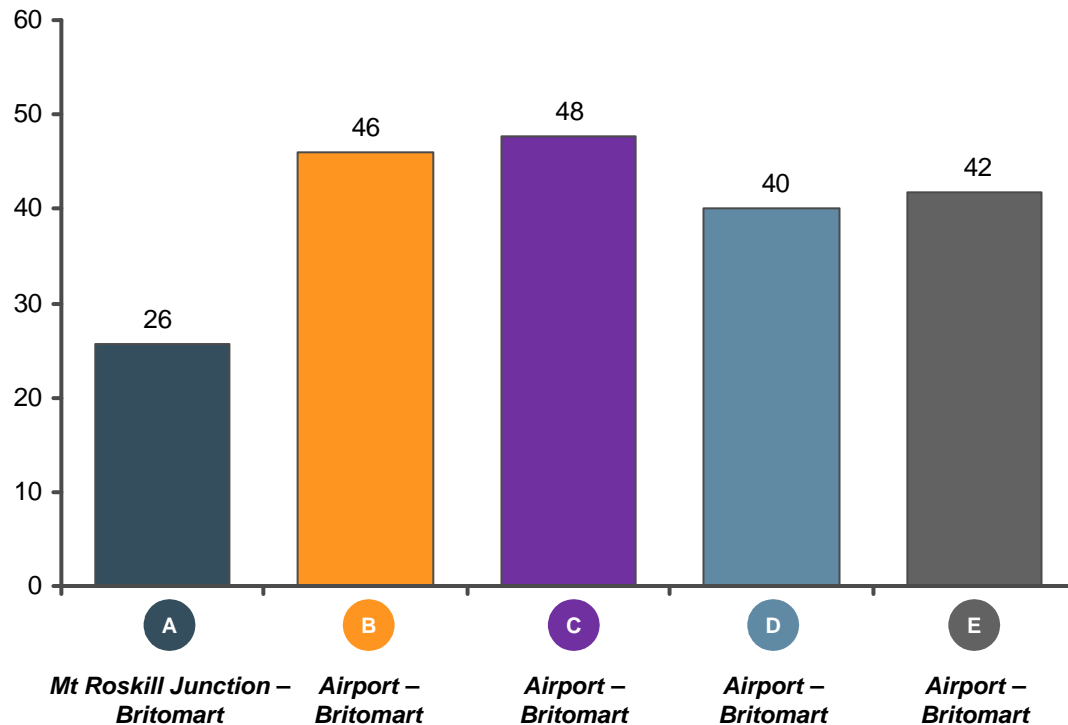

Conservative journey time based on 25km/h urban and 55km/h on SH20 (85<sup>th</sup> percentile speed profile may suggest 28km/h urban and 80km/h on SH20)  
 'Express' services are treated the same as 'all stops' services in the modelling; this would also be worth including in future sensitivity tests

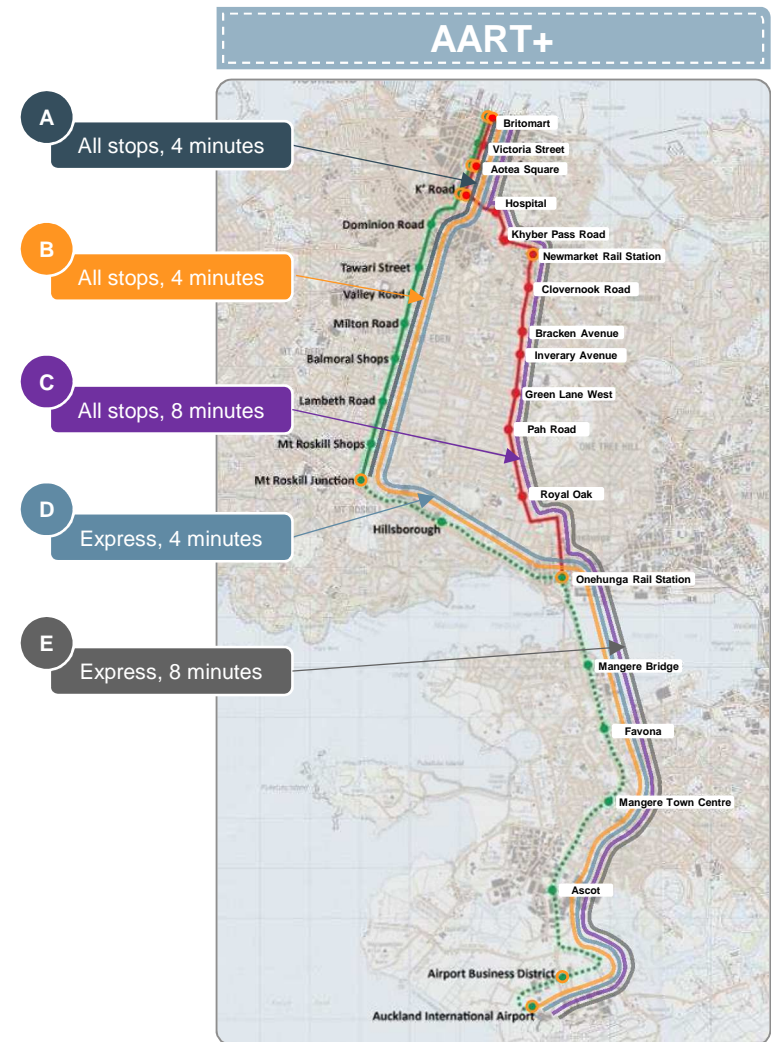

Note: \* Inbound defined as towards the city centre  
 Source: JMAC ART3 / APT3 model output; L.E.K. analysis

# The forecast demand at the pinch points on Queen St and Dominion Rd can be met by the AART system capacity through 2046

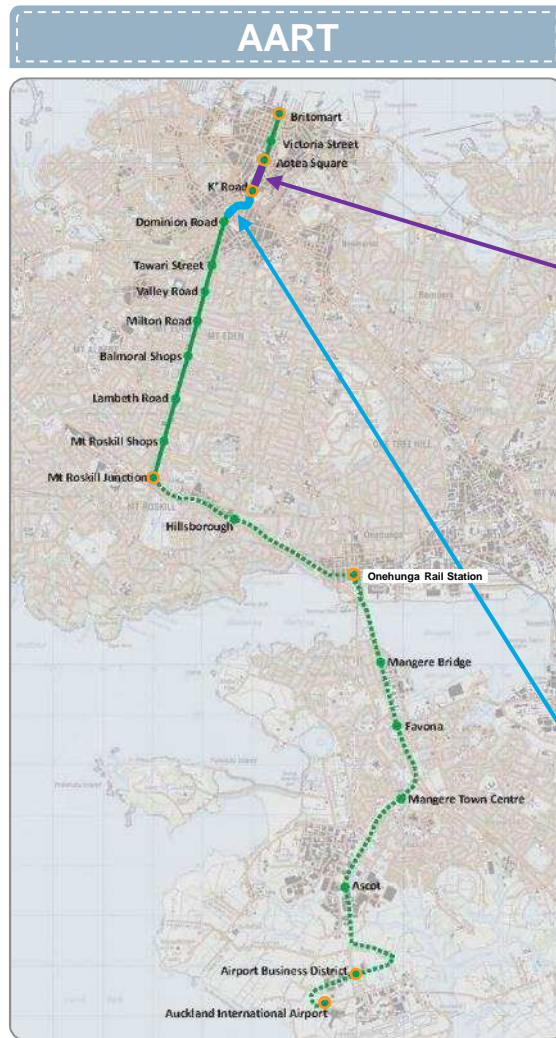

**AART forecast demand and capacity (one-hour AM peak),  
Queen St: K'Road to Aotea Square (Inbound)\*  
(2026F – 46F)**

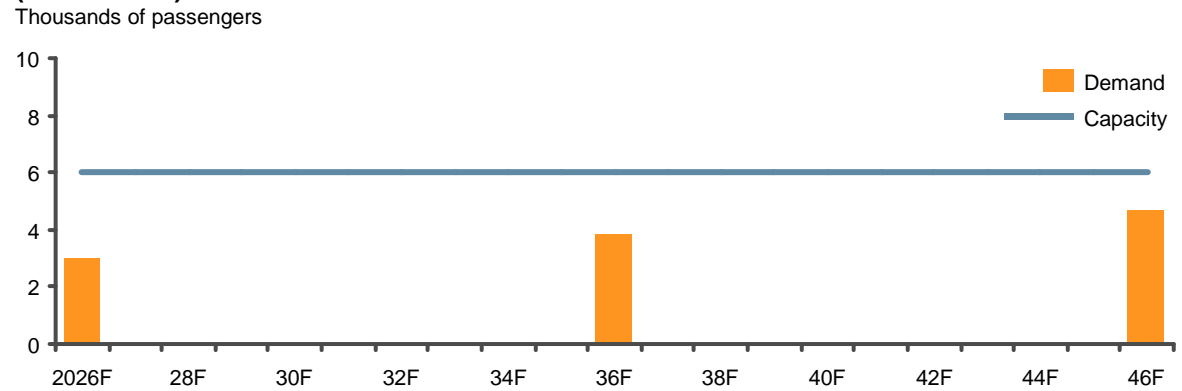

**AART forecast demand and capacity (one-hour AM peak),  
Dominion Rd: Dominion Rd to K'Road (Inbound)\*  
(2026F – 46F)**

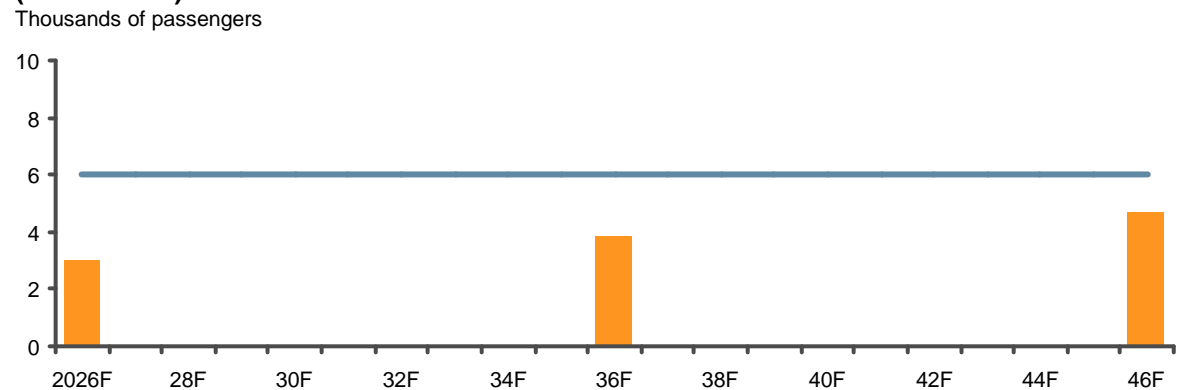

Note: \* Capacity is based on 100 passengers for both articulated and double-decker ABS vehicles (incl. seated and standing passengers). One hour peak demand was calculated by multiplying the two hour peak demand by a factor of 0.6. Based on the 'No Crowd' demand output. Inbound defined as Airport to city centre  
Source: JMAC ART3 / APT3 model output; L.E.K. analysis

# The forecast demand at the pinch points along SH20 can be met by the AART system capacity through 2046



**AART forecast demand and capacity (one-hour AM peak),  
SH20: Hillsborough to Mt Roskill Junction (Inbound)\*  
(2026F – 46F)**

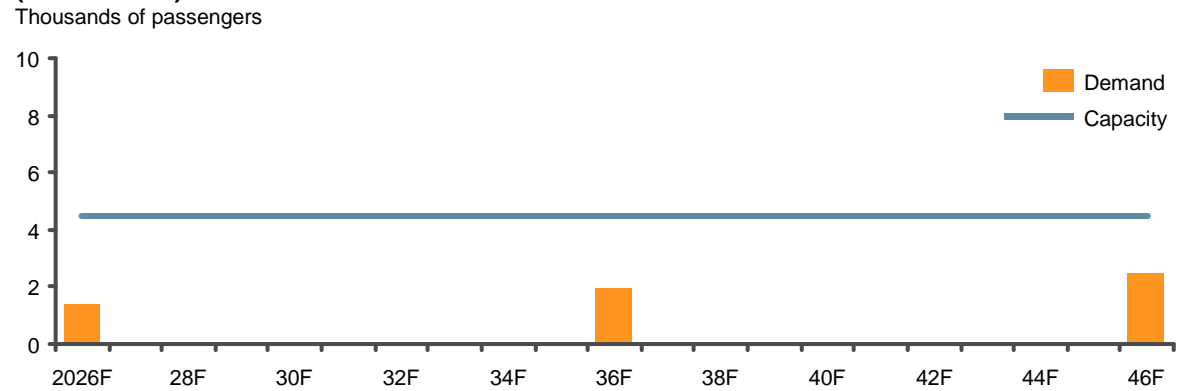

**AART forecast demand and capacity (one-hour AM peak),  
SH20: Favona to Mangere Town Centre (Outbound)\*  
(2026F – 46F)**

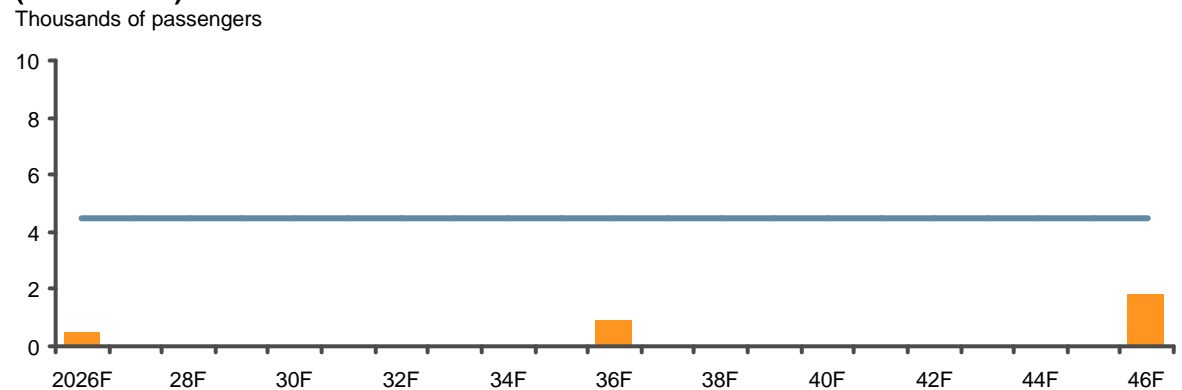

Note: \* Capacity is based on 100 passengers for both articulated and double-decker ABS vehicles (incl. seated and standing passengers). One hour peak demand was calculated by multiplying the two hour peak demand by a factor of 0.6. Based on the 'No Crowd' demand output. Inbound defined as Airport to city centre  
Source: JMAC ART3 / APT3 model output; L.E.K. analysis



# The forecast demand at pinch points on Queen St and Dominion Rd exceeds the AART+ system capacity when the articulated bus capacity is 100 passengers...

**AART+ forecast demand and capacity (one-hour AM peak),  
Queen St: K'Road to Aotea Square (Inbound)\*  
(2026F – 46F)**

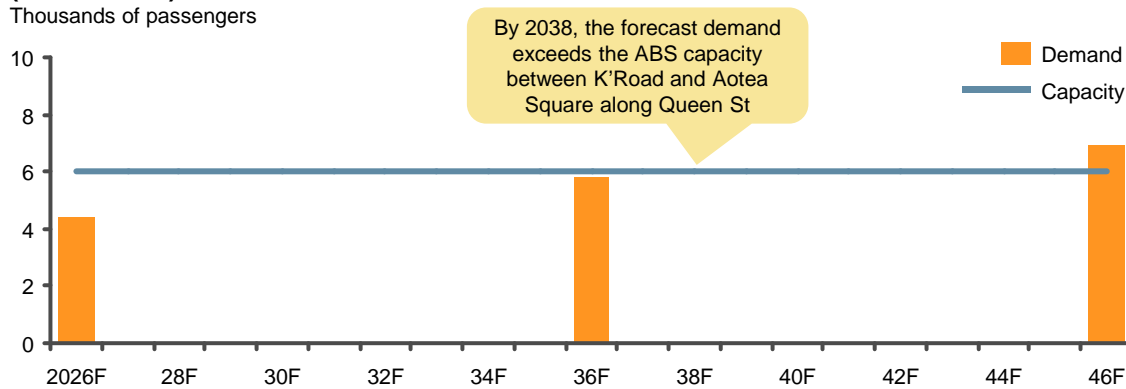

**AART+ forecast demand and capacity (one-hour AM peak),  
Dominion Rd: Dominion Rd to K'Road (Inbound)\*  
(2026F – 46F)**

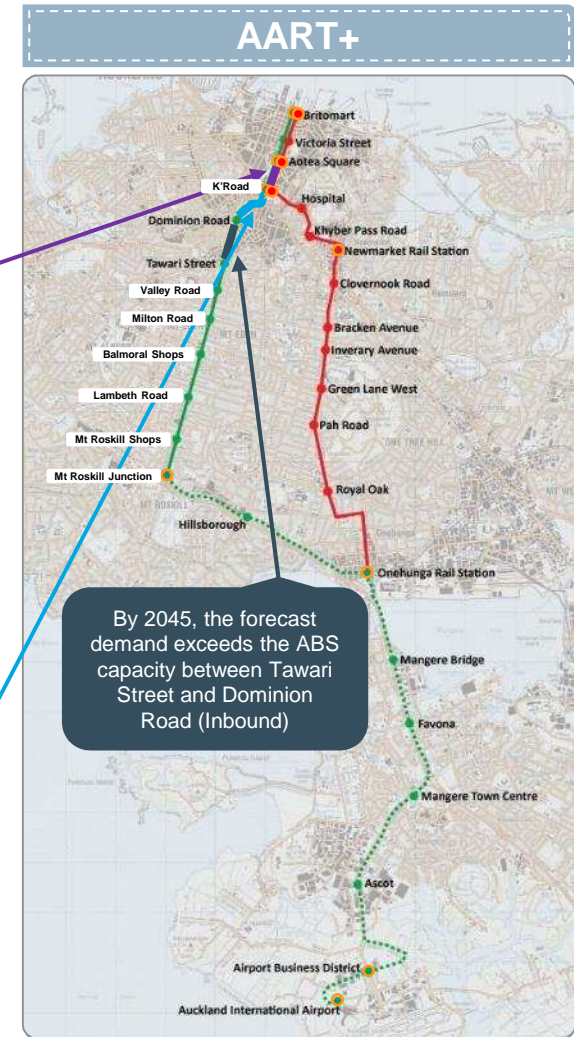
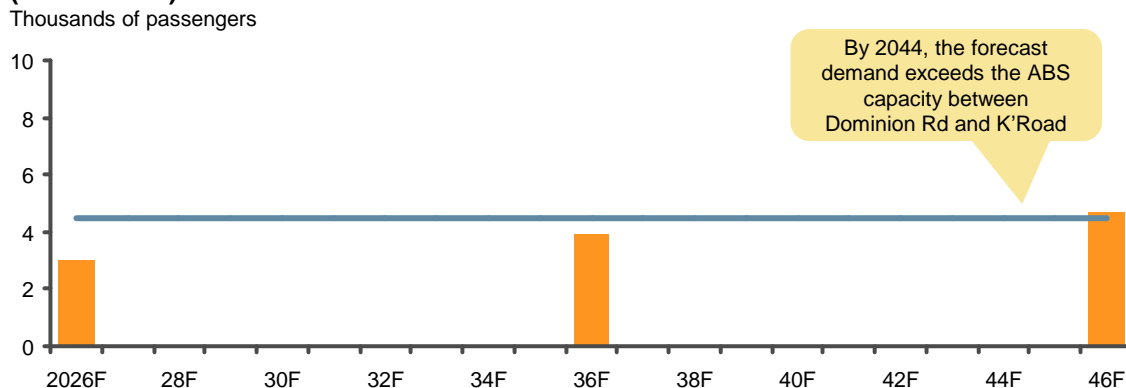

Note: \* Capacity is based on 100 passengers for both articulated and double-decker ABS vehicles (incl. seated and standing passengers). One hour peak demand was calculated by multiplying the two hour peak demand by a factor of 0.6. Based on the 'No Crowd' demand output. Inbound defined as Airport to city centre  
Source: JMAC ART3 / APT3 model output; L.E.K. analysis

# ... increasing the articulated bus capacity to 140 passengers means that the capacity can meet the forecast demand at these points through 2046

**AART+ forecast demand and capacity (one-hour AM peak),  
Queen St: K'Road to Aotea Square (Inbound)\***

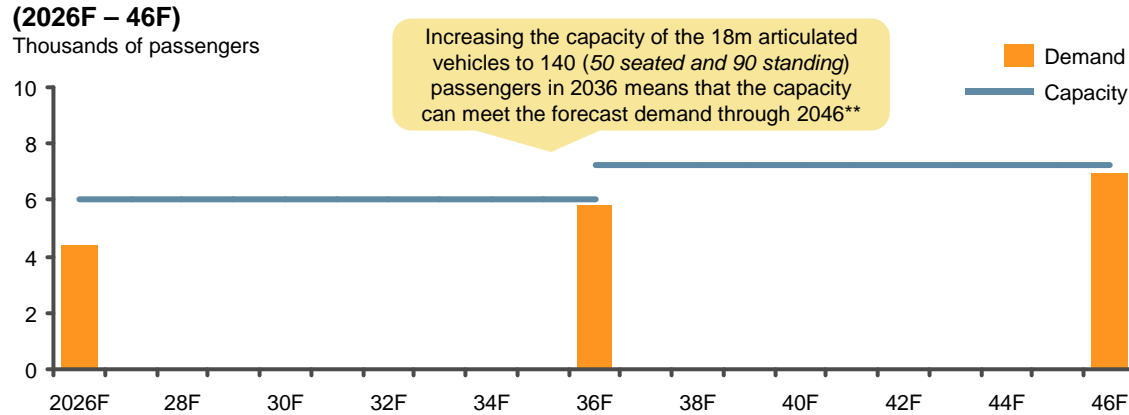

**AART+ forecast demand and capacity (one-hour AM peak),  
Dominion Rd: Dominion Rd to K'Road (Inbound)\***

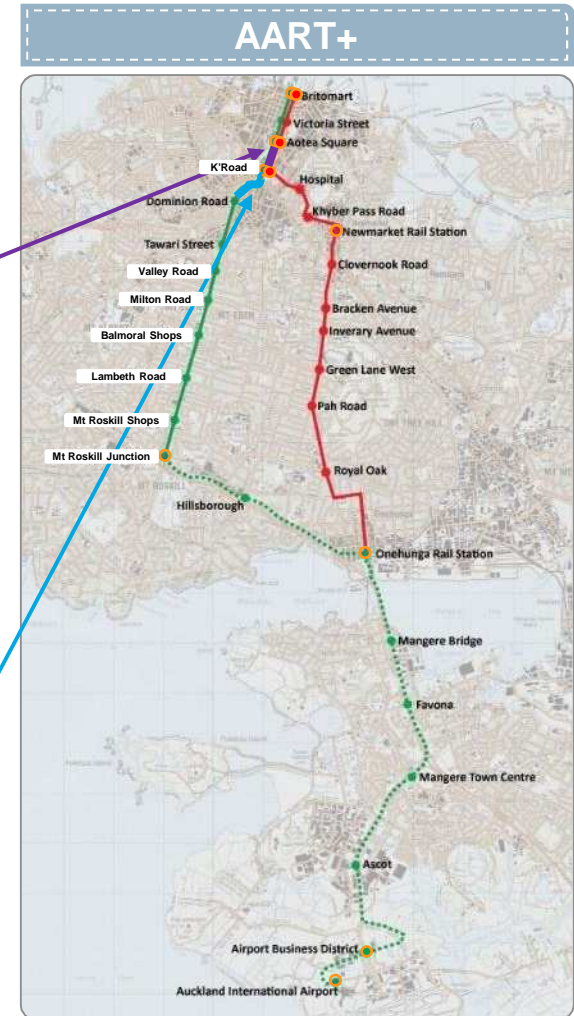
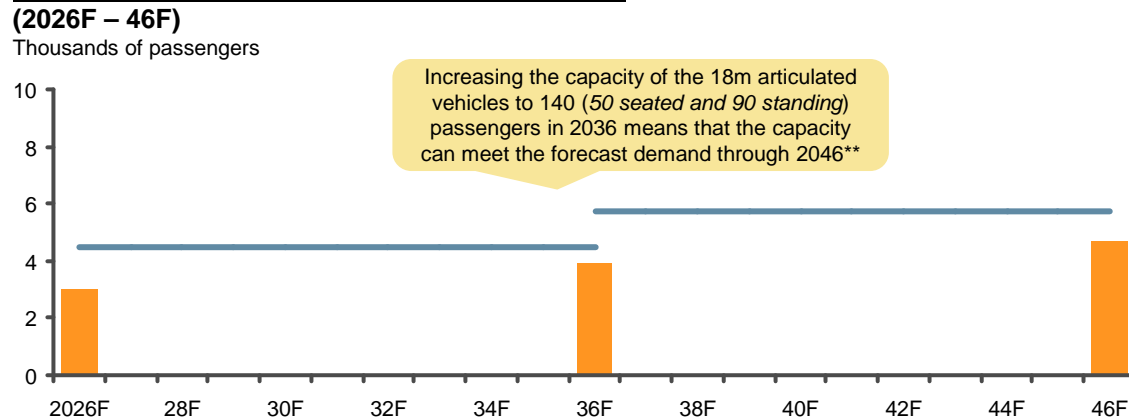

Note: \* Capacity is based on 100 passengers from 2026 for both articulated and double-decker ABS vehicles (incl. seated and standing passengers) and increased to 140 passengers in 2036 for the articulated ABS vehicles only. One hour peak demand was calculated by multiplying the two hour peak demand by a factor of 0.6. Based on the 'No Crowd' demand output. Inbound defined as Airport to city centre; \*\* While an alternative to increasing vehicle capacity is increasing the service frequency, any service planning proposal for the ABS would have consequences to other services and to the overall public transport provision for Auckland. As such, a specific number of vehicles have been maintained as part of the fleet  
Source: JMAC ART3 / APT3 model output; L.E.K. analysis

# The forecast demand at the pinch points on SH20 can be met by the AART+ system capacity through 2046 (1 of 2)

**AART+ forecast demand and capacity (one-hour AM peak),  
SH20: Hillsborough to Mt Roskill Junction (Inbound)\*  
(2026F – 46F)**

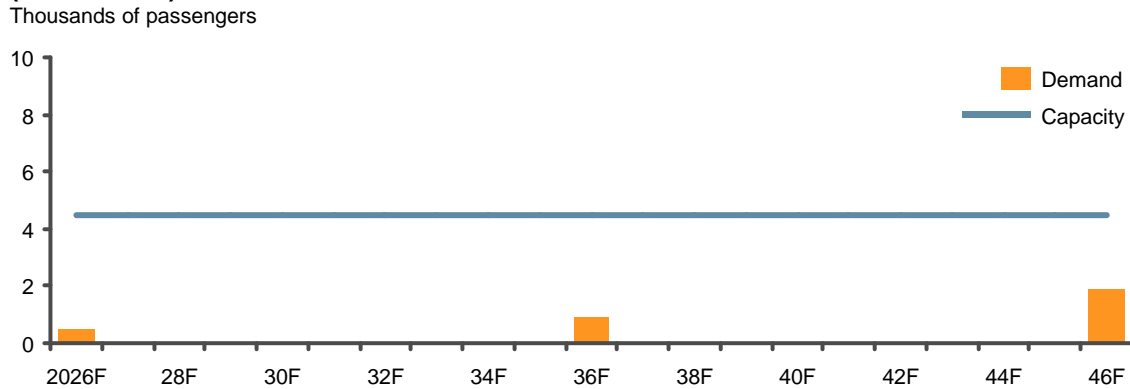

**AART+ forecast demand and capacity (one-hour AM peak),  
SH20: Favona to Mangere Town Centre (Outbound)\*  
(2026F – 46F)**

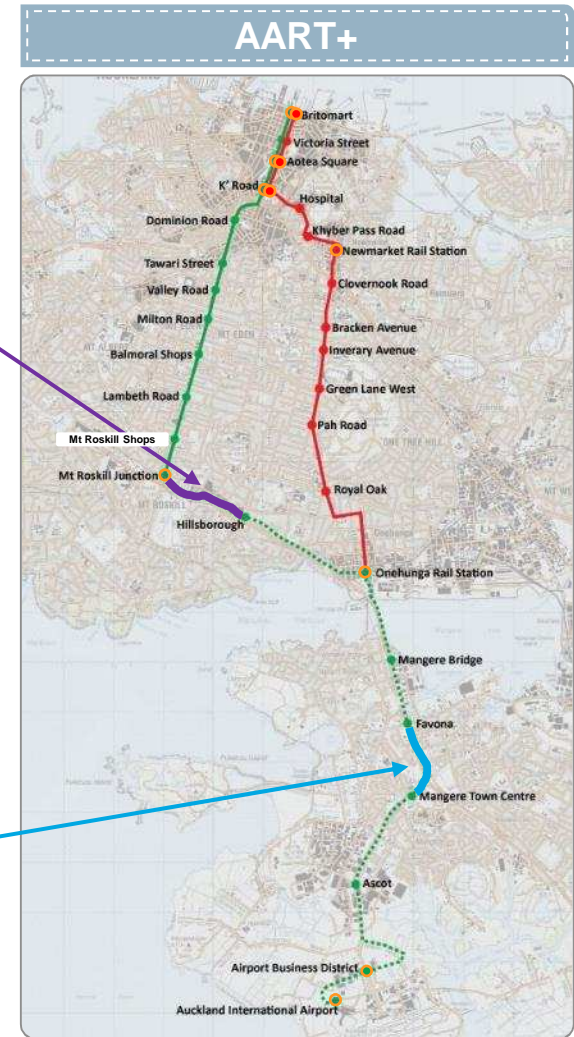
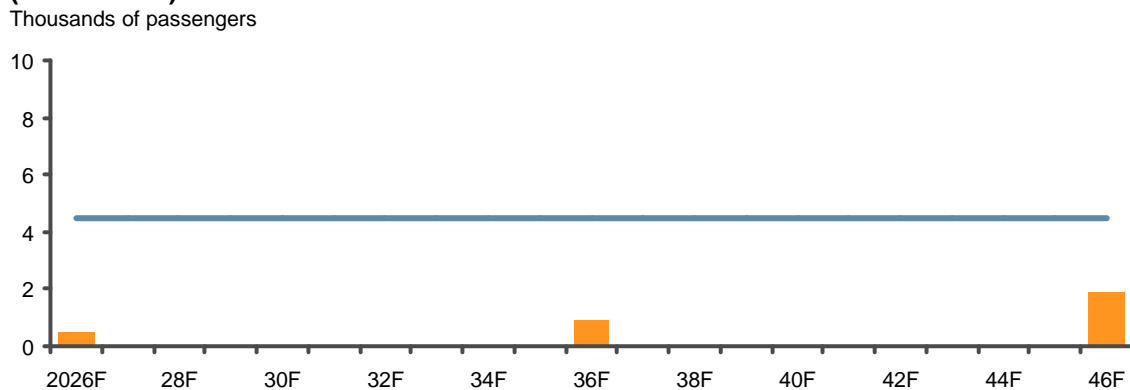

Note: \* Capacity is based on 100 passengers for both articulated and double-decker ABS vehicles (incl. seated and standing passengers). One hour peak demand was calculated by multiplying the two hour peak demand by a factor of 0.6. Based on the 'No Crowd' demand output. Inbound defined as Airport to city centre

Source: JMAC ART3 / APT3 model output; L.E.K. analysis

# The forecast demand at the pinch points on SH20 can be met by the AART+ system capacity through 2046 (2 of 2)

**AART+ forecast demand and capacity (one-hour AM peak),  
SH20: Mangere Bridge to Onehunga Rail Station (Inbound)\*  
(2026F – 46F)**

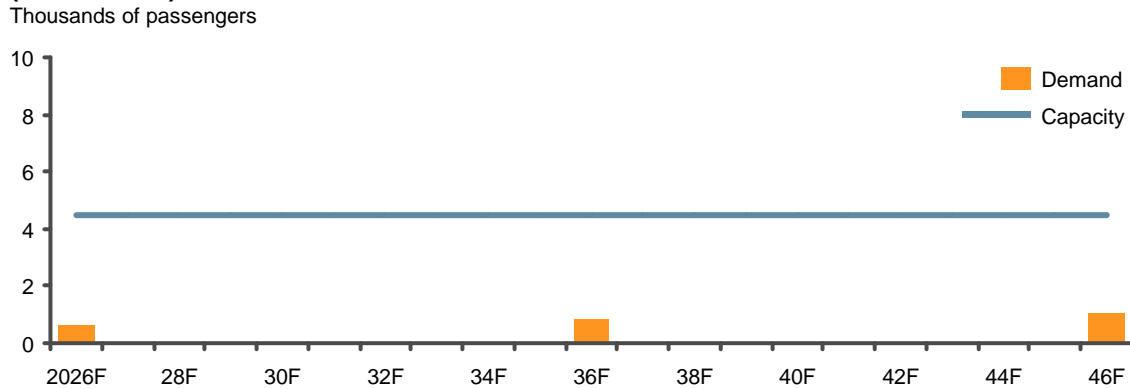

**AART+ forecast demand and capacity (one-hour AM peak),  
SH20: Onehunga Rail Station to Mangere Bridge (Outbound)\*  
(2026F – 46F)**

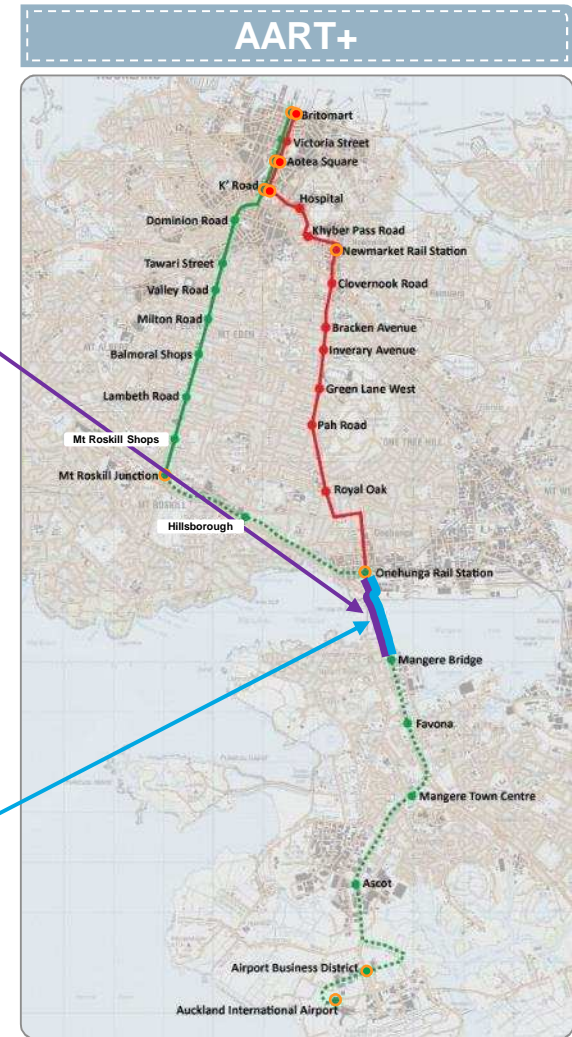
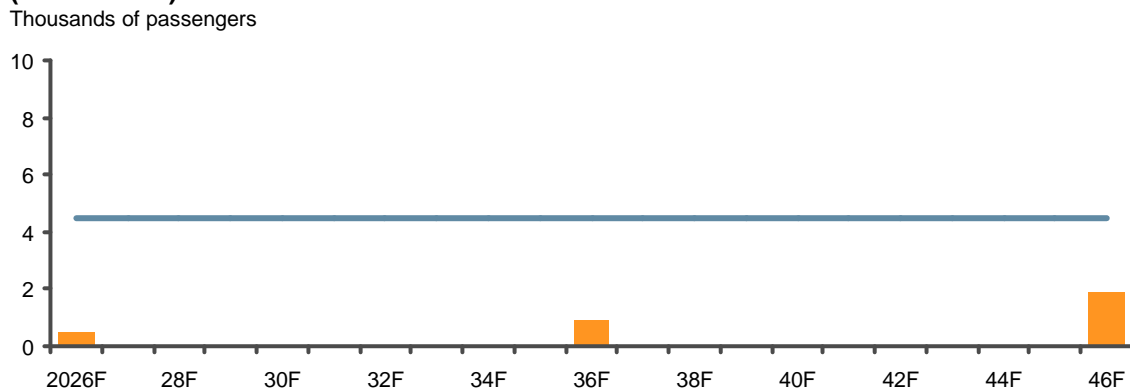

Note: \* Capacity is based on 100 passengers for both articulated and double-decker ABS vehicles (incl. seated and standing passengers). One hour peak demand was calculated by multiplying the two hour peak demand by a factor of 0.6. Based on the 'No Crowd' demand output. Inbound defined as Airport to city centre

Source: JMAC ART3 / APT3 model output; L.E.K. analysis

# Most sections of the Manukau Rd corridor in AART+ are over-capacity well before 2046. Double-decker platoons on this section will alleviate the issue

**AART+ forecast demand and capacity (one-hour AM peak),  
Manukau Rd: Khyber Pass Rd to Hospital (Inbound)\*  
(2026F – 46F)**

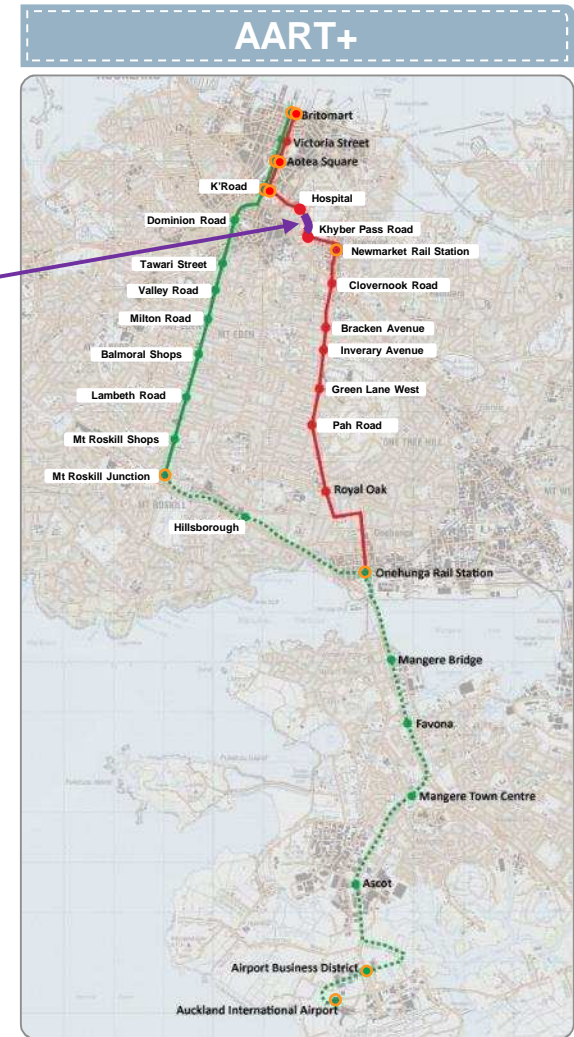
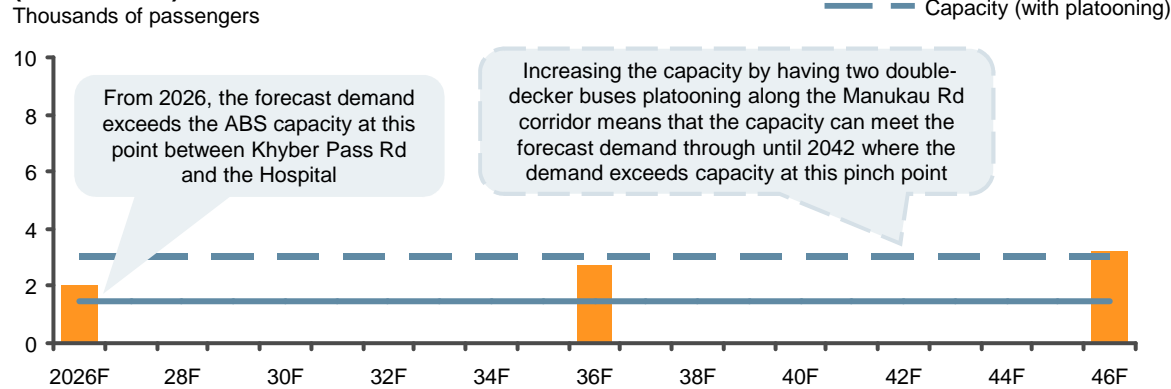

In order to ensure sufficient capacity is provided for the demand along Manukau Rd route in AART+, **vehicle 'platooning' should be introduced for Manukau Rd**. Service frequencies for Dominion Rd should be maintained

- A** an 18m articulated 'all stops' service every four minutes (15 services per hour) from Mt Roskill Junction to Mt Roskill Junction via Britomart along Dominion Rd
- B** an 18m articulated 'all stops' service every four minutes from the Airport to Airport via Britomart along Dominion Rd
- C** a **2 x double decker 'all stops' service** every eight minutes (**15 vehicles per hour**) from the Airport to Airport via Britomart along Manukau Rd
- D** a double decker 'express' service every four minutes from the Airport to Airport via Britomart along Dominion Rd, only stopping at the express ABS stations
- E** a **2 x double decker 'express' service** every eight minutes (**15 vehicles per hour**) from the Airport to Airport via Britomart along Manukau Rd, only stopping at the express ABS stations

Note: \* Capacity is based on 100 passengers for double-decker ABS vehicles (incl. seated and standing passengers). One hour peak demand was calculated by multiplying the two hour peak demand by a factor of 0.6. Based on the 'No Crowd' demand output. Inbound defined as Airport to city centre

Source: JMAC ART3 / APT3 model output; L.E.K. analysis

## Agenda

---

	<i><b>Page ref.</b></i>
● Executive summary	4
● Evaluation framework for the ABS study	15
● Review of current bus solution	26
● Summary of priority initiatives	48
● Outline of ABS options assessed	72
● <b>Assessment of ABS options</b>	<b>197</b>
● Next steps	210

## The ABS study involved an assessment of advanced bus initiatives, development of two potential options and selection of the preferred option

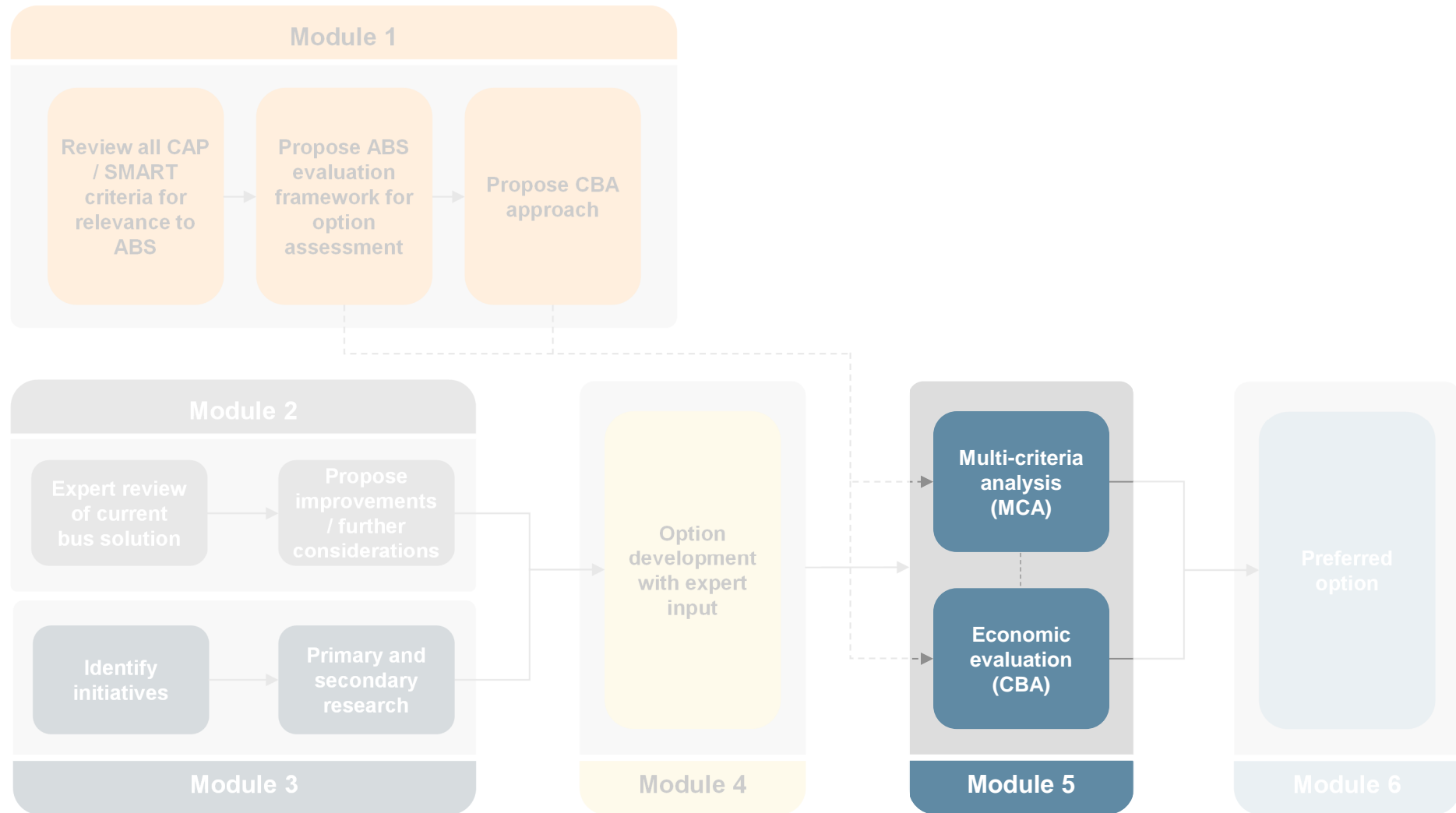

# Walkthrough of the ABS option selection process

---

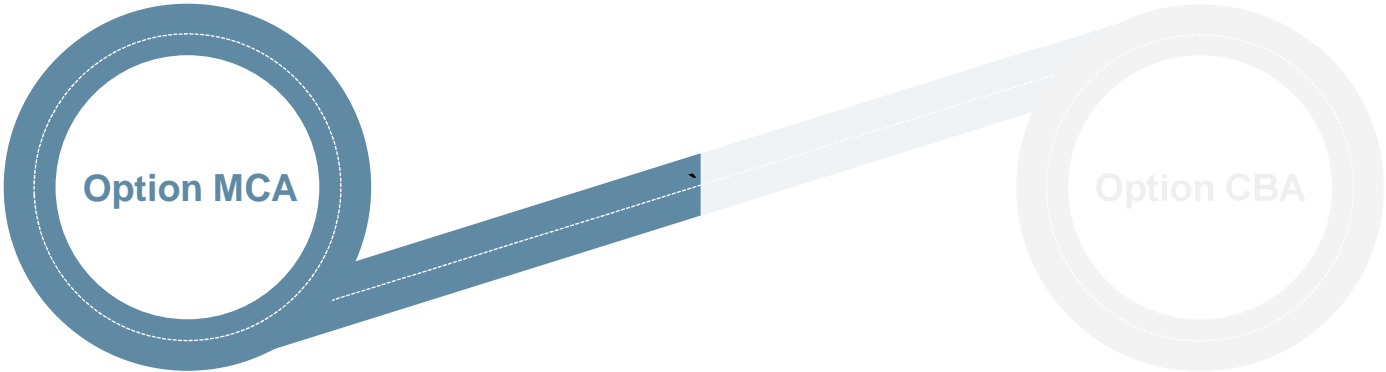



# The multi-criteria analysis (MCA) did not identify a clear preference for either AART or AART+

## Multi-criteria analysis of AART+ relative to AART, unweighted basis (summary)

Theme	Sub-theme (if applicable)	AART+ relative to AART	Commentary
1 Economic growth		Minor positive impact	AART+ serves a larger catchment than AART along two corridors (Dominion Rd and Manukau Rd) and provides additional capacity
2 Network efficiency, reliability and resilience	A To / from Airport and city centre	Minor positive impact	Both options provide similar benefits for travel between the Airport and city centre, with AART+ providing additional reliability benefits and increased patronage
	B In the Mangere-Otahuhu area	Minor positive impact	Both options provide a similar function in the Mangere-Otahuhu area, with AART+ providing additional connections to multiple corridors
	C In the city centre	Minor positive impact	AART+ operates along multiple corridors and so provides some additional benefits to AART in the city centre
	D New technology	No significant impact	There is no significant difference between the options in terms of new technology
3 Liveability and safety	A To / from Airport and city centre	No significant impact	There is no significant difference between the two options except that there is a higher potential for enhancements across multiple corridors
	B In the city centre	Minor negative impact	There is a minor difference between the two options in terms of liveability and safety in the city centre as AART+ has more vehicles operating along Queen St
4 Environmental sustainability		Minor positive impact	AART+ provides slightly higher noise and emissions benefits than AART
5 Implementability		Minor negative impact	AART+ is expected to be more difficult to implement than AART
6 Investment affordability		Minor negative impact	AART+ has a higher cost in net financial terms compared to AART

	AART+ relative to AART
Overall MCA assessment	No significant impact

*AART+ provides some additional benefits relative to AART because AART+ operates over two corridors, serving a larger catchment and providing additional capacity. However, AART+ will be more difficult and costly to implement and operate than AART*

*The MCA did not clearly distinguish between the two ABS options*

**All 75 evaluation criteria were assessed and details have been included in the Appendix**

Key: Major negative impact (orange), Minor negative impact (yellow), No significant impact (grey), Minor positive impact (light green), Major positive impact (dark green)

Source: L.E.K. analysis; Auckland Transport SMART Business Case; CAP programme business case

# Walkthrough of the ABS option selection process

---

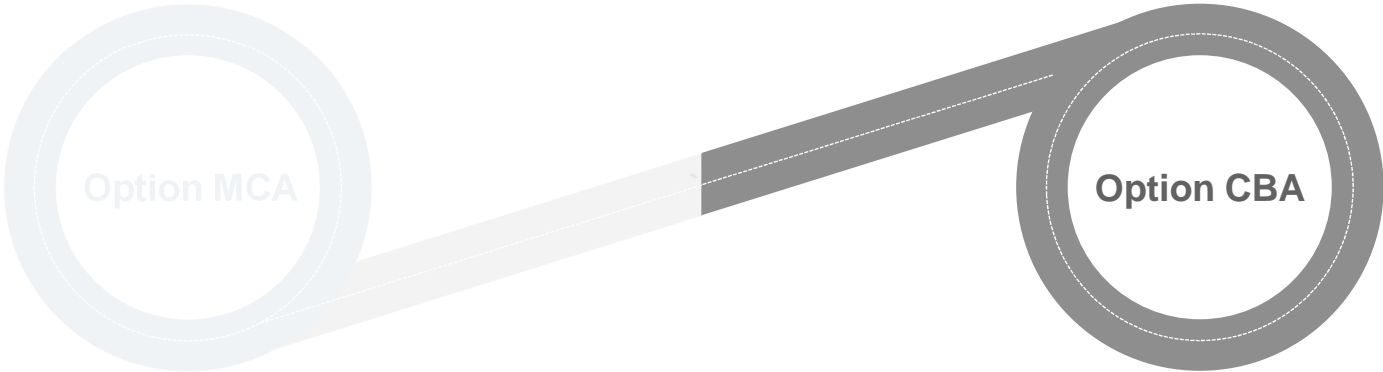

# The Cost Benefit Analysis (CBA) was undertaken based on the approach and principles detailed in the NZTA Economic Evaluation Manual

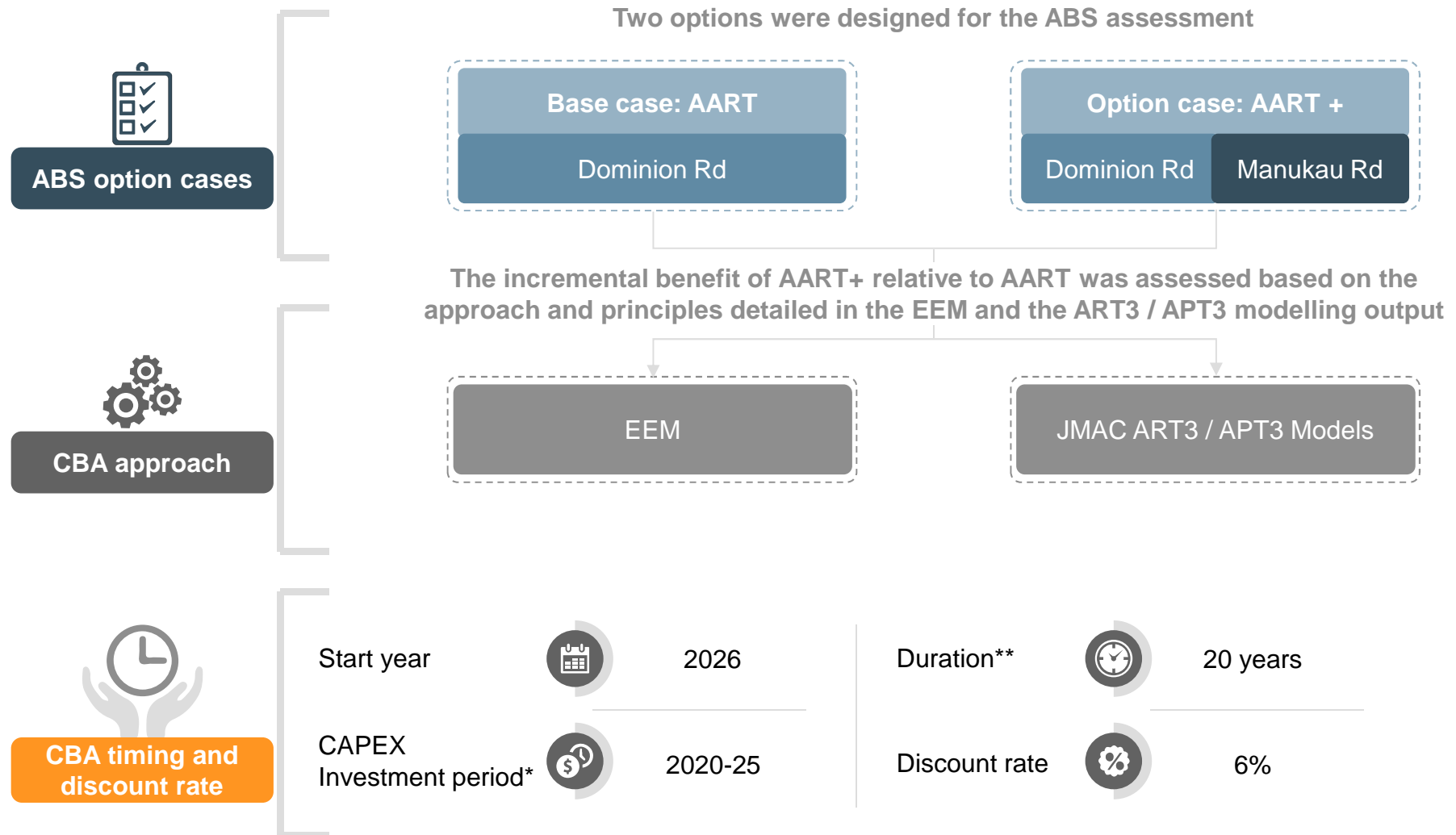

Note: \* Five year construction period with vehicle procurement, testing and commissioning in year 6 (accelerated schedule might be possible); \*\* The CBA base year is 2016 with total CBA evaluation period from 2016 to 2046 and benefit evaluation period from 2026 to 2046

Source: NZTA Economic Evaluation Manual; CAP programme business case; Auckland Transport SMART Business Case

## A key driver of the incremental benefits delivered by AART+ is the uplift in advanced bus patronage tied to the larger rapid transit catchment

### Total advanced bus patronage\*, ART3 / APT3 model output (2026F-46F)

Number of trips

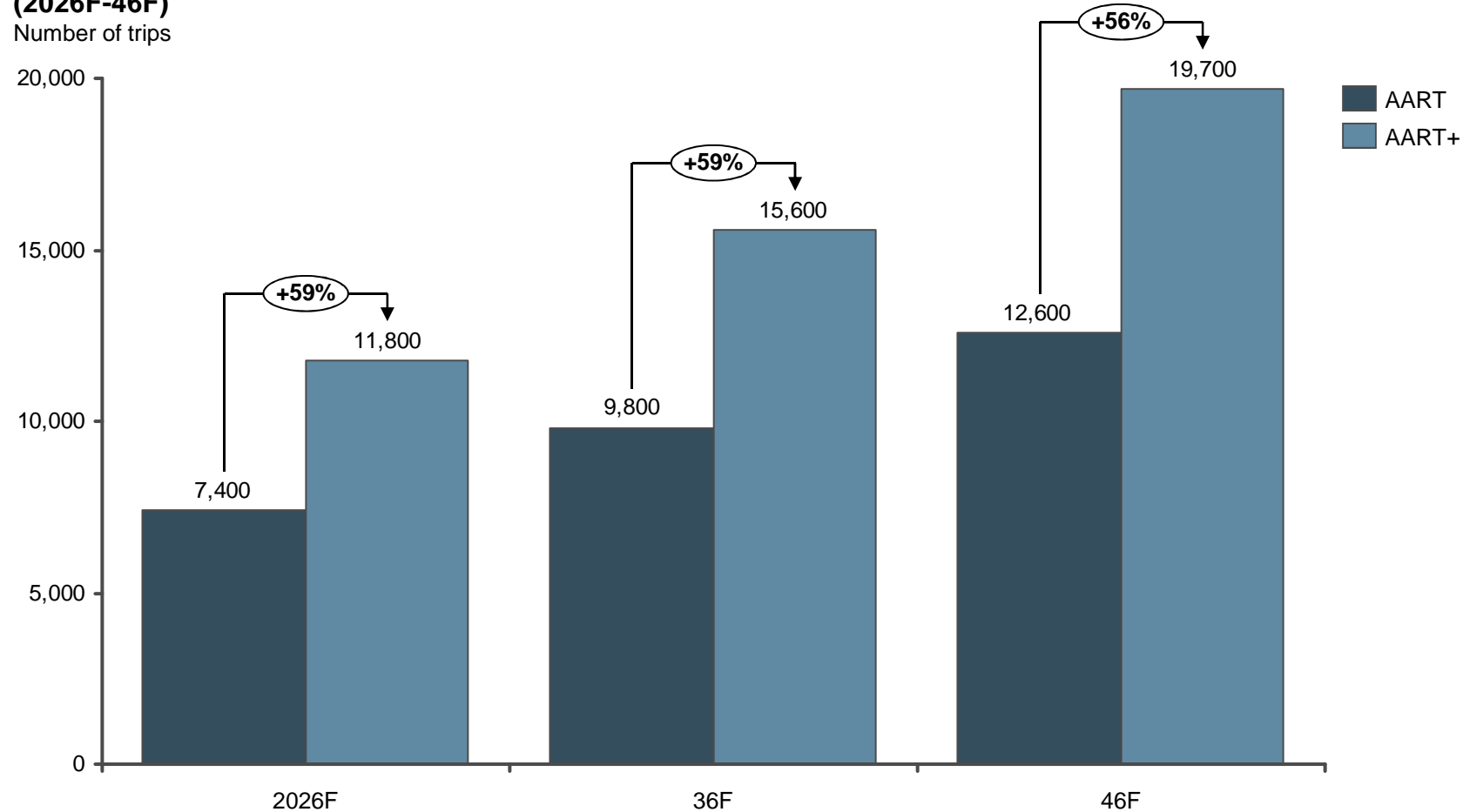

Note: \* Inbound and outbound patronage during 2 hour morning peak period (7am to 9am)

Source: NZTA Economic Evaluation Manual; JMAC ART3 / APT3 model output; L.E.K. analysis

## To identify a preferred option, all key (first order) economic impacts that could be readily quantified were incorporated in the analysis

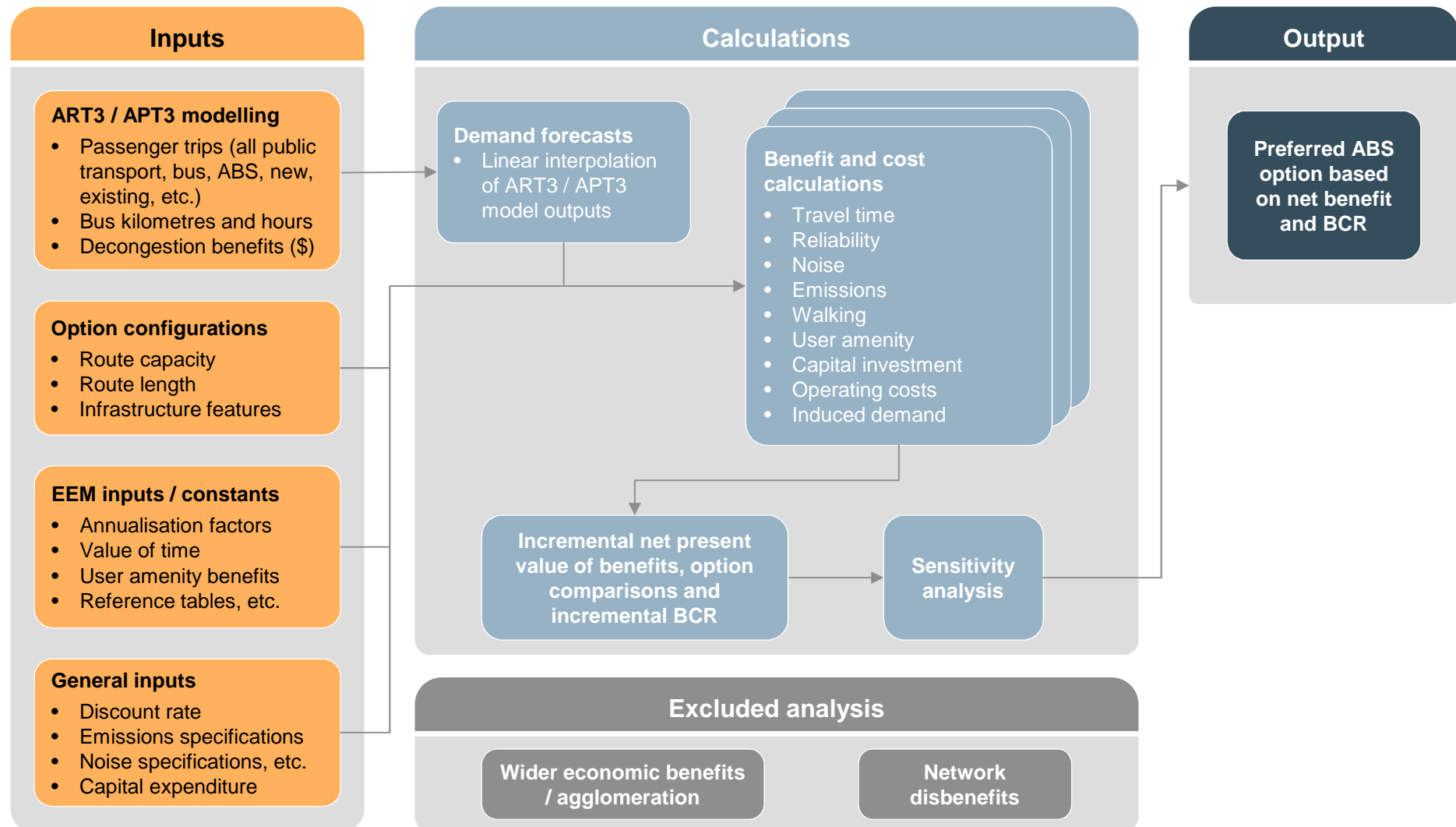

Source: NZTA Economic Evaluation Manual; L.E.K. analysis

## The CBA evaluated eleven criteria in order to determine the incremental benefit delivered by AART+ over AART

### Economic evaluation for ABS: Basis of quantification

Key benefits that were assessed via the CBA		
1	<i>Travel time benefits</i>	Value of travel time savings to existing and new bus users due to improved average speed
2	<i>Traffic decongestion benefit</i>	Value of reduced level of road traffic congestion in the network
3	<i>Reliability benefits</i>	Value of reduced variability in bus journey times to existing and new bus users
4	<i>Noise benefits</i>	The value of public health benefits (sleep and speech disturbance, stress and psychological impacts) due to reduced ambient noise from buses (e.g. progressive introduction of electric buses)
5	<i>Emissions benefits</i>	Value of reduction in emissions based on a defined price for CO <sub>2</sub> , NO <sub>x</sub> and PM <sub>10</sub> from buses (e.g. progressive introduction of electric buses), and from passengers diverted from cars to public transport
6	<i>Walking benefits</i>	The health benefit new users gain from walking to bus stops
7	<i>User amenity benefits</i>	Value of the attributes of bus services and infrastructure to new and existing bus users
8	<i>Residual value benefit</i>	Remaining value of initial infrastructure investment at the end of the analysis period (net present value)
9	<i>Capital investment (CAPEX)</i>	Value of initial investment in order to achieve desired benefits
10	<i>Operating costs (OPEX)</i>	Value of operating costs in order to maintain desired benefits
11	<i>Induced demand (farebox revenue)</i>	Value of additional farebox revenue resulting from induced demand on buses

Source: NZTA Economic Evaluation Manual; L.E.K. analysis

# AART+ is estimated to require additional capital expenditure of c.\$200m and additional operating expenditure of c.\$22m p.a. in 2016 real prices

## Scheduling of required incremental capital expenditure (2020F – 25F)

Millions of NZD (2016 real prices)

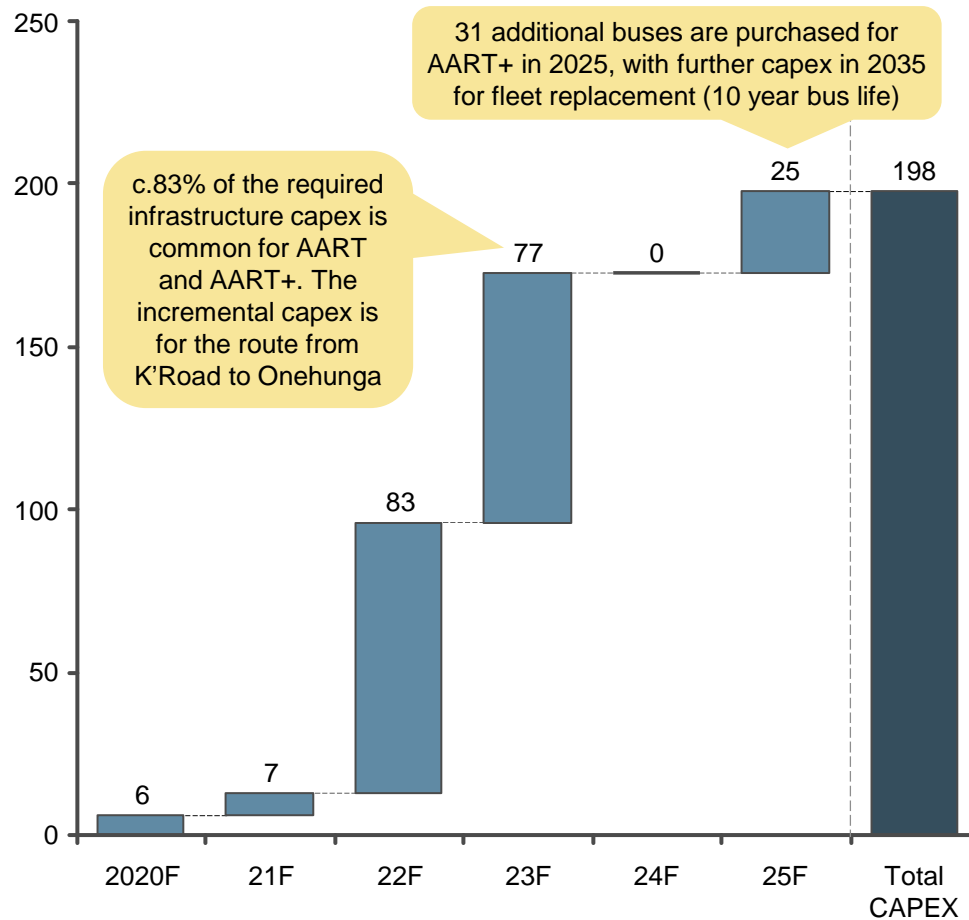

## Incremental operating expenditure per annum (2026F-46F)

Expense item	\$ millions (2016 real prices)
Vehicle operation and maintenance*	19.9
Infrastructure maintenance	2.3
<b>Total</b>	<b>22.2</b>

### Key CAPEX assumptions

- New pavements to the same standard as LRT (deep-lift asphalt)
- Upgrade of streetscapes as per LRT
- Park and ride facilities at outer stations as per LRT
- Cycle facilities as per LRT
- Traffic light alternations and utilities as per LRT
- Excludes: K'Road underpass, CMJ bridge, North Rd bridges, Oakley Creek Culvert (not required for BRT)

Note: \* Vehicle operating expense decrease from 2036 with the transition to autonomous and electric vehicles  
 Source: NZTA Economic Evaluation Manual; JMAC ART3 / APT3 model output; WT Partners; L.E.K. analysis

# Compared with AART, AART+ is estimated to generate an incremental benefit of \$93m in net present value terms (2016 prices) and an incremental BCR of 1.61

## Incremental benefit of AART+ over AART, by type (NPV) (2016)

Millions of NZD

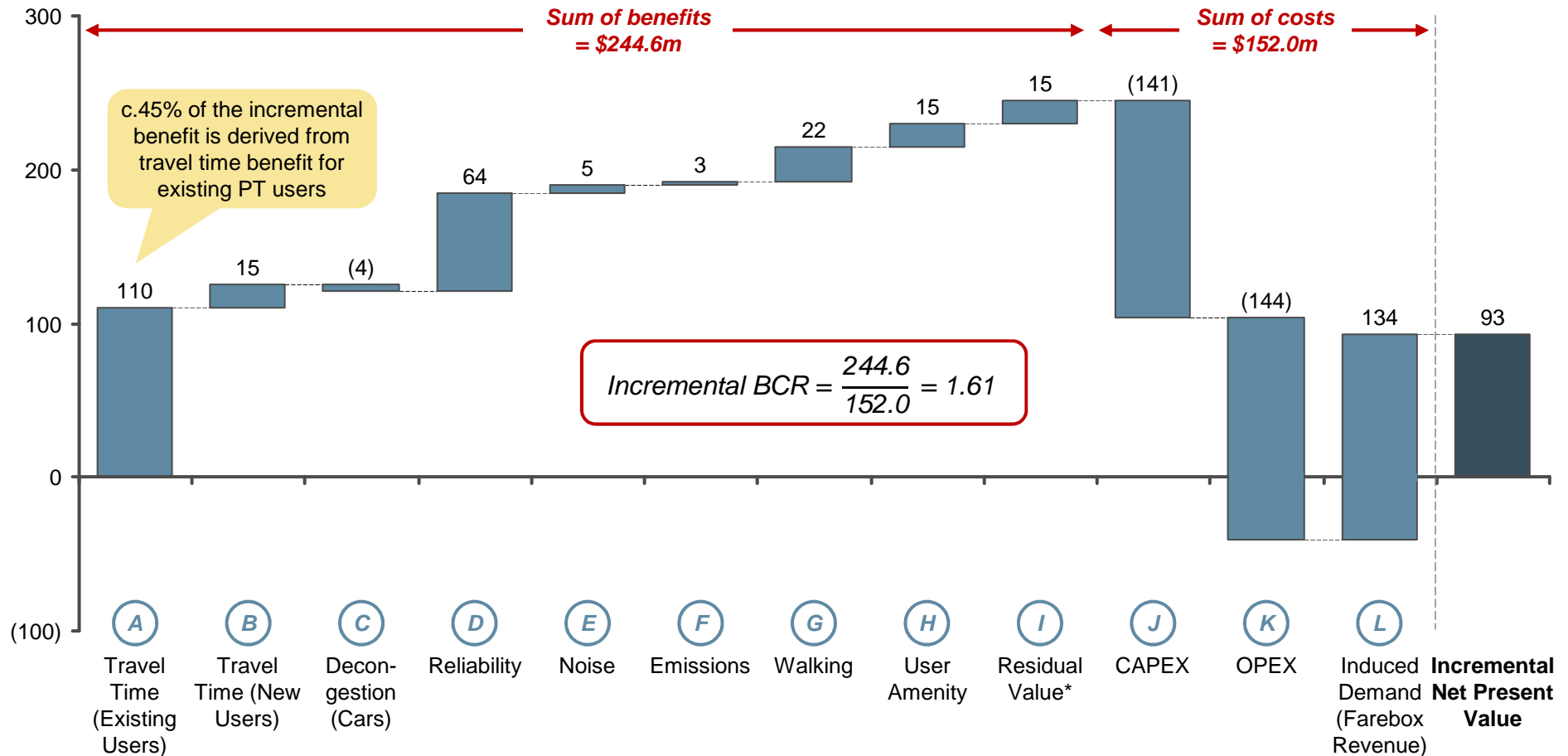

Note: \* The residual value is the net present value (in 2016) of the remaining value of the infrastructure capital expenditure in 2046. The value of the infrastructure in 2046 is calculated using straight-line depreciation over 40 years and is thus 50% of the original capital expenditure

Source: NZTA Economic Evaluation Manual; JMAC ART3 / APT3 model output; L.E.K. analysis



The sensitivity of the CBA was flexed across three metrics, indicating an incremental NPV range of \$37m – \$185m (2016 prices)

Metric	Assessment range	Incremental Net Present Value	Incremental BCR
<i>Discount rate</i>	4%	\$184.9m	2.07
	8%	\$37.4m	1.28
<i>Capital expenditure</i>	-25%	\$124.3m	2.07
	+25%	\$61.1m	1.33
<i>Operating expenditure</i>	-25%	\$128.8m	2.11
	+25%	\$56.6m	1.30

Source: NZTA Economic Evaluation Manual; JMAC ART3 / APT3 model output; L.E.K. analysis

# The MCA does not provide a strong rationale for one option over another while the CBA favours AART+ over AART

Option MCA

Option CBA

Theme	Sub-theme (if applicable)	AART+ relative to AART
Economic growth		Minor positive impact
Network efficiency, reliability and resilience	To / from Airport and city centre	No significant impact
	In the Mangere-Otahuhu area	Minor positive impact
	In the city centre	Minor positive impact
	New technology	No significant impact
Liveability and safety	To / from Airport and city centre	No significant impact
	In the city centre	Minor negative impact
Environmental sustainability		Minor positive impact
Implementability		Major negative impact
Investment affordability		Major negative impact
Overall assessment		No significant impact

*AART+ provides some additional benefits relative to AART because AART+ operates over two corridors, serving a larger catchment and providing additional capacity. However, AART+ will be more difficult and costly to implement and operate than AART. The MCA did not clearly distinguish between the two ABS options*

Incremental benefit of AART+ over AART, by type (NPV) (2016)

Millions of NZD

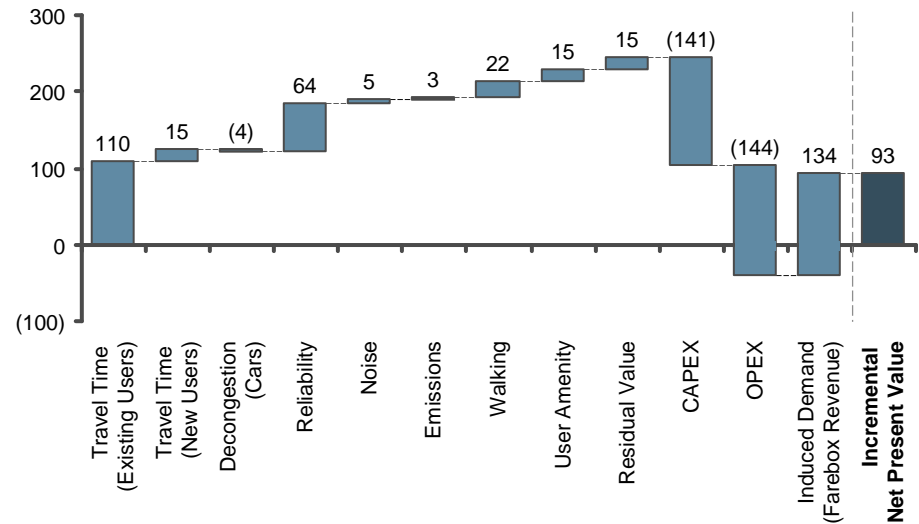

**Incremental Net Present Value: \$92.7m**

**Incremental BCR: 1.61**

*AART+ provides a greater catchment area, which is the primary driver for the travel time and induced demand benefits. This more than offsets the additional capital and operating costs associated with the delivery of AART+*

Key: Major negative impact (Orange), Minor negative impact (Yellow), No significant impact (Grey), Minor positive impact (Light Green), Major positive impact (Dark Green)

Source: NZTA Economic Evaluation Manual; JMAC ART3 / APT3 model output; L.E.K. analysis

## Agenda

---

	<i><b>Page ref.</b></i>
● Executive summary	4
● Evaluation framework for the ABS study	15
● Review of current bus solution	26
● Summary of priority initiatives	48
● Outline of ABS options assessed	72
● Assessment of ABS options	197
● <b>Next steps</b>	<b>210</b>

## There are a number of key topics that warrant further consideration

### *Integrated service planning*

- We believe the mix of high frequency 'express' and 'all stops' services provide adequate capacity to meet long-term demand needs (i.e. to 2046) with an appropriate level of amenity (i.e. seated vs. standees) and an increased opportunity for overall network resilience via possible through routing, southern origins (i.e. Manukau City) and meeting the problem definition for airport access for travellers and terminal workers
- Integration and optimisation required for the ABS network and the New Network solution, such that PT patronage can be maximised whilst meeting appropriate levels of customer amenity

### *Overtaking*

- For both AART and AART+ the service plan proposals used for the base assessment have sought to utilise all stops and express services such that passing will be required; as such this presentation includes some additional visualisation of these options; however, the use of a microsimulation or detailed animation package may be required to aid operational understanding in the future

### *CBD layover optimisation*

- Identified strategies to minimise and optimise CBD layovers through a range of initiatives (e.g. airport layovers, CBD through running, short term facilities in Commerce Street, virtual layovers, etc.) require further evaluation
- Overnight storage of a number of buses are required for the 5am start time from Queen St and this would need to be associated with the ability to re-fuel and clean vehicles as necessary

### *Traffic management*

- Detailed analysis will be required to assess and develop appropriate mitigation strategies for both general traffic, for example at major east-west intersections, and bus traffic more specifically (e.g. intersection micro-simulation analysis), accounting for advanced ITS technologies such as fleet management, signal priority, precision docking, etc.
- Traffic signal priority for ABS buses and the demand for pedestrians to access the stations, as well as integrate with the other key PT interchanges such as Wellesley St, Britomart, Aotea, Onehunga and Newmarket

### *Vehicle type / propulsion*

- Timing for technology shifts in propulsion requires detailed analysis into the pro's and con's of the opening year choices versus the 2036 or 2046 requirements; e.g. full electric vehicles are heavier than hybrid electric due to larger batteries and this may mean axle loadings are exceeded with less passengers
- Service planning may include removal of full electric in off peak times and operate in peak hours only
- Larger scale buses are being developed to meet urban demand for BRT and exceed now 300 passengers, such proposals may provide significant rapid transit capacity without high frequencies

## Further work will need to be done to develop the service plans for AART / AART+, and it will need to be an iterative process

Integrated service  
planning

- A “**simple service plan**” was derived for the purpose of demand modelling; however, the **strategic principles of service planning** have also been defined and some amendments to aid discussions and provide for future study next steps
- The long term service planning of the ABS and the CBD New Network services include the following:
  - service levels, i.e. service frequency – assumed to be required as **5am to 1am (20 hours)**
  - vehicle types, size and vehicle capacity as well as propulsion type
  - **core route selection for the ABS for AART / AART+**
  - ‘New Network’ changes required to accommodate these solutions; creation of a ‘**Hub and Spoke**’ service (*AT has advised some changes to date*)
  - service patterns to be a mix of ‘all stops’ and ‘express’ services on **both** the Dominion Rd and Manukau Rd corridors
  - limited layover in the CBD (Commerce St); all terminal and depot requirements for the ABS to be focused at the airport
  - ABS services to be **Mount Roskill Junction to Mount Roskill Junction via Britomart ‘all stops’ service** and the **Airport to Airport via the CBD ‘express’ services** on Manukau Rd and Dominion Rd
  - all ABS services to include an advanced Intelligent Transport System suite of on-board and on-road devices and be managed by the **Fleet Management System (via the Operations Centre)**
  - **100% dedicated right of way for Dominion Rd** and some mixed operations sections for Manukau Rd
  - intersection upgrades to traffic signal control and ABS ‘Traffic Signal Priority’ proposals
  - station design and operational information related to boarding and alighting times including 100% off-board ticketing

### Next steps

*A full integrated service planning process is required to develop a detailed operational outcome for the entire Auckland CBD public transport network*

# Model inputs for the JMAC model runs and feasible alternatives for the operational service plan for AART and AART+

Integrated service planning

<p><b>ABS vehicle capacity</b></p>	<ul style="list-style-type: none"> <li>● <b>MODELLED ASSUMPTION</b> <ul style="list-style-type: none"> <li>- 18m specialised, articulated ABS vehicles (100 persons per vehicle; 60 seated and 40 standing)</li> <li>- double decker ABS vehicles (100 persons per vehicle; 85 seated and 15 standing)</li> </ul> </li> <li>● <b>For the options, the vehicle capacity may reduce the total vehicle numbers as follows:</b> <ul style="list-style-type: none"> <li>- double deckers (130 persons per vehicle; 90 seated and 40 standing) – Singapore</li> <li>- 18m vehicles (140 persons per vehicle; 50 seated and 90 standing) – Singapore</li> <li>- 19.5m vehicles (190 persons per vehicle; 40 seated and 150 standing) – Istanbul</li> <li>- 24-26m vehicles (230 persons per vehicle; 50 seated and 180 standing) – Istanbul</li> </ul> </li> </ul>	
<p><b>Corridor speed</b></p>	<ul style="list-style-type: none"> <li>● <b>MODELLED ASSUMPTION</b> <ul style="list-style-type: none"> <li>- stop to stop travel time based on distance for the CBD section (Britomart to SH20) with an average travel time of 25km/hr</li> <li>- stop to stop travel time based on distance for the SH20 section (SH20 to the Airport) with an average travel time of 55km/hr</li> </ul> </li> <li>● <b>Actual average travel time for the express services</b> would be higher as less deceleration and acceleration required</li> </ul>	
<p><b>Station dwell time</b></p>	<ul style="list-style-type: none"> <li>● <b>MODELLED ASSUMPTION</b> <ul style="list-style-type: none"> <li>- dwell time at stations in the CBD corridor = 30 secs</li> <li>- dwell time at stations in the SH20 corridor = 24 secs</li> </ul> </li> </ul>	<ul style="list-style-type: none"> <li>● <b>Actual dwell time</b> <ul style="list-style-type: none"> <li>- 15 to 20 seconds on a 2 minute headway in all sections</li> </ul> </li> </ul>
<p><b>Service patterns and headways</b></p>	<p style="text-align: center;"><b>AART</b></p> <ul style="list-style-type: none"> <li>● <b>'All stops' ABS services</b> – Dominion Rd from Britomart to Mt Roskill Junction or all the way to the Airport (<b>4 mins</b>)</li> <li>● <b>'Express' services</b> – Dominion Rd to provide faster access to the Airport. The express operations will act as peak hour supplementary services to 'all stops' services (<b>4 mins</b>)</li> </ul>	<p style="text-align: center;"><b>AART+</b></p> <ul style="list-style-type: none"> <li>● <b>'All stops' ABS services</b> – Dominion Rd from Britomart to Mt Roskill Junction or all the way to the Airport (<b>8 mins</b>), plus Manukau Rd airport to Britomart (<b>8 mins</b>)</li> <li>● <b>'Express' services</b> – One route via Dominion Rd to provide faster access to the Airport. The express operations will act as peak hour supplementary services to 'all stops' services (<b>4 mins</b>). One route via Manukau Rd to provide faster access to the Airport. The express operations will act as peak hour supplementary services to 'all stops' services (<b>8 mins</b>)</li> <li>● <b>Manukau Rd would require platooning of double decker services to meet demand</b></li> </ul>

## ABS passing lanes in narrower cross sections can be accommodated in a number of ways

- ABS passing lanes in constrained corridors can be accommodated in a number of ways, which could be evaluated for each ABS station in the detailed project development on a case by case basis
- Four potential ways in which ABS passing lanes could be accommodated include:
  - 1 having 'express' buses leave kerbside bus lanes to pass 'all stops' ABS vehicles stopped at stations, which would be the case for the Manukau Rd services as part of AART+
  - 2 having 'express' buses pass 'all stops' ABS vehicles stopped at stations by going into the opposing lanes of median stations with side platform, parallel or lateral offset stations
  - 3 having 'express' buses pass around 'all stops' ABS vehicles in the mid-block sections where there are no stations and there are parallel ABS lanes that are only separated by road markings, which would be the main options for the Dominion Rd services as there is a consistent central ROW for AART and AART+
  - 4 establishing areas at either end of median stations where 'all stops' ABS vehicles could 'hold' while 'express' buses pass around them, which is easily achieved with the use of the advanced fleet management, which would be required and expected as part of the ABS
- Examples of cities that allow overtaking of express and all stops services include Ahmedabad in India, Guatemala City, Istanbul, Quito Trole corridor in Ecuador, Strasbourg in France and Amsterdam for lines 300 and 310

### Next steps

*A detailed analysis of the passing for express and all-stops services*

# Illustration of accommodating express services (1 of 4)

1 Having 'express' buses leave kerbside bus lanes to pass 'all stops' ABS vehicles stopped at stations, which would be the case for the Manukau Rd services as part of AART+

INDICATIVE

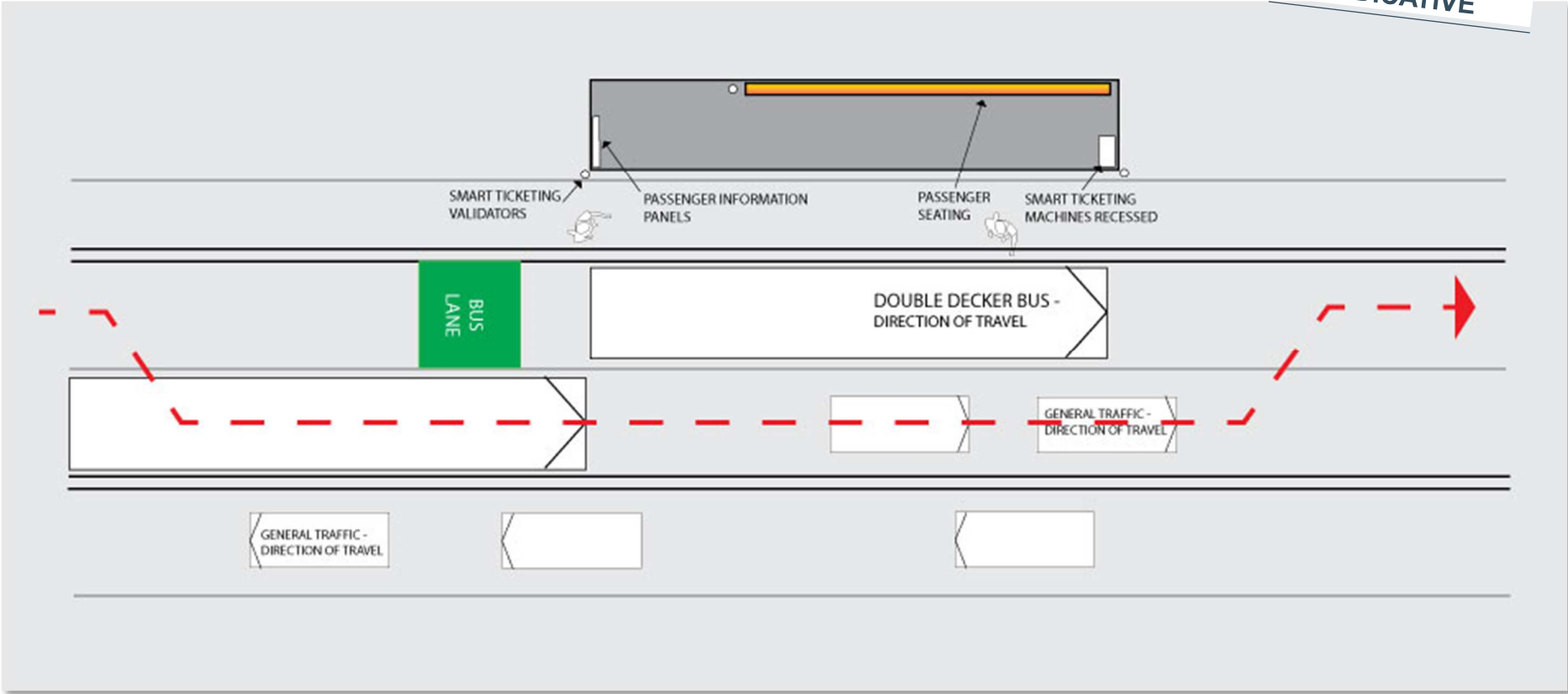



# Illustration of accommodating express services (2 of 4)

2 Having 'express' buses pass 'all stops' ABS vehicles stopped at stations by going into the opposing lanes of median stations with side platform, parallel or lateral offset stations

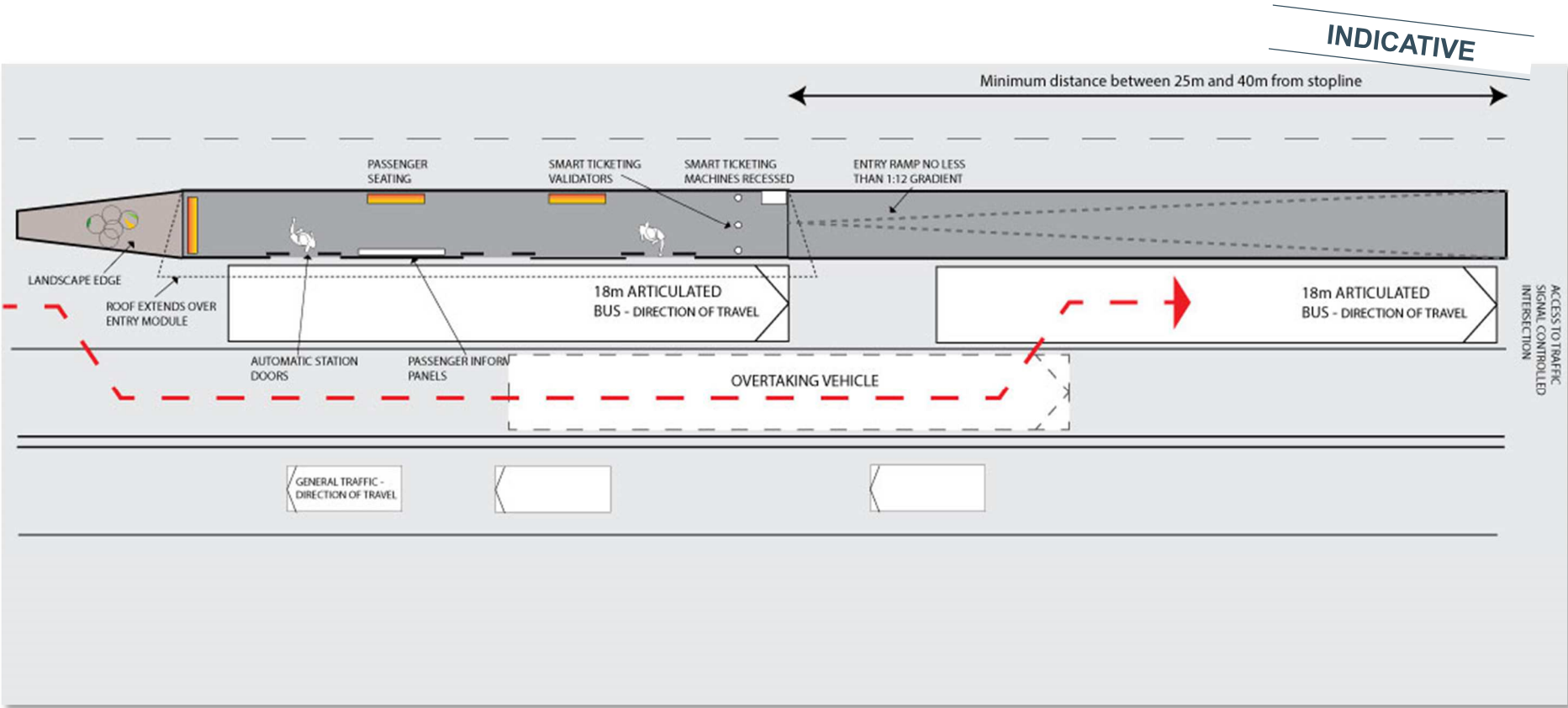

# Illustration of accommodating express services (3 of 4)

3

Having 'express' buses pass around 'all stops' ABS vehicles in the mid-block sections where there are no stations and there are parallel ABS lanes that are only separated by road markings, which would be the main options for the Dominion Rd services as there is a consistent central ROW for AART and AART+

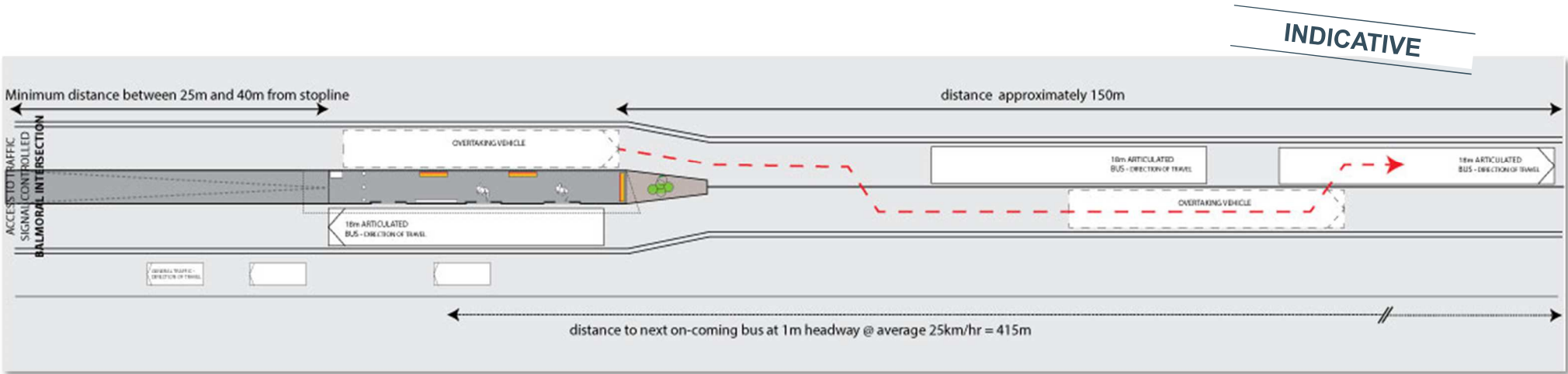

# Illustration of accommodating express services (4 of 4)

4

Establishing areas at either end of median stations where 'all stops' ABS vehicles could 'hold' while 'express' buses pass around them, which is easily achieved with the use of the advanced fleet management, which would be required and expected as part of the ABS

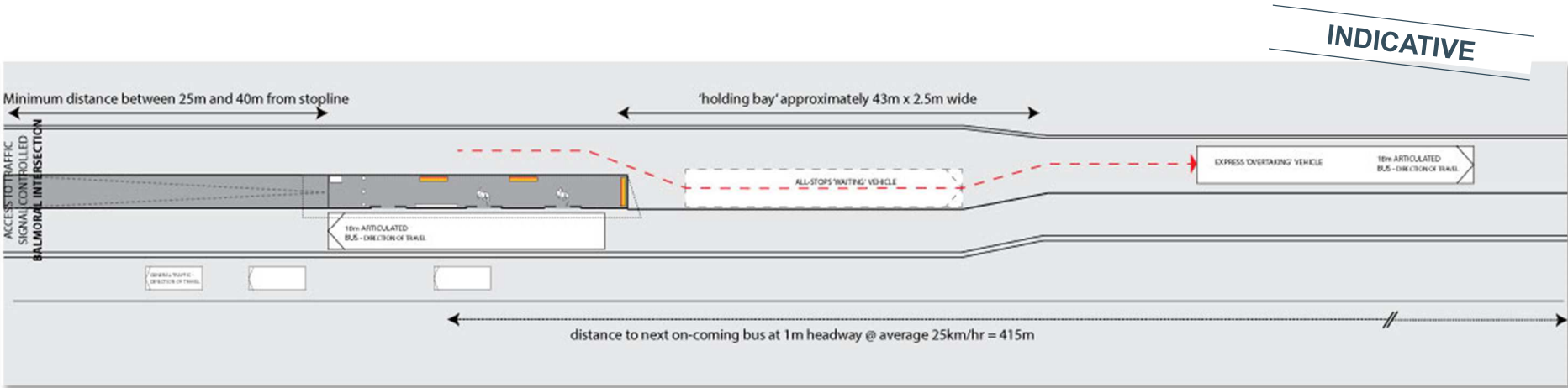

## Short term 'layover' facilities on Commerce St could be considered further

- A normal bus layover might provide drivers space to park buses and prepare services between journeys; and provide amenities for drivers, such as a WC or break room. The time a bus spends in a bus layover varies significantly from a few minutes to an hour depending on services and driver needs
- The positioning of bus layover facilities can assist in minimising 'dead running' and, in the case of the ABS, are developed such that the least amount of impact on the CBD is created. Although it is intended to minimise layover at this sensitive location, it is not practical to move all operational layover away from the city centre because of the impact it will have on service times and reliability, and interchange and accessibility
- Prior to the CRL works, the Commerce St bus stops (near Tyler St and near Galway St) operated a number of routes (i.e. bus route number 550X, 551X, 553X and 554X – *all presently provided for on Customs St East stops*)
- For the ABS, the proposal would be to provide for two to four layover spaces in the Quay St and Customs St block (between Galway St and Tyler St – 60m of space) and these would be suitable for the requirements of the ABS

## Short term 'layover' facilities in Commerce St: 2-4 layover spaces in the Quay St and Customs St block

CBD layover  
optimisation

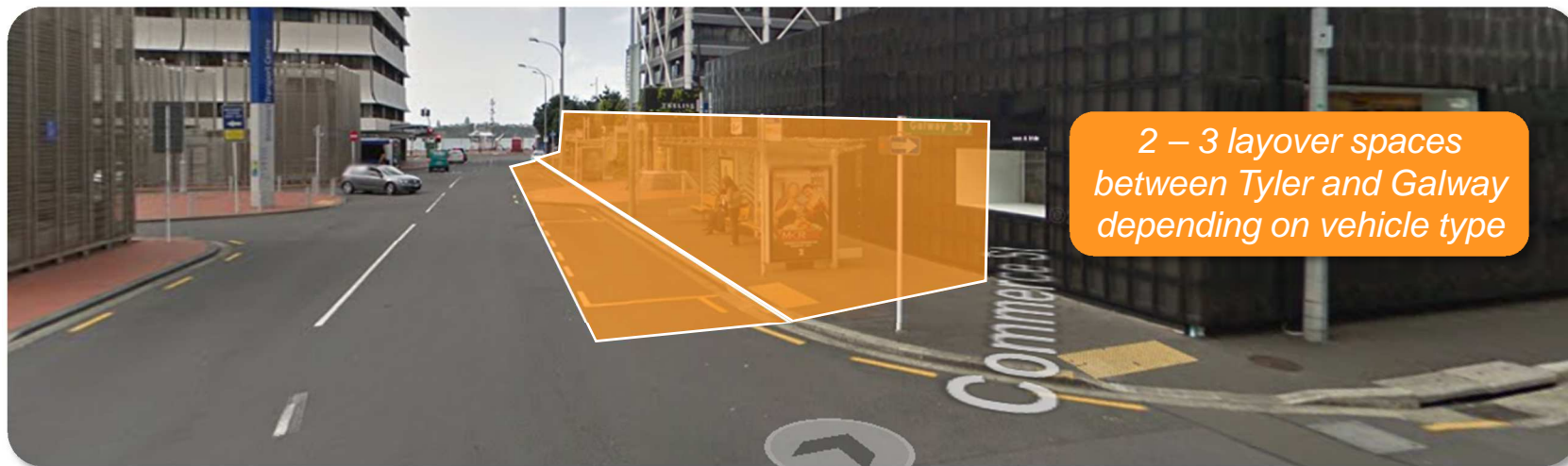
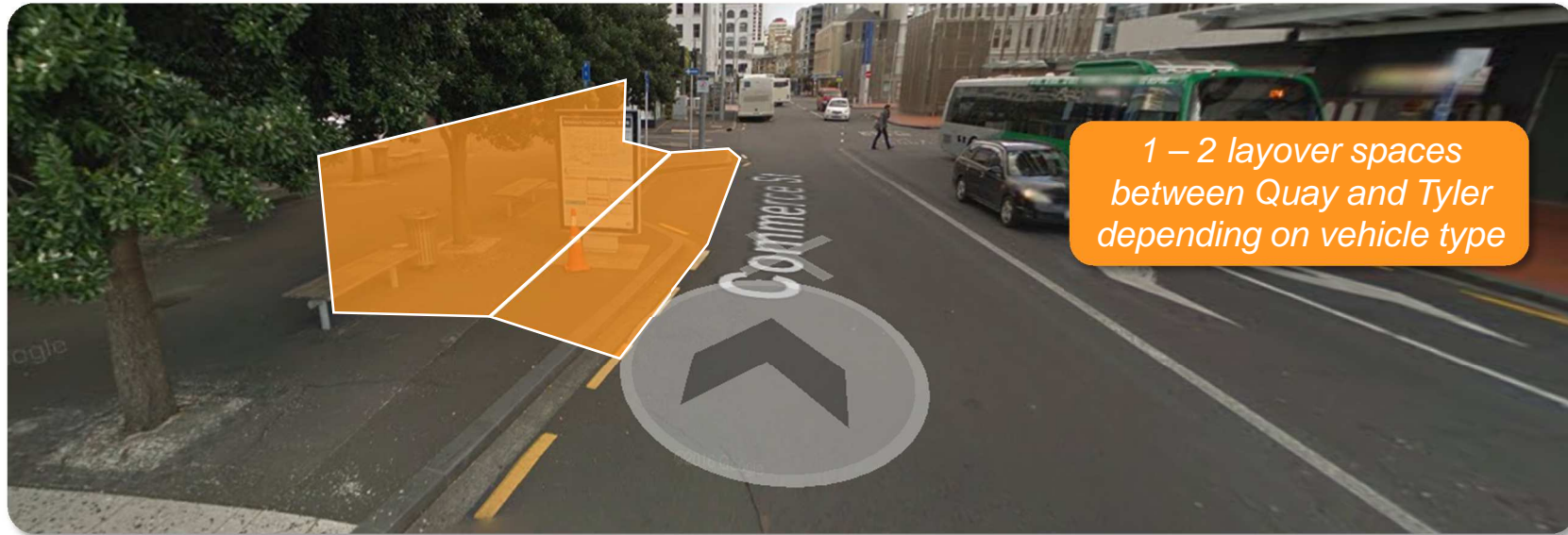

Source: L.E.K. team expert interviews

## Traffic management – Traffic Signal Priority for buses

---

- Detailed analysis will be required to assess and develop appropriate mitigation strategies for both general traffic, for example at major east-west intersections, and bus traffic more specifically (e.g. intersection micro-simulation analysis), *accounting for advanced ITS technologies* such as fleet management, signal priority, precision docking, etc.
- *Traffic signal priority for ABS* buses and the demand for pedestrians to access the stations, as well as integrate with the other key PT interchanges such as Wellesley St, Britomart, Aotea, Onehunga and Newmarket

# Traffic management – Traffic Signal Priority for buses

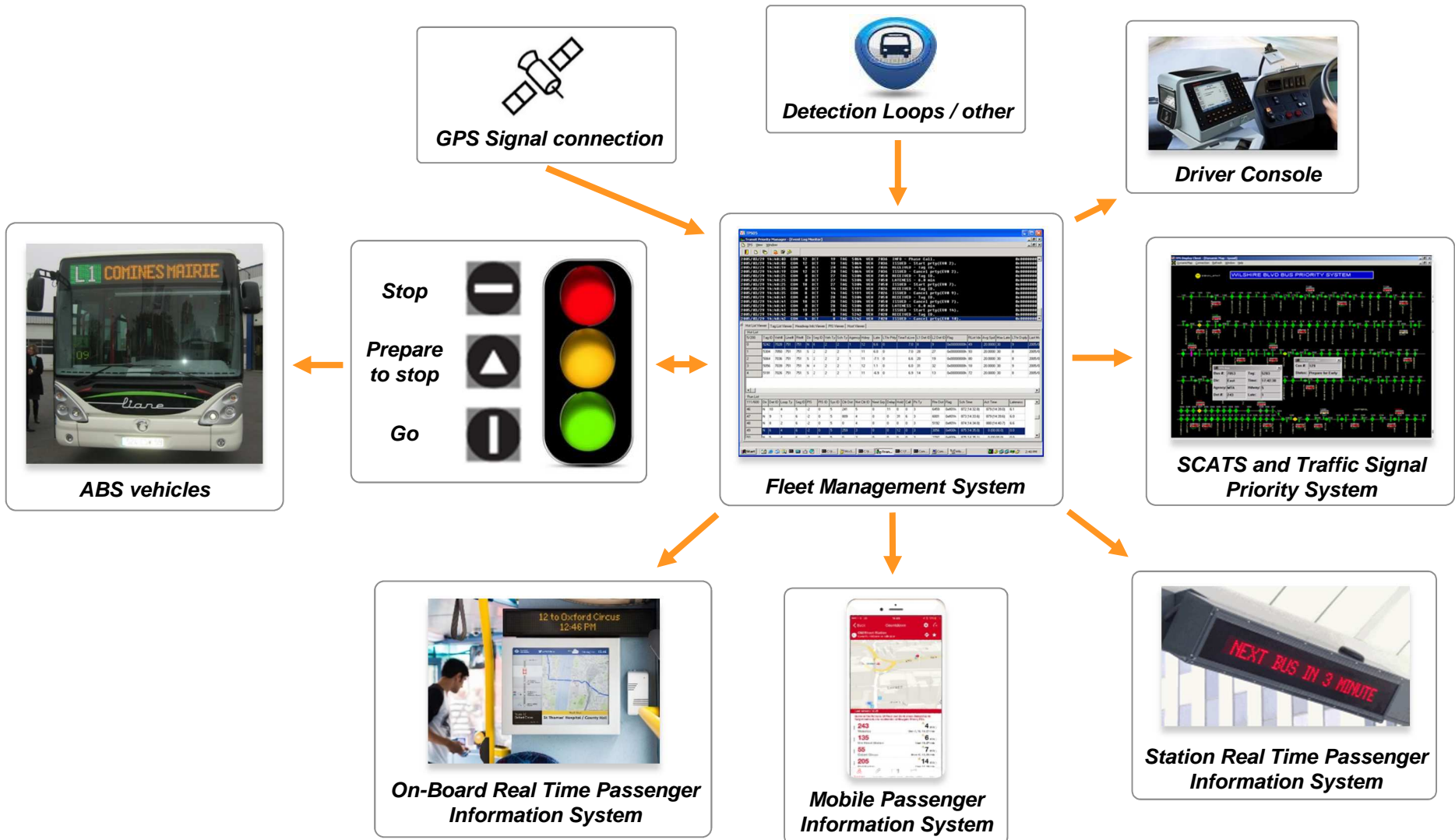

# Traffic management – Traffic Signal Priority for buses

Options for ABS signal priority:

1 **Early green**  
- vehicle detection required;  
**Red truncation**

2 **Green extension**  
- vehicle detection required;  
**Extend green phase**

3 **Call Phase**  
- late running, or  
- right turn in the route

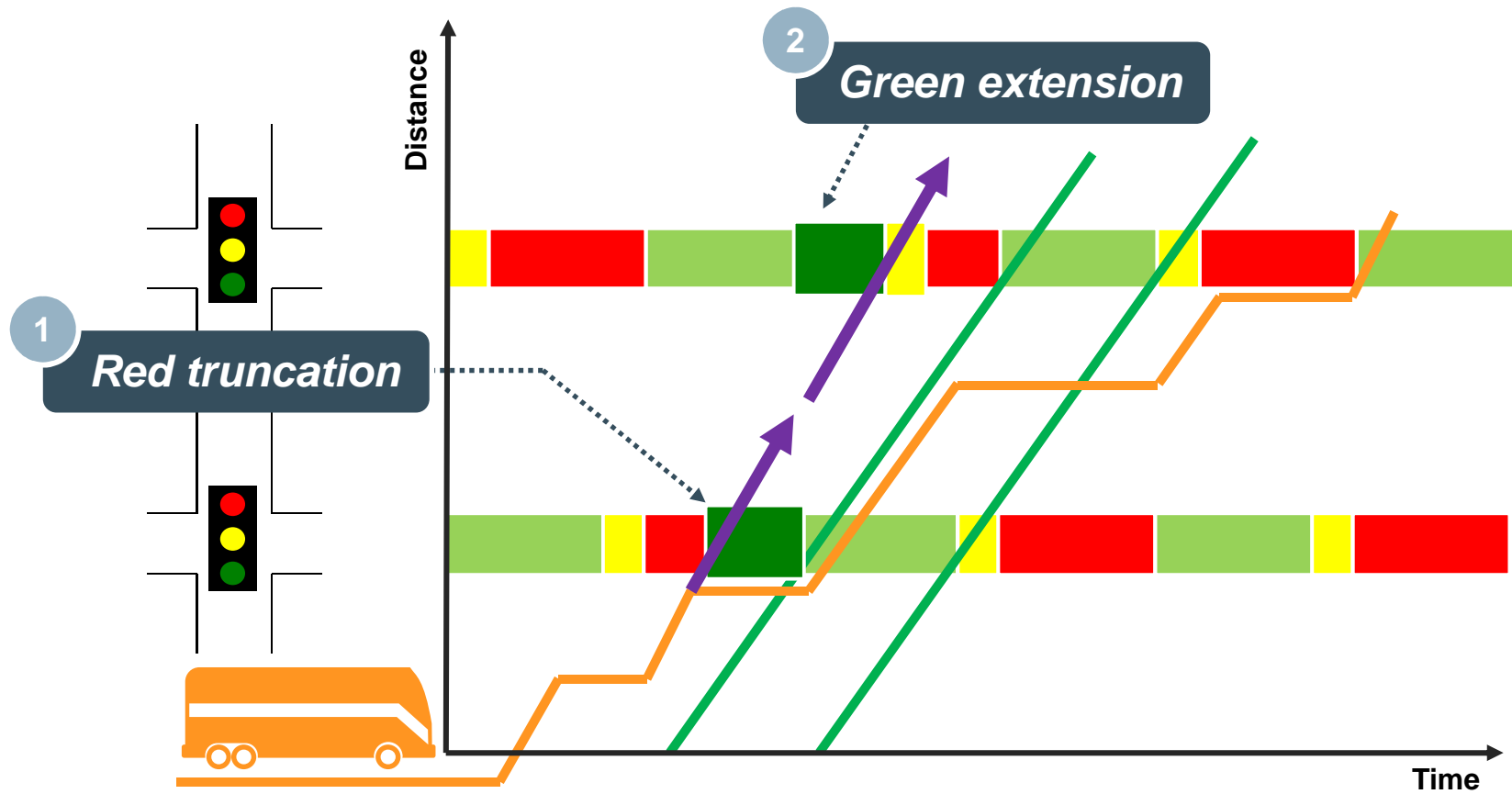



## Vehicle types and the opening year technology question?

---

- The client team requested further information on electric buses, including:
  - what about consideration of the distance that can be covered by electric buses?
  - how many return trips will they be able to do?
  - what is the consideration of this in terms of buses required (for when other buses are being recharged)?
- The technology is still in development; however, a new generation of solutions for electric buses are now in demonstration in a wide range of cities in Europe cities (such as London, Barcelona, Prague and Bremen) and many others have committed to changing their fleets to electric buses
- Presently, there are at least three different electric buses with 50-100km plus range (e.g. Solaris, BYD, Van Hool). These are available with 'fast charging' capability
  - 'fast charging' is a compact roadside facility that allows the battery to restore to 60-80% of charge in less than 10 minutes, meaning it can be done during a stand layover at the end-point of a route. Barcelona is currently demonstrating this and as such no additional buses are required to allow for the recharge time
- Volvo and others make hybrid-electric buses that can travel 5-10km without the engine on or even further with it at idle
- We (AT and NZTA) should consider that within a few years we will have reliable production-line electric buses that can give us a full day of operation, perhaps with quick-recharge facility

## Case study (1 of 7)



**An 18m BYD articulated bus on its way to Medellin from Bogota**

***On 16<sup>th</sup> March 2016, an 18m articulated pure electric BYD bus covered a distance of over 400km between Bogota and Medellin with one single battery charge, in a nonstop test preparation journey of the BYD zero emission bus to initiate Medellin. The topography of Medellin is characterised by frequent and often exceedingly steep slopes, and this successful journey was the first step to prove BYD's mature technology to provide reliable electrified public transportation. With capacity for 150 passengers, this is the largest pure electric bus ever built and is configured for the many cities***

## Case study (2 of 7)



*Two new electric articulated buses were presented on 21<sup>st</sup> September 2016 in Barcelona within the ZeEUS (Zero Emission Urban bus System) project framework*

*The new buses, two articulated Solaris Urbino E, are the first 18m pure electric vehicles in Spain and are able to charge batteries while en route at a station built specially by Endesa in the Zona Franca, near the end of bus route H16, where these buses will be operating*

*Built in Poland by Solaris, these 110-passenger capacity buses are powered by 270kW electric motors and equipped with three two-speed batteries – slow charging at the garage and rapid charging en route. As a result, the bus is able to perform well with smaller batteries (120kWh) and less weight, which makes it more efficient*

## Case study (3 of 7)



*The new Van Hool Exqui.City trambus is 18.61m long, carries between 107 and 140 passengers and has a range of 120km*

*This fully electric trambus is equipped with a lithiumion battery, which has a storage capacity of 215 kWh. This battery enables a range of 120km. The battery powers two electric watercooled Siemens 160kW central motors, and is mounted on the roof and can be charged conductively in two ways*

*It can be charged by an external pantograph (installed at the terminus) that is lowered from above onto insulated Vshaped charging rails on the roof of the vehicle. This 'fast charge' takes no more than 10 minutes. Alternatively, the vehicle can be connected up to the electricity grid by plugging a connector in the front of the vehicle into a designated power outlet; this is done outside service hours and usually overnight in the depot*

## Case study (4 of 7)

Vehicle type /  
propulsion



***SMRT Dennis Enviro500 MMC bus:*** In April 2014, SMRT announced the purchase of 201 new Alexander Dennis Enviro500 MMC 12-metre buses, as part of a fleet renewal and expansion initiative by SMRT Buses

***Euro-V compliant – Selective Catalytic Reduction (SCR) technology requiring diesel exhaust fluids such as AdBlue***

***Licensed capacity: 134 passengers (55 upper deck seating, 28 lower deck seating and 51 standing with one wheelchair bay)***

Source: SMRT technical specification data

## Case study (5 of 7)



***SMRT MAN A24 (MAN's Lion City G): Introduced as a demonstrator trial in 2013 and now operating in over 40 vehicles on multiple routes in the city since 2015. Operates a turbocharged & Intercooled, 10518cc, 360 hp (265 kW) Euro V-compliant engine with exhaust Gas Re-circulation (EGR) technology combined with MAN's own PM-Kat® exhaust treatment system, hence doing away with the need for diesel exhaust fluids***

***Capacity: Up to 140 passengers (up to 55 seated, up to 85 standing)***

Source: SMRT technical specification data

## Case study (6 of 7)



***The Mercedes-Daimler O 350 Tourismo: The specification is a length of 19.5 m, width of 2.55m and an interior height of 2.3m***

***The vehicle operates a Euro V engine with Selective Catalytic Reduction (SCR) technology requiring diesel exhaust fluids such as AdBlue***

***Capacity: 193 total (43 seated and 150 standing)***

Source: Adapted from Presentations by the World Bank Resources Institute and EMBARQ

## Case study (7 of 7)



***Phileas bi-articulated diesel–electric buses:*** The specification is a length of 26 m, width of 2.54m and an interior height of 2.25m. Istanbul Metropolitan Municipality purchased 50 Phileas bi-articulated vehicles for the Metrobus project in 2010

***Capacity: 230 total (50 seated and 180 standing)***

Source: Adapted from Presentations by the World Bank Resources Institute and EMBARQ



## There are a number of additional steps that need to be taken to further develop AART and AART+ for the business case development process

<b><i>Integrated service planning</i></b>	<ul style="list-style-type: none"> <li>● Integration and optimisation required for the ABS network and the New Network solution, such that PT patronage can be maximised whilst meeting appropriate levels of customer amenity</li> </ul>
<b><i>Overtaking</i></b>	<ul style="list-style-type: none"> <li>● For both AART and AART+ the service plan proposals used for the base assessment have sought to utilise all stops and express services such that passing will be required; as such this presentation includes some additional visualisation of these options – however the use of a microsimulation or detailed animation package may be required to aid operational understanding in the future</li> </ul>
<b><i>CBD layover optimisation</i></b>	<ul style="list-style-type: none"> <li>● Identified strategies to minimise and/or optimise the CBD layovers through a range of initiatives (e.g. utilising airport layovers, CBD through running, virtual layovers, etc.) require further evaluation</li> <li>● Overnight storage of a number of buses are required for the 5am start time from Queen St and this would need to be associated with the ability to re-fuel and clean vehicles as necessary</li> </ul>
<b><i>Traffic management</i></b>	<ul style="list-style-type: none"> <li>● Further detailed analysis will be required to understand and develop appropriate mitigation strategies for both general traffic and bus traffic more specifically (e.g. intersection micro-simulation analysis), accounting for advanced ITS technologies</li> <li>● Integration of the proposals with the cycle network and provision for cycle parking at key interchanges where park and ride is proposed</li> </ul>
<b><i>Vehicle type / propulsion</i></b>	<ul style="list-style-type: none"> <li>● Timing for technology shifts in propulsion requires detailed analysis into the pro's and con's of the opening year choices versus the 2036 or 2046 requirements; e.g. full electric vehicles are heavier than hybrid electric due to larger batteries and this may mean axle loadings are exceeded with less passengers</li> <li>● Service planning may include removal of full electric in off peak times and operate in peak hours only</li> <li>● Larger scale buses are being developed to meet urban demand for BRT and exceed now 300 passengers, such proposals may provide significant rapid transit capacity without high frequencies</li> </ul>
<b><i>Route alignment and stop location</i></b>	<ul style="list-style-type: none"> <li>● Further analysis and review should be completed to “fine tune” AART (e.g. to optimise demand, minimise any adverse general traffic impacts – potentially confirmed via intersection micro-simulation modelling, etc.)</li> <li>● Consideration of the opportunity for grade separation of major east – west intersections and routes for reduced conflict with ABS buses</li> </ul>
<b><i>Demand modelling</i></b>	<ul style="list-style-type: none"> <li>● Further model runs are likely to be appropriate to optimise expected demand, having regard to the impact on the assessed economic merit via the CBA</li> </ul>
<b><i>CBA and MCA</i></b>	<ul style="list-style-type: none"> <li>● It is likely that many of the cost and benefit line items derived for the preferred advanced bus option will require further refinement before being “fit for purpose” for comparison against any alternative rapid transit proposal</li> </ul>
<b><i>PTOM</i></b>	<ul style="list-style-type: none"> <li>● Further work needs to be done to consider the options for longer term contracts for vehicles that may pass the functional maximum for the operator, e.g. the vehicle is resold to the next operator at the end of the 10 year operations contract at a price negotiated by AT Metro and the operators involved</li> </ul>