

PLAN SET K

Waitarere Beach Road Curves Project Cross Sections

Prepared for The New Zealand Transport Agency

November 2015



MWH[®]

BUILDING A BETTER WORLD

DO NOT SCALE - IF IN DOUBT, ASK

200 mm
150
100
90
80
70
60
50
40
30
20
10
0

ORIGINAL SIZE A1

EAST SIDE
(TYPICAL ALL SHEETS)

WEST SIDE
(TYPICAL ALL SHEETS)

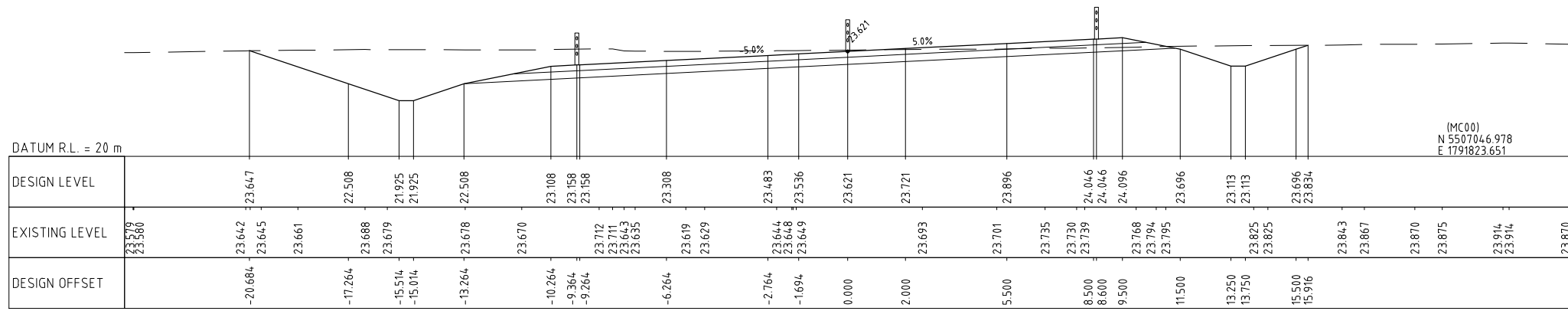

STATION 5720

INDICATES EXISTING ROAD SURFACE
INDICATES EXISTING GROUND SURFACE

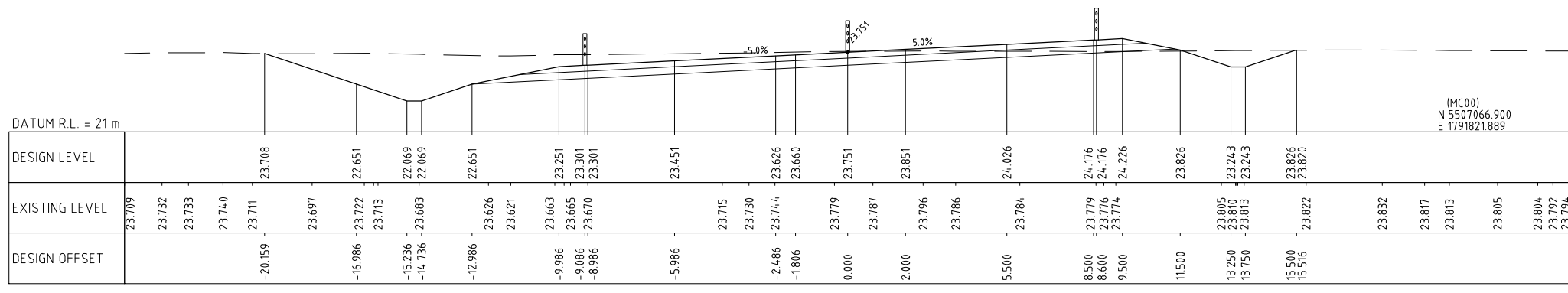

STATION 5700

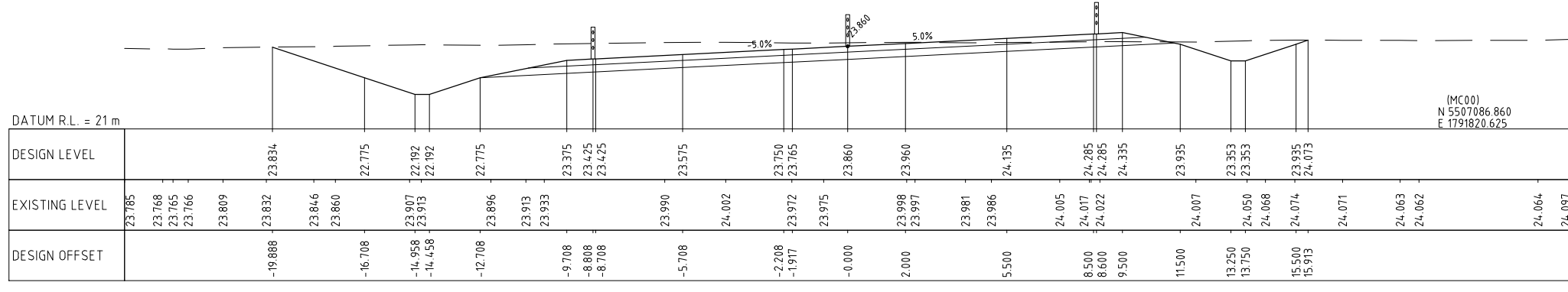

STATION 5680

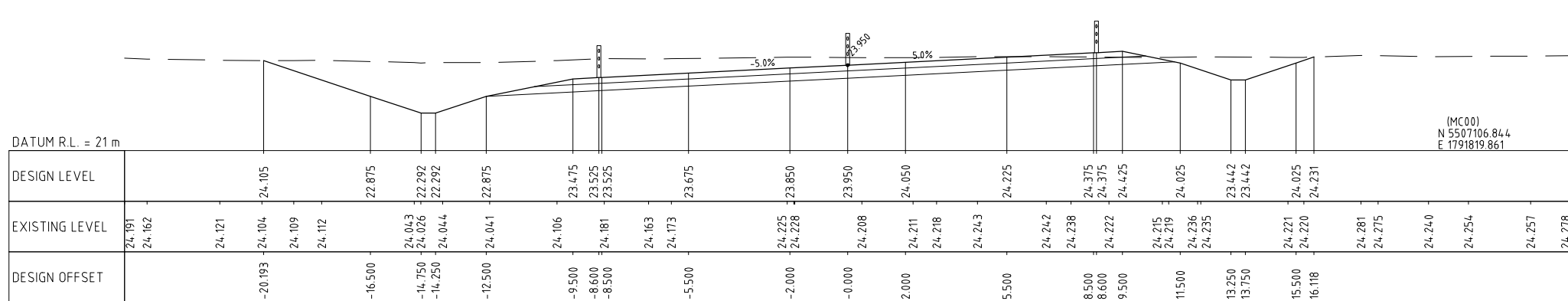

STATION 5660

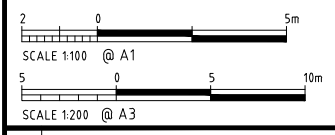

REV	DESCRIPTION	P/J	J/P	PP	DATE
B	ISSUE FOR CONSENT	PJC	JP	PP	11/15
A	FOR CONSULTATION	PJC	JP	PP	09/15
REV	REVISIONS	DRN	CHK	APP	DATE

SURVEYED	LIDAR & Aerial Photos	04/14
DESIGNED	Barbara Browne	06/14
DRAWN	Phillip Cook	06/14
CAD REVIEW		
DESIGN CHECK		
DESIGN REVIEW		
APPROVED		
PROF REGISTRATION		

Client:

**WAITARERE BEACH ROAD
CURVES PROJECT**

CROSS SECTIONS

Status Stamp	FOR CONSENT
Date Stamp	12/11/2015
Scales	1:100 @A1, 1:200 @A3
Drawing No.	80500902-04-0853-C908
Rev	B

NOT FOR CONSTRUCTION

EAST SIDE
(TYPICAL ALL SHEETS)

WEST SIDE
(TYPICAL ALL SHEETS)

DO NOT SCALE - IF IN DOUBT, ASK

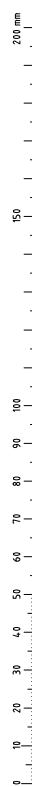

ORIGINAL SIZE A1

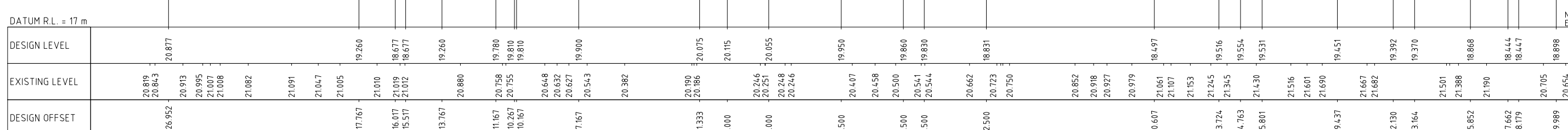
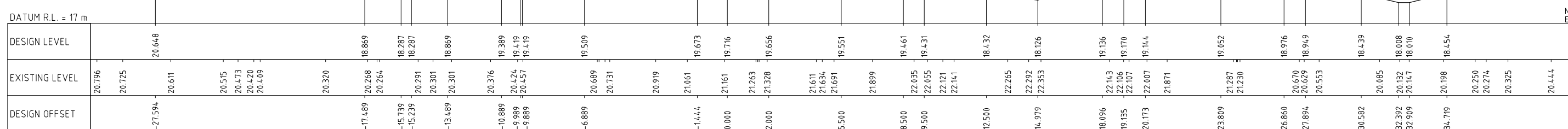
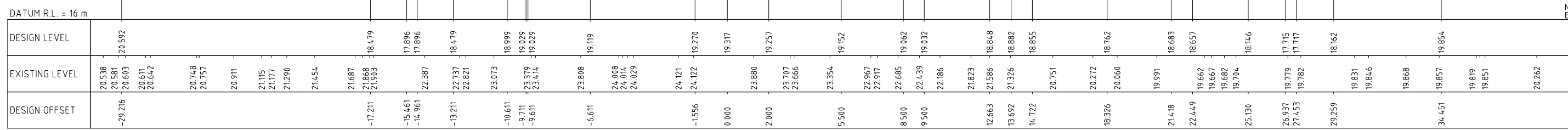

INDICATES EXISTING ROAD SURFACE
INDICATES EXISTING GROUND SURFACE

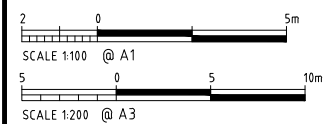

NOT FOR CONSTRUCTION

REV	DESCRIPTION	P/J	J/P	PP	11/15
B	ISSUE FOR CONSENT	P/J	J/P	PP	11/15
A	FOR CONSULTATION	P/J	J/P	PP	09/15
REV	REVISIONS	DRN	CHK	APP	DATE

SURVEYED	LIDAR & Aerial Photos	04/14
DESIGNED	Barbara Browne	06/14
DRAWN	Phillip Cook	06/14
CAD REVIEW		
DESIGN CHECK		
DESIGN REVIEW		
APPROVED		
PROF REGISTRATION		

Client:

WAITARERE BEACH ROAD
CURVES PROJECT

CROSS SECTIONS

Status Stamp	FOR CONSENT
Date Stamp	12/11/2015
Scales	1:100 @A1, 1:200 @A3
Drawing No.	80500902-04-0853-C912
Rev	B

DO NOT SCALE - IF IN DOUBT, ASK

ORIGINAL SIZE **A1**

SCALE 1:100 @ A1

SCALE 1:200 @ A3

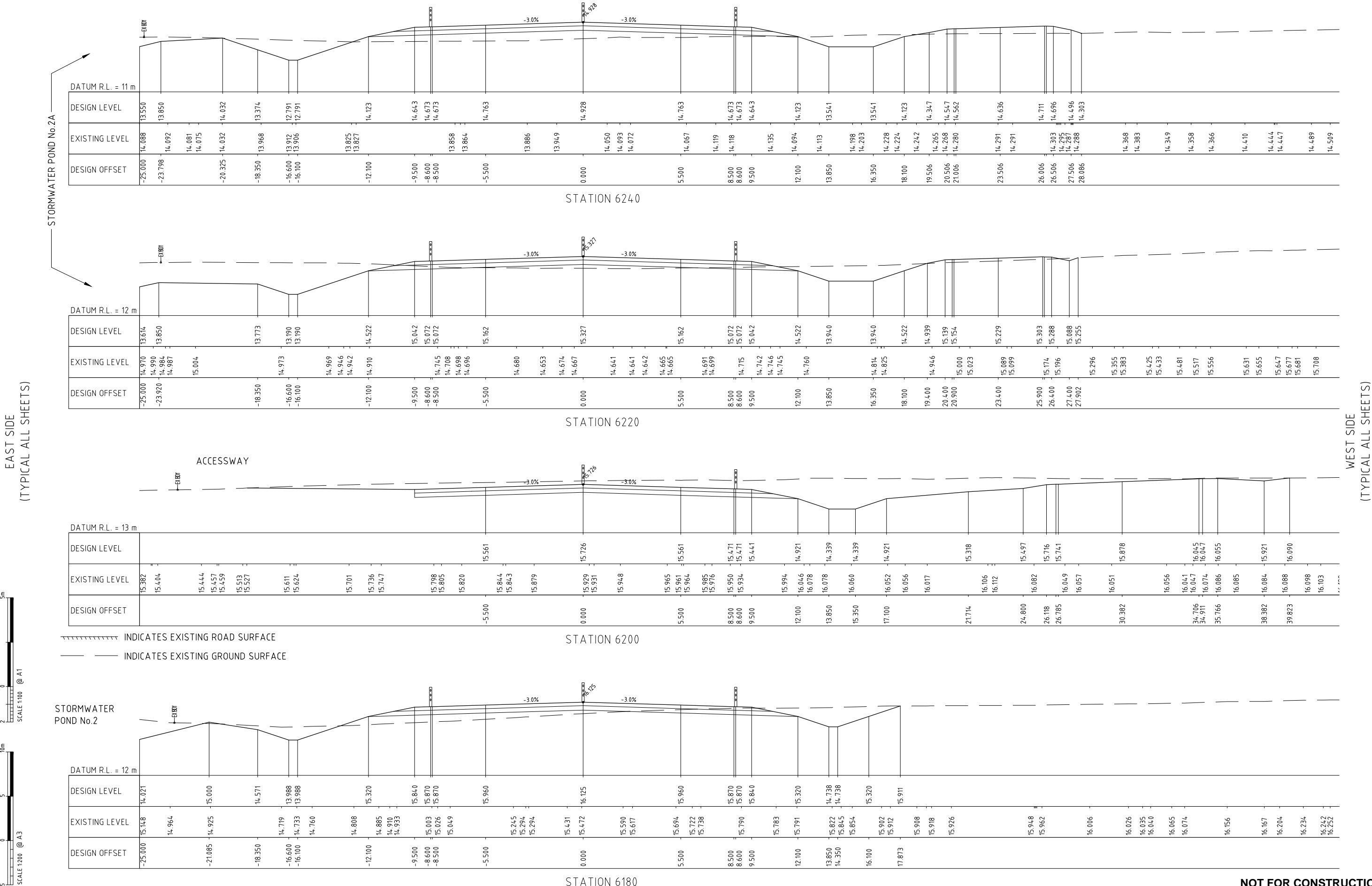

REV	ISSUE FOR CONSENT	P/J	J/P	PP	11/15
A	FOR CONSULTATION	P/J	J/P	JP	09/15
B	ISSUE FOR CONSENT	DRN	CHK	APP	DATE

SURVEYED	LIDAR & Aerial Photos	04/14
DESIGNED	Barbara Browne	06/14
DRAWN	Phillip Cook	06/14
CAD REVIEW		
DESIGN CHECK		
DESIGN REVIEW		
APPROVED		
PROF REGISTRATION		



Client:
WAITARERE BEACH ROAD CURVES PROJECT

CROSS SECTIONS	
Status Stamp	FOR CONSENT
Date Stamp	12/11/2015
Scales	1:100 @A1, 1:200 @A3
Drawing No.	80500902-04-0853-C915
Rev	B

NOT FOR CONSTRUCTION

ORIGINAL SIZE A1
SCALE 1:100 @ A1
SCALE 1:200 @ A3

DO NOT SCALE - IF IN DOUBT, ASK

EAST SIDE
(TYPICAL ALL SHEETS)

WEST SIDE
(TYPICAL ALL SHEETS)

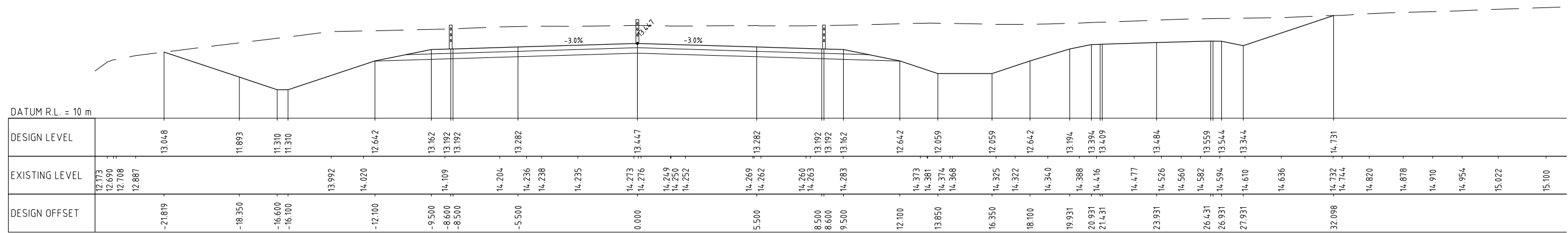

STATION 6320

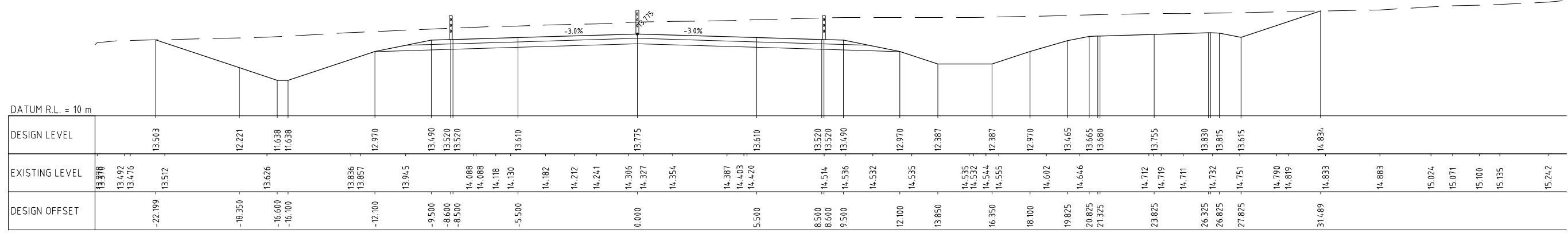

STATION 6300

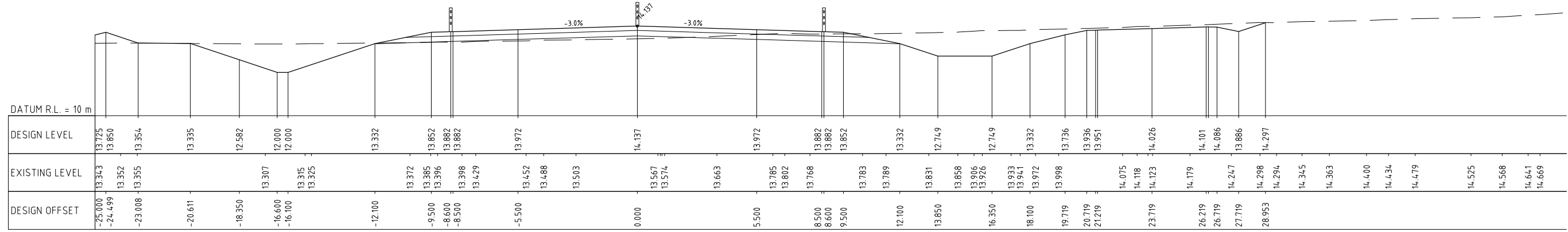

STATION 6280

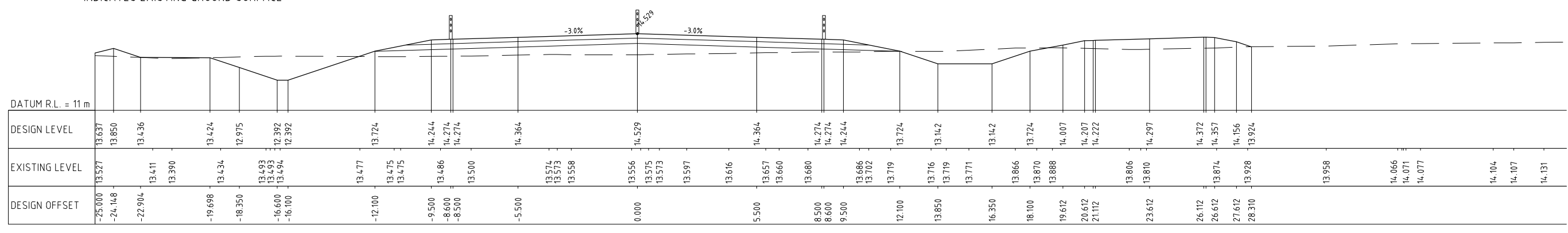

STATION 6260

INDICATES EXISTING ROAD SURFACE
INDICATES EXISTING GROUND SURFACE

NOT FOR CONSTRUCTION

REV	DESCRIPTION	P/J	J/P	PP	11/15
B	ISSUE FOR CONSENT	PJC	JP	PP	11/15
A	FOR CONSULTATION	PJC	JP	PP	09/15
REV	REVISIONS	DRN	CHK	APP	DATE

SURVEYED	LIDAR & Aerial Photos	04/14
DESIGNED	Barbara Browne	06/14
DRAWN	Phillip Cook	06/14
CAD REVIEW		
DESIGN CHECK		
DESIGN REVIEW		
APPROVED		
PROF REGISTRATION		



Client: WAITARERE BEACH ROAD CURVES PROJECT
CROSS SECTIONS

Status Stamp	FOR CONSENT
Date Stamp	12/11/2015
Scales	1:100 @A1, 1:200 @A3
Drawing No.	80500902-04-0853-C916
Rev	B

DO NOT SCALE - IF IN DOUBT, ASK

200 mm
150
100
90
80
70
60
50
40
30
20
10
0

ORIGINAL SIZE A1

EAST SIDE
(TYPICAL ALL SHEETS)

WEST SIDE
(TYPICAL ALL SHEETS)

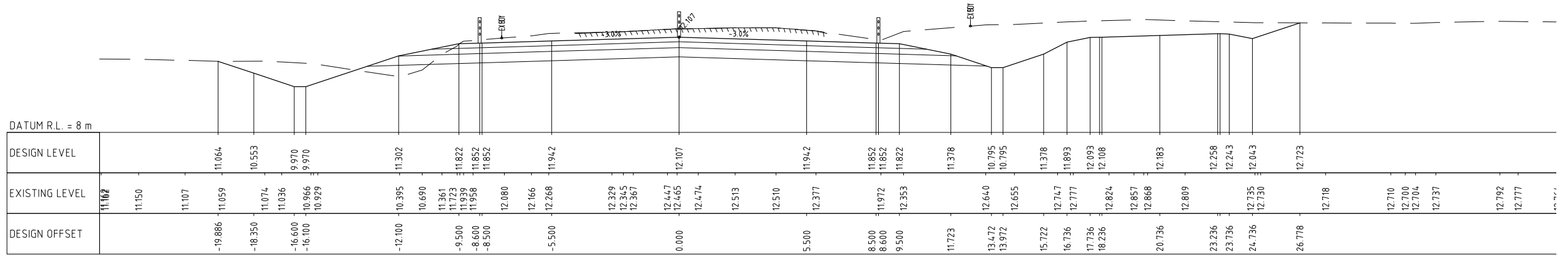

STATION 6560

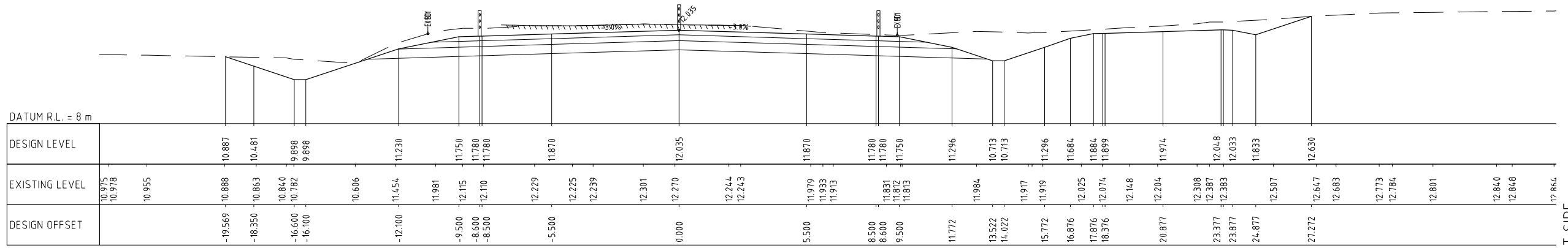

STATION 6540

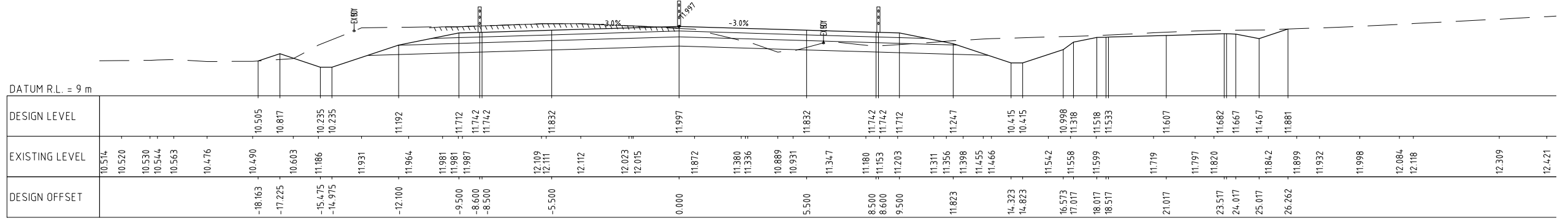

STATION 6520

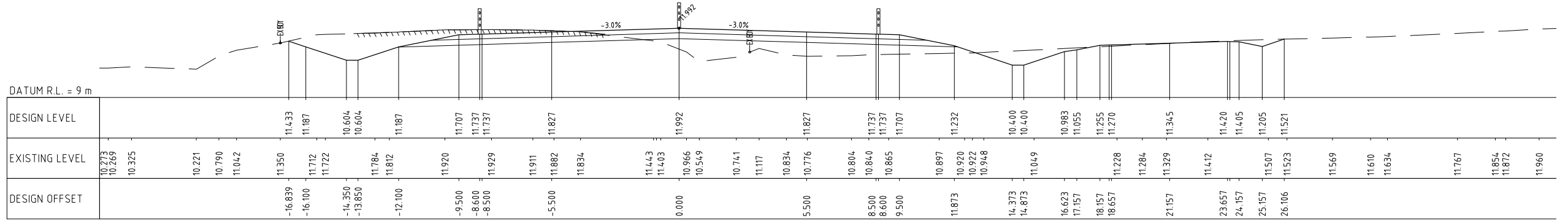

STATION 6500

INDICATES EXISTING ROAD SURFACE
 INDICATES EXISTING GROUND SURFACE

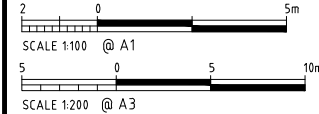

REV	DESCRIPTION	P/J	J/P	PP	DATE
B	ISSUE FOR CONSENT	P/J	J/P	PP	11/15
A	FOR CONSULTATION	P/J	J/P	PP	09/15
REV	REVISIONS	DRN	CHK	APP	DATE

SURVEYED	LIDAR & Aerial Photos	04/14
DESIGNED	Barbara Browne	06/14
DRAWN	Phillip Cook	06/14
CAD REVIEW		
DESIGN CHECK		
DESIGN REVIEW		
APPROVED		
PROF REGISTRATION		

Client:

WAITARERE BEACH ROAD
 CURVES PROJECT
 CROSS SECTIONS

NOT FOR CONSTRUCTION	
Status Stamp	FOR CONSENT
Date Stamp	12/11/2015
Scales	1:100 @A1, 1:200 @A3
Drawing No.	80500902-04-0853-C919
Rev	B

DO NOT SCALE - IF IN DOUBT, ASK

ORIGINAL SIZE **A1**
SCALE 1:100 @ A1
SCALE 1:200 @ A3

EAST SIDE
(TYPICAL ALL SHEETS)

WEST SIDE
(TYPICAL ALL SHEETS)

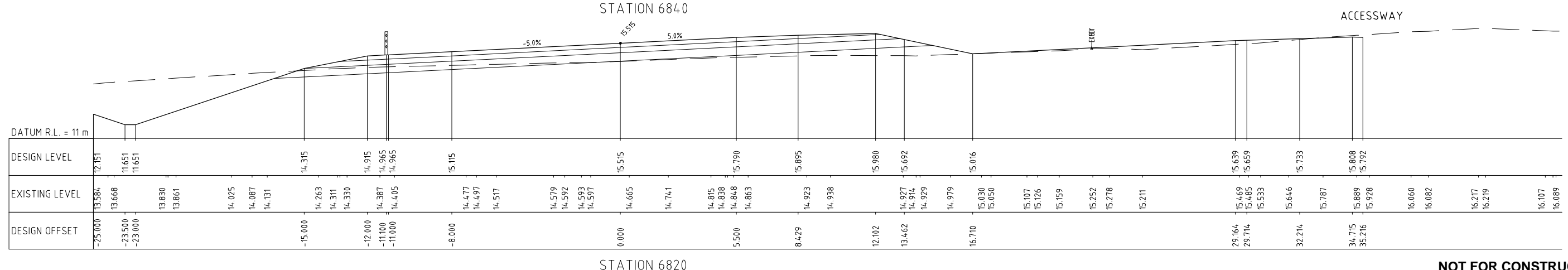
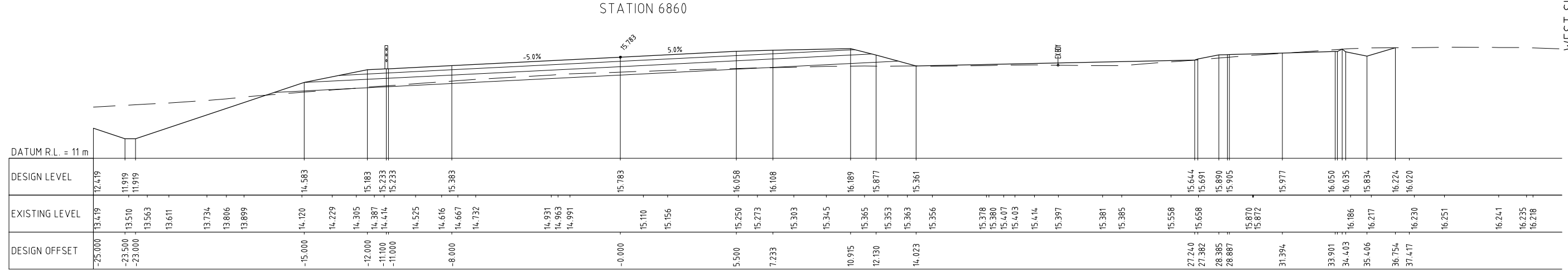
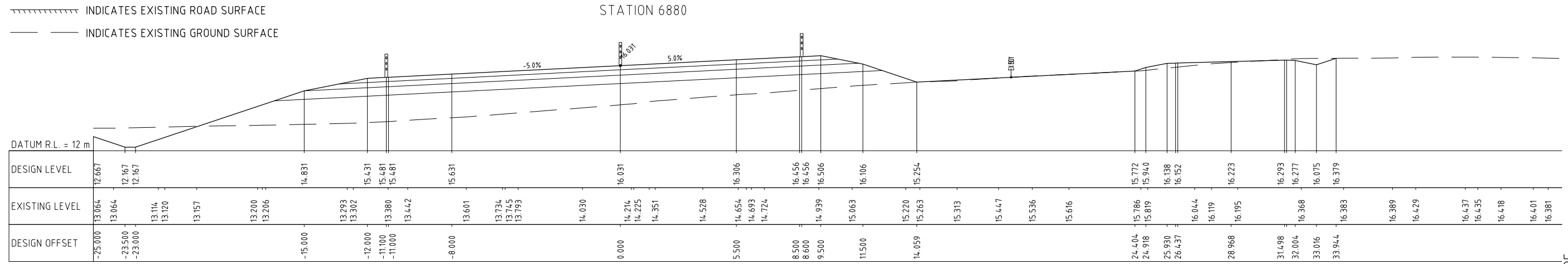
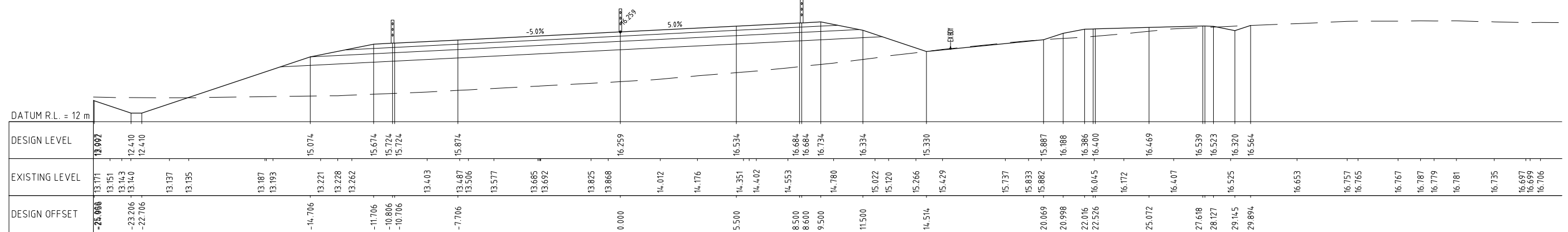

NOT FOR CONSTRUCTION

REV	ISSUE FOR CONSENT	P/J	J/P	PP	11/15
A	FOR CONSULTATION	P/J	J/P	JP	09/15
B	ISSUE FOR CONSENT	DRN	CHK	APP	DATE

SURVEYED	LIDAR & Aerial Photos	04/14
DESIGNED	Barbara Browne	06/14
DRAWN	Phillip Cook	06/14
CAD REVIEW		
DESIGN CHECK		
DESIGN REVIEW		
APPROVED		
PROF REGISTRATION:		



Client:
**WAITARERE BEACH ROAD
CURVES PROJECT**

CROSS SECTIONS

Status Stamp	FOR CONSENT
Date Stamp	12/11/2015
Scales	1:100 @A1, 1:200 @A3
Drawing No.	80500902-04-0853-C923
Rev	B

ORIGINAL SIZE A1
SCALE 1:100 @ A1
SCALE 1:200 @ A3



EAST SIDE
(TYPICAL ALL SHEETS)

WEST SIDE
(TYPICAL ALL SHEETS)

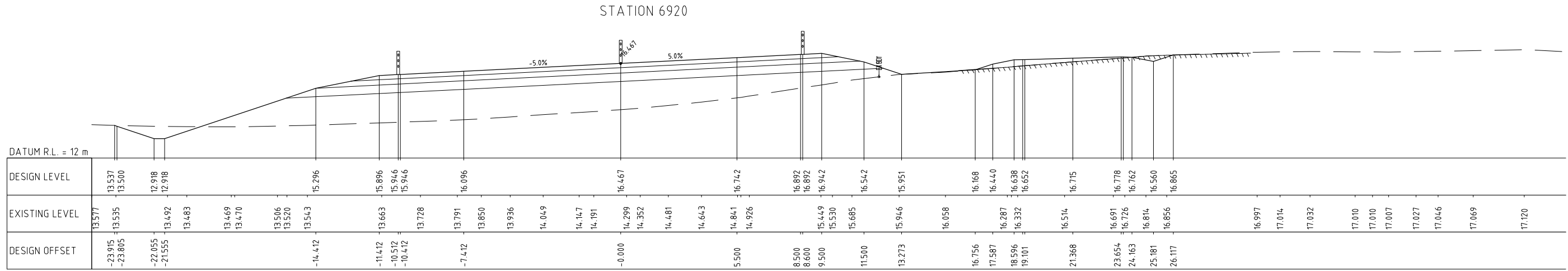
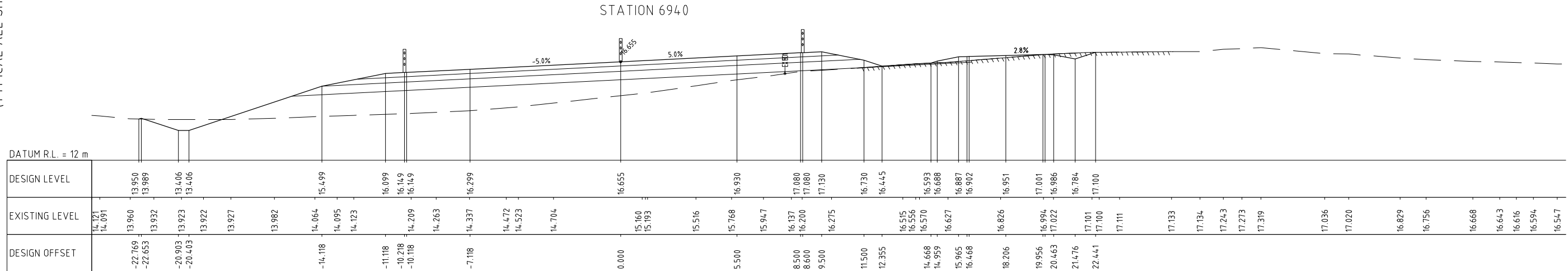
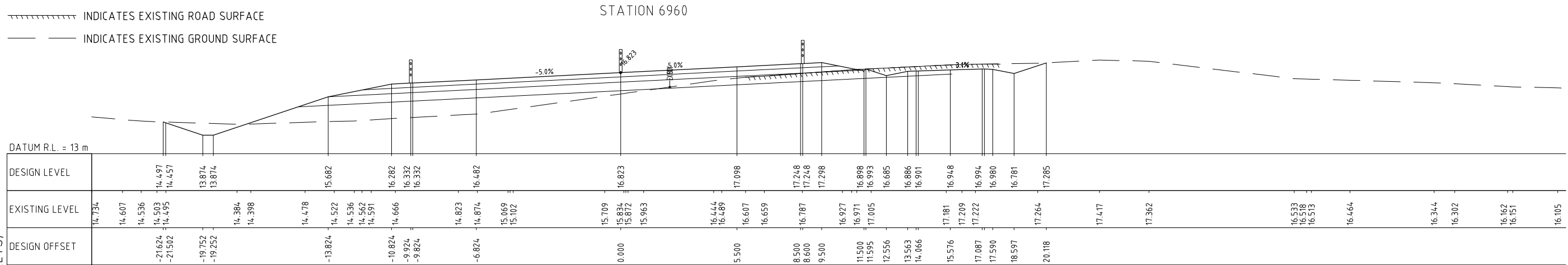
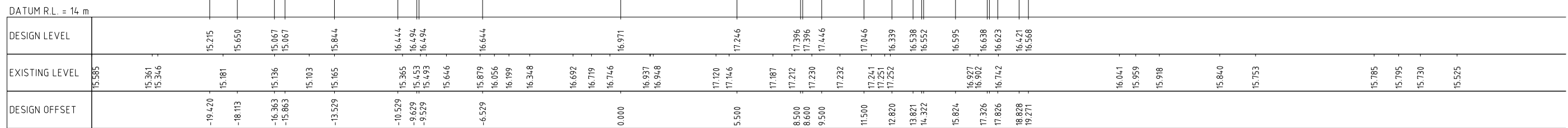

REV	DESCRIPTION	P/J	J/P	PP	11/15
B	ISSUE FOR CONSENT	P/J	J/P	PP	11/15
A	FOR CONSULTATION	P/J	J/P	PP	09/15
		DRN	CHK	APP	DATE

SURVEYED	LIDAR & Aerial Photos	04/14
DESIGNED	Barbara Browne	06/14
DRAWN	Phillip Cook	06/14
CAD REVIEW		
DESIGN CHECK		
DESIGN REVIEW		
APPROVED		
PROF REGISTRATION:		



Client: WAITARERE BEACH ROAD CURVES PROJECT

CROSS SECTIONS

Status Stamp	FOR CONSENT
Date Stamp	12/11/2015
Scales	1:100 @A1, 1:200 @A3
Drawing No.	80500902-04-0853-C924
Rev	B

NOT FOR CONSTRUCTION

ORIGINAL SIZE A1
SCALE 1:100 @ A1
SCALE 1:200 @ A3



EAST SIDE
(TYPICAL ALL SHEETS)

WEST SIDE
(TYPICAL ALL SHEETS)

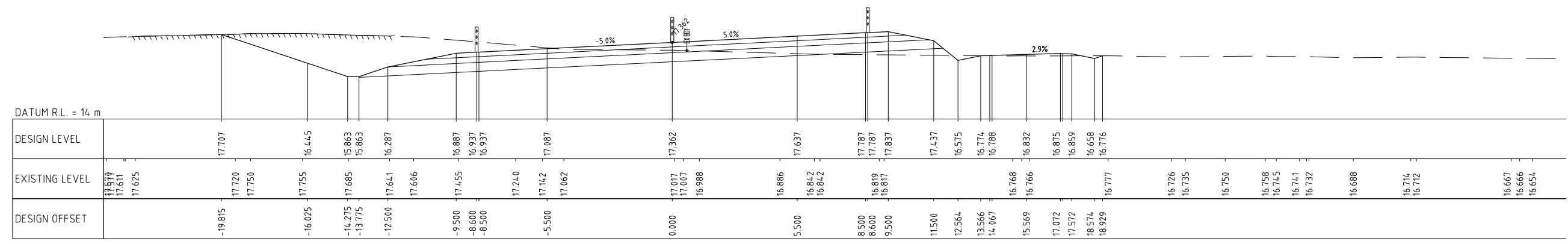

STATION 7040

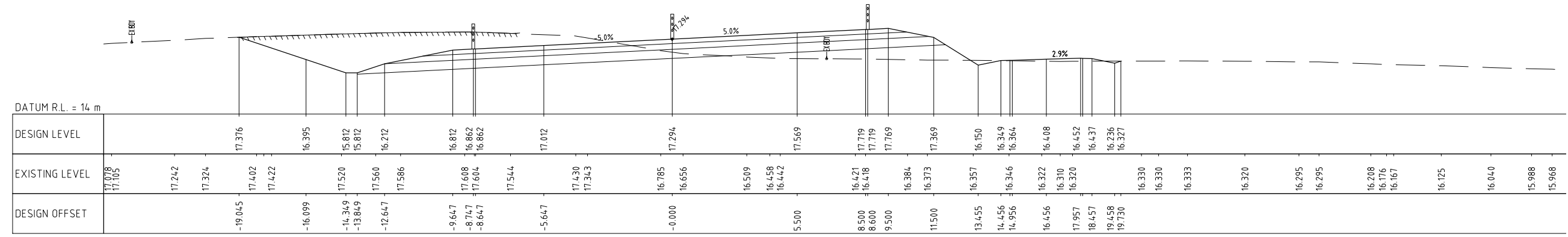

STATION 7020

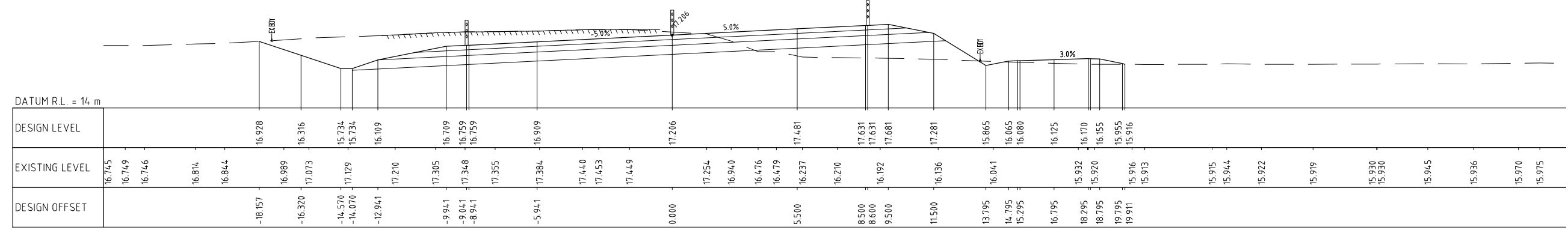

STATION 7000

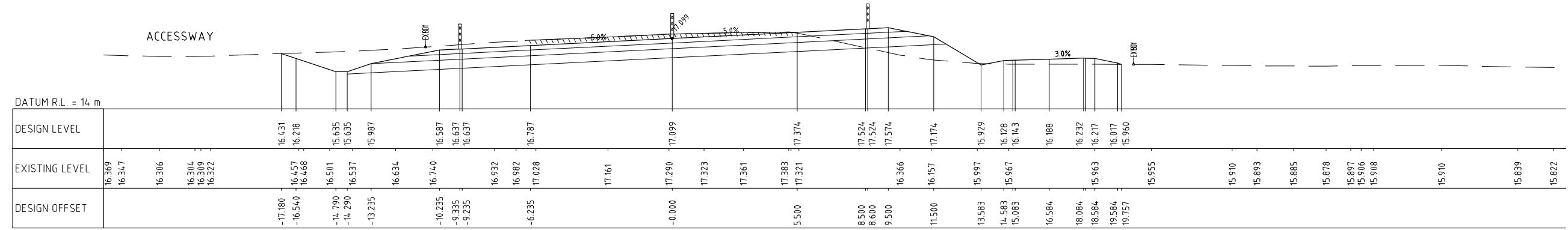

STATION 6980

INDICATES EXISTING ROAD SURFACE
INDICATES EXISTING GROUND SURFACE

NOT FOR CONSTRUCTION

REV	ISSUE FOR CONSENT	PJC	JP	PP	11/15
A	FOR CONSULTATION	PJC	JP	JP	09/15
	REVISIONS	DRN	CHK	APP	DATE

SURVEYED	LIDAR & Aerial Photos	04/14
DESIGNED	Barbara Browne	06/14
DRAWN	Phillip Cook	06/14
CAD REVIEW		
DESIGN CHECK		
DESIGN REVIEW		
APPROVED		
PROF REGISTRATION:		



Client:
**WAITARERE BEACH ROAD
CURVES PROJECT**

CROSS SECTIONS

Status Stamp	FOR CONSENT
Date Stamp	12/11/2015
Scales	1:100 @A1, 1:200 @A3
Drawing No.	80500902-04-0853-C925
Rev	B

DO NOT SCALE - IF IN DOUBT, ASK

200 mm

150

100

50

20

10

ORIGINAL SIZE A1

EAST SIDE
(TYPICAL ALL SHEETS)

WEST SIDE
(TYPICAL ALL SHEETS)

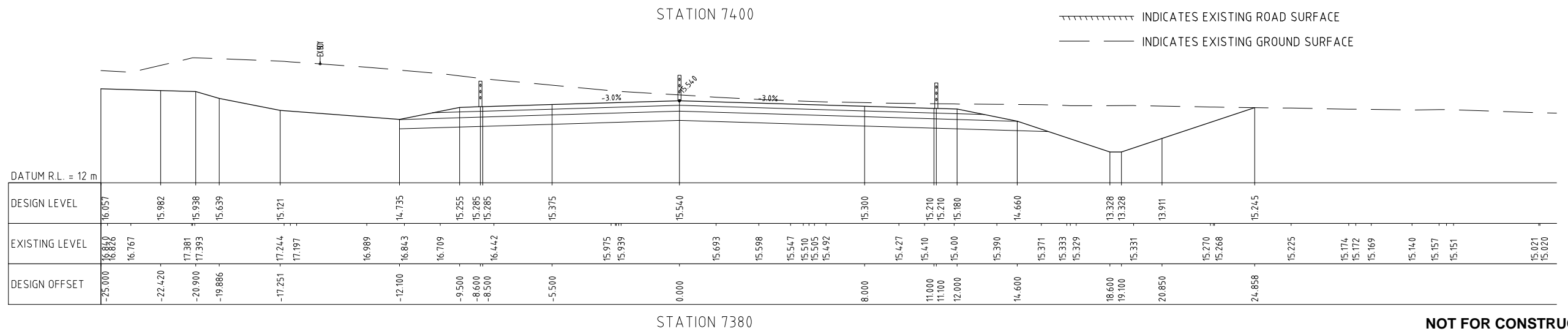
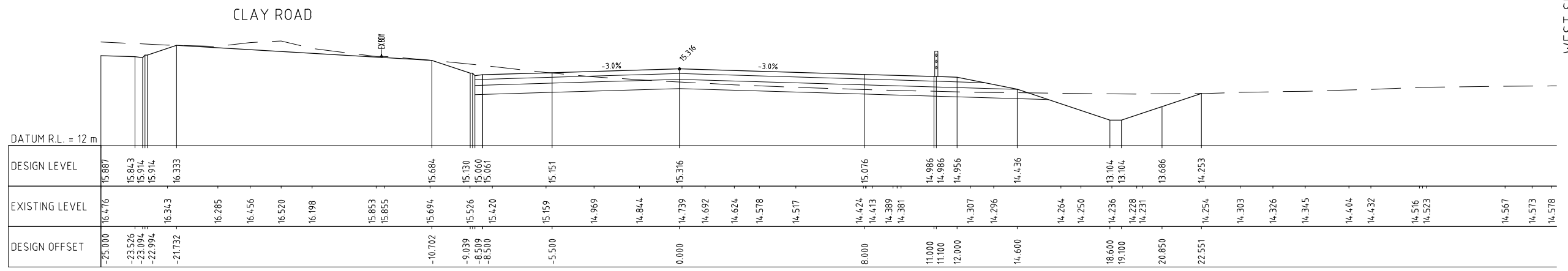
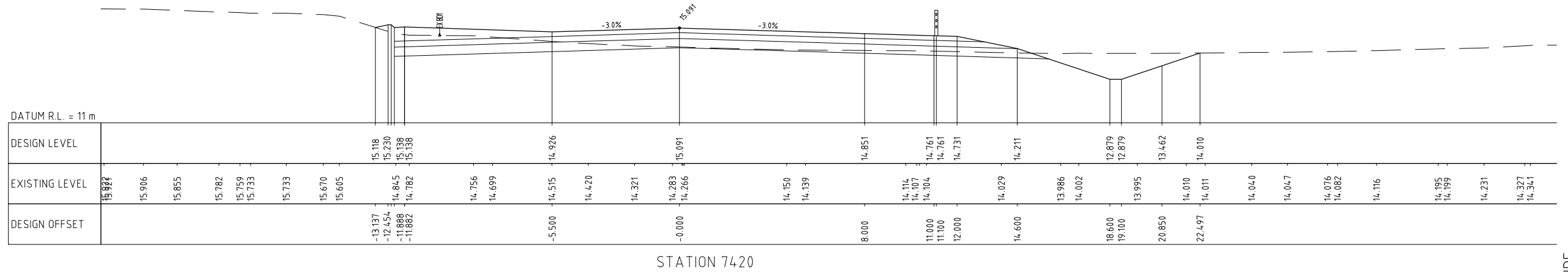
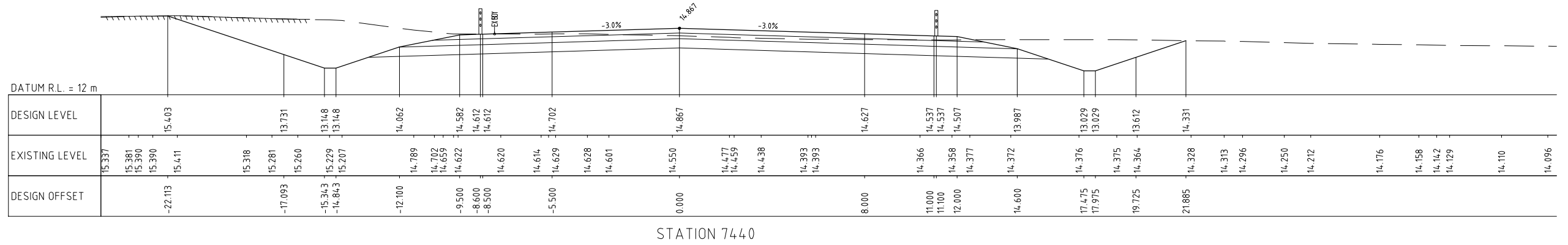

INDICATES EXISTING ROAD SURFACE
 INDICATES EXISTING GROUND SURFACE

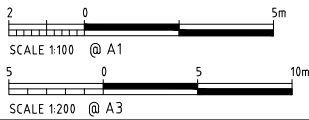

REV	DESCRIPTION	DATE	DRN	CHK	APP
B	ISSUE FOR CONSENT	11/15	PJC	JP	PP
A	FOR CONSULTATION	09/15	PJC	JP	JP
	REVISIONS		DRN	CHK	APP

SURVEYED	LIDAR & Aerial Photos	04/14
DESIGNED	Barbara Browne	06/14
DRAWN	Phillip Cook	06/14
CAD REVIEW		
DESIGN CHECK		
DESIGN REVIEW		
APPROVED		
PROF REGISTRATION:		



Client:
**WAITARERE BEACH ROAD
 CURVES PROJECT**
CROSS SECTIONS

Status Stamp	FOR CONSENT
Date Stamp	12/11/2015
Scales	1:100 @A1, 1:200 @A3
Drawing No.	80500902-04-0853-C930
Rev	B

NOT FOR CONSTRUCTION

DO NOT SCALE - IF IN DOUBT, ASK

200 mm

150

100

50

20

0

ORIGINAL SIZE A1

EAST SIDE
(TYPICAL ALL SHEETS)

WEST SIDE
(TYPICAL ALL SHEETS)

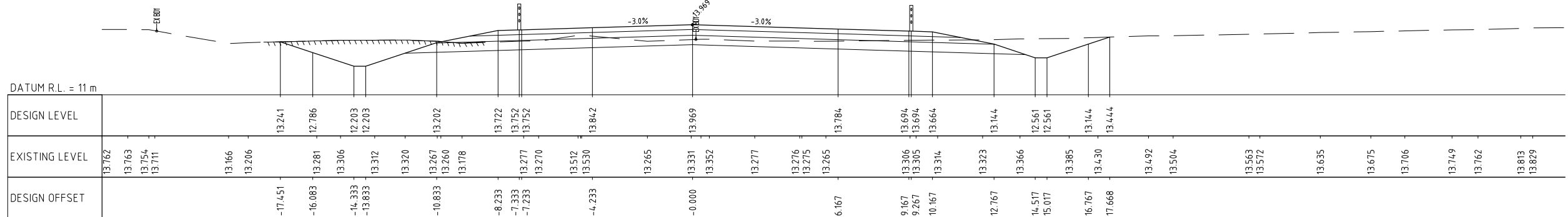

STATION 7520

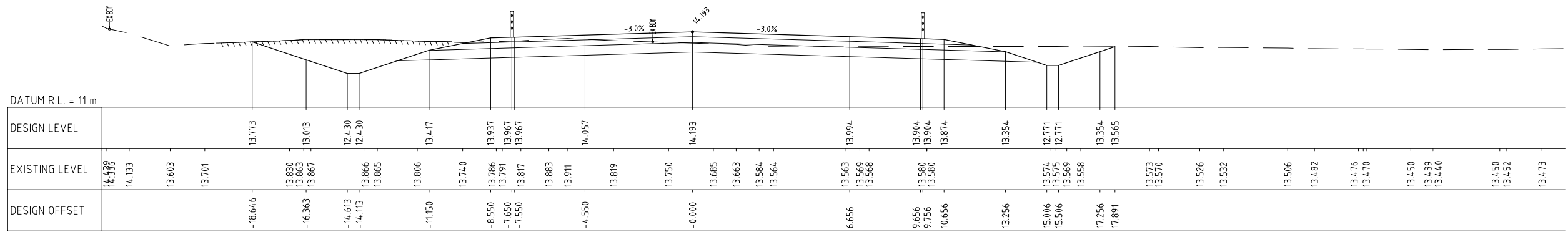

STATION 7500

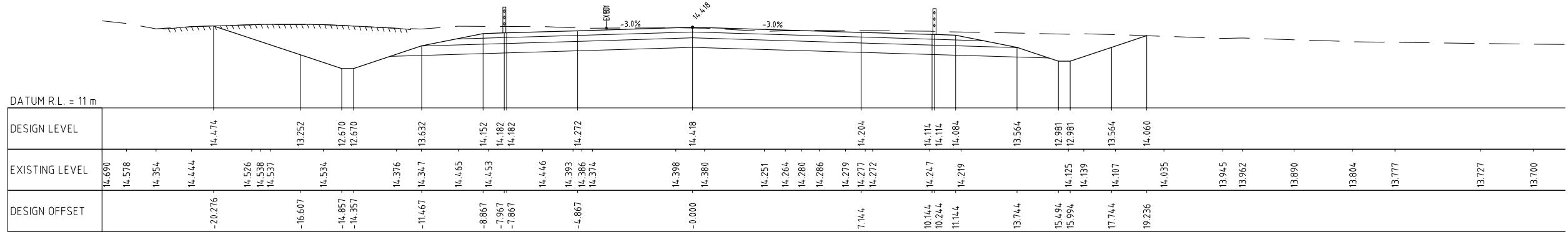

STATION 7480

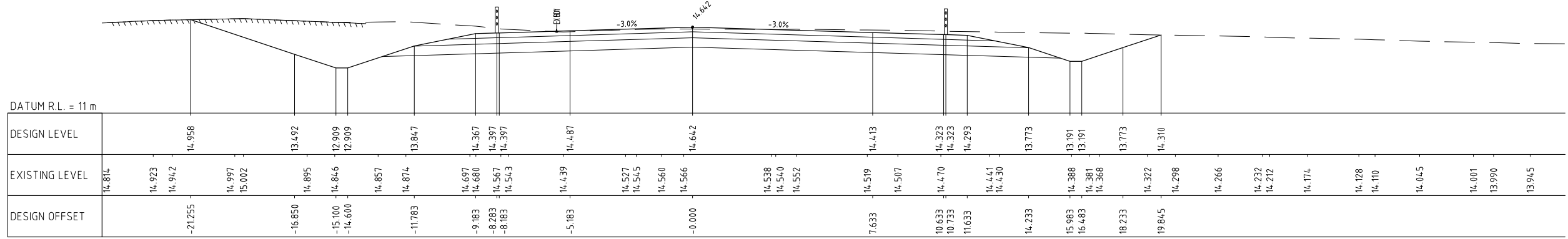

STATION 7460

INDICATES EXISTING ROAD SURFACE
 INDICATES EXISTING GROUND SURFACE

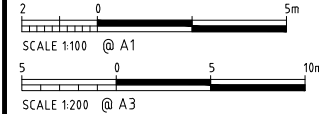

REV	DESCRIPTION	P/J	J/P	PP	11/15
B	ISSUE FOR CONSENT	PJC	JP	PP	11/15
A	FOR CONSULTATION	PJC	JP	PP	09/15
REV	REVISIONS	DRN	CHK	APP	DATE

SURVEYED	LIDAR & Aerial Photos	04/14
DESIGNED	Barbara Browne	06/14
DRAWN	Phillip Cook	06/14
CAD REVIEW		
DESIGN CHECK		
DESIGN REVIEW		
APPROVED		
PROF REGISTRATION		



Client: WAITARERE BEACH ROAD CURVES PROJECT
 CROSS SECTIONS

NOT FOR CONSTRUCTION	
Status Stamp	FOR CONSENT
Date Stamp	12/11/2015
Scales	1:100 @A1, 1:200 @A3
Drawing No.	80500902-04-0853-C931
Rev	B

DO NOT SCALE - IF IN DOUBT, ASK

200 mm

150

100

50

20

10

ORIGINAL SIZE A1

EAST SIDE
(TYPICAL ALL SHEETS)

WEST SIDE
(TYPICAL ALL SHEETS)

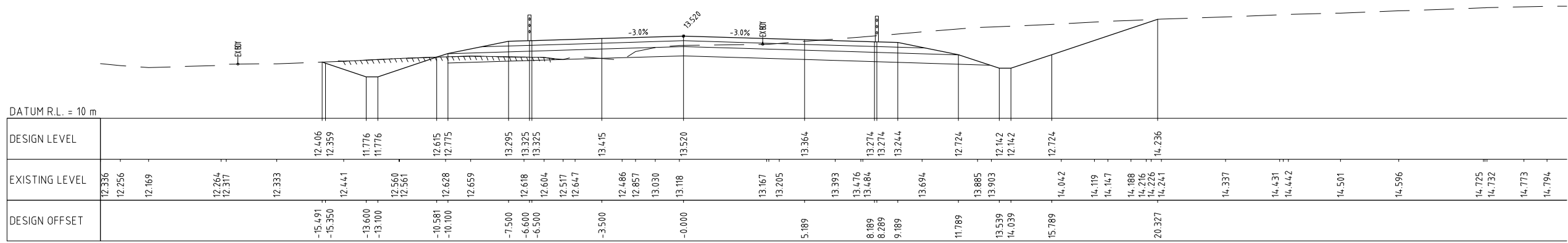
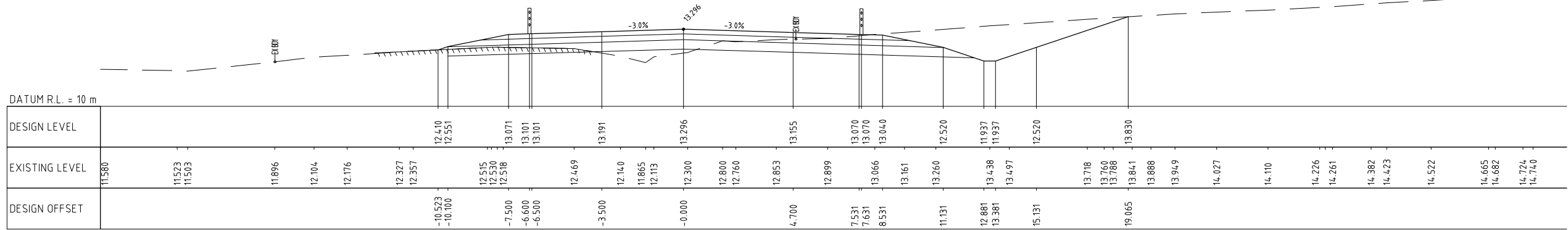
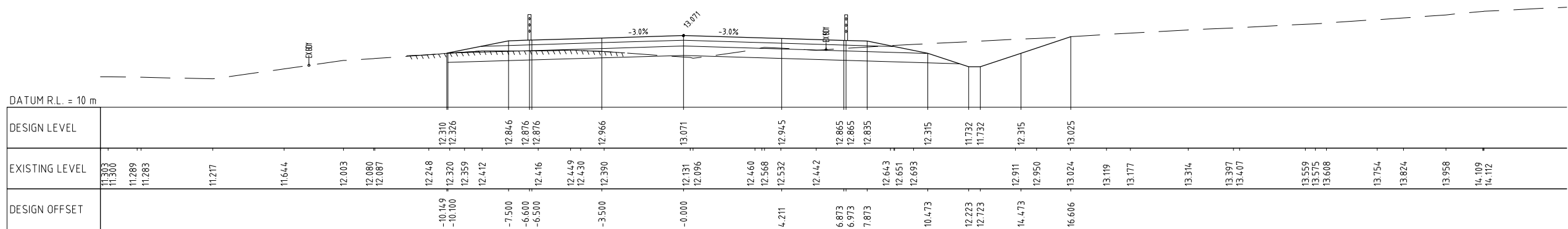

INDICATES EXISTING ROAD SURFACE
 INDICATES EXISTING GROUND SURFACE

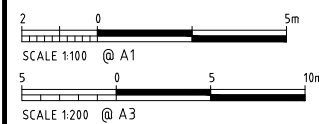
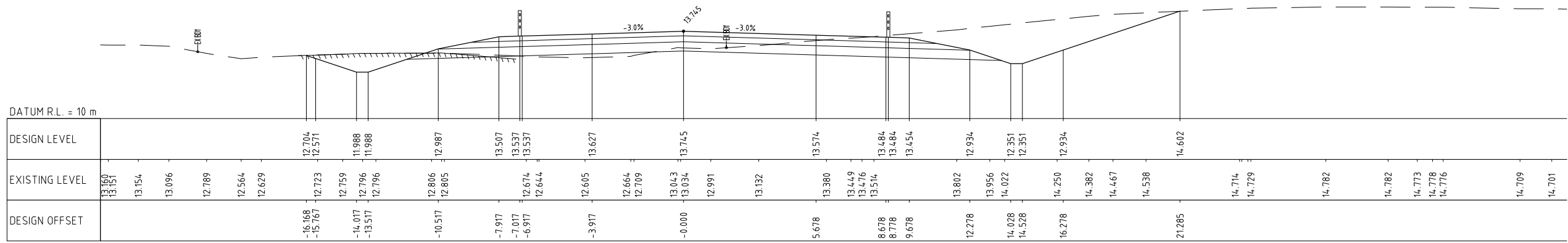

REV	DESCRIPTION	DATE	APP	CHK	DRN
B	ISSUE FOR CONSENT	11/15	PP	JP	PJC
A	FOR CONSULTATION	09/15	JP	JP	PJC
	REVISIONS				

SURVEYED	LIDAR & Aerial Photos	04/14
DESIGNED	Barbara Browne	06/14
DRAWN	Phillip Cook	06/14
CAD REVIEW		
DESIGN CHECK		
DESIGN REVIEW		
APPROVED		
PROF REGISTRATION:		



Client:
**WAITARERE BEACH ROAD
 CURVES PROJECT**

CROSS SECTIONS

Status Stamp	FOR CONSENT
Date Stamp	12/11/2015
Scales	1:100 @A1, 1:200 @A3
Drawing No.	80500902-04-0853-C932
Rev	B

DO NOT SCALE - IF IN DOUBT, ASK

200 mm
150
100
90
80
70
60
50
40
30
20
10
0

ORIGINAL SIZE A1

EAST SIDE
(TYPICAL ALL SHEETS)

WEST SIDE
(TYPICAL ALL SHEETS)

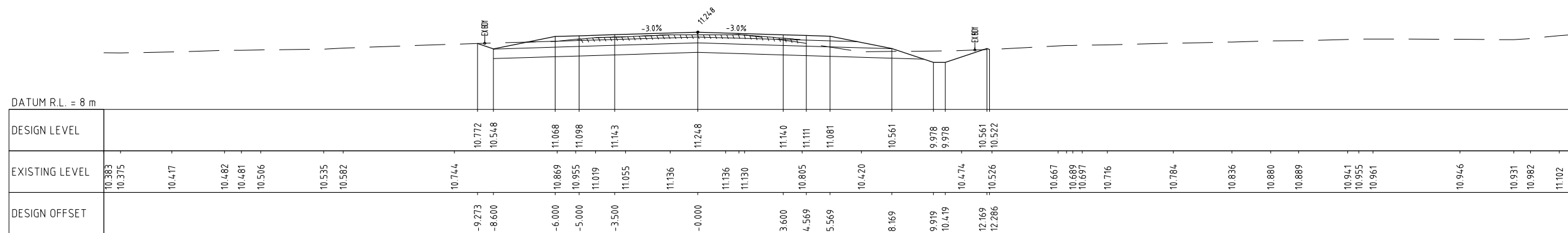

----- INDICATES EXISTING ROAD SURFACE
 - - - - - INDICATES EXISTING GROUND SURFACE

STATION 7800

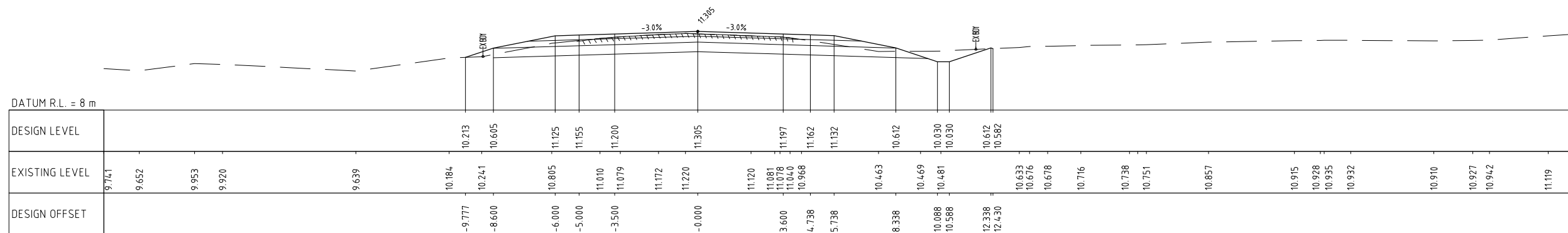

STATION 7780

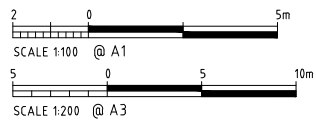

REV	DESCRIPTION	PJC	JP	PP	DATE
B	ISSUE FOR CONSENT				11/15
A	FOR CONSULTATION				09/15
	REVISIONS	DRN	CHK	APP	DATE

SURVEYED	LIDAR & Aerial Photos	04/14
DESIGNED	Barbara Browne	06/14
DRAWN	Phillip Cook	06/14
CAD REVIEW		
DESIGN CHECK		
DESIGN REVIEW		
APPROVED		
PROF REGISTRATION		

Client:

WAITARERE BEACH ROAD
 CURVES PROJECT

CROSS SECTIONS

Status Stamp	FOR CONSENT
Date Stamp	12/11/2015
Scales	1:100 @A1, 1:200 @A3
Drawing No.	80500902-04-0853-C935
Rev	B

NOT FOR CONSTRUCTION

DO NOT SCALE - IF IN DOUBT, ASK

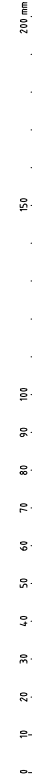

ORIGINAL SIZE A1

SOUTH SIDE
(TYPICAL ALL SHEETS)

----- INDICATES EXISTING ROAD SURFACE
- - - - - INDICATES EXISTING GROUND SURFACE

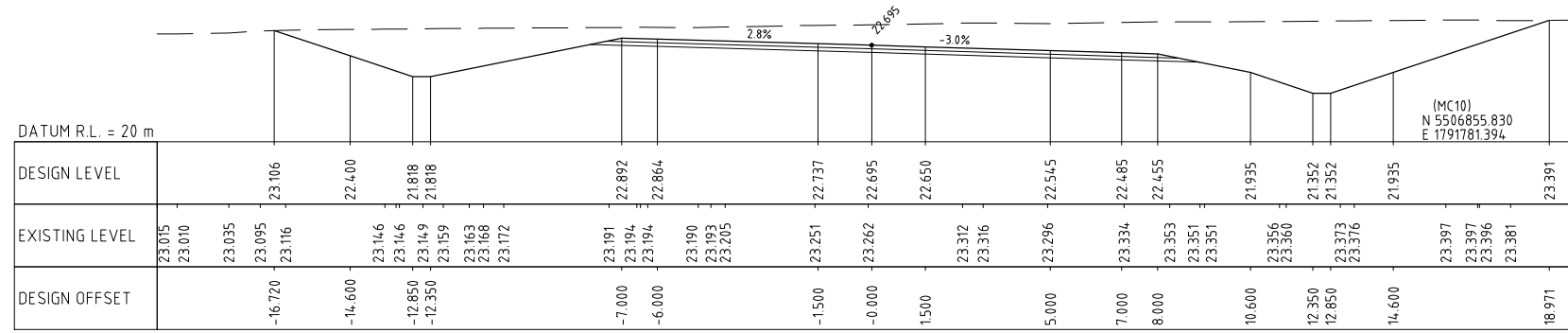

STATION 80

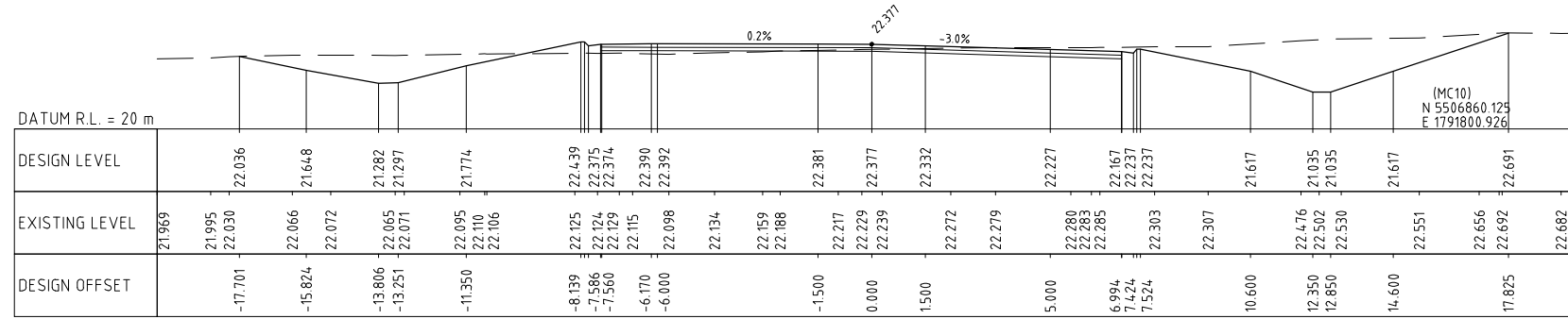

STATION 60

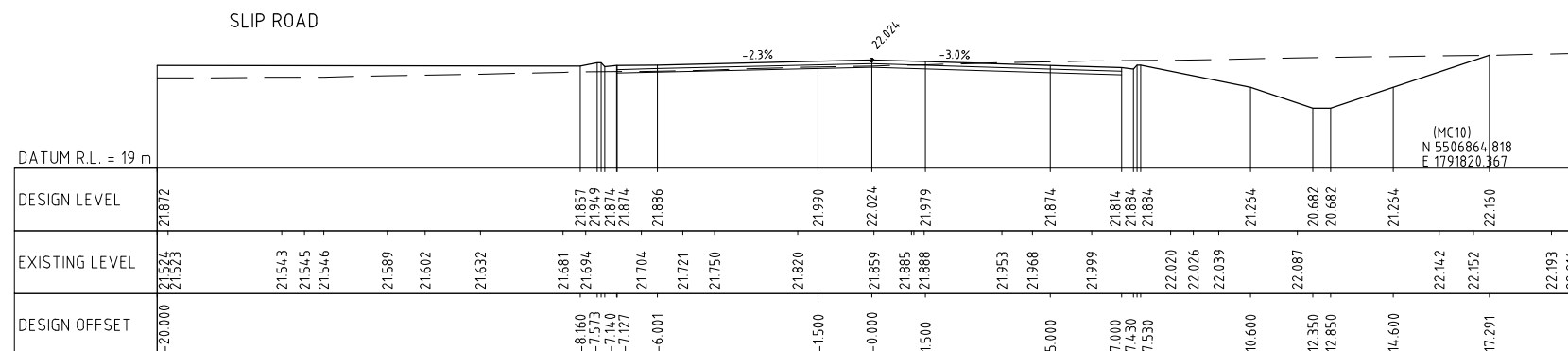

STATION 40

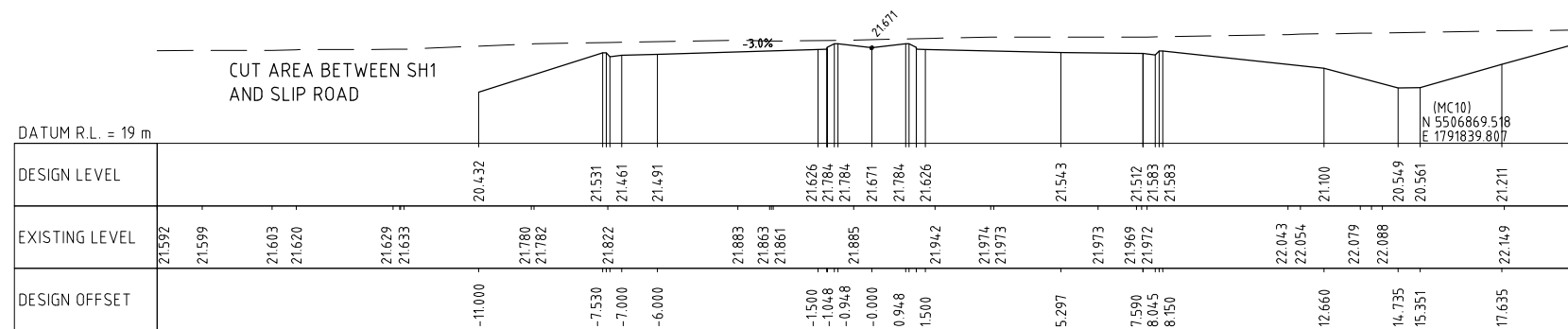

STATION 20

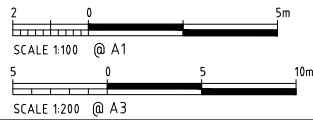

SCALE 1:100 @ A1					
SCALE 1:200 @ A3					
REV	DESCRIPTION	DATE	BY	CHK	APP
B	ISSUE FOR CONSENT	11/15	PJC	JP	PP
A	FOR CONSULTATION	09/15	PJC	JP	PP
REV	REVISIONS		DRN	CHK	APP

SURVEYED	LIDAR & Aerial Photos	04/14
DESIGNED	Barbara Browne	06/14
DRAWN	Phillip Cook	06/14
CAD REVIEW		
DESIGN CHECK		
DESIGN REVIEW		
APPROVED		
PROF REGISTRATION:		



WAITARERE BEACH ROAD
CURVES PROJECT

CROSS SECTIONS, MC10
WAITARERE BEACH ROAD

NOT FOR CONSTRUCTION

Status Stamp	FOR CONSENT
Date Stamp	12/11/2015
Scales	1:100 @A1, 1:200 @A3
Drawing No.	80500902-04-0853-C94.0
Rev	B

NORTH SIDE
(TYPICAL ALL SHEETS)

----- INDICATES EXISTING ROAD SURFACE
 - - - - - INDICATES EXISTING GROUND SURFACE

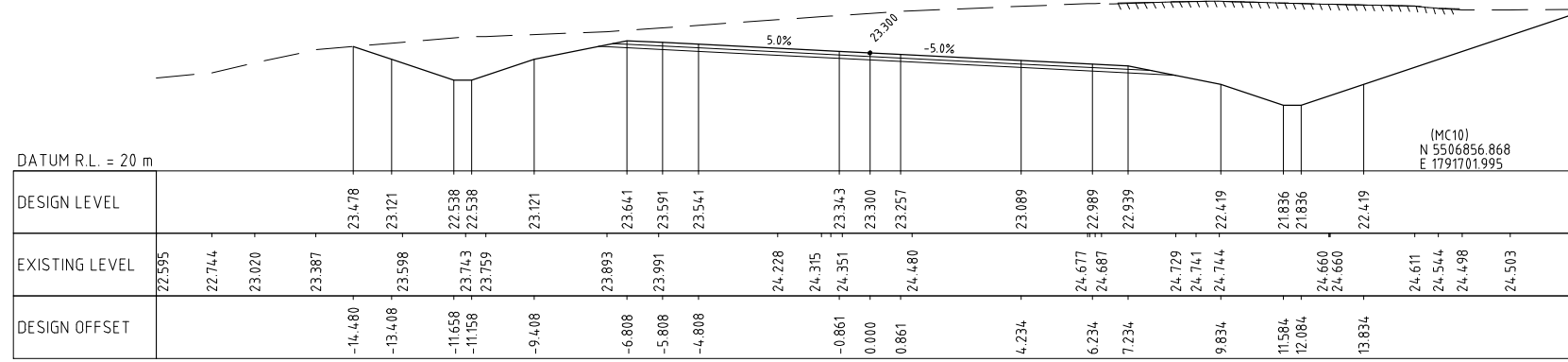

STATION 160

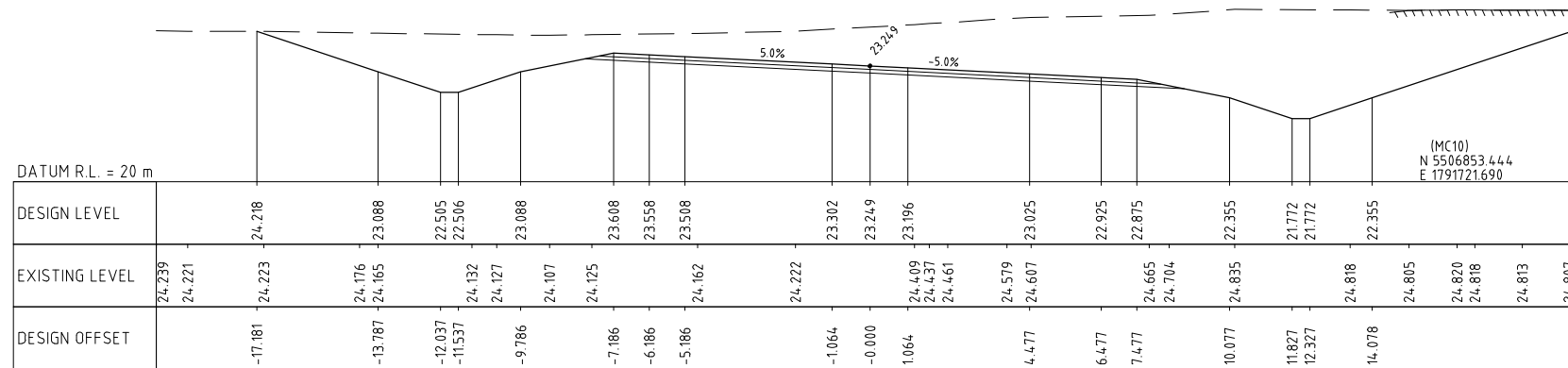

STATION 140

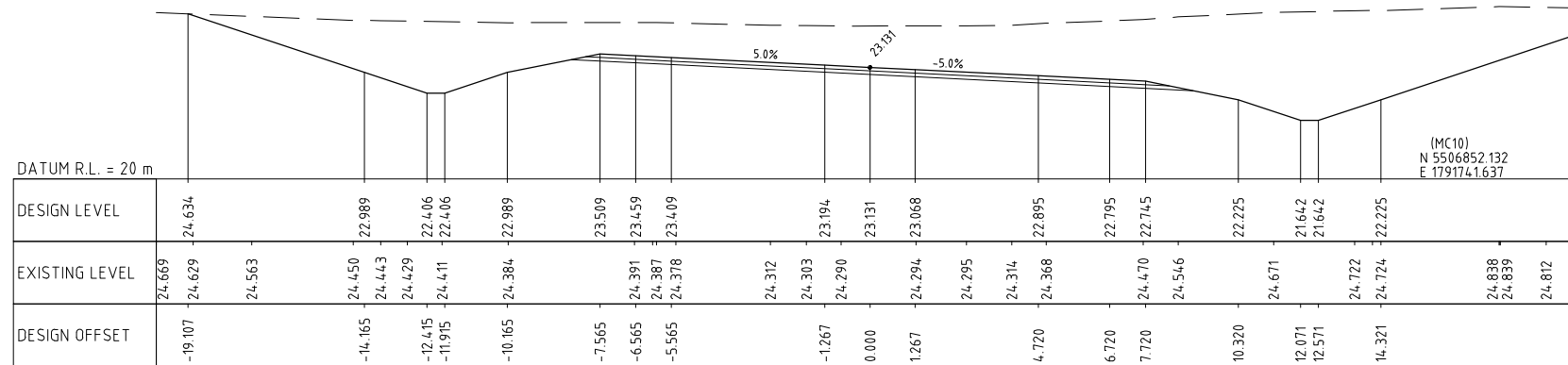

STATION 120

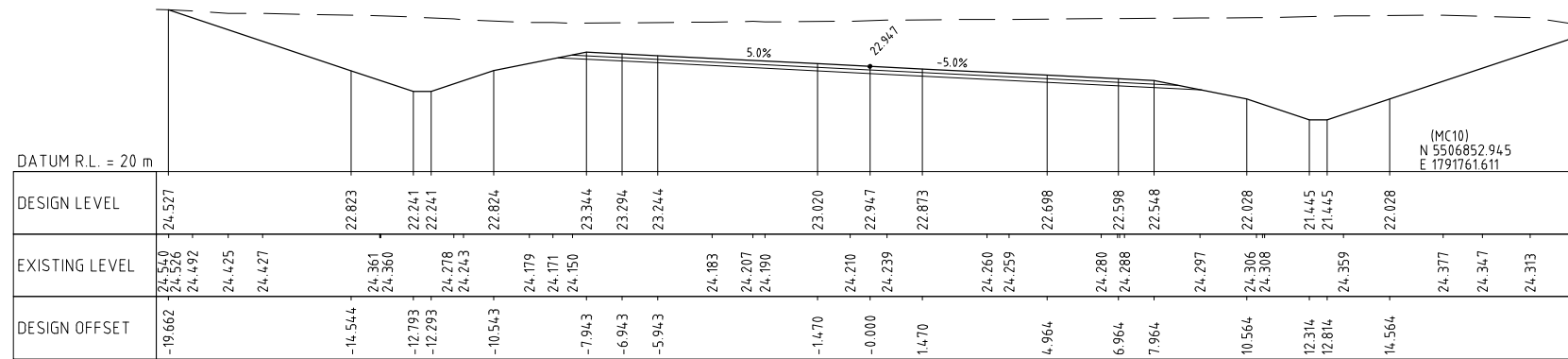

STATION 100

DO NOT SCALE - IF IN DOUBT, ASK

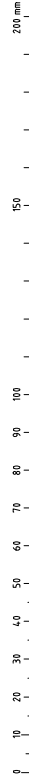

SOUTH SIDE
(TYPICAL ALL SHEETS)

ORIGINAL SIZE A1

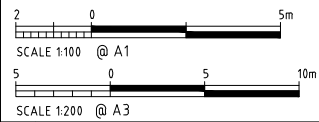

NORTH SIDE
(TYPICAL ALL SHEETS)

REV	DESCRIPTION	PJC	JP	PP	11/15
B	ISSUE FOR CONSENT	PJC	JP	PP	11/15
A	FOR CONSULTATION	PJC	JP	PP	09/15
REV	REVISIONS	DRN	CHK	APP	DATE

SURVEYED	LIDAR & Aerial Photos	04/14
DESIGNED	Barbara Browne	06/14
DRAWN	Phillip Cook	06/14
CAD REVIEW		
DESIGN CHECK		
DESIGN REVIEW		
APPROVED		
PROF REGISTRATION		



WAITARERE BEACH ROAD
CURVES PROJECT

CROSS SECTIONS, MC10
WAITARERE BEACH ROAD

NOT FOR CONSTRUCTION

Status Stamp	FOR CONSENT
Date Stamp	12/11/2015
Scales	1:100 @A1, 1:200 @A3
Drawing No.	80500902-04-0853-C941
Rev	B

DO NOT SCALE - IF IN DOUBT, ASK

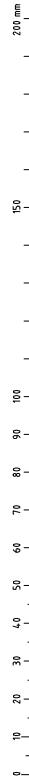

ORIGINAL SIZE A1

SOUTH SIDE
(TYPICAL ALL SHEETS)

INDICATES EXISTING ROAD SURFACE
INDICATES EXISTING GROUND SURFACE

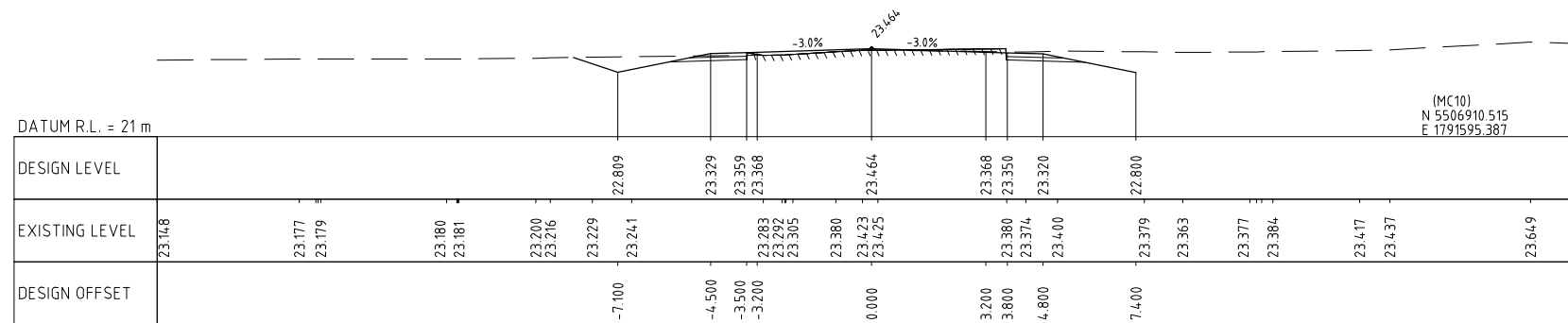

STATION 280

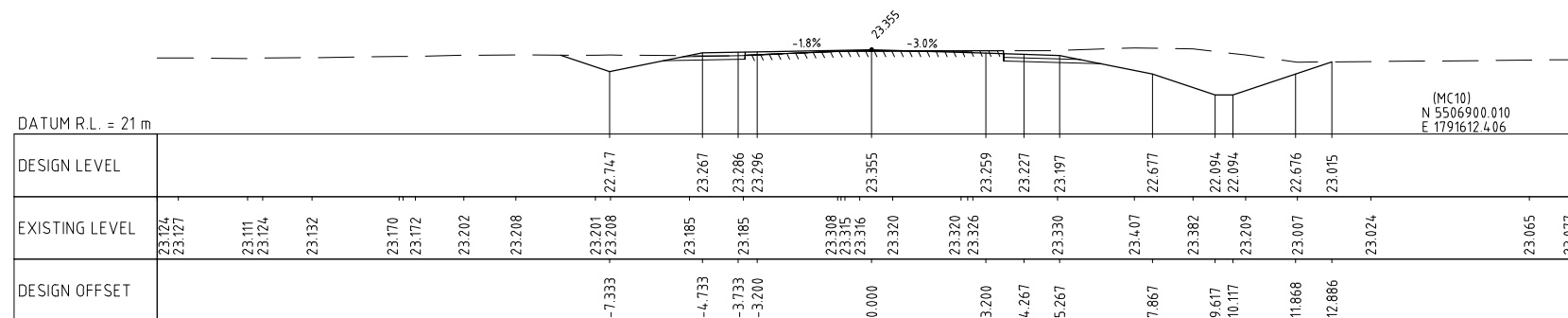

STATION 260

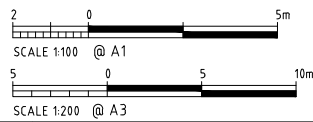

REV	DESCRIPTION	DATE	APP	CHK	DRN
B	ISSUE FOR CONSENT	11/15	PP	JP	PJC
A	FOR CONSULTATION	09/15	JP	JP	PJC
	REVISIONS				

SURVEYED	LIDAR & Aerial Photos	04/14
DESIGNED	Barbara Browne	06/14
DRAWN	Phillip Cook	06/14
CAD REVIEW		
DESIGN CHECK		
DESIGN REVIEW		
APPROVED		
PROF REGISTRATION:		



WAITARERE BEACH ROAD
CURVES PROJECT

CROSS SECTIONS, MC10
WAITARERE BEACH ROAD

NOT FOR CONSTRUCTION

Status Stamp	FOR CONSENT
Date Stamp	12/11/2015
Scales	1:100 @A1, 1:200 @A3
Drawing No.	80500902-04-0853-C943
Rev	B

NORTH SIDE
(TYPICAL ALL SHEETS)

DO NOT SCALE - IF IN DOUBT, ASK

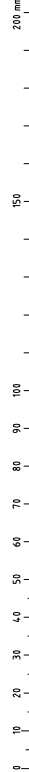

ORIGINAL SIZE **A1**

WEST SIDE

EAST SIDE

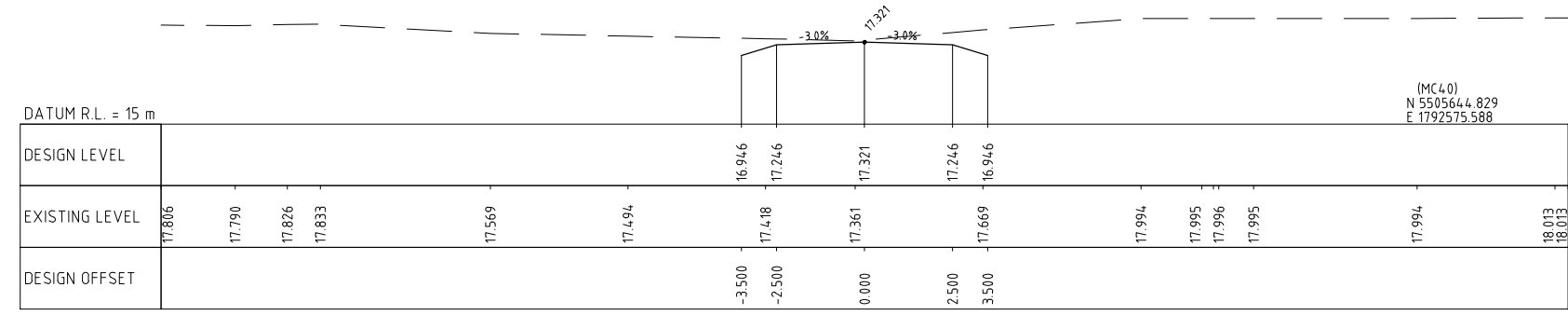

STATION 50

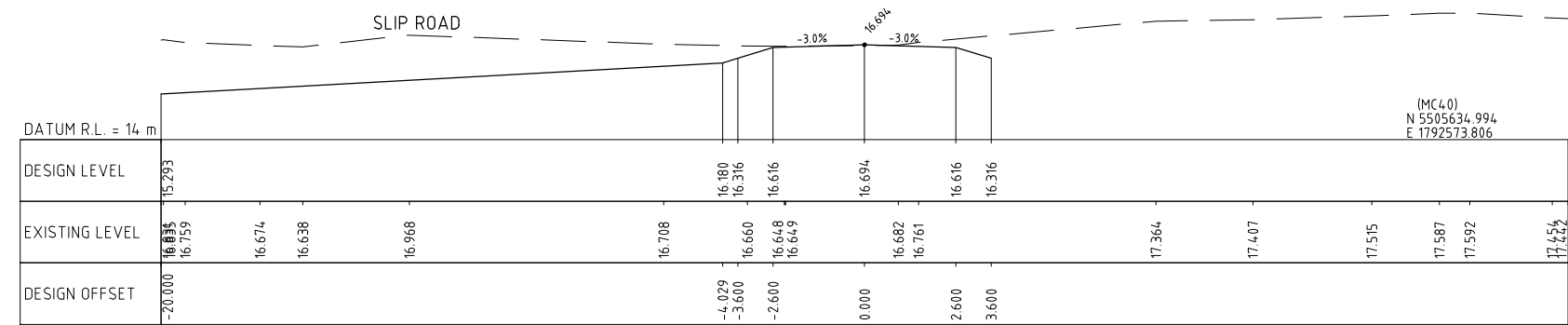

STATION 40

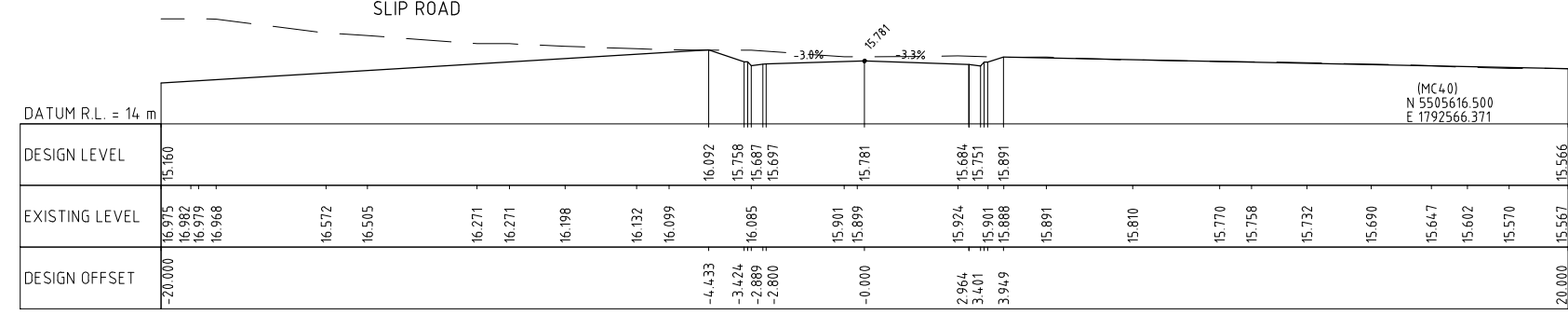

STATION 20

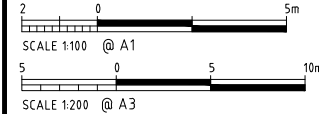

B	ISSUE FOR CONSENT		PJC	JP	PP	11/15			
A	FOR CONSULTATION		PJC	JP	JP	09/15			
REV			DRN	CHK	APP	DATE			

SURVEYED	LIDAR & Aerial Photos	04/14
DESIGNED	Barbara Browne	06/14
DRAWN	Phillip Cook	07/14
CAD REVIEW		
DESIGN CHECK		
DESIGN REVIEW		
APPROVED		
PROF REGISTRATION		



WAITARERE BEACH ROAD
CURVES PROJECT

CROSS SECTIONS, MC40
CLAY ROAD

NOT FOR CONSTRUCTION

Status Stamp	FOR CONSENT
Date Stamp	18.11.15
Scales	1:100 @A1, 1:200 @A3
Drawing No.	80500902-04-0853-C945
Rev	B

DO NOT SCALE - IF IN DOUBT, ASK

200 mm
150
100
90
80
70
60
50
40
30
20
10
0

ORIGINAL SIZE A1

EAST SIDE
(TYPICAL ALL SHEETS)

INDICATES EXISTING ROAD SURFACE
INDICATES EXISTING GROUND SURFACE

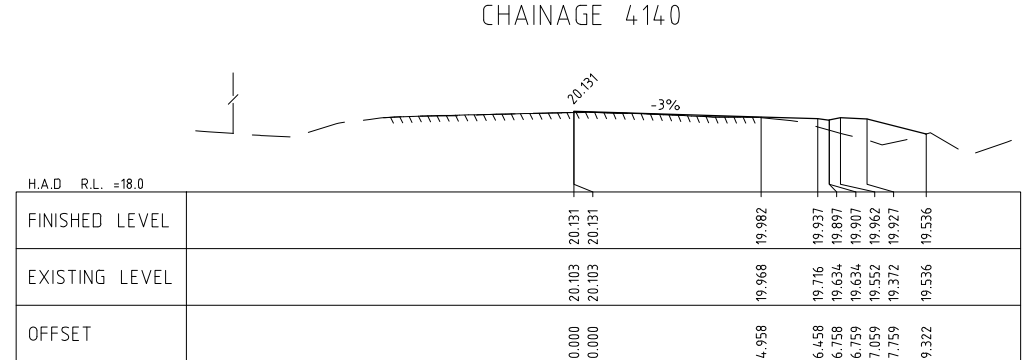
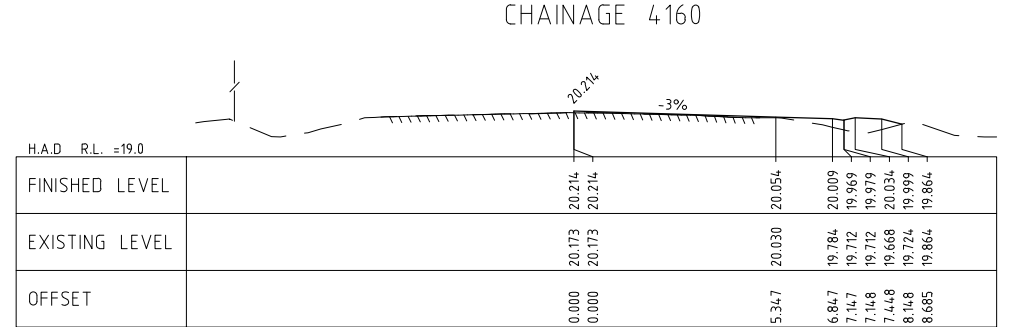
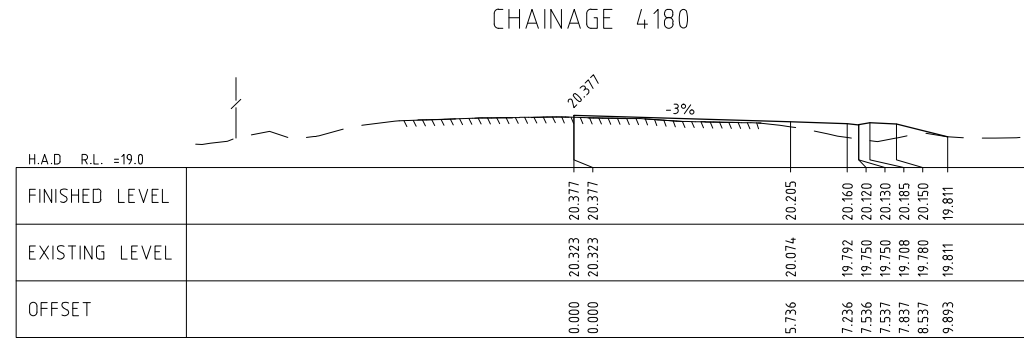
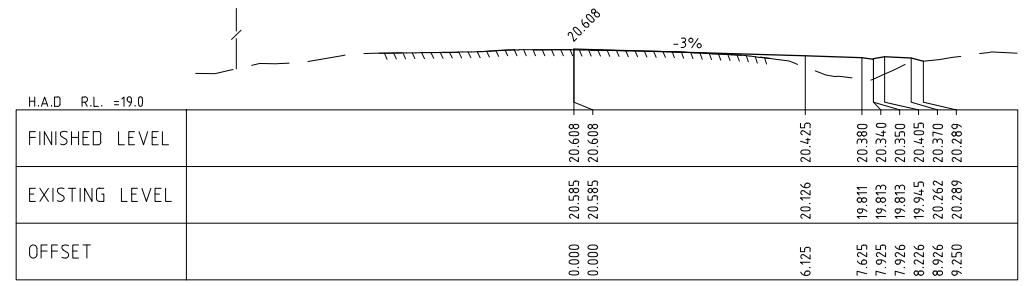
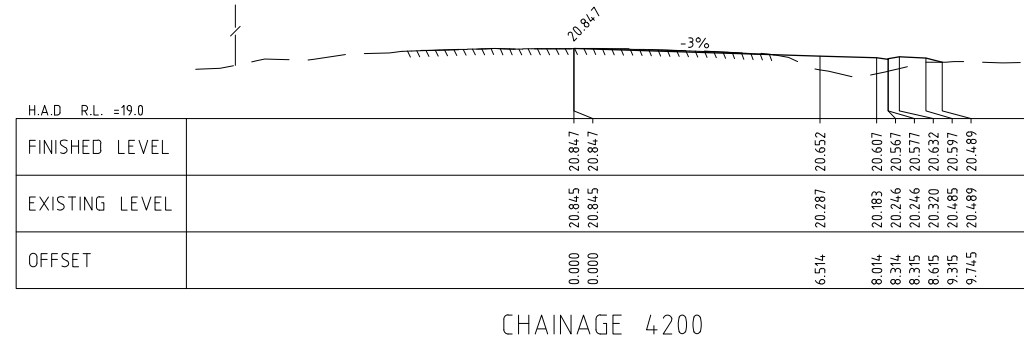
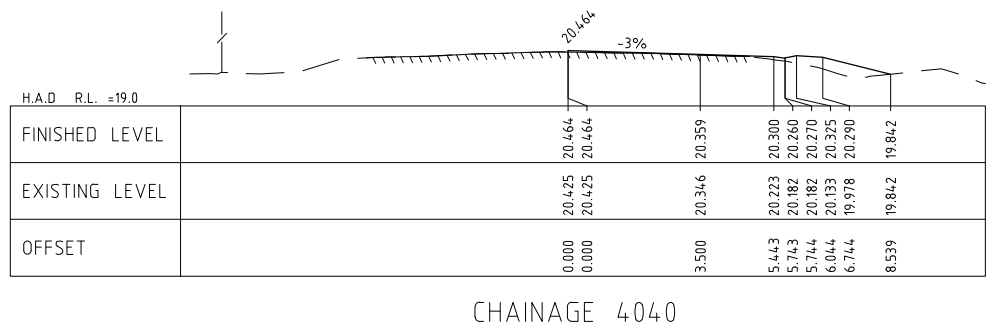
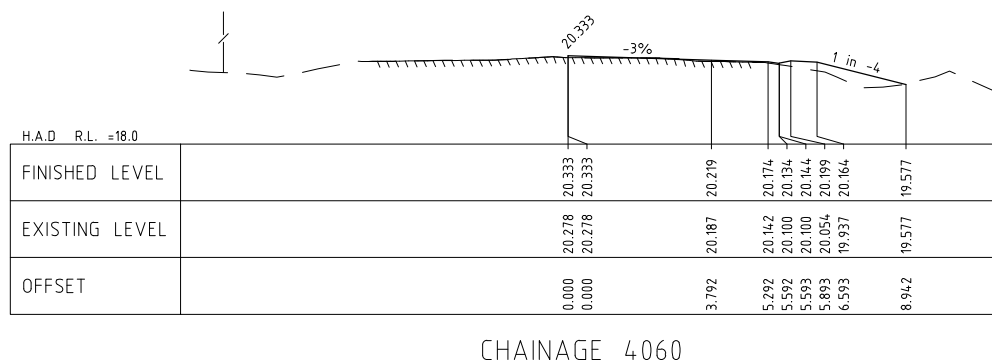
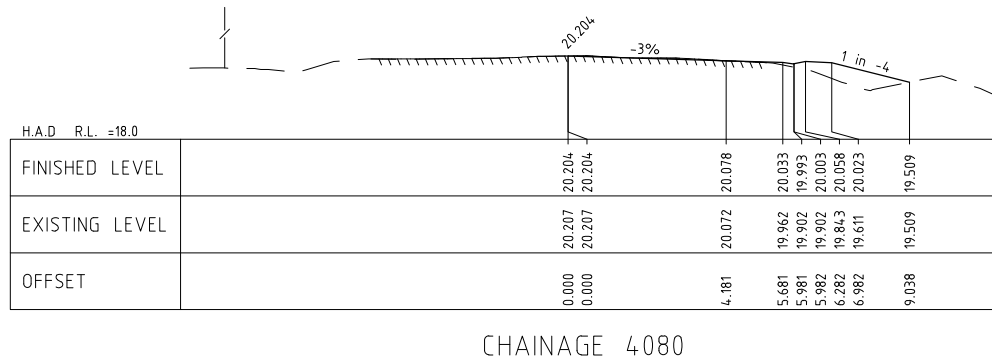
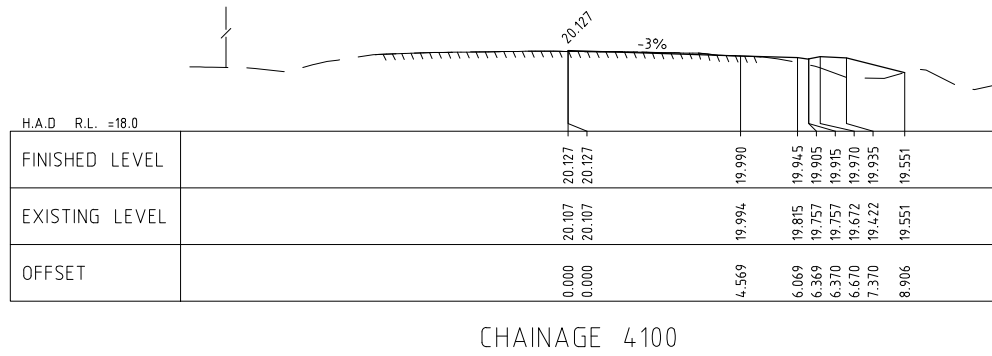

WEST SIDE
(TYPICAL ALL SHEETS)

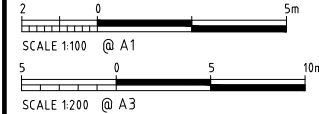

REV	DESCRIPTION	PJC	JP	PP	DATE
B	ISSUE FOR CONSENT				11/15
A	FOR CONSULTATION				09/15
REV	REVISIONS	DRN	CHK	APP	DATE

SURVEYED		
DESIGNED	Graeme Corin	07/15
DRAWN	Phillip Cook	09/15
CAD REVIEW		
DESIGN CHECK		
DESIGN REVIEW		
APPROVED		
PROF REGISTRATION:		



Client:
WAITARERE BEACH ROAD
CURVES PROJECT
CROSS SECTIONS, MCS0
POROUTAWHAO SCHOOL RIGHT TURN BAY

Status Stamp	FOR CONSENT
Date Stamp	12/11/2015
Scales	1:100 @A1, 1:200 @A3
Drawing No.	80500902-04-0853-C961
Rev	B

ORIGINAL SIZE A1

EAST SIDE
(TYPICAL ALL SHEETS)

WEST SIDE
(TYPICAL ALL SHEETS)

INDICATES EXISTING ROAD SURFACE
 INDICATES EXISTING GROUND SURFACE

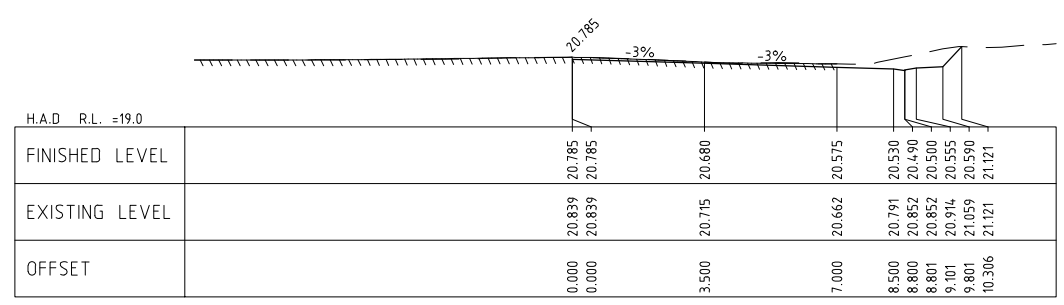

CHAINAGE 4280

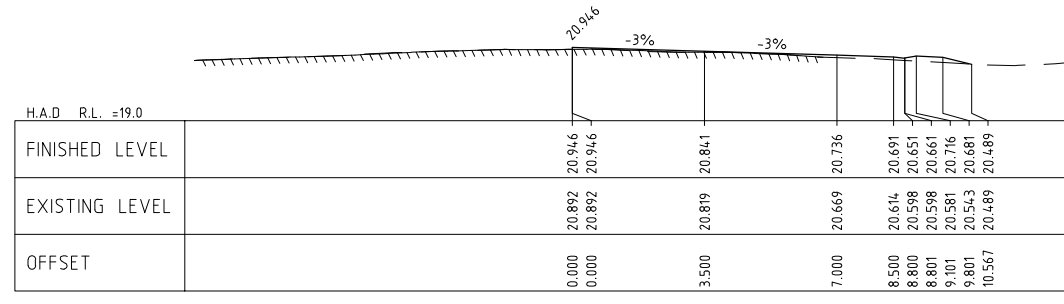

CHAINAGE 4260

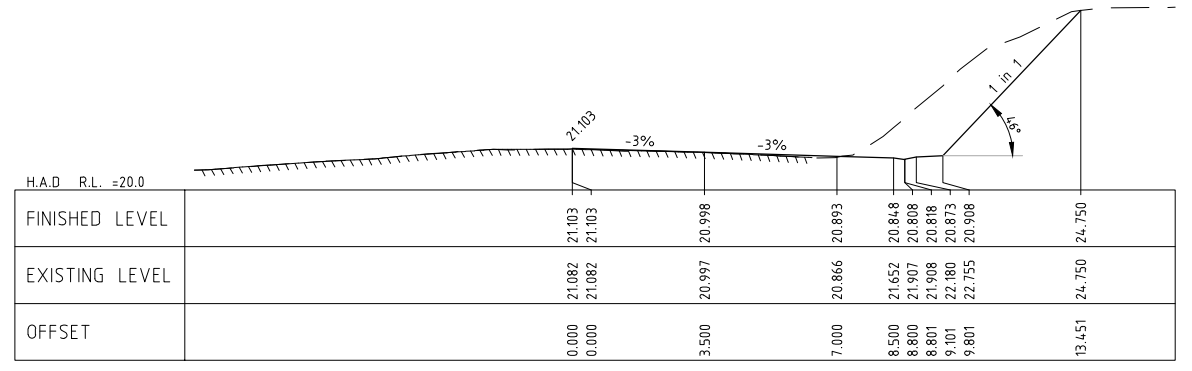

CHAINAGE 4240

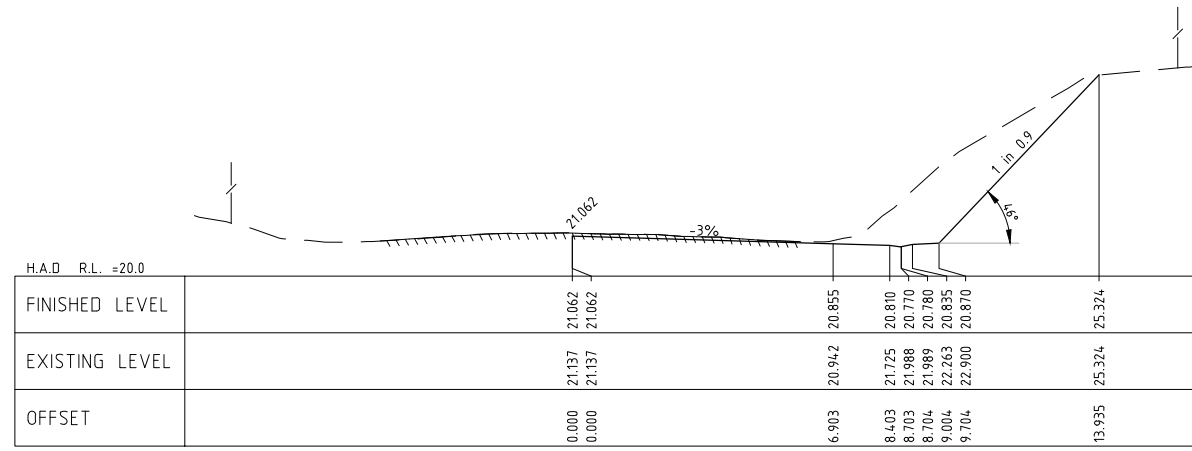

CHAINAGE 4220

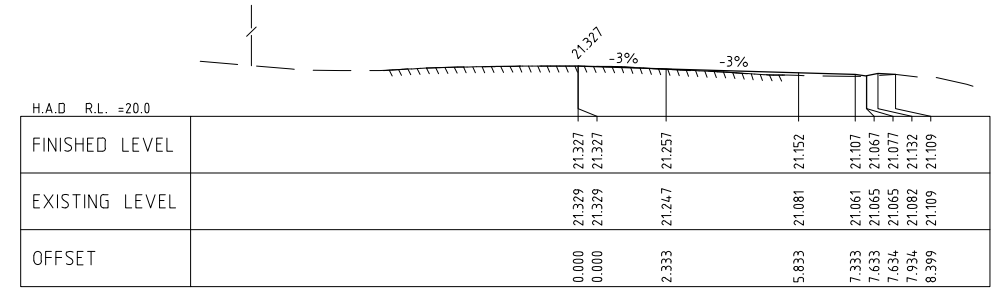

CHAINAGE 4380

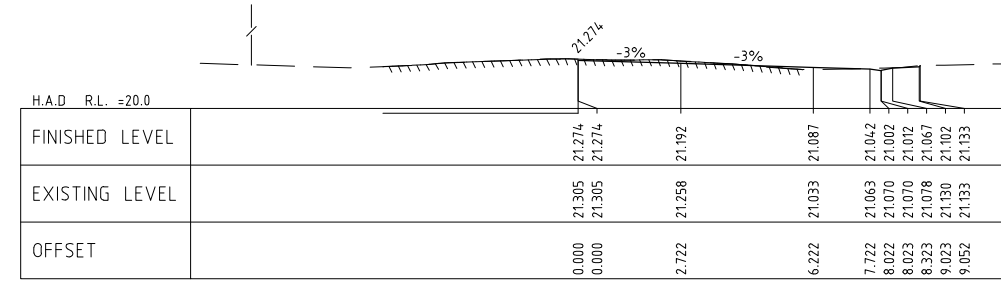

CHAINAGE 4360

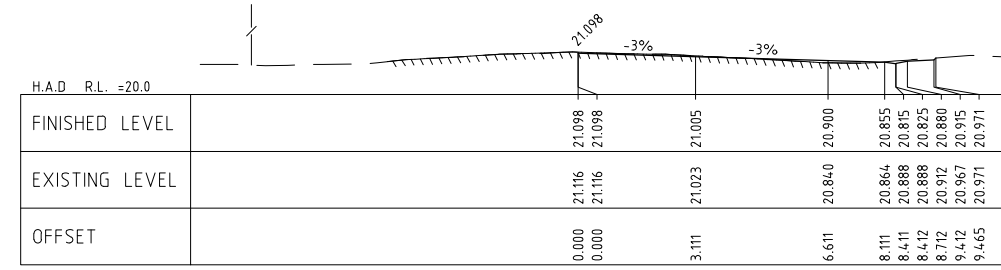

CHAINAGE 4340

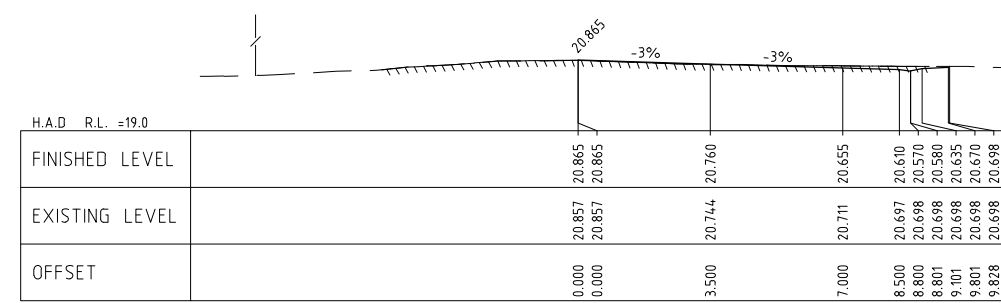

CHAINAGE 4320

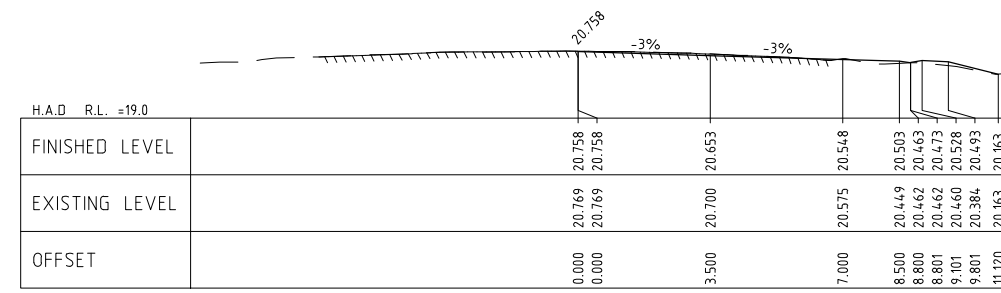

CHAINAGE 4300

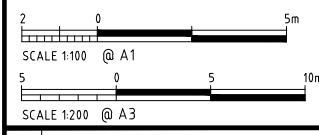

REV	DESCRIPTION	PJC	JP	PP	DATE
B	ISSUE FOR CONSENT				11/15
A	FOR CONSULTATION				09/15
REV	REVISIONS	DRN	CHK	APP	DATE

SURVEYED		
DESIGNED	Graeme Corin	07/15
DRAWN	Phillip Cook	09/15
CAD REVIEW		
DESIGN CHECK		
DESIGN REVIEW		
APPROVED		
PROF REGISTRATION:		



WAITARERE BEACH ROAD
 CURVES PROJECT
 CROSS SECTIONS, MCS0
 POROUTAWHAO SCHOOL RIGHT TURN BAY

Status Stamp	FOR CONSENT
Date Stamp	12/11/2015
Scales	1:100 @A1, 1:200 @A3
Drawing No.	80500902-04-0853-C962
Rev	B

NOT FOR CONSTRUCTION

DO NOT SCALE - IF IN DOUBT, ASK

200 mm
150
100
90
80
70
60
50
40
30
20
10
0

ORIGINAL SIZE A1

EAST SIDE
(TYPICAL ALL SHEETS)

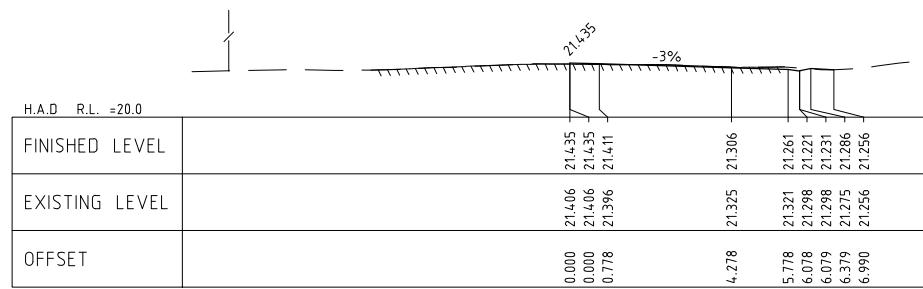

CHAINAGE 4460

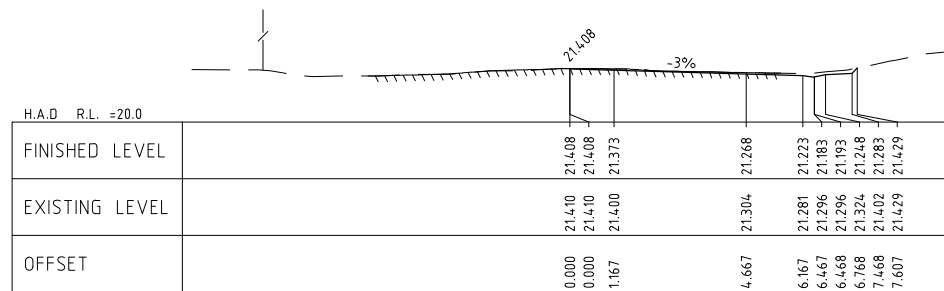

CHAINAGE 4440

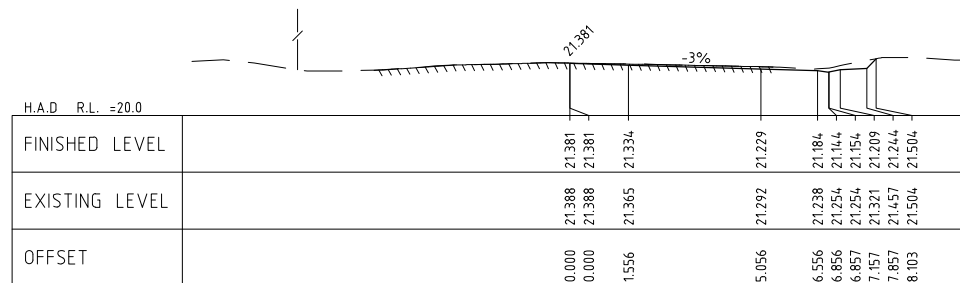

CHAINAGE 4420

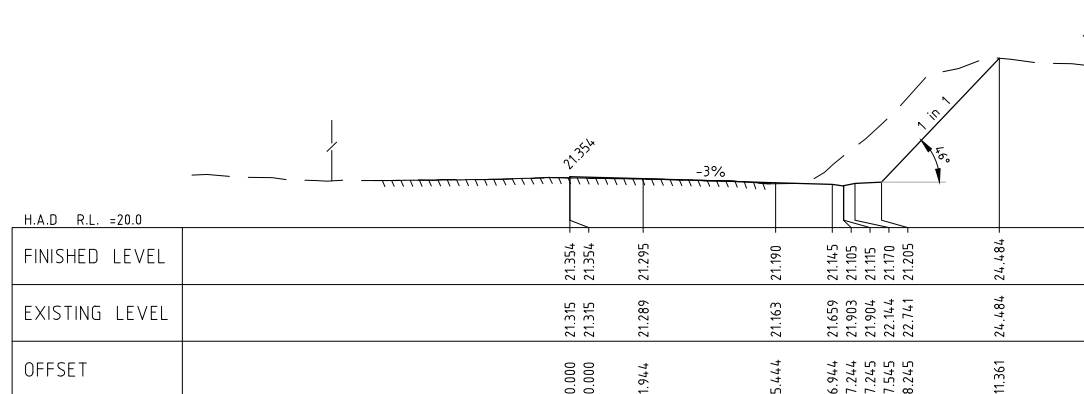

CHAINAGE 4400

INDICATES EXISTING ROAD SURFACE
INDICATES EXISTING GROUND SURFACE

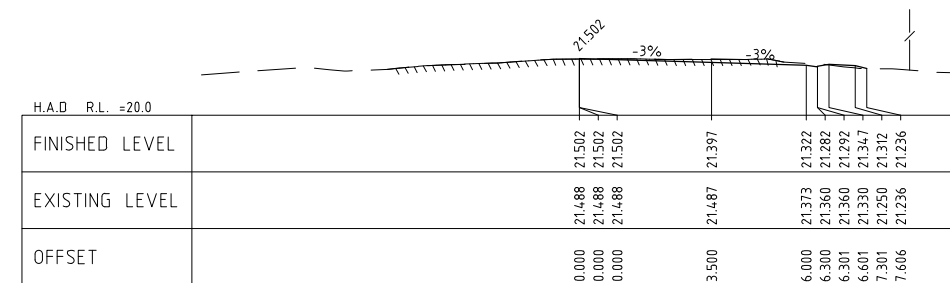

CHAINAGE 4510

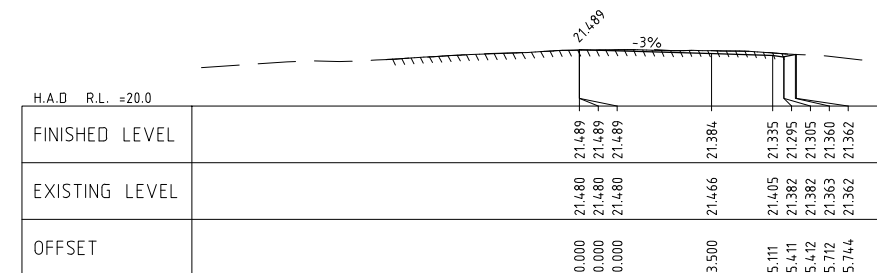

CHAINAGE 4500

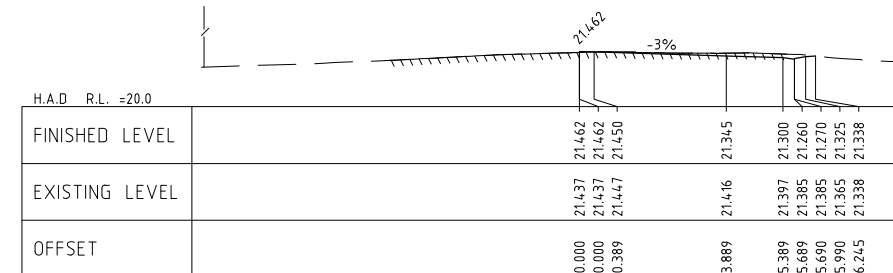

CHAINAGE 4480

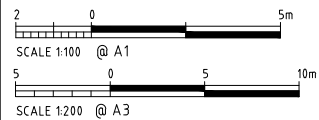

REV	DESCRIPTION	PJC	JP	PP	11/15
B	ISSUE FOR CONSENT	PJC	JP	PP	11/15
A	FOR CONSULTATION	PJC	JP	PP	09/15
REV	REVISIONS	DRN	CHK	APP	DATE

SURVEYED	DESIGNED	DRAWN	CAD REVIEW	DESIGN CHECK	DESIGN REVIEW	APPROVED	PROF REGISTRATION
	Graeme Corin	Phillip Cook					



Client:
WAITARERE BEACH ROAD
CURVES PROJECT
CROSS SECTIONS, MCS0
POROUTAWHAO SCHOOL RIGHT TURN BAY

Status Stamp	Date Stamp	Scales	Drawing No.	Rev
FOR CONSENT	12/11/2015	1:100 @A1, 1:200 @A3	80500902-04-0853-C963	B

NOT FOR CONSTRUCTION