

Traffic control devices manual

Part 9

Level crossings



Traffic control devices manual

Part 9 Level crossings

© NZ Transport Agency

www.nzta.govt.nz

Second edition, amendment 1

Effective from December 2012

ISBN 978-0-478-40712-9 (online)

Contents

Preface		iv
Record of amendments		vi
1.0	Introduction	1
	1.1 Purpose	1
	1.2 Level crossings	1
	1.3 Scope of document	2
	1.4 Definitions	2
	1.5 Engineering judgement	2
	1.6 Value for money	3
	1.7 All practical steps	3
2.0	Responsibilities for level crossings	4
	2.1 General principles and powers	4
	2.2 What is a level crossing?	4
	2.3 Legal status of level crossings	5
	2.4 Types of level crossings	7
	2.5 New level crossings	9
	2.6 Closure of level crossings	9
	2.7 Out-of-service railway lines	10
	2.8 Reopening of railway lines	11
	2.9 Trespass	11
3.0	Risk assessment and ALCAM	12
	3.1 Introduction	12
	3.2 ALCAM description	12
	3.3 Assessment of level crossings	13
	3.4 Other considerations	14
4.0	Traffic signs	15
	4.1 Introduction	15
	4.2 General specifications	15
	4.3 Signs used at level crossings	16
	4.4 Signs used in advance of level crossings	27

5.0	Road marking	38
5.1	Standards	38
5.2	Responsibilities	38
5.3	Requirements	38
6.0	Control devices	43
6.1	Introduction	43
6.2	Types of controls	43
6.3	Railway-activated control devices	44
6.4	Traffic signal integration with level crossing	46
6.5	Locomotive-mounted warning devices	46
6.6	Rail vehicles yielding to road traffic	46
7.0	Road geometry, surfacing and lighting	47
7.1	Introduction	47
7.2	Responsibility	47
7.3	Standard construction requirements for level crossings	48
7.4	Seal requirements	48
7.5	Alignment	49
7.6	Traffic islands	49
7.7	Level crossing in close proximity to an intersection	49
7.8	Level crossing in close proximity to a driveway	50
7.9	Lighting	51
8.0	Requirements for pedestrian and cycle level crossings	52
8.1	Introduction	52
8.2	Pedestrian level crossings	52
8.3	Cycle facilities	54
8.4	Footway and cycleway construction	54
8.5	Pedestrian mazes	54
8.6	Active protection	55
9.0	Requirements for specific road vehicles	56
9.1	Buses and dangerous goods vehicles at level crossings	56
9.2	Overweight and over-dimension road loads	56

10.0	Requirements for private level crossings	58
10.1	Introduction	58
10.2	Private property access level crossings	58
11.0	Requirements for rail operations level crossings	60
11.1	Introduction	60
11.2	Rail access level crossings	60
11.3	Public access level crossings	60
12.0	Requirements for tramway level crossings	61
12.1	Introduction	61
12.2	Tramway level crossings	61
12.3	Tramways as special vehicle lanes	62
	Appendix A - Standard sign and marking layouts	63
	Appendix B - Sight distances at level crossings	81
	Appendix C - Working on or near level crossings	90
	Appendix D - Australian Level Crossing Assessment Model (ALCAM)	92
	Appendix E - Installation and maintenance responsibilities around level crossings	121

Preface

Introduction

The NZ Transport Agency's *Traffic control devices manual* (TCD manual) provides guidance on industry good practice including, where necessary, practice mandated by law. The structure of the TCD manual comprises 10 parts as shown in [Table A: Planned structure of the TCD manual](#).

Each part has been developed under the guidance of a representative working group of practitioners experienced in, and having specific knowledge about, the subject. Interested practitioners and affected organisations were given the opportunity to comment on drafts and their input has been incorporated appropriately in the final document.

The TCD manual will only be published electronically and will be available on the NZ Transport Agency's (NZTA) website.

Relationship with other documents

The TCD manual will support and reference:

- New Zealand legislation and, in particular Railways Act 2005, Public Works Act 1981, New Zealand Railways Corporation Act 1981, Land Transport Act 1998 and rules made pursuant to that Act, including the Land Transport (Road User Rule) Rule 2004, Land Transport Rule: Traffic Control Devices 2004 (Rule 54002) (TCD Rule) and Land Transport Rule: Setting of Speed Limits 2003.

Note: This manual is subordinate to legislation and any legal access agreements. Professional legal advice should be taken where appropriate

- the detailed descriptions of devices contained in the companion document *Traffic control devices specifications*
- general polices contained in Austroads guides (in particular, the guides to traffic management, traffic design and road safety) by providing detailed guidance to meet specific requirements of New Zealand law and practices
- New Zealand and, as appropriate, Australian standards
- codes of practice, guidelines and published standards of various authorities.

Each part attempts to provide a broad coverage of the subject but avoids duplicating major elements of referenced documents, preferring to direct readers to the source.

The TCD manual and *Traffic control devices specifications* (TCD specifications) will, on completion, replace the joint Transit New Zealand and Land Transport NZ publication *Manual of traffic signs and markings* (MOTSAM).

Part 9 Level crossings

This part was developed with guidance from the Level Crossing Working group, a standing group convened by the NZTA. This group represents rail participants (KiwiRail and Federation of Rail Organisations of New Zealand (FRONZ)), road controlling authorities (RCAs), the Ministry of Transport and the NZTA.

Table A: Planned structure of the TCD manual

Part	Title	Outline of content – may vary as the manual develops
	Sign specifications	Detailed descriptions of traffic signs including dimensions, colour and layout
	Signal specification	Detailed descriptions of permitted traffic signal displays and dimensions and colours of signal aspects
	Marking specification	Detailed description of road markings, including dimensions, colours and layout
1	General requirements for traffic signs	Purposes of traffic signs and their legal foundation Materials and construction General design principles – size, lettering, legends Installation – location, mounting heights
2	Direction, service and general guidance signs	Route signing, including state highways, regional roads, bypasses, detours, scenic routes Street name signing, including design and location Services signing policy, application and design Tourist signing General information signs, eg public amenities, features
3	Advertising signs	Design and location principles Policies for billboards and other forms of roadside advertising
4	Traffic control devices for general use – at intersections	Treatments at intersections, including options for traffic control, advance warning, etc
5	Traffic control devices for general use – sections of road	Treatments between intersections, including delineation, curves, passing facilities, steep grades, etc
6	Speed management	Safe system approach to speed Signs and markings for speed limits Temporary and variable speed limits Local area traffic management
7	Parking controls (formerly part 13)	Legal framework – implications and responsibilities Design considerations and elements Linear and zone parking treatments Parking furniture, eg meters, vending machines
8	Code of practice for temporary traffic management	Code of practice for temporary traffic management and local body supplement
9	Level crossings	Risk assessment (ALCAM) Design considerations, eg facility types, traffic movements, stacking distance, sight distances Types of control – passive or active
10	Motorways and expressways	Specific signing and marking requirements for motorways and expressways
	Definitions	Definitions of terms used throughout the TCD manual
	References	All documents referenced throughout the TCD manual

Record of amendments

Amendment number	Description of change	Effective date	Updated by
Edition 2	Improvements as recommended by the Level Crossing Working group consultation.	July 2011	Bob Gibson
Edition 2, amendment 1	Editorial improvements following public review phase.	December 2012	Bill Greenwood

1.0 Introduction

1.1 Purpose

1.1.1 What's in this document?

Part 9 Level crossings, is part of a suite of guidelines within the *Traffic control devices manual* (TCD Manual) prepared by the NZ Transport Agency (NZTA).

The document is intended to provide best practice guidance on the use of traffic control devices related to level crossings to both road and rail practitioners. In particular, it builds on the specifications for approved signs, markings and other traffic control devices approved or mandated for use in New Zealand as set down in the *Traffic control devices specifications* (TCD specifications).

While the main intent of the document is to provide guidance on the use of traffic control devices, it also provides some guidance on operational policies affecting traffic movement across level crossings and activity (such as road works) on or adjacent to level crossings. In addition, it briefly describes some relevant duties and responsibilities of rail access providers, rail operators, road controlling authorities (RCAs), adjacent landowners and users.

1.1.2 Terminology – law or good practice

This document outlines the legal framework and responsibilities for the design and installation of traffic control devices at or near level crossings. This includes the general principles behind their use at the time the document has been drafted. It should not be used in substitution for professional advice as to compliance with relevant central and local government requirements.

The following terminology is used within the document to determine whether an aspect or statement made is a requirement under law or good practice. These terms are:

- **must** – indicates something that is mandatory or required by law
 - **should** – indicates a recommendation
 - **may** – indicates something that is optional and may be considered for use.
-

1.2 Level crossings

All level crossings must be protected through the use of appropriate traffic control devices. The devices installed will depend on a range of factors including:

- level crossing type
 - volume and speed of rail, and road traffic
 - mix of road and rail traffic using the level crossing
 - alignment of the approaches to the level crossing
 - other physical attributes of the level crossing and its surrounds.
-

1.3 Scope of document

This document describes traffic control devices used to control and warn traffic at, and in advance of, level crossings. It specifies the way in which these devices are used to achieve the level of control required for the safety of rail traffic and all road users. It also gives requirements and guidelines on the selection of an appropriate device and on their location and installation.

1.4 Definitions

Rail access provider	The person who controls the use of a railway line by rail operators (including that person if it is also a rail operator), whether or not that person engages rail personnel to exercise or assist in exercising that control on its behalf, but does not include those rail personnel (Railways Act 2005, section 4).
Rail operator	A person who provides or operates a rail vehicle, whether or not that person engages rail personnel to do so or to assist in doing so on its behalf, but does not include those rail personnel (Railways Act 2005, section 4).
Rail participant	A rail participant may be an infrastructure owner, a rail vehicle owner, a railway premises owner, an access provider, a rail operator, a network controller, a maintenance provider, a railway premises manager or any other class of person prescribed as a rail participant by regulations (Railways Act 2005, section 4).
Railway premises owner	A person who owns, or leases for a period of seven years or more, any railway premises, whether or not that person engages rail personnel to exercise or assist in exercising the rights and duties of ownership on its behalf; but does not include those rail personnel (section 4 Railways Act 2005).

1.5 Engineering judgement

This document provides rules, standards and guidance on the use of traffic control devices. However, practitioners should always apply sound engineering judgement in the use and installation of these devices to ensure they will be effective at any particular site.

1.6 Value for money

The Land Transport Management Act 2003 (LTMA) sets out a framework for planning, programming and funding land transport activities. It encourages integrated long-term planning and allows funding flexibility to achieve an affordable, integrated, safe, responsive and sustainable land transport system.

The LTMA requires the NZTA and approved organisations which receive payments from the National Land Transport Fund (NLTF) to use this revenue in a manner that seeks value for money. Value for money can be defined in a variety of ways but in general it means selecting the right things to do, implementing them in the right way, at the right time and for the right price.

The NZTA's *Knowledge base* describes processes for funding from the NLTF and is aimed at strategic and tactical levels. The value for money concept which drives those processes should be applied to every element of the road network, including the use of the traffic control devices described in the TCD manual and, in particular, this part.

1.7 All practical steps

The Railways Act 2005 has, as its stated purpose, the promotion of rail operation safety and the definition of the duty of rail participants to ensure safety. The Act requires rail participants to take all practicable steps to ensure that no rail activity causes or is likely to cause the death or serious injury of individuals. Thus, there is a duty for rail participants to take all practical steps to provide safety at level crossings.

The Act allows for cost to be one of the considerations in determining what constitutes 'all practical steps'. This is consistent with the value for money concept in the LTMA. Participants have limited financial resources and must apply these to manage risks in a cost-effective way. This document describes a risk assessment model, Australian Level Crossing Assessment Model (ALCAM) - see section [3.0 Risk assessment and ALCAM](#)) which utilises the guidelines contained in this document, to determine levels of risk and identify practical and cost-effective remedial measures. ALCAM can then assist in the development and implementation of a prioritised remedial programme for level crossings.

In determining remedial measures the practitioner need to consider, but not solely rely on, conventional cost-benefit analysis. Level crossings are different from roads in that the overall risk profile is skewed toward low-probability but high-consequence events (particularly on passenger train routes). In this sense, rail is similar to the aviation industry in that a single event has the potential to have catastrophic consequences.

In addition, there are comparatively few accidents at level crossings, meaning that any prioritisation of level crossings needs a more proactive approach (ie ALCAM).

As level crossings are the intersection of the rail and road networks their safety requires the integration of 'value for money' and 'all practical steps'. It also requires a partnership between RCAs and rail participants to ensure both are able to meet their statutory objectives.

2.0 Responsibilities for level crossings

2.1 General principles and powers

New Zealand's rail corporation, KiwiRail, is the primary rail access provider in New Zealand. Much of the rail policy described in this document is based on KiwiRail documentation and should generally be compatible with other access providers. However, there are over 70 licensed rail access providers (or operators) whose policies and operating procedures may differ in detail to some degree.

It is important, therefore, for both the rail access providers and RCAs to understand their respective legal responsibilities, recognise the possibility of differences in procedures and work closely to ensure level crossings and adjacent roadways, and railway lines operate safely and effectively.

Appendix E provides a basic guide to responsibilities of RCAs, rail participants and land owners at level crossings.

2.2 What is a level crossing?

Section 4 of the Railways Act 2005 defines a level crossing:

- (a) means any place where –
 - (i) a railway line crosses a road on the same level, or
 - (ii) the public is permitted to cross a railway line on the same level; and
- (b) includes a bridge used for both rail vehicles and road traffic on the same level; but
- (c) does not include a railway line on a road that is intended solely for the use of light rail vehicles.

In the Railways Act 2005, a road has the same meaning as in section 315 of the Local Government Act 1974, rather than the meaning described in the Land Transport Act 1998. As a result, the definition of level crossing in the Railways Act 2005 is narrower than that intended for this document, which includes, eg private and rail operations level crossings. It is important to stress the Railways Act 2005 is not silent on these level crossings and defines a wide range of responsibilities on rail access providers, landowners and users for the safe management of these places.

Traffic control devices and road user obligations are defined in legislation made under the Land Transport Act 1998, and, for the purposes of this document, the broader definition of road in that Act is more appropriate. Therefore, a level crossing is defined for the purpose of this document as a place where users of a formed path or road cross a railway line at the same level.

2.3 Legal status of level crossings

Historically, there have been two situations in which the need for a level crossing has arisen. This has resulted in two broad categories of level crossing – statutory (since 1894) and deed of grant (of right of way).

This document does not deal with any aspect of legal or implied obligations related to cost sharing including construction and maintenance cost.

2.3.1 Statutory

This category arises where the construction of the railway line interferes with the existing rights of a landowner or RCA, and is provided for in two sections of the Public Works Act 1981 (or in similar provisions of earlier statutes after 1894).

Section 166(d) provides, in respect of any railway authorised under that or any other Act, the responsible minister may '*... make the railway on, across, over, or under any road, motorway, access way, service lane, railway, tramway along the defined middle line; and alter the level of any road, access way, motorway, service lane, railway, or tramway for that purpose*'.

Section 169(1) provides that, where the construction of the railway line has '*... cut off all access by road to any land other than Crown land; or separated one piece of the land of any person from another piece of land of that person ... , the Minister shall provide access to the land so separated*'. Access can be provided by constructing a new road, access way or service lane, or by provision of a level crossing.

Where the land has been subdivided after the construction of the railway, there is no obligation under this section to provide access.

2.3.2 Deed of grant

This category occurs where, sometime after the construction of the railway, an adjacent landowner or RCA seeks the construction of a level crossing. In such cases, level crossings have been created pursuant to a statutory right to grant easements of right of way, as exemplified by section 35 of the New Zealand Railways Corporation Act 1981 (NZRCA) or by exercise of common law powers available to all landowners.

Section 35 of the NZRCA allows for the grant by KiwiRail of an easement of right of way across or along any railway owned by KiwiRail. Other operators must rely on common law rights of a landowner for similar powers.

2.3.3 Section 75 Railways Act 2005

The exercise of powers under both statutory and common law easements will be affected by section 75 of the Railways Act 2005 which governs how access to the railway corridor is managed. Section 75 operates to limit the exercise of some rights under easements and provides protection to railway participants (including licensed access providers, railway premises owners and railway operators (all defined in the Railways Act 2005)), by requiring all third parties seeking access to the rail corridor to obtain the consent of the licensed access provider or railway premises owner (through the permit to enter process) before entering the railway to undertake work on or at a level crossing or railway premises.

2.3.4 Maintenance obligations

With respect to statutory level crossings, the obligation to maintain the level crossing appears to lie with the rail access provider or rail operator. The documents granting the easement of right of way under section 35 of the NZRCA or at common law would normally specify which party has responsibility for maintenance of the level crossing, including the installation and maintenance of any traffic control devices.

2.3.5 Traffic control devices at public level crossings

Section 81 of the Railways Act 2005 provides licensed access providers with the power, but not a duty, to install warning devices at level crossings. The determination of the exact level of protection to be provided is at the discretion of the licensed access provider after consultation with other affected persons, including (but not limited to) the relevant RCA and adjacent landowners.

Clause 9.2(1) of the TCD Rule imposes a duty on the RCA to install warning signs in advance of a level crossing on a public road, and authorises the installation of such signs on other roads. Clause 9.3(1) imposes a duty to install specified road markings in advance of a level crossing on a road that has a speed limit of 70km/h or more, or that is multilane.

Clause 9.2(2) reflects section 81 of the Railways Act 2005, and provides that a rail access provider, after consultation with the RCA, may install warning signs and other traffic control devices at a level crossing.

Clauses 9.3(4) and 9.4, however, effectively provide that any access provider that does install warning signs or other traffic control devices at a level crossing must ensure that those signs and other traffic control devices comply with the requirements of the TCD Rule.

Table 2.1 Classification of level crossings

	Public	Private
Statutory (post-1894)	Section 166 of the Public Works Act 1981 (or earlier provision). Built across existing road.	Section 169 of the Public Works Act 1981 (or earlier provision). Construction of railway has split land or cut it off from road access.
Deed of grant (of right of way)	Section 35 of the NZRCA (or earlier provision)/common law. RCA's request for deed of grant for public level crossing where road built across existing railway - at nominal rental only.	Section 35 of the NZRCA (or earlier provision)/common law. Landowner request for deed of grant for private level crossing to access private property.

2.4 Types of level crossings

2.4.1 Public level crossings

Public level crossings can be level crossings on legal roads or on operational railway land. Many of these level crossings are subject to a deed of grant, which sets out the conditions on which each is provided and maintained.

There are two types of public level crossings:

1. Pedestrian level crossings

These level crossings provide for the passage of foot traffic, mobility devices, wheeled recreational devices and, frequently, cyclists. They may be within a road reserve but separated from the roadway (eg by a berm) or they may be isolated, stand-alone level crossings, including level crossings at station platforms.

2. Vehicular level crossings

Vehicular level crossings include all level crossings carrying road vehicles. These level crossings may incorporate adjacent footpaths to cater for pedestrian level crossings of the railway track. Where there are no adjacent footpaths, the vehicular level crossing could also cater for pedestrians, mobility devices and wheeled recreational devices.

2.4.1.1 Changes of use or reconfiguration of public level crossings

Any proposed change in the use, location or configuration of a level crossing is subject to both the approval of the rail access provider or railway premises owner and the issue of a deed of grant. Changes required to upgrade a level crossing to a new standard by anybody other than the rail access provider must be referred to the rail access provider for agreement.

2.4.2 Private level crossings

2.4.2.1 Statutory level crossings

Statutory level crossings were provided by statute at the time the railway was constructed and were needed to give legal access to severed portions of private land where no other legal access existed. Only one statutory private level crossing can exist per landholding, unless the original landholding had more than 1.6km (one mile) of railway frontage.

These level crossings have never been systematically recorded and the statutory right can now only be ascertained by reference to the original land title deeds as they applied immediately before and after the creation of the railway.

A private level crossing that may have been a statutory level crossing at the time a particular railway line opened may cease to be so if the severed land it served was later subdivided or had alternative legal access provided to it. In these circumstances, and if the level crossing is to be continued, it would become a private granted level crossing subject to conditions set out in a deed of grant with the appropriate rail access provider. However, many level crossings in this category have not been properly documented following their change of status.

2.4.2.2 Granted level crossings

These are private level crossings that have generally been provided subsequent to a railway's opening and for which deeds of grant set out the conditions on which each is provided and maintained. In some circumstances, a statutory private level crossing can alter in status to a granted level crossing and be subject to a deed of grant.

2.4.2.3 Non-statutory or non-granted level crossings

Private level crossings that are neither statutory nor granted are not legal until formally documented by the appropriate rail access provider.

2.4.2.4 Changes of use of granted level crossings

Where a deed of grant has been issued for the use of a private level crossing, the grantee may not change the use of that level crossing without the prior written consent of the rail access provider or railway premises owner and an amendment to the deed issued. Where agreement is denied, the level crossing use cannot be changed.

RCAs must clarify level crossing status with the rail access provider or railway premises owner where applications for subdivision and road access to the same involve level crossings. This applies regardless of whether the intended use is temporary or permanent.

2.4.3 Rail operations level crossings

Rail operations level crossings are level crossings located within rail property (eg marshalling yards, depots or the rail corridor) where the road or path is owned and maintained by the rail access provider or rail operator. Rail operations level crossings are used in the operation of rail business and are generally, although not always exclusively, provided for rail personnel. Thus, these types of level crossing are often not available for general public use and commonly have only limited access (see section 11.0 [Requirements for rail operations level crossings](#)).

2.4.4 Tramway level crossings

Tramway level crossings are defined as level crossings that are:

- not in the public domain but are part of heritage or museum operations that are accessible by patrons, or
- part of street infrastructure that by its nature intersects with road and pedestrian level crossings.

It should be noted that tramway level crossings are specifically excluded from the Railways Act 2005 definition of level crossings, as tramways are '*railway line(s) on a road that (are) intended solely for the use of light rail vehicles*' (see section 12.0 [Requirements for tramway level crossings](#)).

2.5 New level crossings

The provision of new level crossings is discouraged. Preferred alternatives are:

- grade separation, or
- closure of one or more existing level crossings where the new level crossing will better cater for the demand and manages risks better than the closed level crossing or crossings.

Where there are believed to be no reasonable alternative solutions, applications should be forwarded to the rail access provider or railway premises owner for consideration. The application would be expected to provide detailed justifications and plans. The application is likely to require future projections of likely traffic movements, particularly as they might affect the provision of active control at the level crossing.

Any new level crossing would be expected to meet the current design criteria of the rail access provider.

The rail access provider may grant temporary (often limited to two years) private level crossings for logging or construction work access, provided design requirements are met.

If a new or temporary level crossing is approved, a deed of grant would be required before the level crossing is brought into use.

2.6 Closure of level crossings

Many overseas jurisdictions have developed deliberate policies to reduce the number of level crossings. While New Zealand does not have a formal policy to close level crossings, it is clearly desirable to reduce, whenever practicable, the number of level crossings.

2.6.1.1 Public level crossings

To close a level crossing built across a pre-existing public road, the rail access provider must have an agreement in writing from the RCA. This would normally have followed extensive consultation. Once it is agreed the level crossing is to be closed, public notification of the closing is arranged and the closure follows. There may be other closure clauses included in respect of a deed of grant crossing.

2.6.1.2 Private statutory level crossings

These may be closed when the consent of the adjoining owner or owners has been obtained.

When ownership of land has changed so that there are different owners on opposite sides of the railway line, or where alternative access has become available at a statutory level crossing, the purpose for which the level crossing was originally provided is no longer valid and the level crossing may be closed under section 169 of the Public Works Act 1981.

2.6.1.3 Public and private granted level crossings

With granted level crossings, a clause is usually inserted in the deed of grant giving the rail access provider the right to close such level crossings. Where there are valid reasons for closure, the procedure described in the deed of grant is followed.

2.6.1.4 Non-statutory or non-granted level crossings

Private level crossings that are neither statutory nor granted are not legal until formally documented by the appropriate rail access provider, and may therefore be closed by the rail access provider unless such a grant is sought and obtained.

2.7 Out-of-service railway lines

Where a railway line ceases to be used and the period of disuse is likely to be of sufficient duration, the RCA should clarify the status of the level crossings with the rail access provider to ensure appropriate and safe use by road users.

When a railway line is unused, regular users may be in the habit of ignoring any warning signs. They are often unprepared for other drivers who slow down or, in the case of passenger service vehicles, actually stop at any level crossing on the unused railway line. For regular users, the warning signs cease to have relevance and their impact when used at other level crossings is reduced, as drivers' behaviour at the unused level crossing may be transferred to these other sites.

In many cases, traffic will be local only and very low volume, and risks at these sites are extremely low. However, there are implications arising from transferred behaviour patterns or a reduced perception in the value of the standard warning signs. In other more heavily trafficked locations, the behaviour of non-local traffic may lead to increased risks, particularly for local traffic.

Taking no action is inconsistent with principles of sound traffic management and formal identification that the railway line is not in use is recommended.

As long as signs and railway lines are in place, there are legal obligations on RCAs and road users, particularly the drivers of some types of vehicles. Signs could perhaps be removed but some residual confusion on the part of road users might still persist as long as the railway lines remain. The possibility of the railway line being reopened or some other reason may lead to a reluctance to remove or cover sections of the disused track across roads.

Identification may be achieved by the removal of any signals, warning signs or markings and would largely overcome the issues described above. However, as long as the tracks remain across the roadway, there would remain some potential for confusion. Installing a Railway Not In Use (AX12) sign at the level crossing should help overcome this and reinforce the status of the level crossing. The policy for the use of this sign is detailed in section 4.3 [Signs used at level crossings](#).

2.8 Reopening of railway lines

Where a railway line is to be reopened after a period of disuse the rail access provider should advise and work closely with the affected RCAs where level crossings will be reinstated. Actions required at each level crossing should include the following:

- A risk review and the implementation or programming of appropriate risk mitigation (eg the imposition of short-term limitation on train speed below the line speed that would be normally applied).
- Installation of necessary signs, markings or other devices including the use of temporary warning signs reminding road users trains are now running (see section [4.0 Traffic signs](#))

Appropriate publicity to ensure regular users of the road are aware that trains will again be using the railway line.

2.9 Trespass

Trespass is legally defined in section 73 of the Railways Act 2005. It states, in part, that a person must not, without the authority of the appropriate access provider or railway premises owner:

- enter any railway infrastructure or railway premises
- encroach on any railway infrastructure or railway premises by constructing or placing any obstacle
- do any act in which a ditch, drain or watercourse is filled up, diverted, altered, stopped or obstructed
- dig up, remove, alter or undermine the soil or surface of any railway infrastructure or railway premises
- interfere with, change or move a structure or property in a manner that causes damage.

Access to the railway by easements or for works is covered in section 75 of the Railways Act 2005. It states, in part, that no one may exercise a right under an easement or carry out work on, over or under any railway infrastructure or railway premises, without the prior written permission of the appropriate access provider or railway premises owner.

The access provider or railway premises owner must consult with any other rail participants who may be affected by the easement or work and, subject to a reasonable fee being paid, may issue a permit setting out the conditions under which any permission is granted.

The access provider or railway premises owner may refuse to grant a permit only if it has reasonable grounds in relation to the carrying out or safety of rail activities.

See [Appendix C - Working on or near level crossings](#) for requirements for working on or near the railway corridor.

3.0 Risk assessment and ALCAM

3.1 Introduction

The Australian Level Crossing Assessment Model (ALCAM) is a safety assessment tool used to help prioritise disparate level crossings according to their comparative safety risk. It provides a rigorous defensible process for decision making for road and pedestrian level crossings, as well as a method to help determine the optimum safety improvements for individual sites.

At the May 2003 Australian Transport Council (ATC) meeting, all state and territory transport ministers agreed to adopt this innovative method of risk assessment. ALCAM is currently applied across all Australian states and territories. ALCAM is overseen by a committee of representatives from these states and territories to ensure its consistency of development and implementation.

ALCAM has been adopted for use in New Zealand. All level crossings throughout New Zealand have undergone an initial ALCAM assessment. These were undertaken through a project jointly funded by KiwiRail and the NZTA.

The ALCAM assessment includes both road and pedestrian level crossings. An outline of the ALCAM process is included in [Appendix D - Australian Level Crossing Assessment Model \(ALCAM\)](#).

3.2 ALCAM description

ALCAM is an assessment tool designed to identify site-specific risks and help the user to identify and prioritise level crossing safety improvement works. It comprises of three separate components:

1. infrastructure model
2. exposure model
3. consequence model.

Each of these models has a single factor as an output that, when combined, produces a risk score for each level crossing:

ALCAM risk score = infrastructure factor x exposure factor x consequence factor

The infrastructure factor is the output of a complex scoring algorithm that considers how physical properties at each site will affect human behaviours. This factor modifies the accident probability per year to reflect unique site conditions.

The exposure factor is a function of control type, vehicle (or pedestrian) volumes and train volumes. This is expressed as an accident probability per year.

The consequence factor is the expected outcome in the event of a collision and includes deaths and injuries on both the train and vehicle. This is expressed in terms of effective fatalities per collision. For road level crossings the consequence factor varies between level crossings. However, the factor is fixed for pedestrian level crossings.

The ALCAM risk score is expressed in terms of an expected number of fatalities per year.

The weightings inside the model have been determined through a series of workshops by an expert group, including representatives from each mainland state of Australia, KiwiRail, the NZTA and with expertise in road and rail engineering. In excess of 100 individuals, primarily from Australasia's road and rail jurisdictions, have been involved in the development of ALCAM from its conception in 1999 through to the present. The model has been validated against a combined dataset of 10 years of Australian and New Zealand level crossing collision data (-2000-2009).

ALCAM can be used to:

- quantify the probability of an accident
- quantify the expected consequences of an accident
- compare the relative risk across crossings within a region or jurisdiction
- carry out a cost-benefit analysis of any improvements
- highlight where specific risks exist
- model the effect of cost-effective treatments to address these risks.

A total data management system is provided (the Level Crossing Management System - LXM) to allow for the effective management of ALCAM data as well as other important information. LXM contains a number of addition reporting and modelling tools to assist with the overall decision-making process. The model should be applied by road and/or railway engineers trained by approved ALCAM instructors.

3.3 Assessment of level crossings

Appendix A provides a detailed list of characteristics, controls and accident mechanisms used in ALCAM. The following briefly describes some of the more critical elements that must be measured for input into the model.

3.3.1 Level crossing geometry and environs

The geometry and environ elements include:

- number of operational railway lines, including shunting lines
 - number of traffic lanes each way – view along the railway line could be obstructed by traffic in adjacent lane
 - grade on each approach to the railway line(s) – critical when the railway forms a 'hump' in the road affecting the passage of heavy and long vehicles across the railway lines
 - skew of the road to railway line – view along railway line affected by degree of skew
 - proximity to sidings, road intersections and other traffic generation.
-

3.3.2 Traffic characteristics

Traffic characteristics recorded include:

- volumes, by categories, of road vehicles, pedestrians and rail vehicles
 - operating speeds of these users.
-

3.3.3 View lines/ visibility

Much of the data described above are essential inputs into calculation of the view lines required at the level crossings for both drivers and pedestrians.

For drivers, there are two critical view lines considered:

- the restart view line – the minimum distance, along the railway line(s) from the driver's eye position in a vehicle at the stop line position of the closest railway line, required to allow the driver to start from a stopped position and clear the railway line before a train arrives
- the road approach visibility line – the minimum distance along the railway line(s) from the level crossing that either:
 - a driver is able to see a train and stop before reaching the level crossing, or
 - a driver continues at the approach speed and crosses the level crossing safely ahead of a previously unseen train or a train far enough away to be clearly not a collision threat.

The best possible views must be maintained at level crossings. [Appendix B - Sight distances at level crossings](#) details the formulae used in determining the views required utilising a range of relevant driver, vehicle, road and rail parameters.

3.4 Other considerations

Although it is a comprehensive tool for the assessment of level crossing hazards, ALCAM cannot be applied in isolation. Any risk assessment and treatment also needs to consider other factors, including:

- collision and near miss history
- engineering experience (both rail and road)
- local knowledge of driver or pedestrian behaviour
- social and economic assessment
- standards and international best practice.

ALCAM does not provide warrants for upgrades or attempt to define a safe or acceptable level of risk. This is a decision for each jurisdiction and will depend on the standard of existing crossings, upgrade budgets and the level of risk that they are prepared to tolerate.

It is also very important to ensure that all stakeholders associated with the particular level crossing are involved with the determination of the final recommended treatment.

4.0 Traffic signs

4.1 Introduction

This section provides guidance on the use and placement of approved traffic signs.

The responsibilities of the rail access provider and RCA relating to the installation of signs is described in section 2.3.5 [Traffic control devices at public level crossings](#). Section 9 of the TCD Rule details specific legal requirements for level crossings, while schedule 1 in part 3 provides specifications for the signs that may be used.

In particular, clause 9.2 of the Land Transport Rule states:

9.2(1) *To inform road users of a level crossing and to promote safe responses from road users approaching and crossing the level crossing, a road controlling authority:*

(a) *must install warning signs on a public road in advance of the level crossing; and*

(b) *may install warning signs on any other road in advance of a level crossing; and*

(c) *may provide other traffic control devices in advance of the level crossing.*

9.2(2) *A rail access provider, after consultation with the road controlling authority, may install warning signs and other appropriate traffic control devices at a level crossing to promote safe responses from road users.*

4.2 General specifications

4.2.1 Sign size

For permanent traffic signs on urban roads, the smallest sign plate described in the TCD specifications is normally installed. For example warning signs would be a minimum of 600mm × 600mm. However, 750mm × 750mm or larger signs should be installed where the RCA deems it necessary due to traffic conditions and visibility.

On rural roads, the sign size is increased and the largest sign specified would normally be installed where operating speeds are higher than normal (eg 85 percentile speed exceeds 100km/h). Thus, for warning signs on rural roads operating at normal speeds, the warning sign plate size is 750mm × 750mm, while on roads where speeds are higher, 900mm × 900mm or larger signs should be installed.

Any supplementary sign component of a traffic sign assembly should match the size of the main component of the combination.

All supplementary signs are mounted 100mm below the main diamond sign or 100mm below any other supplementary sign in the order specified.

4.2.2 Placement and number of signs

It is important to carefully assess the placement and orientation of signs at level crossings to ensure a driver approaching from any direction receives adequate warning or instruction.

The alignment of the road relative to the railway line and the location of the level crossing in relation to nearby driveways or intersections can lead to unusual driver approach angles that need to be taken into account. However, these alignment and location issues can also lead to a large number of signs in close proximity with the possibility of:

- some signs being obscured by others, or
- drivers being incapable of fully comprehending all of the messages trying to be conveyed.

4.3 Signs used at level crossings

Signs installed at level crossings (ie adjacent to or within the railway corridor) are the responsibility of the rail access provider in consultation with the RCA.

Table 4.1 List of signs used at level crossings

Sign code	Sign type
RP1	Stop
RP2	Give Way
WX6	Crossbuck standard
WX61	Crossbuck with target board
WX62	Crossbuck with target board - private level crossing
WX63	Crossbuck plus [number of] Tracks with target board - private level crossing
WX7[n]	Supplementary [number of] Tracks
AX11	Bells Off
RP61	Stop On Red Signal
WX8	Look For Trains Pole used for sign, signal or barrier arm assemblies
RPB	Barrier arms
RPX1	Level crossing - Flashing Light assembly
RPX2	Level crossing - Stop assembly
RPX3	Level crossing - Give way assembly
RPX4	Private level crossing - Stop assembly
RPX5	Private level crossing - Give way assembly
AX12	Railway not In use
T235	Trains running

4.3.1 Stop (RP1) or Give Way (RP2)



RP1



RP2

Policy: A Stop (RP1) sign is installed as part of an RPX2 or RPX4 assembly and a Give Way (RP2) sign as part of an RPX3 or RPX5 assembly, at level crossings not controlled by signals or permanent level crossing keepers. The decision as to whether a Give Way or Stop sign is appropriate is primarily based on the view lines available at a level crossing determined by applying the criteria described in [Appendix B - Sight distances at level crossings](#).

The minimum requirement on any approach to a level crossing is a Give Way control in the following circumstances:

- If the approach visibility (S_2) can be met, a Give Way sign must be installed.
- If the approach visibility (S_2) cannot be met but the restart view (S_3) can be met, a Stop sign is installed.
- If the approach visibility (S_2) and the restart view (S_3) cannot be met, the crossing will need to be carefully assessed to determine whether active control is justified or changes to the operating conditions (eg restriction on road or rail speeds, limitations on vehicle length) need to be imposed.

Note: Until a level crossing has been surveyed and assessed using ALCAM, the existing view line criteria described in KiwiRail's G417 document (previously also incorporated in MOTSAM volume I, appendix A4) will apply.

Location: See details in relation to RPX2 and RPX3 assemblies.

4.3.2 Crossbuck (WX6 or WX61)



WX6



WX61 [a WX6 with target board]

Policy: Level crossing position indicators or crossbuck signs must be installed at all level crossings. Wherever possible, they should be installed as part of RPX1, RPX2 or RPX3 assemblies.

Installation of a crossbuck (WX6) sign in an RPX1 assembly (ie on poles also mounted with flashing lights and bells (FLB) or half-arm barriers (HAB)), while highly desirable, may be impractical in some cases because the existing poles could require major base stabilisation work.

Additional offsets can also be necessary to avoid fouling a raised barrier arm. Crossbuck signs may, in these circumstances, be mounted on a separate white pole as near as possible to the position indicated for RPX1 signs (figures A6, A7 and A8). Special care will be required to ensure that the visibility of the flashing lights is not obstructed in any way. Where necessary, the crossbuck sign may be mounted at a lower level, or even on the right-hand side of the approach road, to ensure they are clearly visible to approaching drivers.

Where increased conspicuity is required, the crossbuck (WX6) sign may be mounted on a red retro-reflective target board (WX61), to make it more effective when viewed against a visually complex background or a background that is of light colour for a substantial proportion of the time. The size of the crossbuck (WX6) sign should be determined from table 4.2 below.

Table 4.2 Sign size WX6

Speed limit (km/h)	Sign size
Rural (≥70km/h)	Standard WX6 (boards 1500mm wide × 300mm high) <i>must</i> be used on all rural roads
Urban (<70km/h)	Standard WX6 should normally be used in all situations but a smaller sign (boards 1000mm × 200mm) <i>may</i> be used at restricted sites

The size of the crossbuck with target board sign (WX61) should normally be 1755mm wide x 1313mm high. In urban and low-speed rural environments a smaller sign (1170 x 875 mm) *may* be used.

4.3.3 Crossbuck for private level crossings (WX62 or WX63)



WX62



WX3

Policy: Where a private level crossing operates with low-road speeds and has a narrow, unsealed road formation, some reduction in the size of the crossbuck can be justified. The crossbuck for private level crossings (WX62 or, where there is more than one railway line, WX63) may be installed alone or preferably above either a Stop sign (RP1) or Give Way sign (RP2). The use of either an RP1 or RP2 sign is based on the sight lines at the level crossing described above.

4.3.4 Tramway crossbuck (WXT)

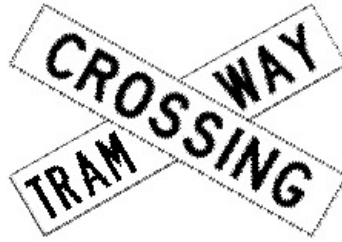

WXT



WXT1 [a WXT with target board]

Policy: Where a tramway crosses a road and the trams that use it have right of way, similar standards to those applying to railway level crossings apply. In these cases, the standard crossbuck (WX6 or WX61) is replaced by a tramway crossbuck (WXT or WXT1) sign. See also section 12.0 Requirements for tramway level crossings.

4.3.5 Crossbuck for private level crossings (WX62 or WX63)



WX7[2]



WX7[3]



WX7[4]

Policy: An appropriate [number of] Tracks sign must be added to RPX1, RPX2 or RPX3 assemblies and incorporated into a WX63 private level crossing crossbuck where more than one railway line is crossed. The WX7[n] sign is never installed separately.

Sign size: Sign size is determined by the size of the crossbuck (WX6) used, as indicated in table 4.3 below.

Table 4.3 Sign combinations

Size of crossbuck (WX6)	Size [number of] Tracks (WX7[n]) sign
board 1000mm × 150mm	280mm high
board 1500mm × 200mm	420mm high

4.3.6 Bells Off (AX11)



Policy: In suburban residential locations, level crossing alarms may have been programmed to alter the ringing of bells outside normal waking hours. Where this is the case, the rail access provider will have installed the Bells Off sign on the FLB pole.

At level crossings equipped only with FLB, the sign will indicate the period that the bells will not operate.

At level crossings equipped with barrier arms, the sign indicates the period during which the bells only sound until the barrier arms have lowered fully to the horizontal position. This is necessary to warn cyclists and pedestrians of the hazard of the lowering arms.

Switching off the bells lessens the safety of cyclists and pedestrians.

4.3.7 Stop on Red Signal (RP61)



Policy: A Stop On Red Signal sign may be added to RPX1 assemblies to emphasise the requirements for drivers to stop when the level crossing flashing signals are operating.

Location: Stop On Red Signal signs must be mounted on RPX1 assemblies with a minimum clearance of 1.m from the underside of the sign to the surface of the adjacent roadway, trafficable shoulder or top of kerb, whichever is the critical dimension.

4.3.8 Look For Trains (WX8)



Policy: A Look For Trains sign (WX8) may be used on RPX2 and RPX3 assemblies. It may also be used as a supplementary sign below level crossing alignment (WX40-WX42) signs (see [4.4 Signs used in advance of level crossings](#)).

A WX8 sign should be installed separately at a pedestrian maze (refer to section [8.0 Requirements for pedestrian and cycle level crossings](#)). They may also be installed where there is no pedestrian maze at a footpath (separated from a road) crossing the rail corridor.

4.3.9 Poles used for mounting signals, barrier arms and signs

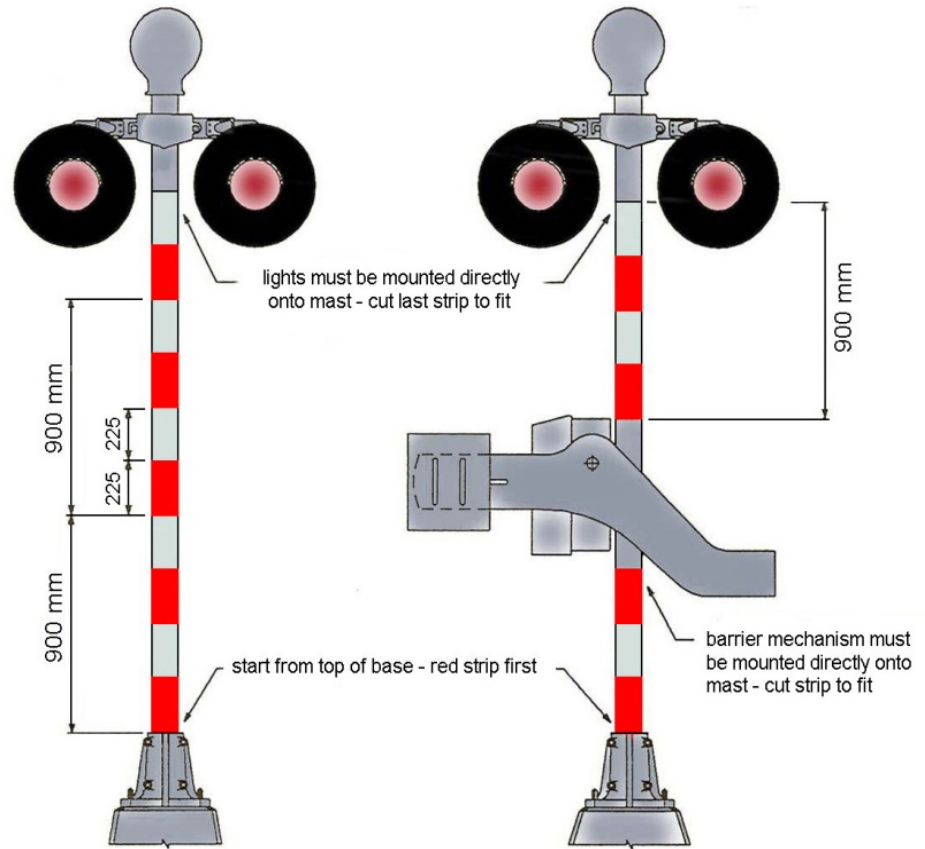

Poles used for mounting signals should have reflectorised red and white alternate bands at least 225mm wide. Poles used to mount signs at level crossings may have similar reflectorised red and white alternate bands but, if not, the pole should be painted white.

Barrier arms may be mounted on separate posts behind but in line with the RPX1 assembly. A separate pole may be used when:

- a. it is not practical to mount the flashing signals and WX6 sign on the same pole because of the required angle for the signals and sign, or
- b. the barriers have been added to an existing FLB installation.

When the barrier is on a separate pole, the barrier pole is seldom visible to motorists from a distance and thus there is little value in installing reflectorised bands.

4.3.10 Barrier arms

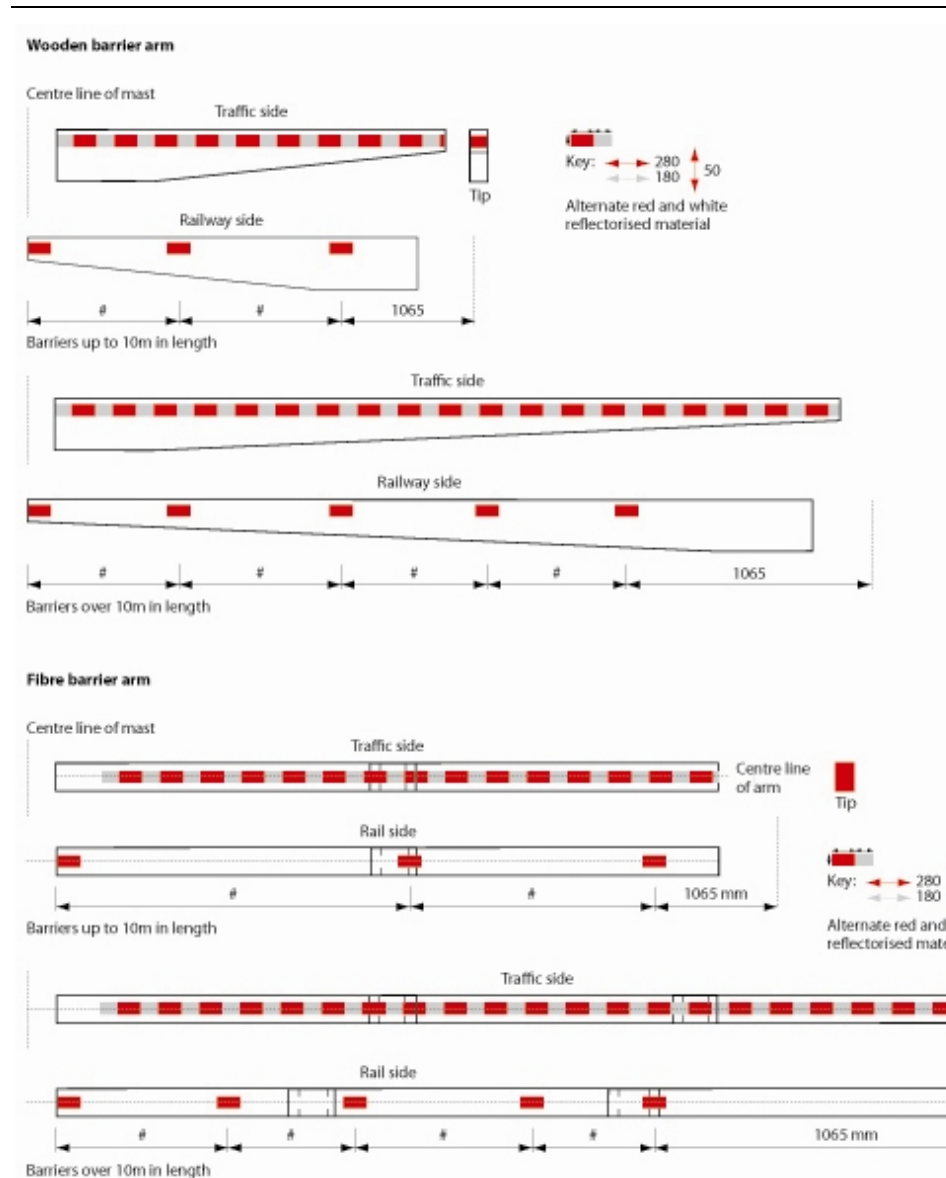

Policy: A barrier arm must have:

- on the front (traffic side), a strip 50mm high of alternate red (280mm wide) and white (180mm wide) retro-reflective markers, and
- on the reverse (rail side), a pattern of inline, equally spaced red (50mm high, 280mm wide) retro-reflective markers, at least:
 - three (on arms up to 10m long), or
 - five (for arms greater than 10m long).

Any area of the arm not covered by the markers must be white.

Barrier arms should be extended to the centreline of the road.

All parts of the barrier arm or, depending on the skew of the railway line relative to the road, the barrier counterweight must be at least 1.7m from the nearest rail.

4.3.11 Level crossing flashing light assembly (RPX1)

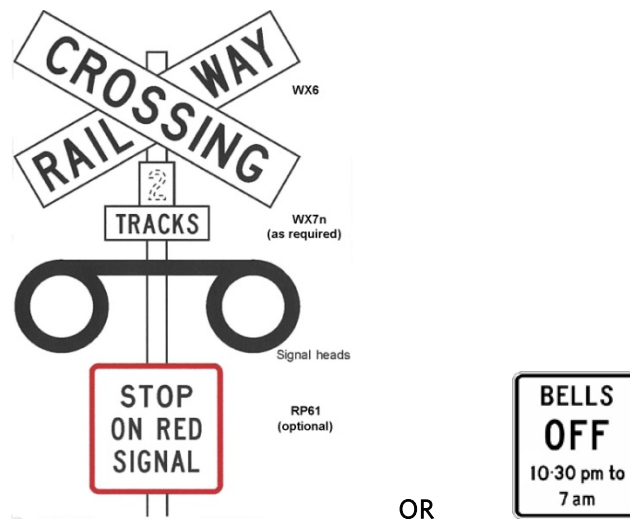

Policy: A basic level crossing flashing light assembly (RPX1) consists of a crossbuck (WX6) sign mounted above the signal head on a signal or barrier pole. The pole forms part of the assembly. A supplementary [number of] Tracks (WX7[n]) sign must be added at level crossings with more than one railway line.

An optional Stop On Red Signal (RP61) sign may be added to emphasise the requirement for drivers to stop when the level crossing flashing lights are operating. A Stop On Red Signal (RP61) sign should only be used when a history of non-compliance exists at the level crossing.

If the bells are turned off at night, a Bells Off (AX11) sign must be installed.

Where increased conspicuity is required, the crossbuck (WX6) sign may be changed to a crossbuck with target board (WX61) to make it more effective. No other signs may be attached to an RPX1 assembly or its support.

Location: RPX1 assemblies, normally installed on the left-hand side of the road, must be at least 2.4m clear of the nearest rail edge (3m from the nearest railway line centreline). The limit line indicating the point where vehicles must stop if a train is approaching the level crossing should normally be installed 2m in advance of the RPX1 assembly.

RPX1 assemblies should be clearly visible to approaching drivers for a distance of at least 120m on rural roads and at least 60m on urban roads. The assembly may be placed on the right-hand side if the visibility cannot be achieved by installing it on the left-hand side and may be duplicated where the geometry means drivers approaching will benefit.

Where there are two or more traffic lanes on approaches to level crossings controlled by flashing light signals, a second RPX1 sign combination should, if practicable, be installed on any median island (see figure A8) or on the right-hand side of the road.

Sign size and detail: The normal, larger-sized crossbuck (WX6) and [number] of Tracks (WX7[n]) signs should be used in the RPX1 assembly in most situations. However, in restricted sites on urban roads, the smaller sizes of the WX6 and WX7[n] signs may be used. The gap between individual signs on the RPX1 assembly should be approximately 100mm.

Support poles for the assembly must be fully retro-reflectorised with alternate 225mm wide bands of red and white, as described above.

4.3.12 Standard level crossing Stop (RPX2) or Give Way (RPX3) assemblies

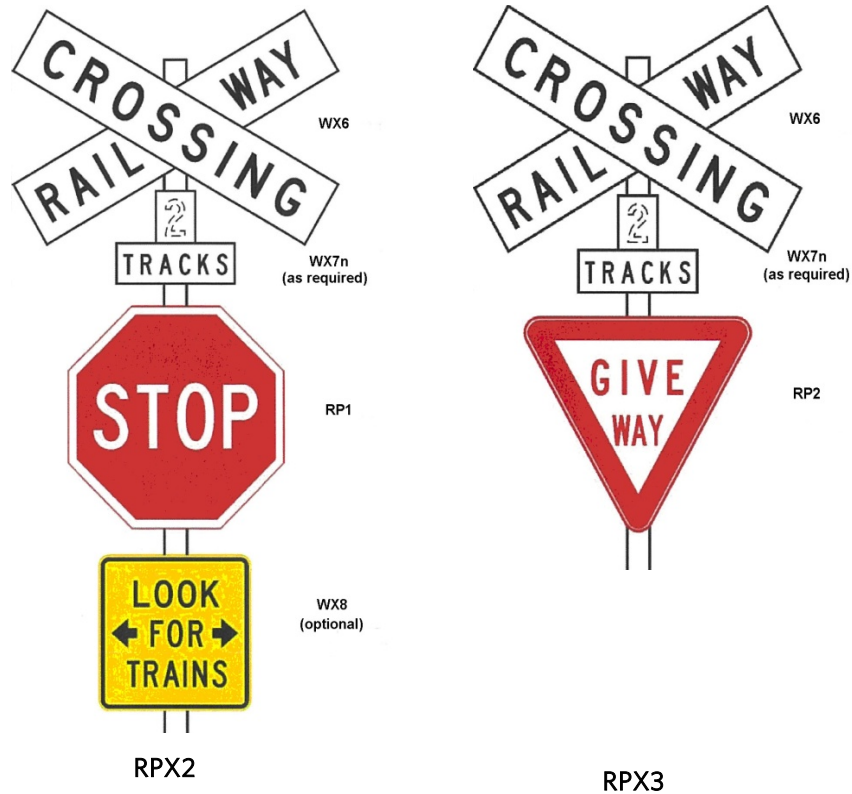

Policy: A standard level crossing stop assembly (RPX2) consists of a crossbuck (WX6) mounted above a Stop (RP1) sign, while a level crossing give way assembly (RPX3) consists of a crossbuck (WX6) sign mounted above a Give Way (RP2) sign. A supplementary [number of] Tracks (WX7[n]) sign is added at level crossings with multiple railway lines. An optional Look For Trains (WX8) sign may be added to emphasise the requirement for drivers to check for oncoming trains. The pole used to mount these signs is part of the assembly and may have reflectorised red and white alternate bands at least 225mm wide.

Where increased conspicuity is required, the crossbuck (WX6) sign may be changed to a crossbuck with target board (WX61) to make it more effective. No other sign may be attached to an RPX2 or RPX3 assembly.

Location: RPX2 and RPX3 assemblies, should be installed on both sides of the road, and must be at least 2.4m clear of the nearest rail edge (3m from the nearest railway line centreline). The limit line indicating the point where vehicles must stop if a train is approaching the level crossing should normally be installed 2m in advance of the RPX2 or RPX3 assembly.

RPX2 and RPX3 assemblies should be clearly visible to approaching drivers for a distance of at least 120m on rural roads and at least 60m on urban roads.

Where a level crossing on a side road is within 30m of the through road, the RPX2 or RPX3 assembly must be installed on both sides of the road and oriented toward approaching drivers (see examples for an RPX3 assembly in figures A9.1 and A9.2).

The recommendation to duplicate stop or give way passive signs was introduced in 2012. Cost considerations mean that it will take a number of years to phase these changes in. As such, duplication should be considered where the level crossing is being upgraded, or as part of a general sign or road maintenance program. This change is intended to apply to passive signs only and should not be used to infer a requirement for signals to be duplicated.

Sign size and detail: The normal, larger-sized crossbuck (WX6) and [number] of Tracks (WX7[n]) signs should be used in the RPX2 and RPX3 assemblies in most situations. However, in restricted sites on urban roads, the smaller sizes of the WX6 and WX7[n] signs may be used.

The minimum sizes for the Stop (RP1) on the RPX2 and Give Way (RP2) on the RPX3 assembly are given in table 4.4 below.

Table 4.4 Minimum sizes for Stop (RP1) or Give Way (RP2) signs on RPX2 OR RPX3 assemblies

Road operating speed V_{85} (km/h)	Minimum sign size (mm)	
	Stop (RP1)	Give Way (RP2)
< 70	675 x 675	750 x 865
70-100	845 x 845	900 x 1040
> 100	1015 x 1015	1200 x 1385

The gap between individual signs on the RPX2 assembly should be approximately 100mm.

4.3.13 Private level crossing Stop (RPX4) or Give Way (RPX5) assemblies



RPX4

RPX5

Policy: The policy for the use of private level crossing assemblies is described in section 10.0 Requirements for private level crossings.

4.3.14 Railway Not In Use (AX12)



Policy: (See also section 2.7 above [Out-of-service railway lines](#).) Where a railway line ceases to be used and the period of disuse is likely to be of sufficient duration, the RCA must clarify the status of the level crossings to ensure appropriate and safe use by road users.

The RCA should only proceed when they have received formal notification that the railway line is out of use and is unlikely to be used for a specified period.

All regulatory signs, ie Give Way (RPX3), Stop (RPX2) and flashing light (RPX1) assemblies, relating to the level crossing should be removed on all road approaches to the disused railway line and a Railway Not In Use (AX12) sign installed at the former positions of the regulatory signs. In the case of flashing light assemblies, the signal heads must be hooded or turned from view as an alternative to immediate removal.

All permanent warning signs and markings relating to the level crossing should be removed on all approaches to the disused railway line.

Railway Not In Use (AX12) signs, maintained by the RCA, should remain in place until the railway lines have been sealed over or removed from the roadway or the railway line reopened.

The railway lines at any level crossing must not be sealed over without the explicit written permission of the rail access provider.

Gates may be installed across the railway line to reaffirm the railway line is disused. Installation is subject to agreement between the rail access provider and the RCA. If installed, the gates should be installed a sufficient distance from the level crossing to allow a rail service vehicle to stop clear of the roadway while the gate is opened or closed, yet remain in clear view of drivers approaching the disused level crossing.

The RCA may not carry out any work within the railway corridor, including installation of the Railway Not In Use (AX12) signs or any gate that is installed, without the explicit written permission of the rail access provider.

The former level crossing remains as railway corridor until the land on either side of the road is released from railway designation.

If the rail access provider intends reopening the railway line, the RCA must be given advance notice (at least four weeks) and the Railway Not In Use (AX12) sign must be removed and regulatory signs (depending on available sight distances) must be installed before the level crossing is reopened to rail traffic. Note that, for this purpose, the use of the railway line by HI-RAIL or similar vehicles used for inspection and any routine maintenance of the disused railway line or rail corridor does not constitute a reopened railway line.

The installation of regulatory signs located at, and within, the railway corridor at any reopened level crossing remains the primary responsibility of the rail access provider in conjunction with the RCA.

Once notified that the level crossing is to be reopened, the RCA is responsible for the installation of standard permanent warning signs and markings outside the railway corridor.

4.3.15 Trains running (T235)



Policy: (see also section 2.8 Reopening of railway lines.) Where a railway line is reopened road users need to be reminded that trains are again running and the trains running sign should be installed for an adequate period after the train use has resumed.

This sign may also be used:

- where an event (eg a running or cycle race) may be occurring along the road and participants may believe movement of trains has been controlled for the duration of the event, or
- road works are taking place adjacent to, or including, the level crossing and road users may believe the movement of trains is being controlled or the level of roadwork activity requires reinforcement that trains are operating.

Location: The sign should be installed as near as practicable to the level crossing.

4.4 Signs used in advance of level crossings

Signs installed in advance of level crossings are the responsibility of the RCA in consultation with the rail access provider.

Table 4.5 List of signs used in advance of level crossings

Sign code	Sign type
WX1L	Level crossing ahead steam train facing right
WX1R	Level crossing ahead steam train facing left
WX2L	Tramway ahead tram facing right
WX2R	Tramway ahead tram facing left
WX11	Level crossing ahead exempt supplementary
WX3	Level crossing ahead flashing signals
RJ2E	Low-overhead clearance at electrified railway assembly
WA1	Stop ahead
WA2	Give way ahead
WX40	Level crossing at an acute angle to the left
WX41	Level crossing at right angles
WX42	Level crossing at an acute angle to the right
WX5	Cyclist take care railway lines
WXR1	Level crossing on controlled crossroad to the right
WXL1	Level crossing on controlled crossroad to the left
WXR2	Level crossing on controlled side road to the right
WXL2	Level crossing on controlled side road to the left

Sign code	Sign type
WXR3	Level crossing on uncontrolled side road to the right
WXL3	Level crossing on uncontrolled side road to the left
WXL4	Level crossing at controlled T-junction to the left
WXR4	Level crossing at controlled T-junction to the right
WXR5	Level crossing at uncontrolled T-junction to the right
WXL5	Level crossing at uncontrolled T-junction to the left
WXB1	Controlled intersection beyond level crossing
WXB2	T-junction beyond level crossing
WXB3	Short-stacking distance
RJ51	Route unsuitable for long vehicles
Distance ahead supplementary	
WG3(50)	Supplementary 50m ahead
WG3(100)	Supplementary 100m ahead
WG3(150)	Supplementary 150m ahead
WG3(200)	Supplementary 200m ahead
WX31	Active advance warning signal – prepare to stop
WX32	Active advance warning signal – hidden queue
WX33	Active advance warning signal – queued vehicles
WB1A	Active level crossing warning sign

4.4.1 Level crossing ahead steam train (WX1R or WX1L)



WX1L



WX1R

Policy: A level crossing ahead warning sign consists of the steam train symbol displayed on a standard warning plate. The level crossing ahead steam train (WX1R or WX1L) sign is generally installed separately but may also be supplemented by a Look For Trains (WX8) or Exempt (WX11) sign.

A steam train facing right (WX1L) must be installed on the left-hand side of the road on the approaches to level crossings.

It is recommended that, in addition to the WX1L on the left-hand side of the road, a steam train facing left (WX1R) sign is also installed on the right-hand side of the road:

- on roads with an AADT greater than 2000 vehicles per day
- on state highways
- where the level crossing is on a side road and 10–100m from the through road (see figures A9.2, A9.3 and A9.4).

Location: Steam train (WX1R and WX1L) signs should be located where they are clearly visible to approaching drivers for a distance of at least 120m on rural roads and 60m on urban roads.

Except as shown in figures A9.2, A9.3 and A9.4 and at level crossings where intermediate signs are not required, the steam train WX1R and WX1L) signs should be installed in advance of the level crossings by not less than the distance A in table 4.6 below.

At level crossings where Stop Ahead (WA1), Give Way Ahead (WA2) or other intermediate warning signs are required, steam train (WX1R and WX1L) signs should be installed in advance of the intermediate warning signs by not less than the distance B in table 4.6 below.

Table 4.6 Minimum distances at which signs should be installed

Distance A: in advance of level crossing where no intermediate sign installed

Distance B: in advance of any intermediate sign installed

Road operating speed (km/h)	Distance (m)	
	A	B
50	65	50
70	100	70
100	160	100

4.4.2 Tramway level crossing ahead tram (WX2R and WX2L)



WX2L



WX2R

Policy: The tram (WX2L and WX2R) sign should be used as advance warning of a tramway level crossing on a road ahead.

A tram facing right (WX2L) sign must be installed on the left-hand side of the road on the approaches to a tramway level crossing.

It is recommended that, in addition to the WX2L on the left-hand side of the road, a tram facing left (WX2R) sign is also installed on the right-hand side of the road:

- on roads with an AADT greater than 2000 vehicles per day
- on state highways
- where the tramway level crossing is on a side road and 10-100 metres from the through road (see figures [A9.2](#), [A9.3](#) and [A9.4](#)).

Location: Tram (WX2R and WX2L) signs should be located where they are clearly visible to approaching drivers for a distance of at least 120m on rural roads and 60m on urban roads.

Except as shown in figures [A9.2](#), [A9.3](#) and [A9.4](#), the tram (WX2R and WX2L) signs should be installed in advance of the level crossing by not less than the distance A in [Table 4.6 Minimum distances at which signs should be installed](#).

4.4.3 Exempt (WX11)



Policy: Some vehicles, including passenger service vehicles (other than taxis) and certain dangerous goods vehicles, are required to stop at level crossings that are not equipped with barrier arms or flashing signals.

To allow these vehicles to proceed without stopping, a RCA may, in compliance with clause 9.5 of the TCD Rule, install an Exempt (WX11) sign as a supplementary sign to each level crossing ahead steam train (WX1L or WX1R) installed in advance of the level crossing.

The RCA must be satisfied that:

- rail vehicles are piloted across the level crossing at a speed less than 15km/h
- the level crossing does not have Stop signs installed, and visibility in either direction along the railway line from a point 37m in advance of the limit line is 33m or more
- the road is used by scheduled passenger service vehicles or is on a school bus route
- the rail access provider has approved the exception.

Where the RCA considers an Exempt sign to be justified but all of the conditions listed above are not met, the RCA may apply to the NZTA for approval of an exemption (see section [9.1 Buses and dangerous goods vehicles at level crossings](#)).

4.4.4 Level crossing ahead - type of control

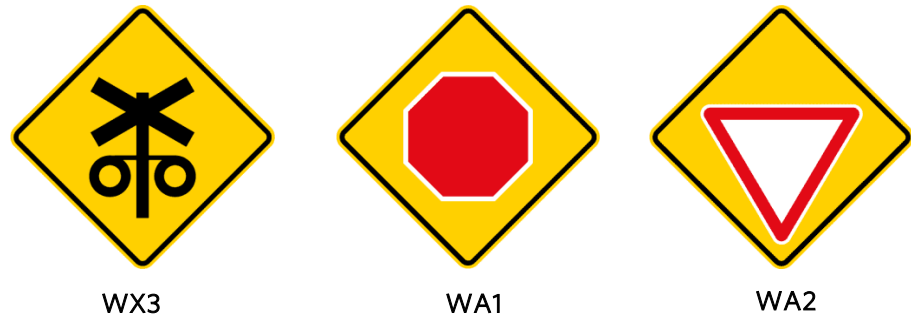

Policy: WX3, WA1 or WA2 signs should be installed on the left-hand side of the road on approaches to level crossings equipped with flashing signals, Stop signs or Give Way signs respectively where the RPX1, RPX2 or RPX3 assemblies are not clearly visible to approaching drivers for a distance of at least 120m on rural roads and at least 60m on urban roads.

The WX3, WA1 or WA2 signs are used with an appropriate supplementary [distance]m ahead (WG3) sign.

On multilane approaches, a second WX3, WA1 or WA2 sign, as appropriate, should be installed on the right-hand side of the road.

Location: WX3, WA1 or WA2 signs should be located where they are clearly visible to approaching drivers over a distance of at least 120m on rural roads and at least 60m on urban roads.

WX3, WA1 or WA2 signs should be installed in advance of level crossings by not less than the distance A shown in [Table 4.6 Minimum distances at which signs should be installed](#).

4.4.5 Low-overhead clearance at electrified railway (RJ2E) assembly

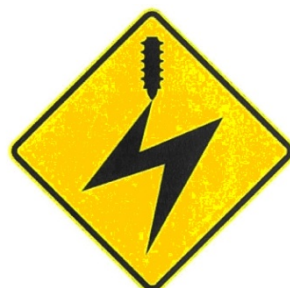

WW41



RJ21 (or RJ22)

RJ2E assembly

Policy: The RJ2E assembly consists of an overhead electrical line (WW41) sign above a height restriction (RJ21 or RJ22) sign. No other sign is to be installed on the same support.

The RJ2E assemblies are installed in advance of level crossings where the presence of overhead electrification lines creates a safe height restriction for road vehicles. Main-line electric lines generally operate at either 1500 V DC or 25 kV AC. The safe height in metres for each specific location is determined by the rail access provider and includes any electrical safety distance to the overhead electric lines.

This height is displayed on the height restriction (RJ21 or RJ22) sign.

Location: An RJ2E assembly should be located on the left side of the carriageway between the level crossing ahead steam train (WX1R or WX1L) signs and the level crossing. There should be an uninterrupted view of the sign over a distance of 120m on rural roads and 60m on urban roads.

Where possible, the RJ2E assembly should be installed in advance of level crossings by not less than the distance A shown in [Table 4.6 Minimum distances at which signs should be installed](#).

Where level crossing on side road (WXR1-WXR5 or WXL1-WXL5) signs are installed, the RJ2E assembly should be located as close as practicable to the intersection on the leg leading to the railway crossing. In this case, or when the approach is multilaned, the signs should be repeated on the right-hand side of the road.

When installing RJ2E assemblies, care must be taken not to obscure any existing signs, signals or level crossing signals.

Sign size: Sign size depends on the particular application, eg urban or rural, two-lane or multilane road. The diameter of the height restriction (RJ21 or RJ22) sign must match the length of each side of the overhead electrical cable (WW41) used.

4.4.6 Level crossing alignment (WX40, WX41 or WX42)



WX40 acute to left



WX41 right angles



WX42 acute to right

Policy: WX40 and WX42 signs should be used when a road crosses a railway line at the appropriately aligned angle (where the angle Z, described in [Figure B1 Approach visibility at passive-controlled level crossings](#), is less than 70 degrees or more than 110 degrees respectively). The sign advises road users of the potential for unexpected changes to the road shape, the possible interaction of the vehicle (particularly a motor cycle or cycle) with the rail and, perhaps of greater relevance, the need for drivers to turn their heads more to enable them to adequately search for on-coming rail vehicles.

Elsewhere the WX41 sign may be used in advance of a level crossing where the RCA considers it would improve awareness of the crossing.

A Look For Trains (WX8) sign may be installed approximately 100mm below a level crossing alignment (WX40, WX41 or WX42) sign.

Location: Level crossing alignment (WX40, WX41 or WX42) signs should be located on the left side of the carriageway between the level crossing ahead steam train (WX1R or WX1L) signs and the level crossing. There should be an uninterrupted view of the sign over a distance of 120m on rural roads and 60m on urban roads.

Where possible, the level crossing alignment (WX40, WX41 or WX42) signs should be installed in advance of level crossings by not less than the distance A shown in [Table 4.6 Minimum distances at which signs should be installed](#).

4.4.7 Level crossings near intersections (WXL1-WXL5, WXR1-WXR5, WXB1 and WXB2)

4.4.7.1 Level crossing near controlled crossroad (WXL1 or WXR1)



WXL1

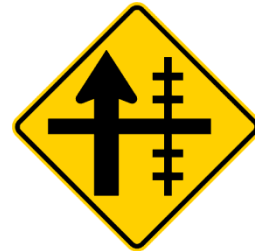

WXR1

4.4.7.2 Level crossing on controlled side road (WXL2 or WXR2)



WXL2



WXR2

4.4.7.3 Level crossing on uncontrolled side road (WXL3 or WXR3)



WXL3



WXR3

4.4.7.4 Level crossing near controlled T-junction level crossing (WXL4 or WXR4)



WXL4



WXR4

4.4.7.5 Level crossing at uncontrolled T-junction level crossing (WXL5 or WXR5)

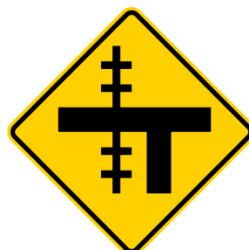

WXL5



WXR5

Policy: The level crossing near intersection (WXL1-WXL5 and WXR1-WXR5) signs apply where a level crossing is located on a road intersecting with the road a driver is travelling on and is near (within 100m) the intersection (see figures A9.1, A9.2, A9.3 and A9.4).

In these situations, the driver may not be intending to travel across the level crossing and it would be inappropriate to use steam train warning signs. However, such a driver still needs to be conscious of the possibility of a vehicle or a queue of vehicles having to stop in his path because of an approaching or passing train. In addition, any driver intending to turn into the road needs advance warning of the presence of the level crossing.

Intersection warning signs indicate the legal priority applying at an intersection. A wider stroke width with an arrowhead represents the roadway with priority, ie the intersecting roadway shown by the narrower stroke width is under Stop or Give Way control. Where normal intersection priority rules apply, both roadways are represented by strokes of equal width without arrowheads. The signs represent the more common situations but, where the intersection layout differs, the sign should be amended by adding an appropriately oriented strip to reflect this.

Location: WXL1-WXL5 and WXR1-WXR5 signs should be located where they are clearly visible to approaching drivers for a distance of at least 120m on rural roads and at least 60m on urban roads and be installed in advance of intersections by at least the distance A shown in Table 4.6 *Minimum distances at which signs should be installed*.

4.4.7.6 Intersection immediately beyond level crossing (WXB1 and WXB2)



WXB1



WXB2

Policy: The intersection beyond level crossing (WXB1 controlled intersection or WXB2 T-junction) signs are only to be considered for use where the distance between the level crossing and the intersection beyond is less than 30m. This distance allows a maximum-sized road vehicle (a vehicle with an overall length of 25m permitted to use the roads without an individual permit but subject to some specific conditions of use) to stop before the intersection and stay clear of the railway line, while anything less provides increasingly more limited space.

In these situations, particularly where the intersection is controlled, it is important to ensure the signs used on the approaches to the level crossing, at the level crossing and at the intersection clearly and unambiguously provide the necessary guidance and direction to drivers.

4.4.8 Short-stacking (WXB3)

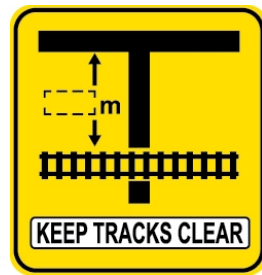

WXB3

Policy: This sign is intended for situations where vehicles longer than the stacking distance encroach on the level crossing when required to stop at the adjacent intersection. The sign should be modified to reflect the intersection layout. It should be installed approximately 20m ahead of the level crossing on the approach side and should be only be used where:

- a WXB1 or WXB2 has been installed and vehicles longer than the stacking length regularly use the crossing, rail speeds exceed 40km/h with more than four trains per day
- there is no scope to provide emergency escape routes for these large vehicles on the departure from the crossing or provision of such mitigation cannot be installed within the short term
- no reasonable alternate route is available for large vehicles and a restriction on vehicle length across the level crossing would not be practicable.



Where an alternate route is available, RJ51 road user restriction heavy vehicle maximum length signs should be installed at the appropriate locations advising that the route across the level crossing is unsuitable for large vehicles of a specified size.

4.4.9 Cyclists take care - railway lines (WX5)



WX5

Policy: In locations where railway lines cross at a skew angle to the direction of travel for cyclists (generally where the angle Z, as described in [Figure B1 Approach visibility at passive-controlled level crossings](#), is less than 60 degrees or more than 120 degrees), it is possible for cyclists' wheels to either slip on wet rails or get lodged in the flangeway of the level crossing. In these situations, the RCA or rail access provider may install the cyclists take care - railway lines (WX5) sign.

A WX5 sign may also be installed where there is a significant number of cyclists travelling parallel to railway lines (most commonly tramway lines). Where a level crossing on a skew is on a significant cycle route the RCA or rail access provider may consider a rubber-filler for the flange gap.

4.4.10 Supplementary [distance]m ahead (WG3)



WG3 (50)



WG3 (100)



WG3 (150)



WG3 (200)

Policy: The [distance]m ahead (WG3) signs are always used in combination with Stop Ahead (WA1) or Give Way Ahead (WA2) and may be used for level crossing ahead flashing signals (WX3) or level crossing alignment (WX40-WX42), PW1-1 and PW1-2 signs.

4.4.11 Active advance warning signs (WX31, WX32 or WX33)

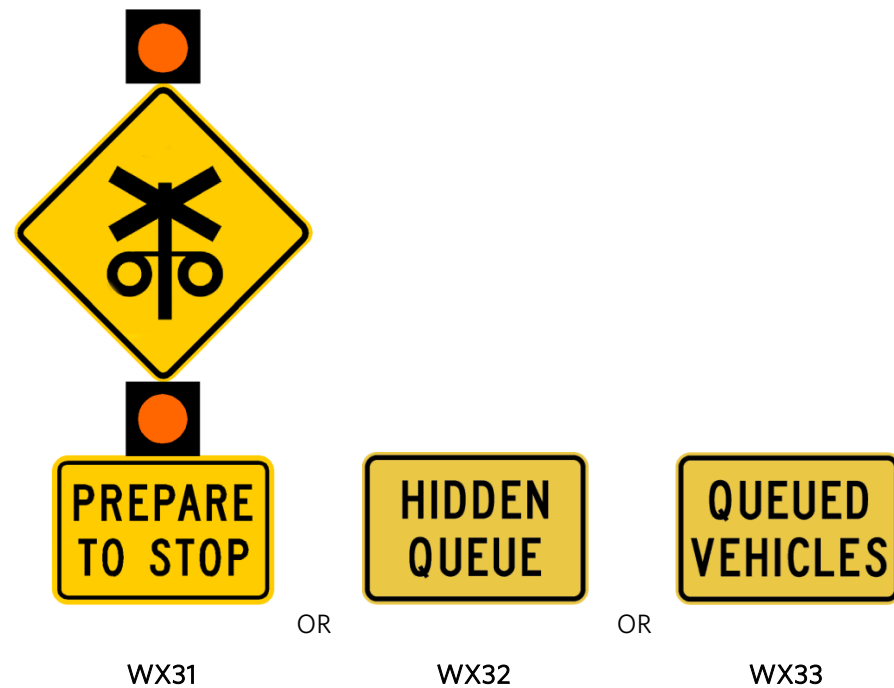

Policy: Active warning signs may be provided in advance of a crossing to supplement railway crossing flashing signals.

The WX32 and WX33 sign assemblies should be used where the assessed risk arises primarily from queues of traffic which, when the level crossing signals operate, extend to a point where approaching vehicles have inadequate advance warning of their presence. In these cases the active advance warning signs should be activated by queue detection rather than on-rail detection systems.

The WX31 sign assembly may be used where a risk assessment indicates an unacceptable train/road user collision risk. At least one of the following conditions would apply:

- The railway crossing is the first encountered after a long distance of unencumbered travel.
- The railway crossing has known history of vehicle crashes of a type which cannot reasonably be alleviated by other warning signs or devices.
- Available driver stopping sight distance to the flashing signals at the railway crossing is below that required for the approach operating speed and cannot be reasonably increased.

Guidance on the location and operational timing for the WX31 assembly can be found in appendix E, Australian Standard AS1742.7-2007 *Manual of uniform traffic control devices*, part 7 Railway crossings.

4.4.12 Active level crossing warning sign



WB1A

Policy: Active warning signs are intended to highlight a particular hazard where the standard signs are ineffective and, in this case, where full railway level crossing flashing signals cannot be justified. The active level crossing warning sign is likely to be most effective where, for example:

- there is an intermittent hazard such as at level crossing on a heritage railway line which only operates for a limited number of days in any month, or
- there are irregular but not infrequent movements of slow moving, shunting trains.

It should be noted that the flashing lights in this sign are yellow and not red and approaching drivers are still obliged to assess whether or not proceed across the level crossing. This allows a reduction in the normal 'fail-to-safe' conditions required of flashing red signals. Detection of trains could therefore be achieved by radar or the signals may be operated manually. The mode of control should only be adopted after a careful risk assessment and appropriate safety systems are in place.

To improve the impact of the sign the symbol should be depicted by LED lamps which are only displayed when the sign is activated

5.0 Road marking

5.1 Standards

Road marking should be provided in accordance with this guideline.

5.2 Responsibilities

As road marking at level crossings is generally outside the rail corridor it will normally be the responsibility of the RCA. Specific exceptions to this apply where the level crossing is a private granted level crossing or a rail operations level crossing where the rail access provider is responsible.

The RCA must liaise with the rail access provider before installing any new road marking in the vicinity of a level crossing.

Road marking contractors must ensure any necessary permit to enter has been obtained for any work that encroaches on the rail corridor (see [Appendix C - Working on or near level crossings](#)).

5.3 Requirements

The following sections outline the specific requirements for road marking around level crossings. Typical situations are illustrated in [Appendix A - Standard sign and marking layouts](#).

5.3.1 Centrelines

Where practicable and the width is greater than 6m, a centreline should be marked on the approaches to level crossings. Centrelines should be marked in the following manner:

- colour - reflectorised white
- width - 100mm
- stripe - continuous
- length - at least 30m on urban roads and at least 50m on rural roads.

Centrelines must terminate at least:

- 2.4m from the nearest rail edge (3m from the centreline of the nearest railway line), and
- 2m from FLB signals and HAB.

Where the length of seal on the approach to a level crossing is not sufficient to accommodate a striped centreline, a continuous centreline must be marked for the full length of the seal.

5.3.2 No-passing lines

a. General

Marked no-passing lines must be placed on all approaches to level crossings, unless the road surface makes it impractical. No-passing lines on approaches to level crossings may need to be extended in situations where sight distance limitations on the road prior to a level crossing also require the application of an overtaking restriction. The visibility requirements of section 2.05 (MOTSAM, part 2 Markings) must be used to determine the extent of no-passing line markings in these cases.

Section 2.05 (MOTSAM, part 2 Markings) should also be used to determine where traffic travelling in the opposite direction should also have an overtaking restriction applied.

Overtaking restrictions on the approaches to level crossings must be marked in the following manner.

- No-passing lines:
 - o colour - reflectorised yellow
 - o width - 100mm, offset 100mm from a centreline marking or another overtaking line
 - o stripe - continuous
 - o length - varies - see (b), (c) and (d) below.
- No-passing advance warning lines (should be marked in advance of all overtaking restrictions):
 - o colour - reflectorised yellow
 - o width - 100mm, offset 100mm from a centreline marking or another overtaking line
 - o stripe - 13m (three stripes) on urban roads, and 13m (five stripes) on rural roads
 - o gap - 7m
 - o the lines must commence 60m in advance of no-passing lines marked on urban roads, and 100m in advance of no-passing lines marked on rural roads.

b. Approaches to level crossings *without* intermediate warning signs

A continuous no-passing line must be marked from the level crossing ahead steam train (WX1L or WX1R) warning signs to the limit line at the level crossing (see figures [A2](#), [A4](#) and [A6](#) for examples). No-passing advance warning lines must be marked in advance of the continuous no-passing line.

c. Approaches to level crossings *with* intermediate warning signs

A continuous no-passing line must be marked from the intermediate warning sign (ie level crossing alignment (WX40, WX41 or WX42) or advance warning type of control signs (WA1, WA2 or WX3)) to the limit line at the level crossing (see figures [A3](#), [A5](#), [A7](#), [A8](#) and [A10](#) for examples). No-passing advance warning lines must be marked in advance of the continuous no-passing line.

d. Approaches to level crossings on side roads

Where a level crossing is located on a side road less than the appropriate level crossing ahead steam train (WX1L or WX1R) warning sign distance from a main road intersection, a no-passing line should be marked from the main road intersection to the limit line at the level crossing (see figures [A9.1-A9.4](#)).

5.3.3 Flush medians

Flush medians on the approaches to level crossings can assist in channelling traffic across the railway line.

The edge of a flush median is legally a no passing line and therefore no passing lines are not necessary and should not be marked.

Drivers are able to use the flush median where they are turning right and when they do this they may overtake queued vehicles in the normal lane. As undesirable overtaking over the level crossing may occur, a flush median where there is right turning in close proximity to the level crossing is not recommended unless some form of physical barrier can be installed to prevent the overtaking.

The barrier may take the form of a raised island or centre-of-road flexible delineators.

5.3.4 Limit lines

a. General

Limit lines must be marked on all sealed approaches to level crossings to indicate the safe positions for vehicles to stop, if necessary, to avoid conflict with trains.

Limit lines must be marked at right angles to the approach road centrelines, unless site constraints make this impractical, and every part of the line must be at least:

- 2.4m from the nearest rail edge (3m from the centreline of the nearest railway line), and
- 2m in advance of an FLB or a lowered HAB.

Limit lines should normally be installed at the minimum permitted clearance from the railway line to ensure drivers are encouraged to stop where adequate restart views are available and to minimise the time for vehicles to clear the railway after stopping.

Full details of limit lines can be found in the section 3.06, MOTSAM, part 2 Markings.

b. Limit lines for level crossings controlled by Stop signs

Limit lines at level crossings controlled by Stop signs (RP1) must be marked in the following manner:

- colour - reflectorised yellow
- width - one 200mm wide line on urban roads, and one 300mm wide line on rural roads
- stripe - continuous.

c. Limit lines for all other forms of level crossing control

Limit lines for all other forms of level crossing control must be marked in the following manner:

- colour - reflectorised white
 - width - one 200mm wide line on urban roads, and one 300mm wide line on rural roads
 - stripe - continuous.
-

5.3.5 Pavement messages

a. General

Any symbols, lettering used for pavement messages or other markings on sealed approaches to level crossings and at the level crossings must conform to the dimensions and form specified in the TCD Rule.

Pavement messages must be marked in the following manner:

- colour - reflectorised white
- letter height - 2.4m on urban roads and 3.6m on rural roads.

b. Give way marking

The TCD Rule requires either a Give Way triangle for new markings or the word 'give' followed by 'way' to be marked on the road surface of all sealed approaches to level crossings controlled by Give Way (RP2) signs. The triangle or the word 'way' must be marked approximately 10m from the limit line.

c. Stop marking

Where practicable, the word 'stop' must be marked on the road surfaces of all sealed approaches to level crossings controlled by R2-1 Stop signs (see TCD Rule).

The word 'stop' must be marked approximately 10m from the limit line.

d. Rail X marking

Where practicable, the TCD Rule requires the word 'rail' followed by the symbol 'X' to be marked on the road surface of all:

- approaches to level crossings where the posted speed limit is 70km/h or higher
- multilane approaches to level crossings.

The size and format of the 'X' and 'rail' are shown in figure [A11](#).

Approaches to level crossings *without* intermediate warning signs must have the symbol 'X' marked approximately 10m in advance of the level crossing ahead steam train (WX1L or WX1R) warning signs to the limit line at the level crossing (see figures [A2](#), [A4](#) and [A6](#) for examples).

The word 'rail' is to be marked approximately:

- 15m in advance of the symbol 'X' on urban roads
- 25m in advance of the symbol 'X' on rural roads.

Approaches to level crossings *with* intermediate warning signs must have the word 'rail' marked approximately 15m beyond the intermediate warning sign (ie level crossing alignment (WX40, WX41 or WX41) or advance warning - type of control signs (WA1, WA2 or WX3)) to the limit line at the level crossing (see figures [A3](#), [A5](#), [A7](#), [A8](#) and [A10](#) for examples).

The symbol 'X' is to be marked approximately:

- 15m beyond the word 'rail' on urban roads
- 25m beyond the word 'rail' on rural roads.

The 'rail X' marking may also be used on the approach to any level crossing the RCA considers necessary because of high approach speeds, restricted visibility, environment problems such as sun or fog.

5.3.6 No-stopping lines

On urban roads, no-stopping lines should be marked on the approaches to level crossings in the following manner:

- colour - reflectorised yellow
- width - 100mm
- stripe - 1m
- gap - 1m
- length - 20m minimum.

The length of a no-stopping restriction may need to be extended on the approaches to some level crossings, to ensure signs and control devices are visible from a safe stopping distance.

In rural areas, no-stopping lines may also be marked on the approaches to level crossings when the RCA considers vehicles could park and restrict the visibility of signs and control devices from a safe stopping distance.

Refer to [Appendix B - Sight distances at level crossings](#) for safe stopping distances and visibility criteria at passive control level crossings (ie crossings with a stop or give way sign).

5.3.7 Cross hatching (clear zones)

Where the departure of long vehicles or queues of traffic from a level crossing may be blocked by a nearby intersection or other traffic control device, an escape lane or clear zone should be provided.

Cross-hatch markings may be used to define a clear zone area that drivers should not enter when their departure from a level crossing is blocked.

Cross-hatched clear zones should be marked in the following manner:

- colour - reflectorised yellow
- cross-hatch line - 100mm wide
- border line - 100mm wide
- should not, on any lane, extend beyond 2.4m from the nearest rail edge (3m from the centreline of the nearest railway line).

For layout see figure [A12](#).

5.3.8 Emergency-escape zones

Emergency-escape zones, described in section [7.7 Level crossing in close proximity to an intersection](#), utilise cross hatching.

6.0 Control devices

6.1 Introduction

There are a number of different types of control devices that may be used at level crossings in accordance with these guidelines. The type selected will depend on the characteristics of the level crossing being controlled. (Refer to section [3.0 Risk assessment and ALCAM](#).) The standard approved control devices are described below.

6.2 Types of controls

6.2.1 Active

Active control of vehicular and/or pedestrian traffic at a level crossing uses flashing lights, bells, barrier arms, gates or a combination of these devices. Control devices of this nature are activated by the approaching railway traffic automatically or manually. These types of control devices are explained in detail in section [6.4 Traffic signal integration with level crossing](#).

6.2.2 Passive

Passive control of vehicular and/or pedestrian traffic is achieved by the provision of signs not activated by an approaching train. Their purpose is to indicate to the road user or pedestrian that it is their responsibility to check for the approach of trains prior to crossing the railway lines.

Passive control on roads is achieved through the installation of Stop (RP1) or Give Way (RP2) signs (see section [4.3 Signs used at level crossings](#) and [Appendix B - Sight distances at level crossings](#)).

At pedestrian-only level crossings, the Look For Trains (WX8) sign should be provided.

At private, gated level crossings, a sign should be provided that advises users of the crossing procedures, eg contact train control before moving stock across the railway line.

6.3 Railway-activated control devices

Railway-activated control devices at level crossings are described below. These control devices are activated through signalling circuits upon the approach of a train to a level crossing. The activation of these circuits has three basic mechanisms - distance, predictor and manual.

The majority are set to operate a predetermined distance along the railway to give a minimum alarm warning time period before a train operating at the fastest speed permitted reaches the level crossing. In some instances, the warning time may be increased further by multiple railway lines or nearby stations. When HABs are installed, the barriers may be held down for a second train if there would not be sufficient time for the barriers to rise and fall again before the second train would reach the level crossing.

Where stations are located near level crossings, additional equipment may be installed to adjust the warning time to account for a stopping or non-stopping train.

Predictor mechanisms operate control devices by determining the approaching train speed and adjusting the activation of the level crossing so that the length of time between activation and the train reaching the level crossing is constant for all train speeds.

Use of road traffic signals as level crossing control devices may be considered only where:

- the level crossing is extremely close to an existing road intersection that must be controlled by traffic signals
- the maximum rail speed is 15km/h and it is feasible for rail movements to be stopped before crossing the road
- the installation of standard FLB controls is not feasible due to:
 - space constraints
 - insufficient railway traffic to justify the installation of FLBs.

In these cases, the rail movement cedes the right of way. The approach of a train or operation of a manual signalling device by a rail participant initiates a rail phase. The rail movement may not proceed until the appropriate T-aspect is displayed. Sufficient WX6 signs should be mounted on traffic signal poles so that a sign is clearly visible to drivers from all road approach directions.

The automatic alarms at a manually controlled crossing are started by the rail operator before the train crosses the road. In such cases, the rail speed will normally be no greater than 25km/h so the train can, if necessary, be stopped before crossing the road. There will be no fixed time between the start of the alarms and the train entering the crossing but the rail operator would normally wait until any approaching road traffic has stopped before proceeding.

Where there is a high degree of pedestrian and commuter train traffic on two or more railway lines, additional warning devices may be installed. These may include a secondary audible alarm of a different volume and frequency to the standard level crossing alarms. In addition, an electronic sign warning of a second train coming may be installed for pedestrians.

6.3.1 Flashing lights and bells (FLBs)

An FLB consists of two red traffic signals mounted horizontally on a red and white striped pole. The pole may also support traffic signs (see section 4.3 [Signs used at level crossings](#)) and a warning bell, which is intended to alert pedestrians and cyclists to the impending passage of a train. The assembly can be used by itself on the left side of the carriageway, or may be duplicated or triplicated for multiple-approach angles, multiple-traffic lanes or high-traffic volumes (with a potential for overtaking).

When activated, the lights flash alternately and the warning bells ring. When flashing, this signal indicates that drivers must stop before entering the controlled area of the level crossing (defined by the limit lines) and remain stationary during the flashing period.

In some urban situations, the bells (primarily intended as a warning to pedestrian and cycle traffic) may not be activated during normal sleeping hours. In these circumstances, a Bells Off (AX11) sign, described in section 4.3 [Signs used at level crossings](#), must be installed and the sign must indicate the times during which the bells will be switched off.

At level crossings where HABs (refer to section 6.4 [Traffic signal integration with level crossing](#)) are installed, bells will always operate until the barrier arms reach the lowered position.

Pedestrian level crossings may be solely protected by bells mounted on a pole. In these cases, a Look For Trains (WX8) sign must be placed on the signal pole facing approaching pedestrians and the railway lines must be clearly visible in each direction.

6.3.2 Half-arm barriers (HABs)

In some situations, HABs are used in conjunction with FLB controls.

Barriers are lowered a minimum period (usually five seconds) after the lights and bells have been activated. Vehicles on the level crossing can exit the level crossing control area because the barriers obstruct only half the carriageway. Barriers are intended to enforce compliance with flashing lights and reinforce the warning system by providing a physical boundary to access on to the railway.

6.3.3 Pedestrian gates

Where pedestrian and train movements are high, automatically activated pedestrian gates may be justified. These provide positive control of pedestrian movements and also provide good levels of pedestrian (and cycle) service across the railway line(s) when the gates are open.

6.3.4 Active signs

Active level crossing warning signs are intended for use where full railway level crossing flashing signals cannot be justified. The sign, a WB1A is described in section 4.4 [Signs used in advance of level crossings](#).

6.4 Traffic signal integration with level crossing

Where an intersection controlled by traffic signals is near a level crossing (not necessarily actively controlled), integration of the railway signalling circuits to force phases in the traffic signals may be used and is particularly appropriate where limited stacking space is available for vehicles at the level crossing. This integration between the intersection signals and those at the level crossing require specialised planning and input from the rail access provider.

Normally integration will be required where the signal controlled intersection is within 30m of the level crossing and should be considered where this distance is up to 60m.

6.5 Locomotive-mounted warning devices

The operation of locomotive horns, whistles or similar is required in some circumstances and is optional in others. The requirements for trains to sound these warning devices are governed by the operating rules of the rail access provider.

In circumstances where a locomotive engineer's visibility of an approaching level crossing is poor, the rail access provider may provide whistle boards requiring the sounding of a warning device. At other level crossings, the operation of the warning device is at the judgement of the locomotive engineer. This degree of flexibility allows, for instance, locomotive engineers on trains operating late at night through residential areas the discretion to minimise disturbance by not sounding a warning device more than necessary.

6.6 Rail vehicles yielding to road traffic

Where there is a need for rail vehicles to yield to road traffic, the RCA and rail access provider must agree on the most appropriate arrangement to provide the safety environment at the level crossing.

7.0 Road geometry, surfacing and lighting

7.1 Introduction

The construction of level crossings requires the matching of road and rail levels into the final design. In some instances, this may be difficult, eg when multiple curved railway lines pass through a level crossing. For any proposed change in the existing road and/or rail geometry at a level crossing, the specific design requirements of the rail access provider must be incorporated into geometry and surfacing requirements. Where these are currently deficient, they should be reviewed as part of any road work projects adjacent to the level crossing.

It is especially important for road and rail authorities to work together when resurfacing or reviewing the geometry of a level crossing. Treating the road either side of the 5m boundary in isolation can result in sharp changes in gradient that may cause long vehicles to become stuck on the level crossing panel. A lower level of risk, reduced maintenance costs and better drainage can be achieved through proper design and coordination of road surfacing works with the rail access provider.

7.2 Responsibility

The rail access provider is responsible for the formation and maintenance of the road surface 5m either side from the centreline of the railway line.

Where KiwiRail is the rail access provider, it will also construct or reconstruct level crossings in accordance with its standards. Other rail access providers may have specific requirements.

The RCA is responsible for the formation and maintenance of the road surface beyond 5m and all associated pavement marking related to the level crossing regardless of the 5m distance.

7.3 Standard construction requirements for level crossings

KiwiRail has developed geometric standards that it applies as appropriate to different types of level crossings, traffic levels and volumes. Other access providers may also have standards of their own. Non-specific geometric and operational standards around the rail lines include the following:

- The pavement must be sloped away from rail at a minimum of one in 50 for at least 5m either side from centreline of the railway line.
- Surface water from the adjacent roadways must not be allowed to run onto the railway lines. All runoff must be collected prior to the level crossing.
- New or reconstructed level crossings require significant disturbance and, due to high train axle loadings, require time to settle after initial construction. Level crossings generally will not be sealed the day of construction for this reason.
- Chip seal is acceptable only as a temporary surface while a highly-trafficked level crossing is being allowed to settle.
- Where retained asphalt or timber are utilised, the timber members must be installed 10mm above the top of the rail to protect it from impacts from heavy axle vehicles.
- Where pedestrian mazes are provided as part of a new or existing level crossing, the specific geometry requirements noted in section [8.0 Requirements for pedestrian and cycle level crossings](#) should be followed. Exceptions due to property restraint or other reasons will require rail access provider approval.

Alternative level crossing material to asphalt or timber complying with rail access provider standards may be used, eg rubber slabs, subject to the approval of the rail access provider and RCA.

7.4 Seal requirements

It is desirable that level crossings with more than 50 road vehicles per day have a minimum of 6m width of seal installed for 30m on each level crossing approach to allow the marking of limit lines. See figure [A1](#).

Level crossings with more than 100 road vehicles per day should desirably have a minimum of 6m width of seal for the length of carriageway necessary to accommodate the marking of a full length of the solid no-passing line on each approach in accordance with figures [A2–A10](#) in appendix A (ie 65–180m).

Asphalt surfacing or appropriate alternatives should be provided, except when the level crossing is settling after construction where a temporary chip seal coat may be used. Any seal design and application must meet the requirements of the RCA.

7.5 Alignment

The approaches to level crossings should not include any substantial geometric features (curves, crests or intersections). Any reconstructive or corrective work near a level crossing should be designed to make it as straightforward as possible for approaching motorists. Where the angle between the road and rail is less than 85 degrees or more than 110 degrees, it can be extremely difficult for a driver, particularly of a truck, to get a clear view in both directions along the railway line.

In some situations, particularly at level crossings with passive controls, it may be more appropriate to sacrifice the design speed of an approach curve to accommodate a longer straight, or transition spiral, between it and the level crossing.

For uphill steep road approaches either side of a railway line, the risks of long vehicles grounding on the railway lines should be assessed and, if necessary, long road vehicle restrictions applied.

7.6 Traffic islands

It is desirable for all multilane approaches to level crossings to have a central, raised island. In many cases, the island enables the installation of duplicate traffic control devices including, where equipped, flashing lights, bells and barriers. It also creates a physical barrier for any attempts to overtake vehicles.

Where the width of roadway does not permit a minimum sized island consideration should be given to the installation of centre-of-road flexible delineators.

Islands or centre-of-road flexible delineators should be considered elsewhere when there is clear evidence of risky or significant numbers of overtaking movements.

7.7 Level crossing in close proximity to an intersection

7.7.1 Short stacking

The term 'short stacking' refers to locations where an existing level crossing is in close proximity to an intersection and a vehicle, particularly a maximum-sized heavy motor vehicle (20–25m long), could block the level crossing or intersection when departing from either. Where there is short stacking, consideration should be given to providing:

- a. auxiliary road space (slip lanes or shoulder widening) to allow a vehicle to escape or wait clear of the railway line or road traffic
- b. where an alternative route exists, partial closure (to vehicles over a defined length) or complete closure
- c. channelisation, realignment or relocation of the road
- d. realignment of the railway line
- e. active control of the level crossing and intersection.

Where queues of traffic block the level crossing, options (c) and (e) would be indicated. If the intersection and level crossing are signalised, the intersection signals and railway signal circuits should be linked.

7.7.2 Queues

Where an actively controlled level crossing is regularly encroached by queues of vehicles from a nearby, generally signalised, intersection consideration should be given to:

- a. integration of the railway signalling circuits to force phases in the traffic signals
- b. where the level crossing is a distance from the intersection which would not allow queue clearance without excessive advance train detection (and therefore untenable traffic signal phase timings), normal traffic signals at the level crossing with queue detectors on the critical departure side.

Note: This concept is not permitted under current rules and is being considered for formal trial. See [6.5 Locomotive-mounted warning devices](#)

- c. emergency-escape zones on the departure side.

Emergency-escape zones are bays installed on the left or right hand side of the road where a vehicle 'caught' in a queue and over the railway lines can, when the bells and signals start operating, move forward into the bay to enable them to clear the railway line.

These bays should be designed in such a way that they will only be used for the purpose intended. This generally means that exiting from the bay does not mean the driver can simply drive forward but is required to filter back into the queue of vehicles in the adjacent lane. To achieve this, the design would normally provide for no more than two cars or a single unit truck and have a physical island with non-mountable kerbing terminating the bay (see figure [A13](#)).

7.8 Level crossing in close proximity to a driveway

Driveways that are close to level crossings can create problems for drivers moving into or out of the driveway across the level crossing and can introduce difficulties for the rail access provider and RCA in relation to the placement and alignment of traffic control devices.

Drivers turning into the driveway could block, or cause the blockage, of the level crossing.

Drivers turning out of driveways, particularly heavy truck drivers, may have insufficient room to align their vehicle at the level crossing to enable them to see along the railway lines for any approaching train. Their attempt to gain access to the roadway may distract them from also assessing the presence of a train.

The angle at which drivers are able to enter or leave a driveway may lead, eg to barrier arms being incorrectly aligned to stop them from crossing the railway line or, to avoid this, there may be less than optimum alignment for the main road users. Additional warning signs or flashing light assemblies may be required.

It is recommended that driveways should not be located closer than 30m to a level crossing. Greater distances are desirable where there is likely to be large vehicles regularly entering the site and would be essential where the driveway leads to a significant traffic generator (eg shopping centre, service station).

7.9 Lighting

The safety of controlled level crossings at night typically relies on the driver of a motor vehicle identifying the flashing red signals, bells and/or barrier arm at the level crossing. At passive level crossings, the headlight of the approaching train provides the cue to the driver to stop. None of these features used by motorists is significantly enhanced by the provision of road lighting and, for that reason, road lighting is not a requirement for a level crossing.

However, road lighting may sometimes help bring to the attention of drivers the presence of a level crossing that may otherwise have been missed. In particular, section 3.5.2(b)(ii) of the road lighting Australian and New Zealand Standard AS/NZS 1158.1.1:2005 *Main street lighting: Lighting for road and public spaces, part 1.1 Vehicular traffic (category V) lighting: Performance and design requirements* refers to a method of lighting known as flag lighting, where an intersection is highlighted by the provision of one or two strategically placed luminaries. This technique may be applied at some level crossings and would likely lead to a luminary being placed on each approach to the level crossing within 20m of the level crossing.

At level crossings where a specific night-time safety problem has been identified, road lighting may form part of the mix of measures designed to overcome identified deficiencies. Care would need to be taken to ensure that glare was tightly controlled and that the presence of the lighting did not itself impede other visual tasks.

8.0 Requirements for pedestrian and cycle level crossings

8.1 Introduction

The mitigation of risk is paramount for pedestrian and cycle level crossings. An ALCAM assessment will enable these risks to be identified but the local experience of the rail access provider and RCA will also need to be included in the safety assessment.

8.2 Pedestrian level crossings

At locations where pedestrians can legally cross a railway line at grade, the facilities to be provided at individual level crossings will vary, depending on the configuration of the public road and pedestrian footway on the approaches and the position of the footway in relation to the road. Where a standard pedestrian maze cannot be accommodated, then the design of the pedestrian section of the level crossing must be such that the pedestrian is directed to face towards the oncoming direction of the train travel immediately prior to crossing the railway lines wherever possible.

Where an informal pathway crosses a railway line (ie a non-granted or non-statutory level crossing), steps should be taken to:

- install a fence or other barrier to prevent use of the crossing, or
 - formalise the crossing and provide appropriate pedestrian facilities.
-

8.2.1 Provision for pedestrians at public road level crossings

Where a footway is provided on the approach to the level crossing, it should continue across the railway line as a marked or well-defined footway. Where practicable, one white limit line should be provided across the footway at a distance of not less than 2.4m from the nearest rail edge. In addition, immediately behind the white line, a set of tactile ground surface indicators (TGSIs) as described in RTS14 must be placed in accordance with current standards to indicate a safe position for pedestrians to wait for the passage of trains. Look For Trains (WX8) warning signs and fencing to direct pedestrians to the level crossing may also be considered (see section [8.5 Pedestrian mazes](#)).

8.2.2 Stand-alone pedestrian level crossings

A stand-alone pedestrian level crossing is one provided for crossing the railway line(s) and is not included within a road corridor.

Pedestrians should be provided with a marked or well-defined footway, with fencing along the pedestrian approaches to the level crossing, to direct them to, and clearly define, the level crossing. Look For Trains (WX8) signs to warn or direct should be provided. Where practicable, one white limit line should be provided across the footway at a distance of 2.4m (and no less than 1.9m) from the nearest rail edge. In addition, immediately behind the white line, a set of TGS1 as described in RTS14 should be placed in accordance with current standards to indicate a safe position for pedestrians to wait for the passage of trains.

Where practicable, all pedestrian facilities should be located and constructed to provide pedestrians with the best clear visibility in both directions along the railway line from a position not less than 2.4m away from the nearest rail edge. This distance is equivalent to six seconds for a single railway line and 10 seconds for a double railway line of walking time based on a walking speed of 1m/sec for the pedestrian to cross and safely clear the railway lines.

8.2.3 Additional facilities

The following items may be considered for improving pedestrian level crossings, taking value for money and ALCAM assessments into account:

- pedestrian mazes or barriers to ensure pedestrians make at least one 180-degree turn before crossing the railway lines. At multiple railway lines, the maze should orientate pedestrians so they face oncoming trains before crossing the railway lines (refer to section 8.5 Pedestrian mazes)
- active control and indication, including audible signals (bells), flashing lights, train coming indication lights, do not cross lights, barrier arms, gates
- night-time illumination of the level crossing.

The decision to provide additional facilities at specific locations should be made after an analysis of the hazards presented at each site, in accordance with the ALCAM procedures.

For new installations, this assessment will determine the appropriate level of protection to be provided at the time of the installation.

For existing sites, the assessment should be the basis of a priority list for the upgrading of levels of protection at individual level crossings, where the appropriate requirements for a new level crossing at the same location are not met.

Sites thus identified should be provided with the protection appropriate to the identified risk, subject to a benefit-cost analysis taking account of 'reasonable cost' criteria.

Additional facilities for pedestrian level crossings may be more easily justified when provided in conjunction with an adjacent roadway, or where lines of clear sight are so restricted that pedestrians would have insufficient time to safely cross the railway line or lines before the arrival of a previously unseen train.

8.3 Cycle facilities

Where a cycleway crosses a railway line at grade and separate from a vehicle carriageway, speed control barriers and signs to warn or direct cyclists must be provided. Where there are multiple railway lines, the barriers should orientate cyclists so they face oncoming trains.

Additionally, consideration can be given to providing the following:

- fencing on the cycle approaches to direct cyclists and define the level crossing
- audible signals (bells), flashing lights, train coming indication lights, do not cross lights, barrier arms
- night-time illumination of the level crossing.

As for pedestrian level crossings, the decision on the provision of additional facilities at specific locations should be made after an analysis and assessment of the hazards presented at each site and a formal risk analysis.

Special facilities for a cycleway may be more readily justified when provided in conjunction with an adjacent roadway, or where lines of clear sight are so restricted that cyclists would have insufficient time to safely cross the railway line before the arrival of a previously unseen train.

8.4 Footway and cycleway construction

Paths and cycleways approaching the level crossing must be constructed in suitable materials, such as asphalt, chip seal, concrete or compacted aggregate. The level crossings themselves must be in accordance with the rail access provider standard plans. These level crossings may comprise precast concrete insert panels, timber panels, full-depth asphaltic concrete with edge supports either side of each rail or rubber mat inserts.

Where a cycleway crosses the railway line at an acute skew angle, cyclists may experience wheels slipping on the rail or falling into the flangeway. In these situations, the installation of a Cyclists Take Care (WX5) sign may be considered. Wherever possible, footway and cycleway level crossings should be constructed at right angles to the railway line.

8.5 Pedestrian mazes

Where a level crossing is located in a high-traffic area or where it crosses two or more railway lines, a pedestrian maze should be provided (see [Figure 8.1 Typical pedestrian maze for level crossings](#) for a typical design). Maze fencing should be installed to ensure that pedestrians are directed to turn towards the direction of any approaching train. Mazes are designed to cater for wheelchairs and mobility devices.

Figure 8.1 Typical pedestrian maze for level crossings

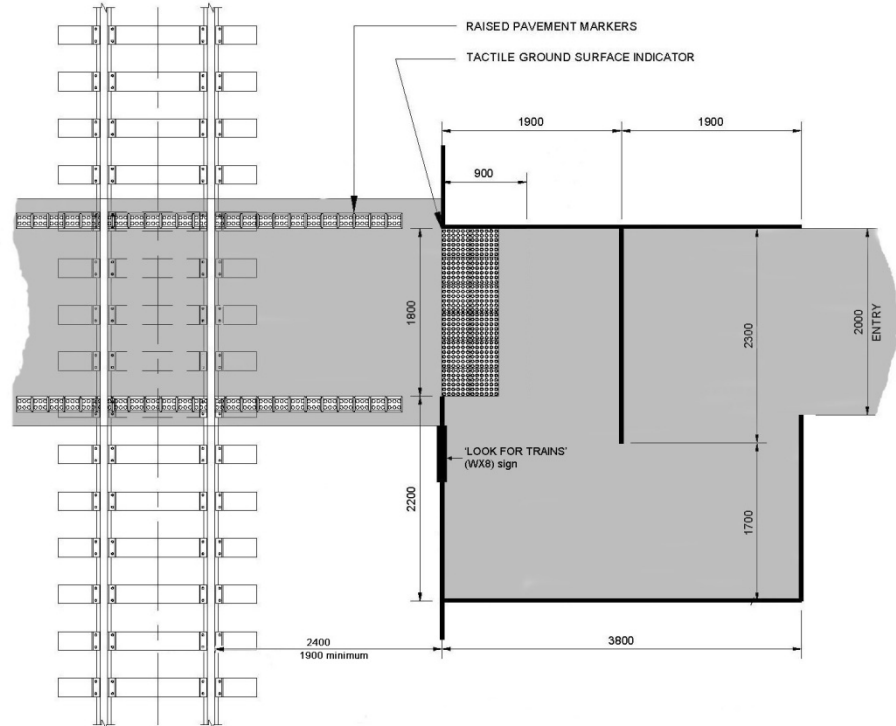

Maze fencing is not appropriate when:

- site dimensions do not allow sufficient space to construct a maze
- it is not practical to install sufficient fencing to encourage most pedestrians to use the maze, eg adjacent to a station platform
- peak pedestrian traffic flows regularly exceed the capacity of a 2m wide footway so that the maze may form an obstruction to persons wishing to clear the railway line or lines.

8.6 Active protection

Active protection for pedestrians, particularly at isolated pedestrian level crossings, may be justified.

The types of protection include:

- bells plus flashing lights or flashing indicators
- second train coming illuminated signs
- automatic pedestrian gates.

The level of protection is largely determined by the pedestrian (and cycle) demand and the frequency of train use.

9.0 Requirements for specific road vehicles

9.1 Buses and dangerous goods vehicles at level crossings

Large passenger service vehicles, school buses and certain dangerous goods vehicles¹ are required to stop at a level crossing unless the crossing has flashing signals (with or without barrier arms) installed or an Exempt (WX11) sign is installed in advance of the crossing (see section 4.4 *Signs used in advance of level crossings*).

The TCD Rule largely confers the power to install Exempt (WX11) signs to RCAs providing the conditions of subclause 9.5(1) are met. Where subclause 9.5(1) does not fully apply and the RCA considers there should be an exception, the approval of the NZTA may be sought in terms of subclause 9.5(2).

Applications seeking an exception should be directed to the appropriate regional office of the NZTA. The application should include:

- grounds for seeking the exception
 - details of the operation of the level crossing in line with the criteria in subclause 9.5(1)
 - views of the RCA and rail access provider.
-

9.2 Overweight and over-dimension road loads

A level crossing can be an obstacle for a road load due to overhead, side or ground clearances. These large and heavy loads can also be slow moving, which increases the potential for conflict with rail movements at level crossings.

For this reason, there are procedures in place to safely handle these types of loads and to minimise potential conflicts with train movements, railway overhead services and equipment. These types of loads will generally require the issue of a permit that authorises the movement and stipulates any specific requirements needed for the movement to take place.

On over-dimensional vehicle routes, 11.5m clearance between roadside obstructions is generally provided and overhead obstructions (including lighting) avoided. In locations where this is not possible demountable signs and equipment should be considered.

In the movement of some loads, supervision or temporary relocation of equipment by the access provider may be required. Where this is the case, costs are recoverable from the vehicle operator.

¹The list of dangerous goods includes:

- Class 1 (explosives) with some exceptions, or
- Class 2.1 (flammable gases) or Class 3 (flammable liquids) in quantities of 250 litres or more or where they are transported in a tank-wagon, portable tank or containers for bulk quantities of dangerous goods.

9.2.1 Overweight loads

The movement of heavy loads over a railway line has the potential to permanently damage the railway line and its structure. The movement of these overweight loads over road, bridges and level crossings is administered by the RCA. Procedures involved are laid down in the NZTA's *Overweight permit manual*.

9.2.2 Over-dimension loads

The use of roads by over-sized loads is governed by the Land Transport Rule: Vehicle Dimensions and Mass 2002. Some loads require written permits prior to travel. Where such loads must cross-level crossings, the operator will be required to contact the rail access provider to gain approval to use these level crossings.

The rail access provider will determine whether a permit is required for the specific level crossings involved. If the movement across the level crossings is approved, any permit issued will define the special conditions for each level crossing required due to the size or type of the load.

10.0 Requirements for private level crossings

KiwiRail is undertaking a review of private level crossings. It is expected the review will result in a more detailed policy for private level crossings. The New Zealand Level Crossing Working group will consider the review and if appropriate include the policies in this document.

10.1 Introduction

The rail access provider has the power to install signs and markings at private level crossings. These should be provided in accordance with these guidelines.

10.2 Private property access level crossings

10.2.1 View lines

Standard approach visibility and restart view are to be provided. The criteria described in section 4.3 [Signs used at level crossings](#) apply.

10.2.2 Signs

The rail access provider is responsible for the provision of signs at private level crossings if there is an agreement on funding with the crossing user or users. An issued deed of grant for the level crossing will normally place the responsibility for sign installation and maintenance with the grantee.

The signs installed at non-gated approaches to private level crossings are at least a crossbuck for private level crossings (WX62 or WX63) or preferably a private level crossing Stop (RPX4) or private level crossing Give Way (RPX5) assembly as appropriate. If necessary, a standard level crossing Stop (RPX2) or standard level crossing Give Way (RPX3) assembly may be used.

If the general public is invited to use a private level crossing (eg to gain access to an advertised business or where the original single ownership use has intensified through change of land use), the signs for public roads (RPX2 or RPX3) will generally apply, unless a formal process of a risk assessment determines otherwise.

10.2.3 Markings

Where the surface of a private property access level crossing is sealed, the markings are to be the same as for public level crossings on surfaced roads.

Figure 10.1 General layout of signs and markings for unsealed private property access level crossings

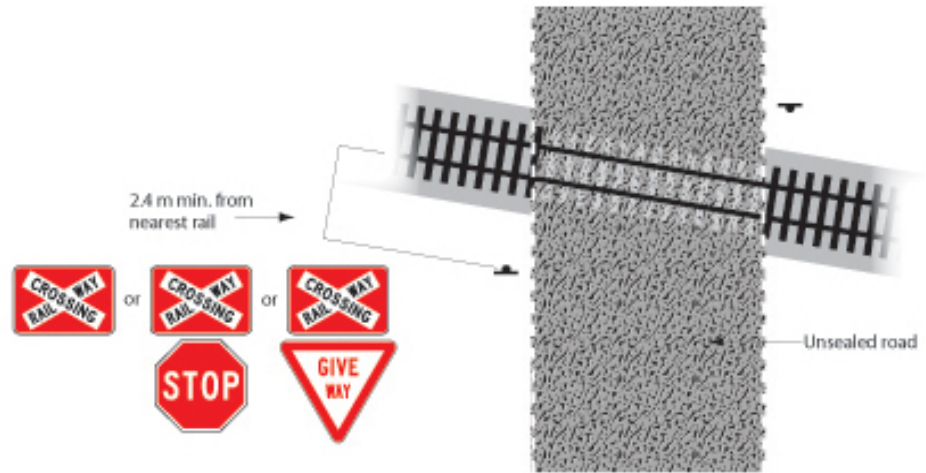

10.2.4 Active devices

Active devices may be installed by the rail access provider or grantee of a level crossing. The requirements must be determined with the appropriate rail access provider.

11.0 Requirements for rail operations level crossings

11.1 Introduction

Rail operations level crossings are located on railway property and are used in the operation of railway business. They are generally, because of their limited use, level crossings with passive control. Rail operations level crossings can be defined in two categories where the:

1. level crossings purely in use for the operation of the railway. These are rail access level crossings
 2. level crossings typically providing access to rail access providers' or rail operators' facilities (eg marshalling yards, depot, workshops where railway lines and level crossings are present). These are public access level crossings.
-

11.2 Rail access level crossings

Rail access level crossings are not available for use by the public and are used only by a rail access provider or rail operator vehicles. Contractors working on the rail corridor may also have access to these level crossings. All of these parties are present on the rail corridor with appropriate training and certification, in accordance with the rail access provider requirements.

Where relevant, low-overhead clearance – electrified railway (RJ2E) signs should be installed.

11.3 Public access level crossings

Public access level crossings may be accessed by the general public, couriers, suppliers and others not generally certified to work within or access the rail property.

Signs and markings for these types of level crossings must be provided to the same standard as that required for private level crossings (refer to section [10.0 Requirements for private level crossings](#)).

12.0 Requirements for tramway level crossings

12.1 Introduction

Under the Railways Act 2005, tramways are included within the definition of railway. However, there are some significant differences in the operation of, and the vehicles in use on, tramways compared with heavy railways.

Traditionally, tramways operate on roads and mix with other users, although reserved, off-road sections are a feature of many tramways. Some tramways in New Zealand are in a museum setting and do not, at this stage, operate on public roads, although there may be some simulated street operation within the site. However, there are tramways crossing public roads, while others use roads, wholly or partly, or plan to.

A second significant difference is the nature of the vehicles used. With heavy rail, long trains carrying heavy loads may be expected, while a typical older-style tram is a single vehicle, often less than 12m in length, which might, in some systems, be able to pull one trailer or perhaps two.

Overseas, modern trams are often modular and typically range 20–35m in length and their speed can vary from 50km/h or less in street running situations to up to 100km/h on reserved track. The relative lightness of the vehicles and the need for them to mix with other road users means they have braking systems that allow much shorter stopping distances than a typical railway train.

This all results in quite a different risk profile for trams compared with trains. This needs to be reflected in the controls and guidelines applied for tramway level crossings.

12.2 Tramway level crossings

The Railways Act 2005 definition of a level crossing (see section 2.2 *What is a level crossing?*) excludes '*a railway line on a road that is intended solely for the use of light rail vehicles*'. This means a tramway running along a road or across a road is not legally a level crossing. Thus, a tramway on a roadway crossing another roadway is not legally a level crossing, though it may well have controls such as Give Way or Stop signs or traffic signals. In these cases, the normal traffic rules for giving way and complying with signals apply to all traffic, including any tram.

12.2.1 Passive control

Where a tramway has right of way and a level crossing does not warrant active control, the level crossing Stop (RPX2) or Give Way (RPX3) assembly with the Tramway crossbuck (WXT or WXT1) should be used. The approach warning signs would include tram (WX2R or WX2L) signs rather than steam train (WX1R or WX1L) signs.

12.2.2 Active control

Where a tramway has right of way and the right to maintain full line speed, active warning systems should be of the railway type (ie FLB and, if necessary, barrier arms), with control systems with appropriate integrity levels.

Where the tramway does not have right of way, standard road traffic signals should be used.

The TCD Rule provides for red, yellow and white T-aspect signals where trams have a specific phase or may be permitted movements that other traffic facing the signal display do not.

Where trams are controlled by traffic signals, the signs normally associated with level crossings (ie those described in section 4.0 [Traffic signs](#)) must not be used.

12.2.3 Overhead wires

Tramway overhead wires generally operate at low voltages (500–600 V DC) and represent a lower risk than electrified main line railway voltages (operating at 1500V DC or 25kV AC). Installation of the low overhead clearance (RJ2E) assembly in advance of tramway lines may therefore be less critical. The assembly should be used when the tramway overhead wires are lower than 5m (normally 5.5–6m) or where there may be a risk of damage from over-height vehicles (eg in an environment where there are no other overhead wires).

12.3 Tramways as special vehicle lanes

Requirements for marking and signing tramways when they travel on a roadway and the conditions under which they operate could be covered by rules relating to special vehicle lanes in both the Land Transport (Road User) Rule 2004 and the TCD Rule. Guidance on these provisions will be included in the proposed part 14 Special vehicle lanes of the NZTA's TCD manual.

Appendix A - Standard sign and marking layouts

Figure A1 Minimum treatment annual average daily traffic (AADT) <100 vehicles per day (vpd)

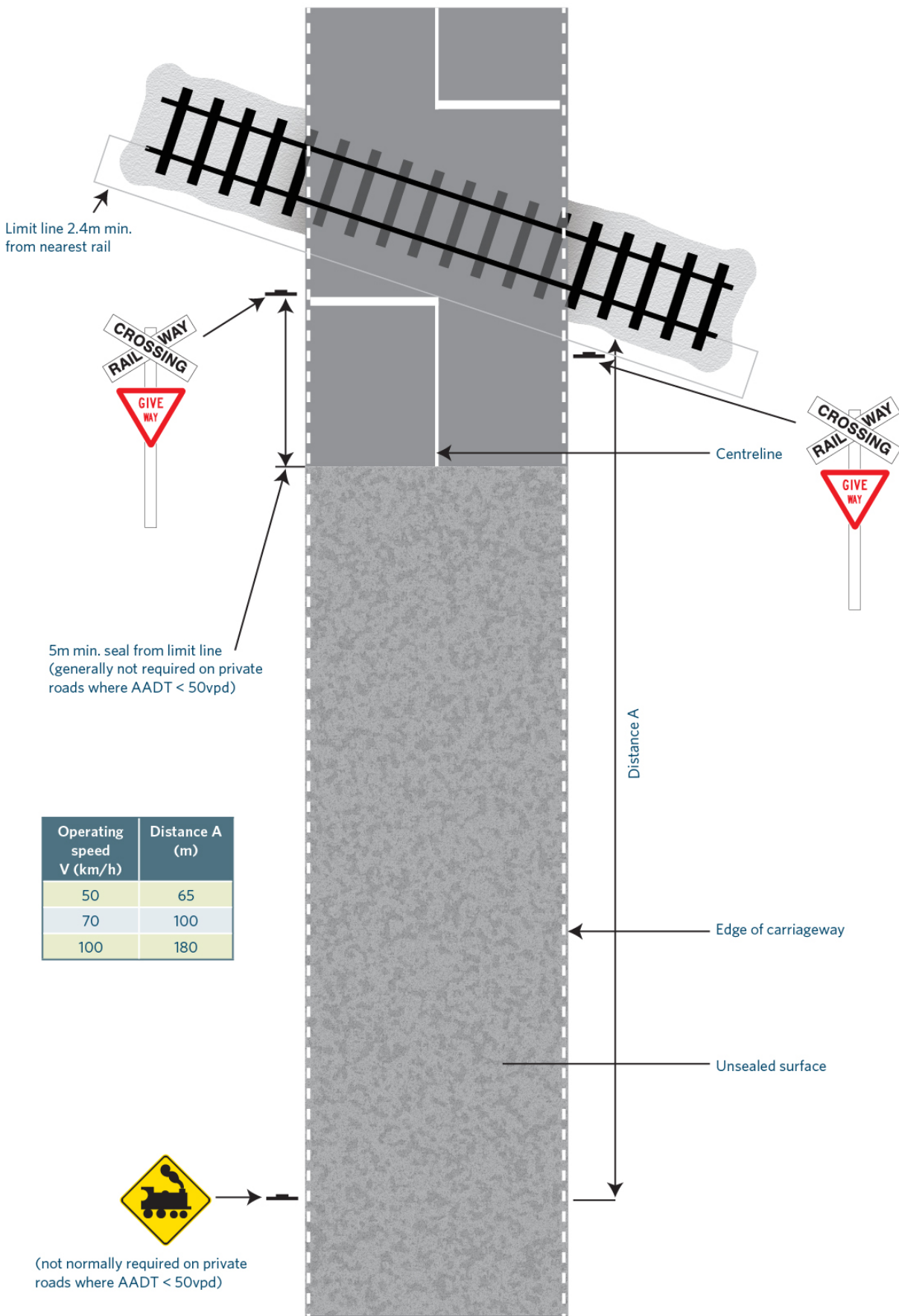

Figure A2 Give Way control

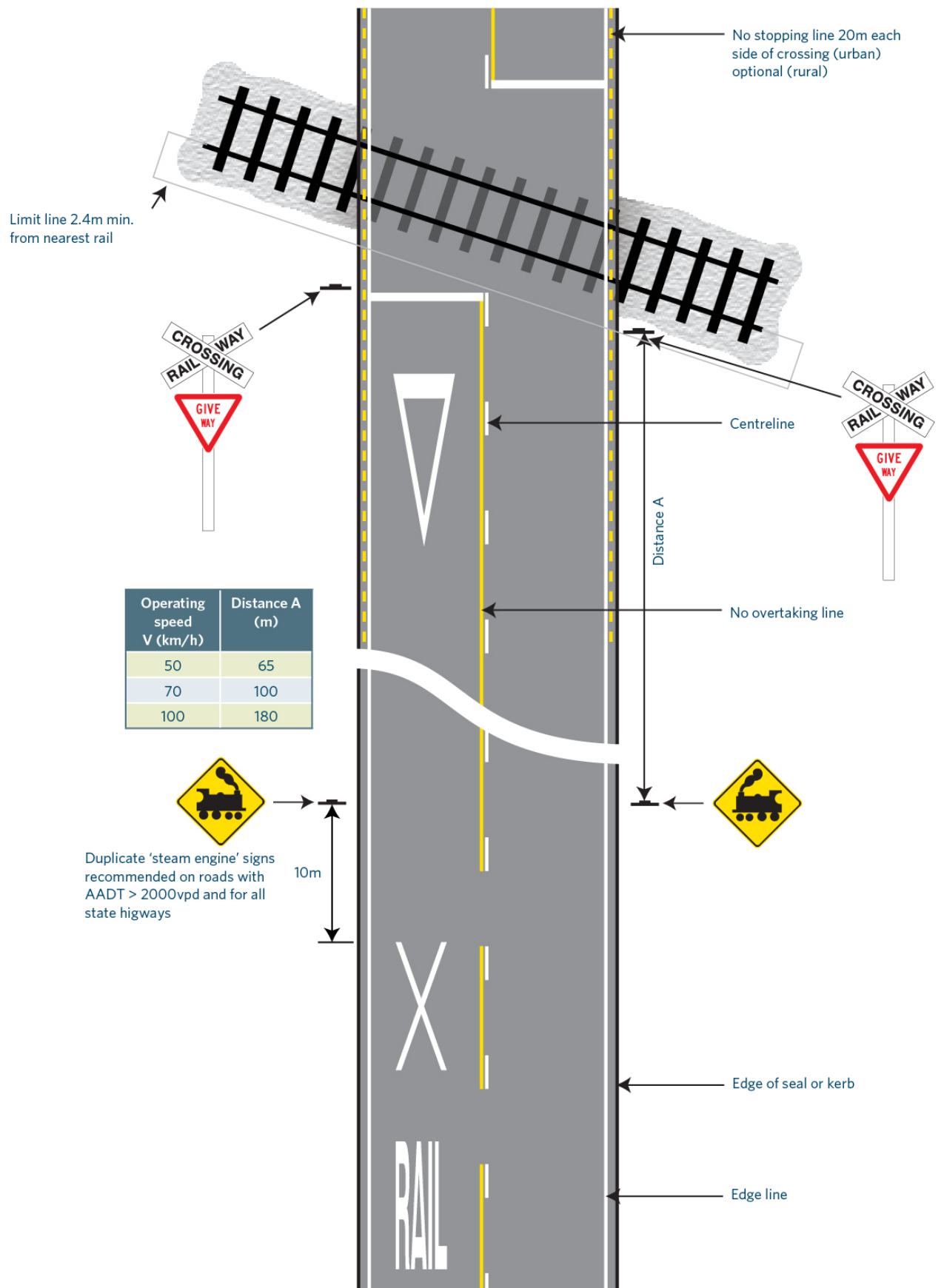

Figure A3 Give Way control with intermediate signs

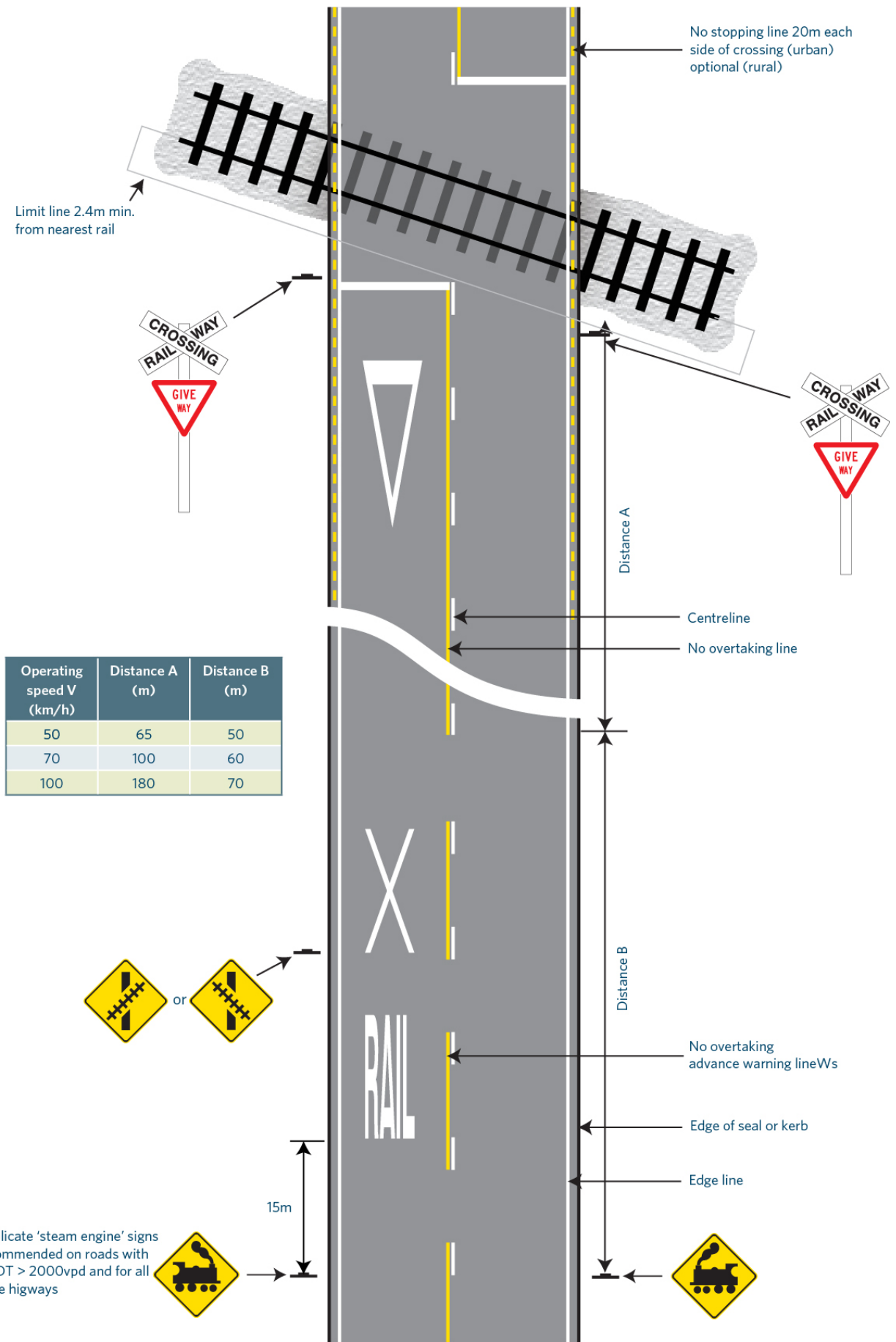

Figure A4 Stop sign control

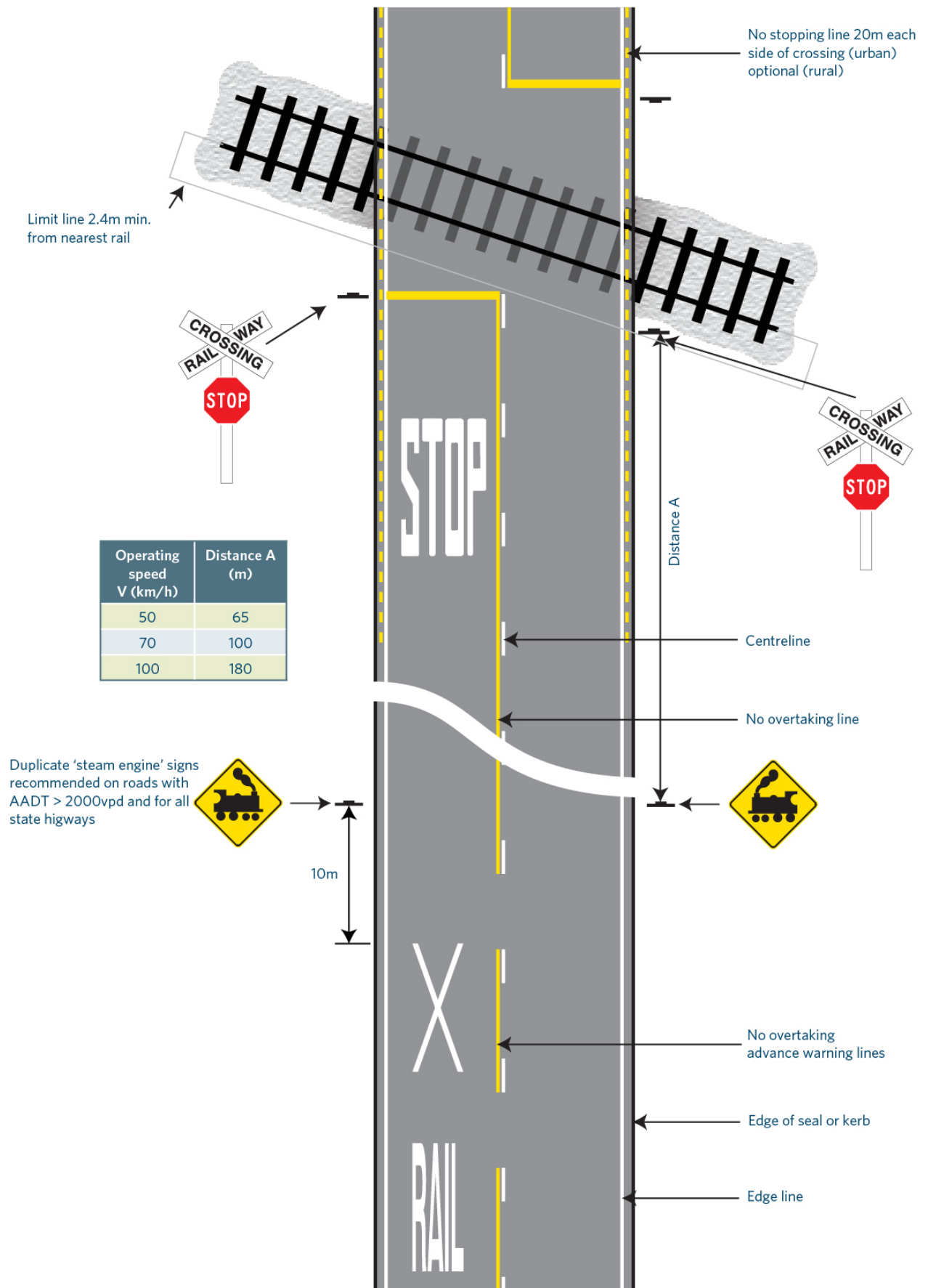

Figure A5 Stop sign control with intermediate signs

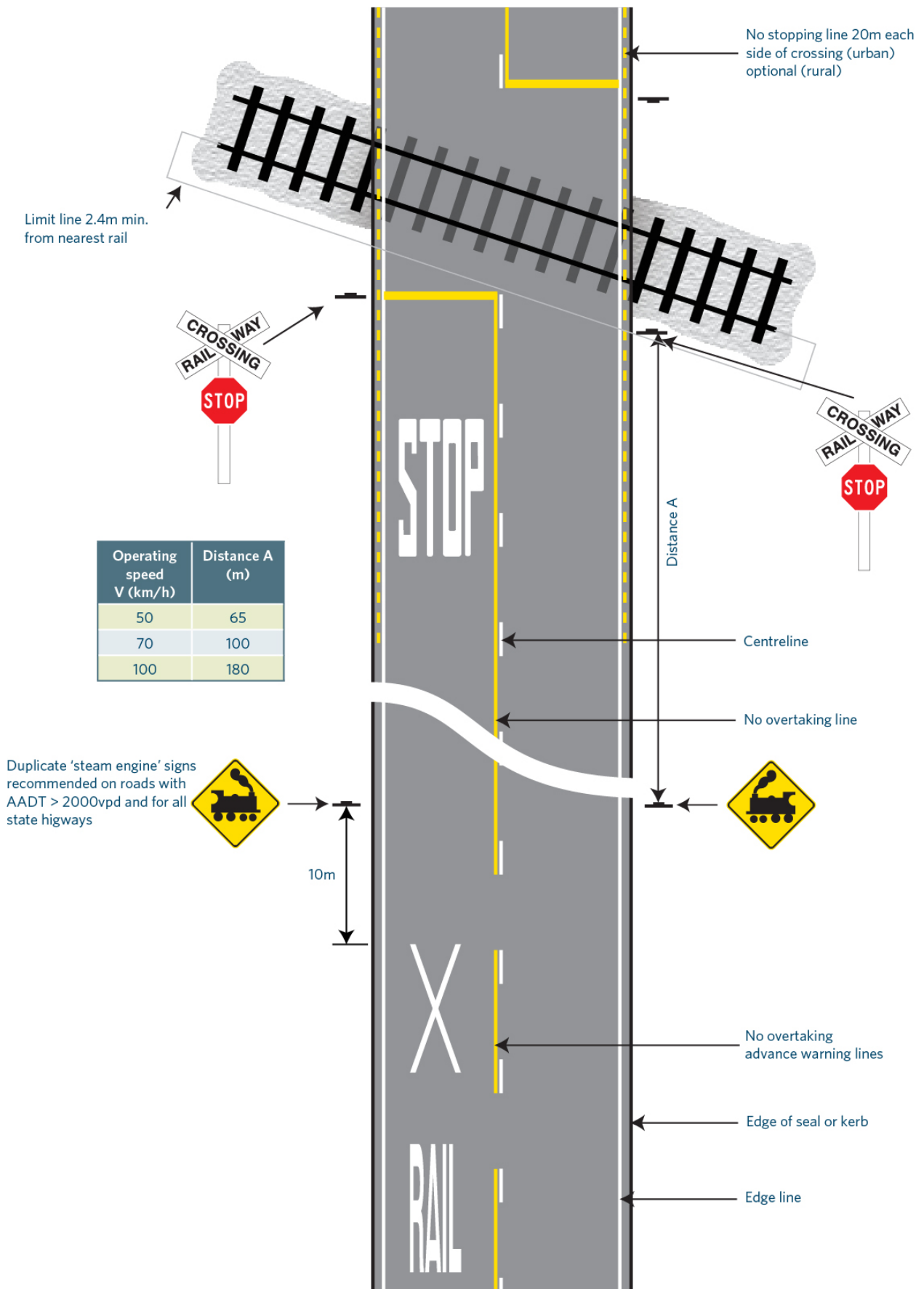

Figure A6 FLB or HAB active control

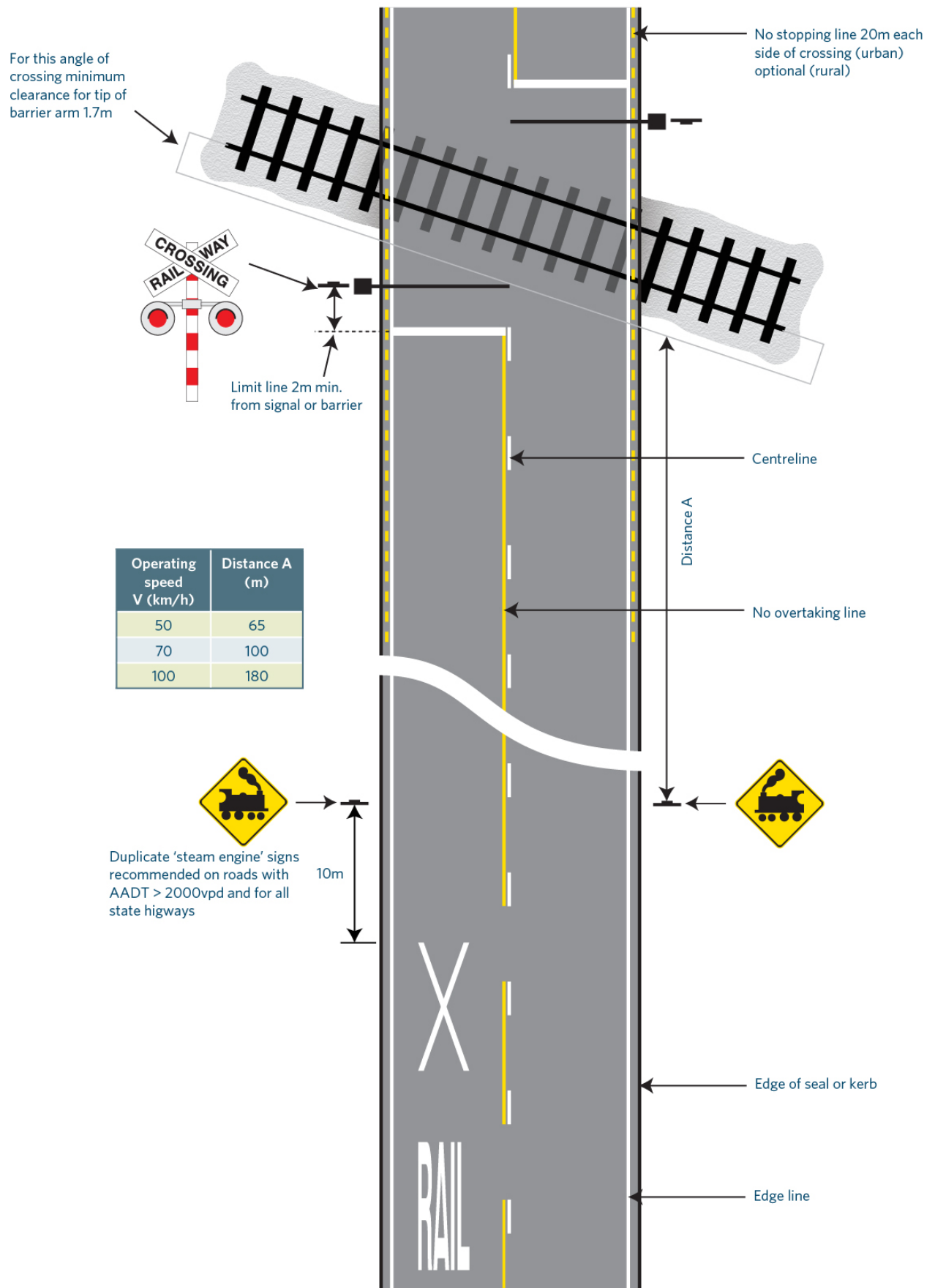

Figure A6.2 FLB or HAB active control with flush median

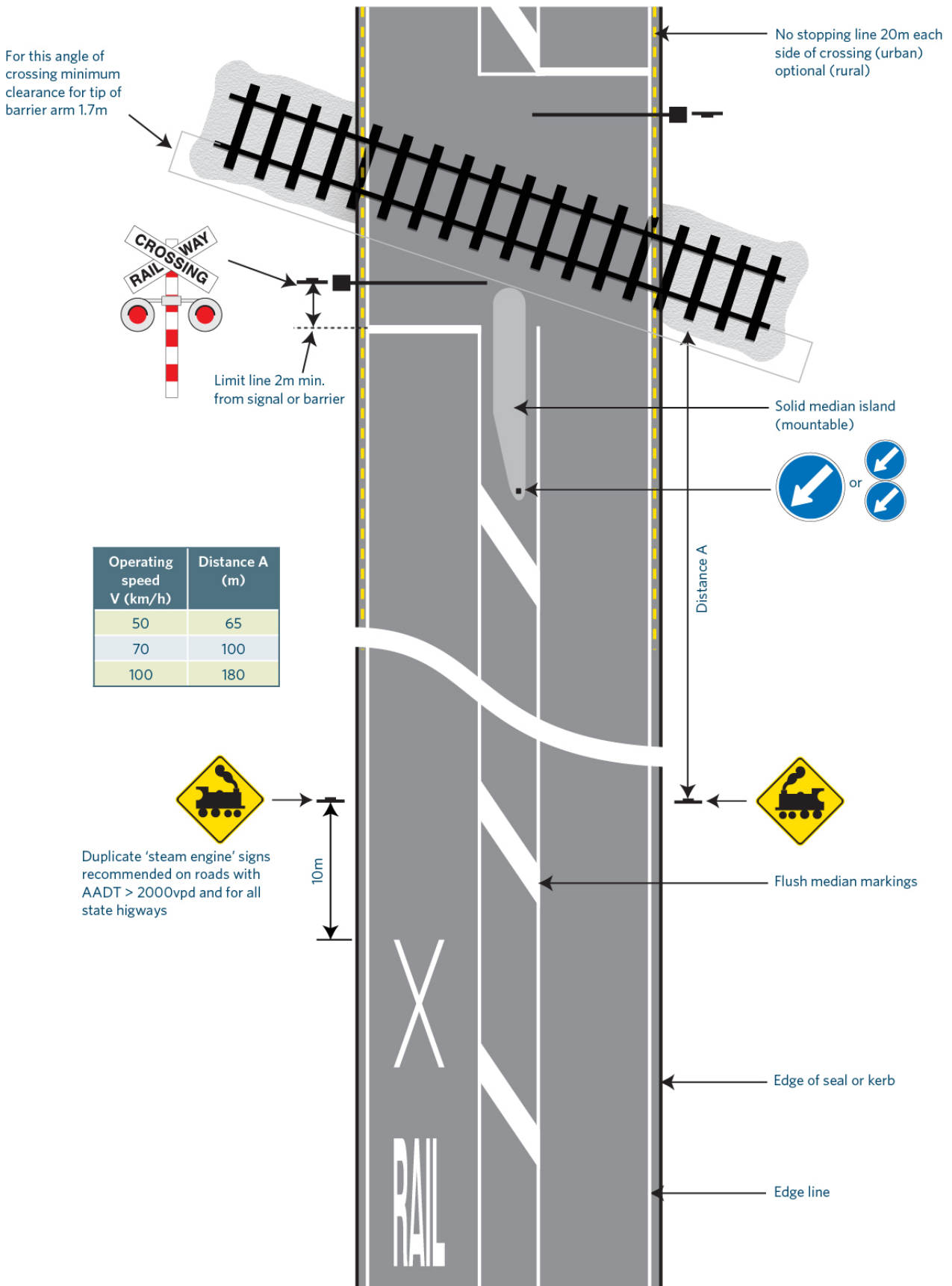

Figure A7 FLB or HAB active control with intermediate signs

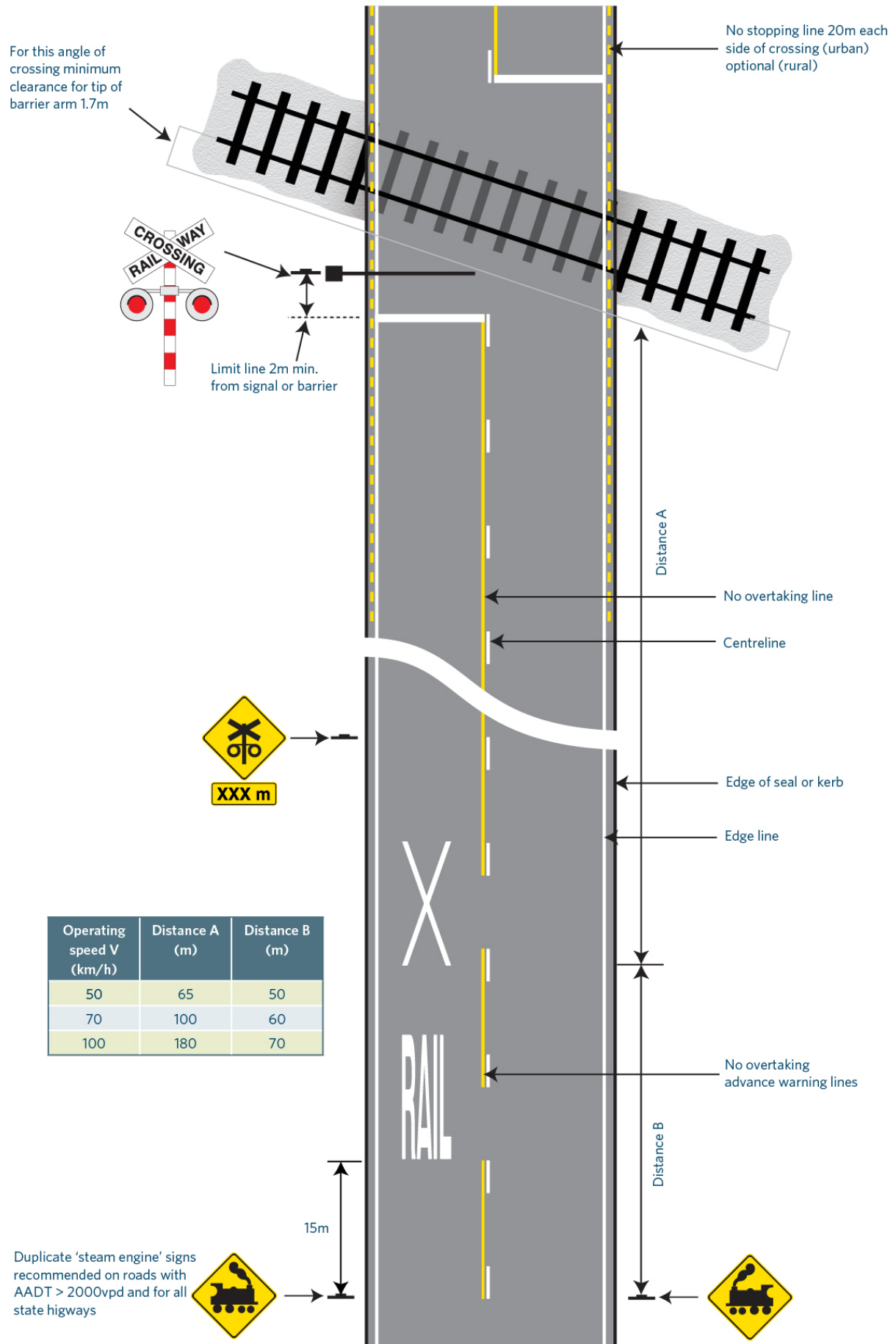

Figure A8 Multilane road with FLB or HAB active control

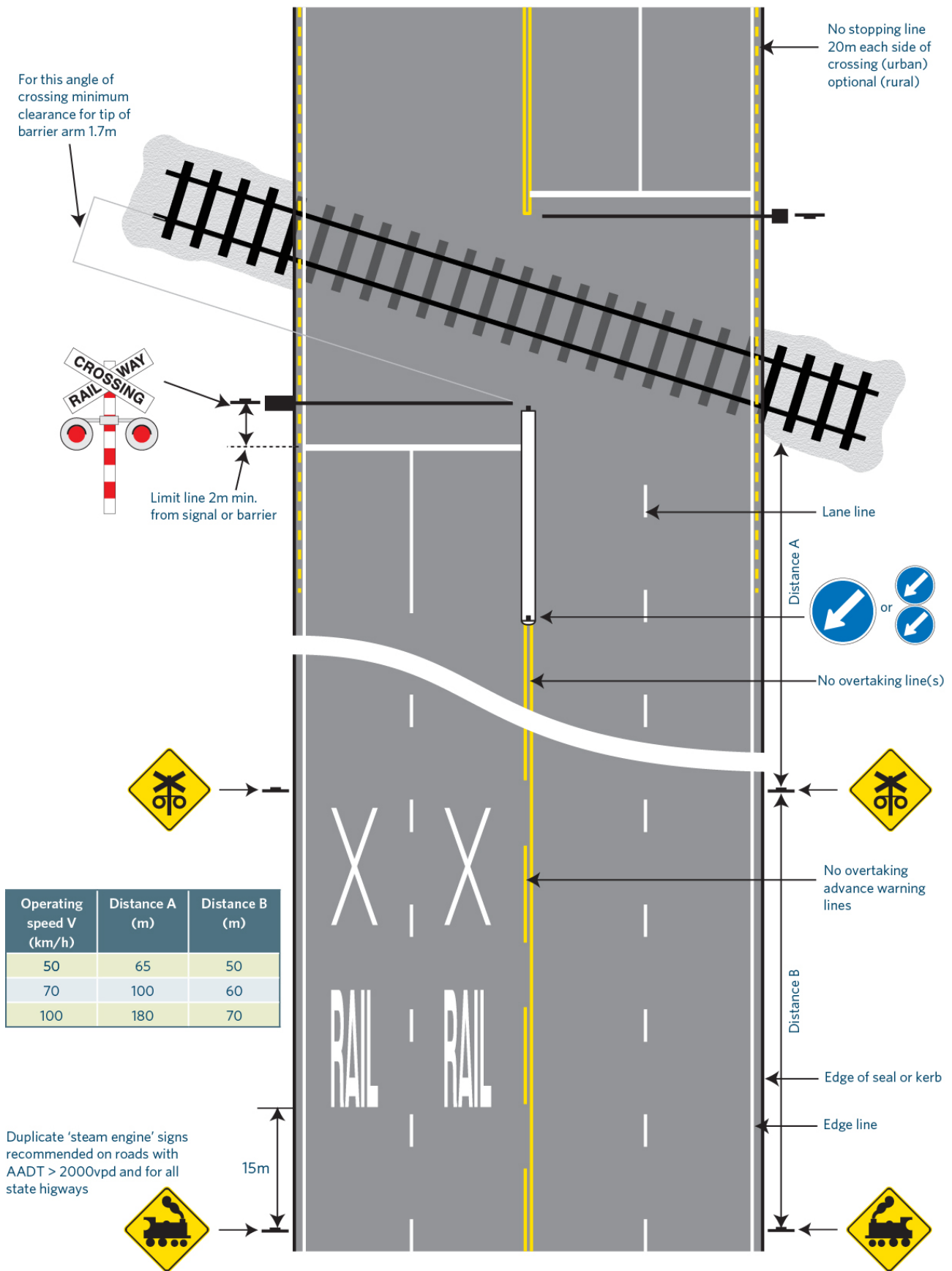

Figure A9.1 Intersection close to level crossing – distance (D) less than 10m

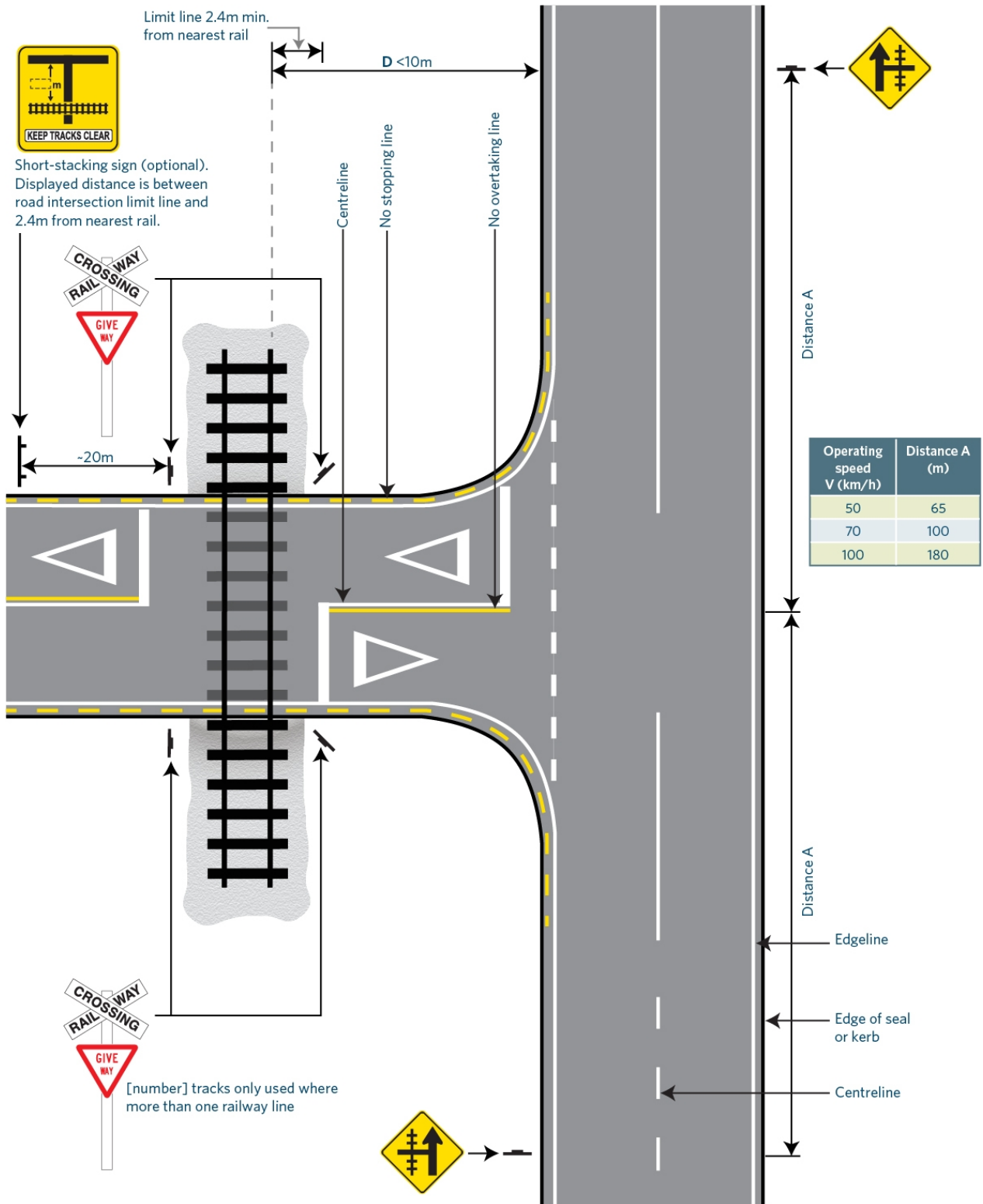

Figure A9.2 Intersection close to level crossing - distance (D) 10-30m

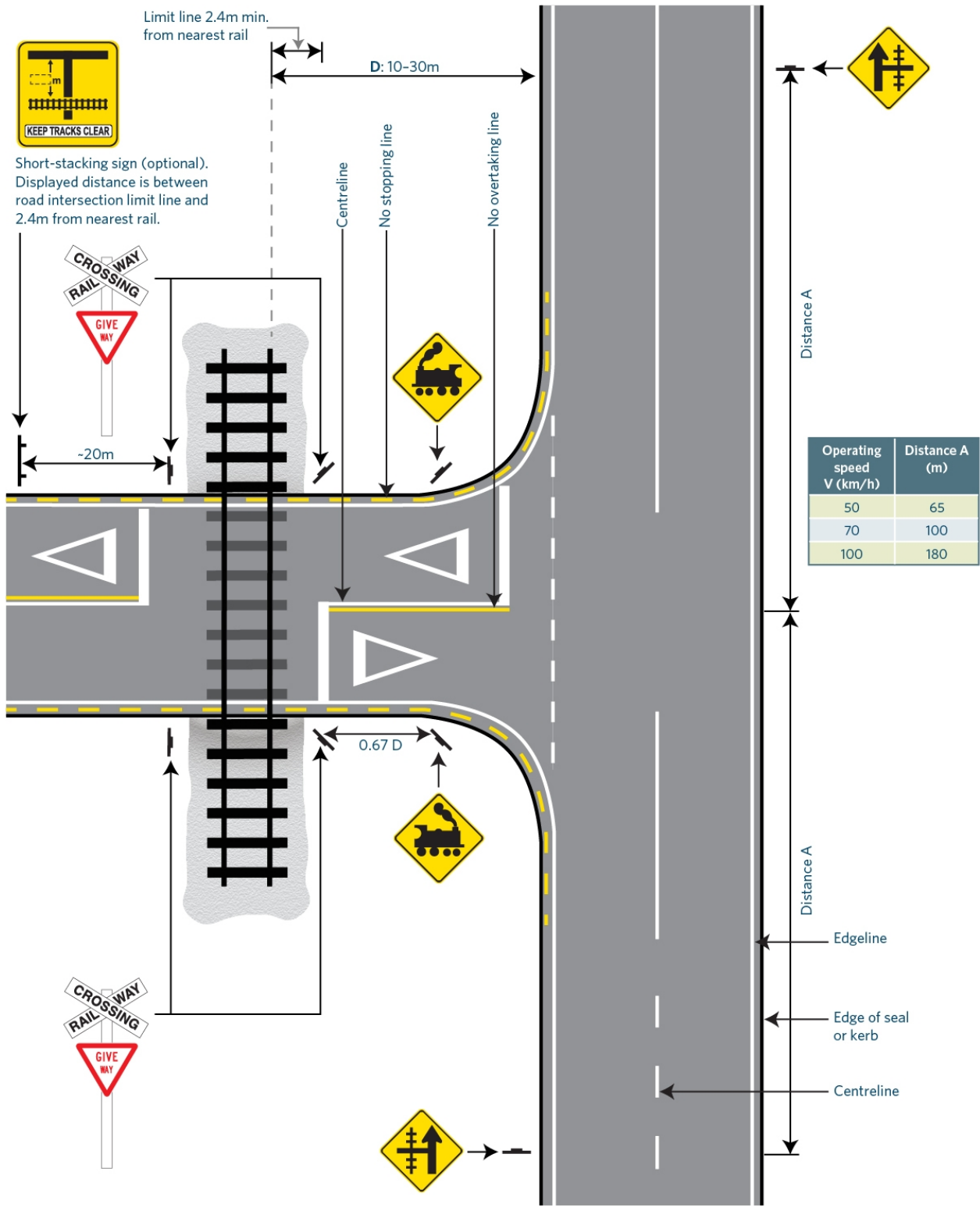

Figure A9.3 Intersection close to level crossing - distance (D) 30-60m

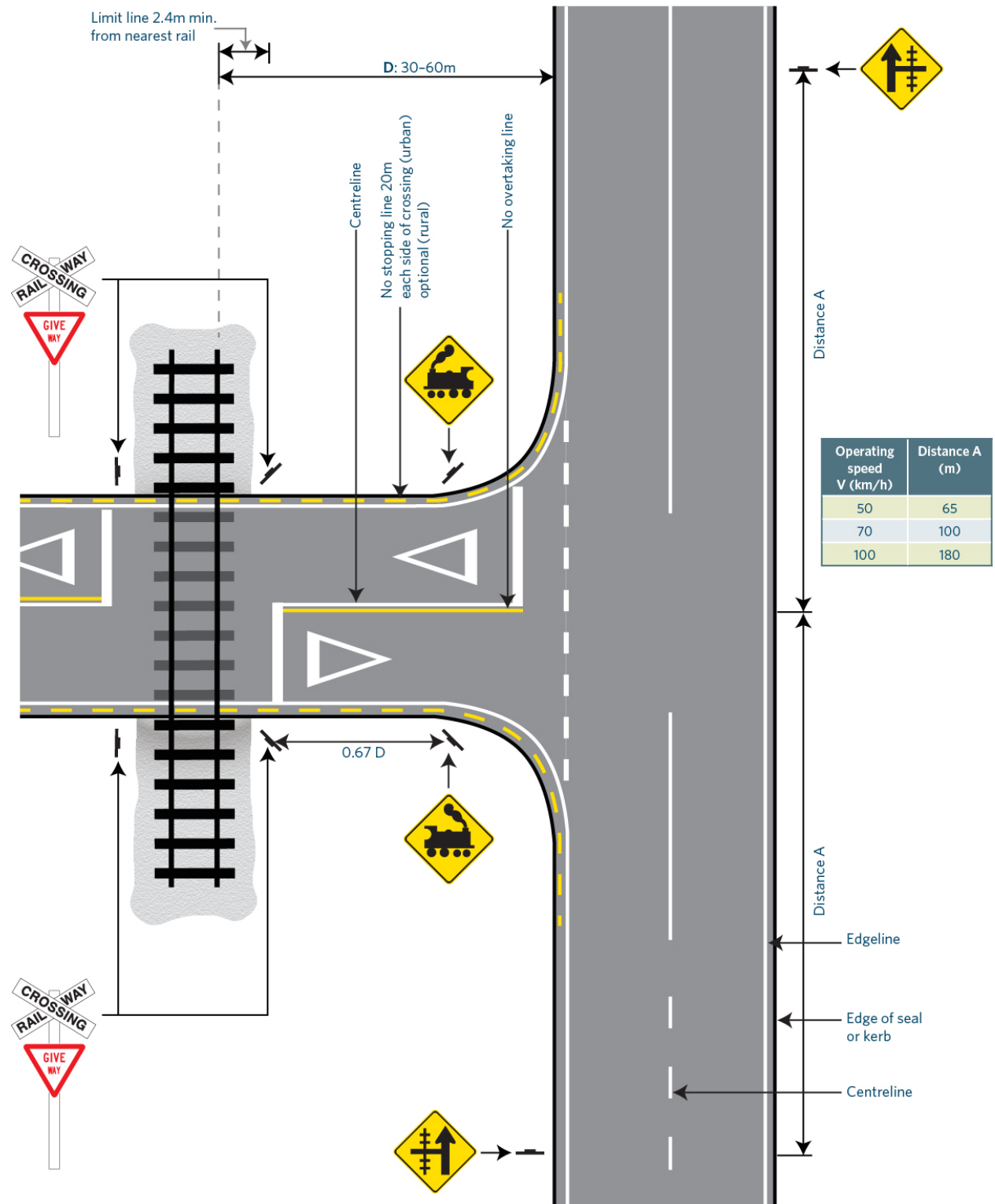

Figure A9.4 Intersection close to level crossing - distance (D) 60-100m

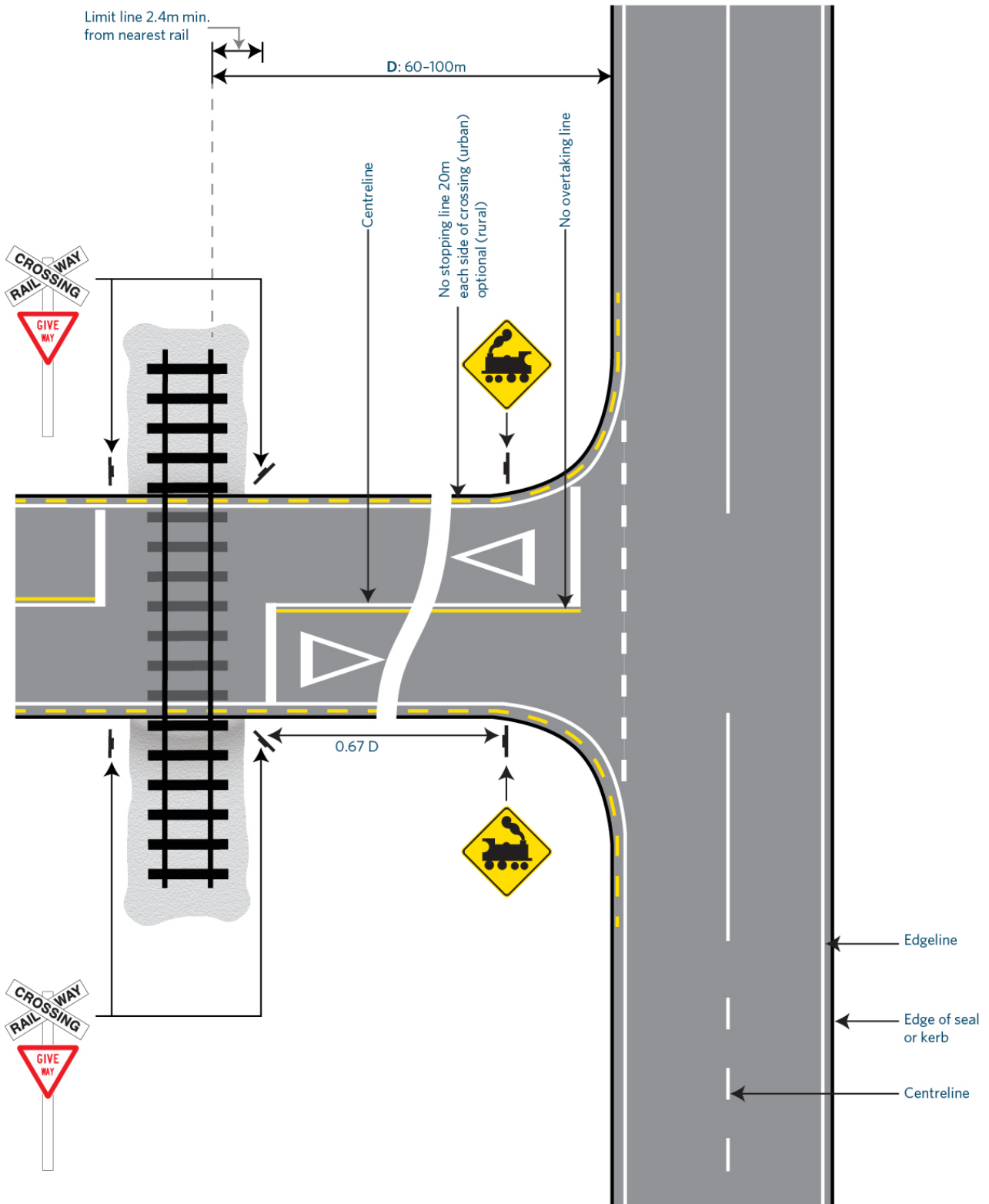

Figure A10 Curve preceding level crossing

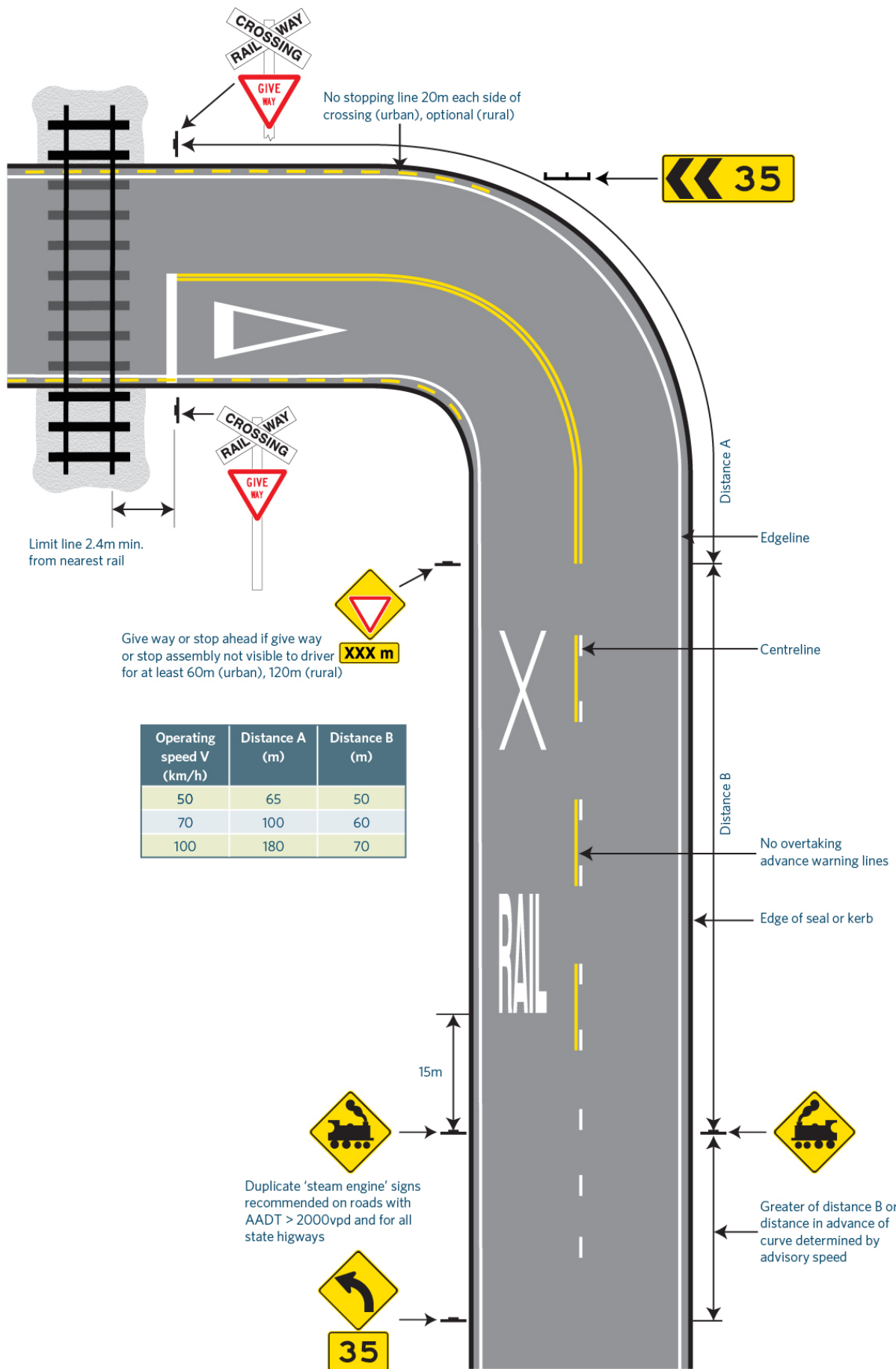

Figure A11 Rail X marking

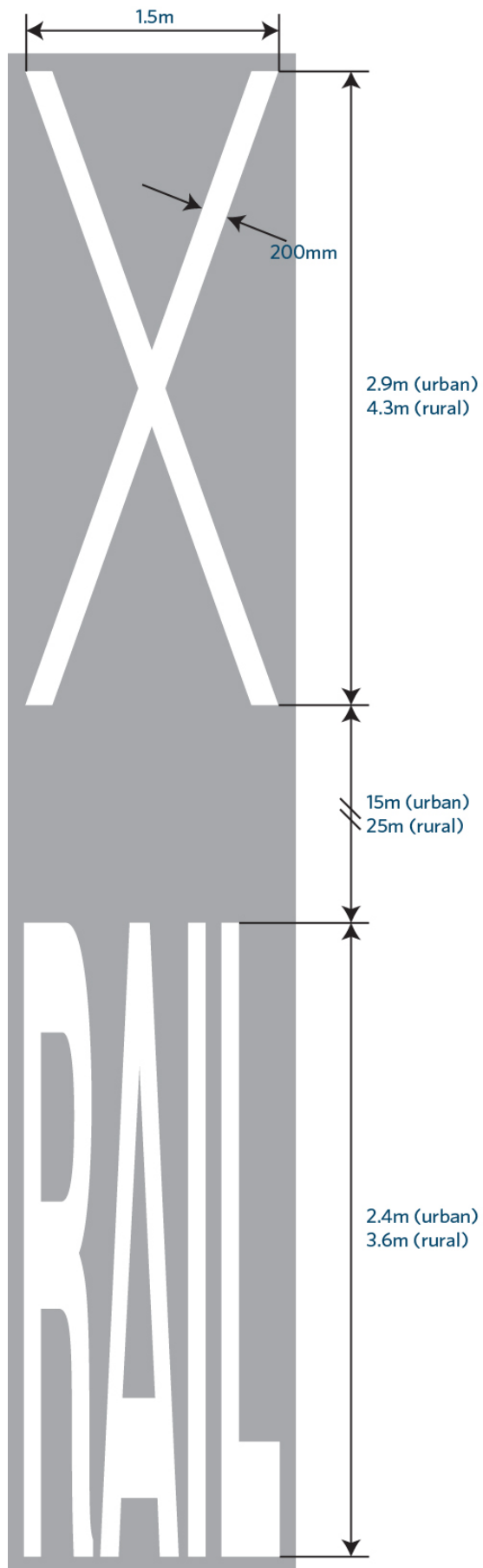

Figure A12 Cross-hatched clear zone marking

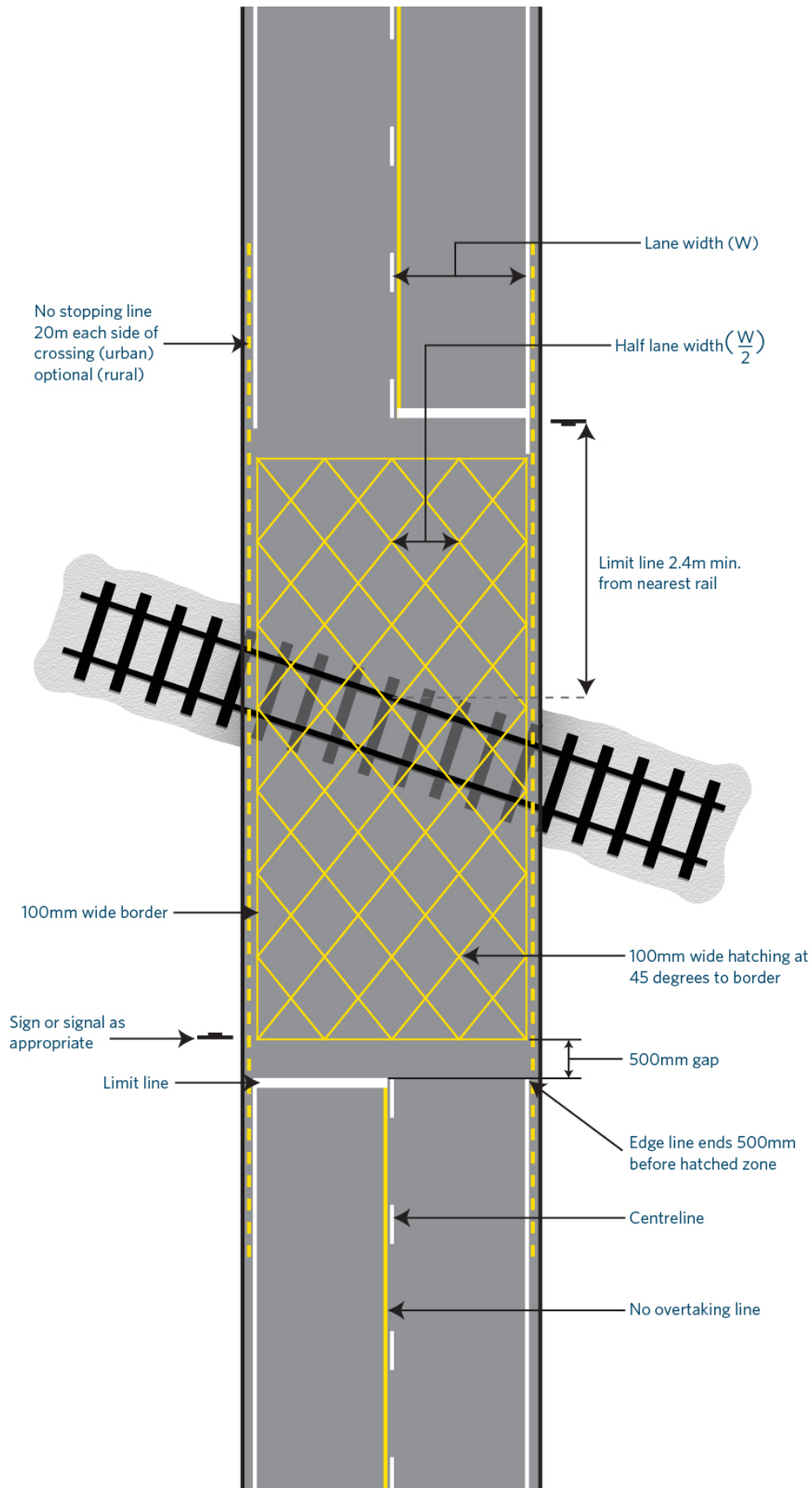
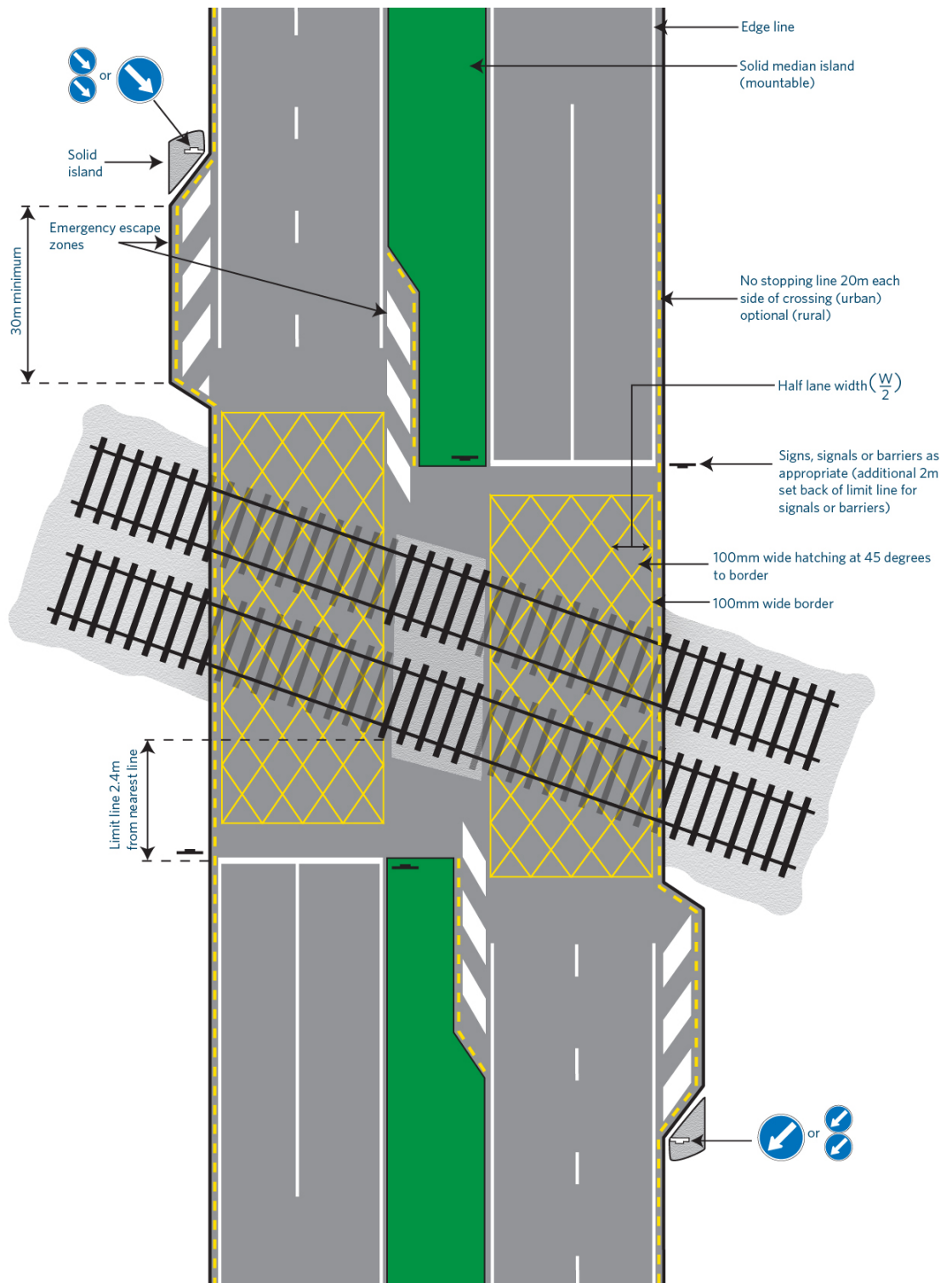

Figure A13 Emergency-escape zone



Appendix B - Sight distances at level crossings

B1 Introduction

Appendix B describes the formulae and parameters used to assess sight distance available at level crossings.

The design vehicles adopted for these calculations are:

- the maximum length vehicle generally able to use New Zealand roads without special conditions, namely 22m
- the maximum design vehicle, which is set at 25m (vehicles greater than 20m may use roads subject to conditions described in Land Transport Rule: Vehicle Dimensions and Mass 2002, which also requires vehicles over 25m long to have written permission from the rail access provider to cross any level crossing), or
- the maximum length single-unit vehicle (truck or bus) able to use New Zealand roads without special conditions, namely 12.6m (except for a limited number of buses which are permitted to be 13.5m).

Vehicle stopping, start-up and clearance parameters used for each of these vehicles are listed in [Table B1 Vehicle stopping, start-up and clearance parameters](#). The vehicle dimensions and performance characteristics used in these procedures are subject to change if new information becomes available.

When assessing sight distances at level crossings, views obstructed by permanent features such as terrain and buildings should be clearly distinguished from views obstructed by growth such as hedges or fencing. It is always preferable to remove view obstructions than install Stop controls at crossings. The Railways Act 2005 gives the rail access provider powers to remove or lower trees, hedges and walls that obstruct level crossing views.

B2 Approach visibility

A road vehicle driver approaching a level crossing with a Give Way (RP2) sign needs to be able to either:

- see an oncoming train in time to stop before reaching the level crossing, or
- continue at the approach speed and cross the level crossing safely ahead of a previously unseen train or a train far enough away to be clearly not a collision threat.

The required sight triangles to achieve this, shown diagrammatically in [Figure B1 Approach visibility at passive-controlled level crossings](#), are calculated as stated on the next page.

B2.1.1 Vehicle stops after seeing train and before reaching the level crossing

The value of S_1 , the minimum distance of an approaching road vehicle from the nearest rail at which the driver must be able to see an approaching train from either direction in time to stop if necessary before reaching the level crossing, ie to stop at the give way line, is given by:

$$S_1 = \frac{(R_T + B_T)V_V}{3.6} + \frac{V_V^2}{254(d + G)} + L_d + C_V \quad \dots(1)$$

Where:

d = coefficient of longitudinal deceleration (see [Table B3 Coefficient of deceleration for road vehicles \(trucks\)](#)).

G = approach grade in metres per metre, positive upgrade, negative downgrade.

R_T = total perception reaction time in seconds (general case assumption 2.5 seconds).

B_T = brake delay time in seconds (see [Table B1 Vehicle stopping, start-up and clearance parameters](#)).

Other notations are described in [Figure B1 Approach visibility at passive-controlled level crossings](#).

B2.1.2 Vehicle able to continue at speed and cross safely before train reaches level crossing

The sight triangle requirements are given by S_1 and S_2 in [Figure B1 Approach visibility at passive-controlled level crossings](#).

The value of S_1 is the same as in (a) above.

The value of S_2 , the minimum distance at which the road vehicle driver needs to be able to see the train approaching from either direction in order to cross safely ahead of it, is given by:

$$S_2 = \frac{V_T}{V_V} \left[\frac{(R_T + B_T)V_V}{3.6} + \frac{V_V^2}{254(d + G)} + \frac{W_T}{\sin Z} + 2C_V + L \right] \quad \dots(2)$$

Where:

L = length of design vehicle (see [Table B1 Vehicle stopping, start-up and clearance parameters](#)).

Other notations are defined in equation (1) or described in [Figure B1 Approach visibility at passive-controlled level crossings](#).

A train, if present, needs to be visible to a road vehicle driver between any two points within the sight triangle.

B3 Restart view

A road vehicle driver when stopped at the stop line needs to be able to see far enough along the railway to be able to start off, cross and clear the level crossing safely before the arrival of any previously unseen train. The required sight triangles to achieve this are shown diagrammatically in [Figure B2 Crossing visibility at passive-controlled level crossings](#).

Distance S_3 is the minimum distance at which an approaching train from either direction must be seen in order for the design vehicle to start off and clear the level crossing by the safety margin shown in [Figure B2 Crossing visibility at passive-controlled level crossings](#). Distance S_3 is given by the following:

$$S_3 = \frac{V_T}{3.6} \left[J + G_s \left[2 \frac{\frac{W_R}{\tan Z} + \frac{W_T}{\sin Z} + 2C_V + L}{a} \right]^{1/2} \right] \quad \dots(3)$$

Where:

J = sum of the perception time and time to depress clutch (general case assumption two seconds).

L = length of design vehicle (see [Table B1 Vehicle stopping, start-up and clearance parameters](#)).

a = average acceleration of the design vehicle in starting gear (see [Table B1 Vehicle stopping, start-up and clearance parameters](#)).

G_s = grade correction factor (see [Table B2 Grade correction factors](#)).

Other notations are described in [Figure B2 Crossing visibility at passive-controlled level crossings](#).

B4 Sighting angles

In order to ensure a motor vehicle driver can see along the prescribed sight triangles without excessive head movement or sight obstruction by parts of the vehicle itself, the following maximum sighting angles shown in [Figure B1 Approach visibility at passive-controlled level crossings](#) and [Figure B2 Crossing visibility at passive-controlled level crossings](#), measured from the direction of travel of the vehicle at the point or points at which sightings must be made, should be available:

- a. Maximum angles when approaching give way-controlled level crossings:
 - i. to the left (X_{1L}) - 95 degrees
 - ii. to the right (X_{1R}) - 110 degrees.
- b. Maximum angles when approaching stop-controlled level crossings:
 - i. to the left (X_{2L}) - 110 degrees
 - ii. to the right (X_{2R}) - 140 degrees.

For the purpose of calculating sight triangles, the following figures are used:

- Distance from driver's eye to the nearest rail when stopped at the stop line - 5m.
 - Height of driver's eye above road level - 1m.
 - Height of train headlight above rails - 2.6m.
-

B5 Vehicle deceleration factors

The value d , the coefficient of deceleration, in equations (1), (2) and (3) is the uniform deceleration rate for a vehicle approaching a level crossing that may be required to stop on the approach due to the presence of a train and is given in table B3 below.

Table B1 Vehicle stopping, start-up and clearance parameters

Vehicle type [see B1]	B_T (s)	J (s)	L (m)	a (m/s ²)
Maximum length vehicle	1.0	2.0	22.0	0.36
Maximum design vehicle	1.0	2.0	25.0	0.36

Table B2 Grade correction factors

Grade (m/m)	Grade correction factor (G_S)
-0.12	0.52
-0.10	0.57
-0.08	0.63
-0.06	0.70
-0.04	0.79
-0.02	0.88
0.00	1.00
0.02	1.12
0.04	1.25
0.06	1.39
0.08	1.54
0.10	1.69
0.12	1.85

Table B3 Coefficient of deceleration for road vehicles (trucks)

Vehicle speed (km/h)	Coefficient of deceleration (d)
< 95	0.29
95-105	0.28

Figure B1 Approach visibility at passive-controlled level crossings

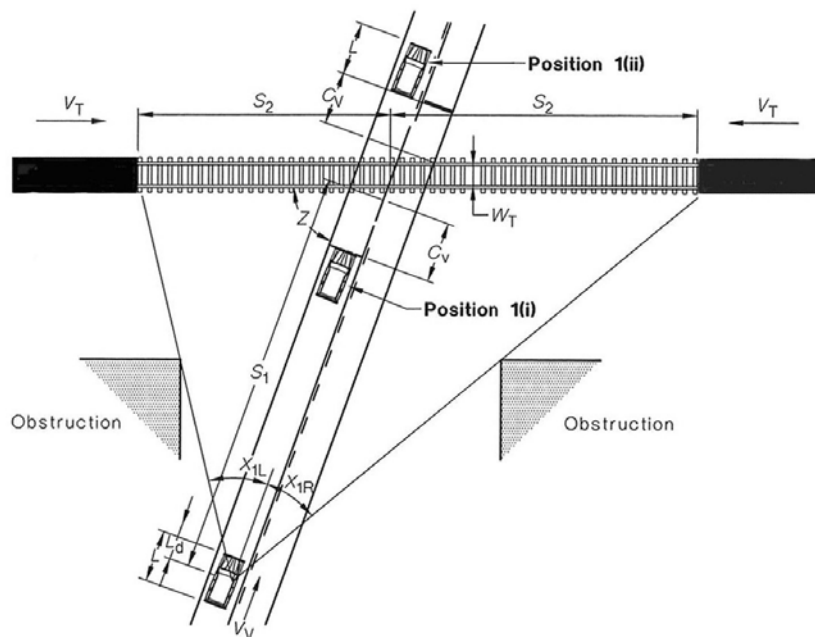

Position 1(i): Driver approaching level crossing sights train, judges that a stop is needed, decelerates and stops at the limit line.

Position 1(ii): Driver approaching the level crossing either cannot see approaching train or sights train too far distant to be a collision threat, continues at speed and crosses ahead of the train.

Legend (general case assumptions are shown in brackets):

- S_1 = minimum distance of an approaching road vehicle from the nearest rail when driver must be able to see an approaching train in time to stop if necessary before reaching the level crossing limit line (m).
- S_2 = minimum distance of a train from the level crossing at which a road vehicle driver at distance S_1 from the level crossing can proceed at speed and safely clear the level crossing ahead of that train (m).
- V_T = the highest-authorized speed of a train approaching the level crossing (km/h).
- V_V = the 85th percentile road vehicle speed at the position at which a driver will first recognise and react to the level crossing controls (km/h). (The road speed limit plus 10 percent may be used where the 85th percentile speed is not known.)
- C_V = clearance from the vehicle limit line to the nearest rail (general case assumption 2.4m).
- L_d = distance from the driver to the front of the vehicle (general case assumption 2m).
- W_T = width, outer rail to outer rail, of the railway lines at the level crossing (m).
- X_{1L}, X_{1R} = sighting angles (see B4).
- Z = angle between the road and the railway at the level crossing (degrees).

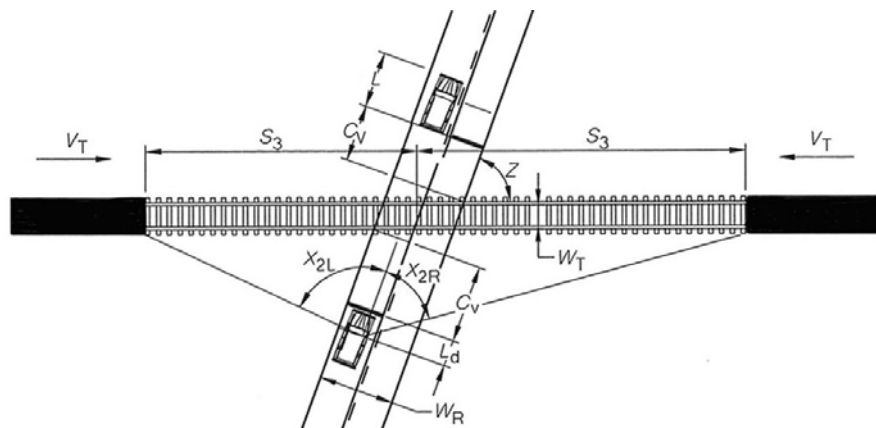
Figure B2 Crossing visibility at passive-controlled level crossings

A motorist stopped at a level crossing requires adequate time to accelerate and safely clear the level crossing.

Legend (general case assumptions are shown in brackets):

- S_3 = minimum distance of an approaching train from the centre of the level crossing, when the road vehicle driver must first see an approaching train in order to safely clear the level crossing ahead of that train (m).
- V_T = the highest-authorized speed of the train approaching the level crossing (km/h).
- L_d = distance from the driver to the front of the vehicle (general case assumption 2m)
- C_v = clearance from the vehicle stop line to the nearest rail (general case assumption 2.4m).
- W_R = width of the travelled way (portion of the roadway allocated for the movement of the vehicles) at the level crossing (m).
- W_T = width, outer rail edge to outer rail edge, of the railway lines at the level crossing (m)
- X_{2L}, X_{2R} = sighting angles measured from the stop line (see B4).
- Z = angle between the road and the railway at the level crossing (degrees).

B6 Pedestrian sight distances

At a level crossing where there is no active control for either roadway or pedestrian traffic, for a train approaching from either direction, the sight distance (SD) in metres to oncoming trains to enable pedestrians to cross safely is as follows:

$$SD = \frac{V_T}{3.6} \left[\frac{D}{V_P} + 2 \right] \quad \dots(4)$$

Where:

- V_T = the highest-authorized speed of the train approaching the level crossing (km/h)
 - V_P = the walking speed of pedestrians normally adopted as 1m/s. Where there is significant use by mobility-impaired pedestrians, a walking speed of 0.8m/s is recommended. The formula also provides a safety margin of two seconds providing, eg an allowance for pedestrian reaction and acceleration time
 - D = the pedestrian level crossing distance in metres, measured as follows:
 - where pedestrian mazes are provided - from one pedestrian maze opening to the other
 - where there are no pedestrian mazes but there are tactile ground surface indicators (TGSIs) at holding positions - from one trackside edge of the TGSIs to the other
 - where there are no pedestrian mazes or TGSIs - from outer rail to outer rail plus 4.8m (standard rail gauge is 1.07m, thus for a single railway line D would be 5.87m while for a double railway line D would typically be 9.87m).
-

B7 Example view lines

Table B4 Examples based on equations 2, 3 and 4 provides some example outcomes from equations 2, 3 and 4 based on differing train speeds, vehicle lengths or pedestrian safety margins, and incorporates some typical values for the other parameters used.

Table B4 Examples based on equations 2, 3 and 4

Train speed V_T (km/h)	Restart view S_3 (m)		Approach visibility S_2 (m)		Pedestrian view SD (m)
	Vehicle length L		Vehicle length L		
	12.6m	25m	12.6m	25m	
40	149	179	97	121	87
70	261	313	169	213	153
80	298	358	193	243	175
100	373	448	242	304	219
110	410	492	266	334	240

The notations and parameters used for these calculated distances are described in table B5 below.

Table B5 Notations and parameters used in calculations for values for table B4

Parameter	Notation and values
Highest-authorized train approach speed	V_T
View along the railway line at 5m from nearest rail	S_3
Minimum view along the railway line at 30m from the nearest rail based on a driver approaching the level crossing slowing to 20km/h (V_V)	S_2
Desirable view along the railway line at 4m from the nearest rail for all pedestrian level crossings, unless automatic warning devices have been installed	SD
Vehicle lengths - the maximum length of a rigid unit vehicle (eg truck or bus) is 12.6m (except for a limited number of buses which are permitted to be 13.5m). However, truck and trailer combinations are, subject to restrictions, permitted to be 25m long without requiring a special over-length permit. These two vehicle lengths have been chosen for the purposes of the example calculations in Table B4 Examples based on equations 2, 3 and 4	$L = 12.6m$
	$L = 25m$
Approach grade	$G = 0$
Deceleration rate of truck	$d = 0.29$
Perception plus reaction time	$R_T = 2.5$ sec
Brake delay	$B_T = 1.0$ sec
Start-off time (including brake delay)	$J = 2.0$ sec
Vehicle acceleration across crossing	$a = 0.36m/sec^2$
Vehicle 85th percentile speed	$V_V = 20km/h$
Set-back limit line from nearest line	$C_V = 3m$
Driver's eye from front of vehicle	$L_d = 2m$
Distance a pedestrian walks - WT plus 4.8m	$D = 5.87m$
Pedestrian walking speed	$V_p = 1.0m/sec$
Width of the roadway at the crossing	$W_R =$ No effect if $Z = 90^\circ$
Width, outer rail to outer rail, of the railway lines - assumed to be single track	$W_T = 1.07m$
Angle between road and railway at the crossing	$Z = 90^\circ$
Grade correction factor - based on approach grade $G = 0$	$G_S = 1.0$

Appendix C - Working on or near level crossings

C1 Introduction

When work takes place on or near a level crossing, the resultant activity (including the equipment and personnel used) can obscure signs, markings or signals or force drivers into positions on the road where they cannot clearly see these devices.

Rail access provider oversight of road works near level crossings concentrates on ensuring there is no effect on the rail infrastructure but they also need to consider rail operational issues and options. These may include reducing train speeds (frequently done through rail work sites) or introducing manual control of automatic signal systems.

People involved in approving traffic management plans for road works are frequently familiar with the locality of the work. However, if the plans make no mention of nearby rail facilities, particularly level crossings and associated traffic control devices existing within the proposed work site, the likely outcome is inadequate consideration of the possible implications arising from rail and road vehicle interaction or the effect the work might have on traffic control devices currently in place.

C2 Notification and approval processes

The chain of responsibility can be extensive for any work on the road - from the RCA as principal to the person working on the road. When a similar chain exists on the rail side (eg from the rail access provider as principal to the rail worker), opportunity for a breakdown in critical communication between the two responsible authorities clearly escalates.

The NZTA's TCD manual, part 8 Code of practice for temporary traffic management (CoPTTM) highlights the need for the consideration of the safety issues related to works near level crossings and requires contractors to notify the rail access provider of their proposed works.

Rail access providers should also have clear procedures when RCAs or their delegates seek approvals in relation to work planned near the railway corridor, particularly on roads approaching level crossings.

In addition, rail access providers should provide contractors with defined procedures when work is conducted within the rail corridor, particularly work at level crossings that could affect traffic on a road. This will include requirements to advise and, where necessary, gain agreement of the RCA to a traffic management plan.

C3 Traffic management plans

Whenever both rail and road corridors are within a work site, any traffic management plan must consider implications of the work and associated controls on the safe operation of each corridor.

It is essential that critical features such as railway lines and traffic control devices (such as flashing light assemblies) are included on plans. This will ensure those involved in the design and approval of the plans fully consider the implications of the work on all traffic (including road and rail vehicles) through the site as required by CoPTTM.

If work on the road will reduce the effectiveness of traffic control devices, reduce visibility of approaching trains or otherwise impact on safety, the rail access provider would need to be satisfied there are no alternate treatments and also consider what changes to their normal operating procedures could be justified. This may include reducing train speeds, installing temporary traffic control changes, requiring some positive traffic control at the work site for the level crossing.

Work being carried out by rail contractors on the rail corridor might likewise affect the road network. The RCA can introduce steps that might readily mitigate these effects and improve worker and public safety may include, eg reduced speed limits and appropriate traffic control.

C4 Permits to enter rail corridor

Anyone who wishes to work in the railway corridor must obtain a permit to enter issued by the rail access provider or railway premises owner. This permit is required for all access onto the railway corridor regardless of:

- the distance from the railway line
- whether the railway line is operational or not
- work being in a rail facility (eg marshalling yards, depots, workshops where railway lines and level crossings are present).

In electrified areas, the nature of the work to be undertaken may require an electrical safety permit to work. This permit will generally be required when working within 4m of overhead traction wires (train power supply lines).

Both these permits are subject to a fee and, depending on the nature of the work, may require the rail access provider or railway premises owner to provide a protection employee at the working party's cost.

C5 Rail participant requirements

Rail participants may have additional requirements for work within rail yards or sidings. Contact with the operator is required to determine the additional requirements for working in these areas.

C6 Obtaining permits

All agencies must be contacted directly to determine their individual requirements for access to operational areas. Permits from KiwiRail are obtained through local area offices. Their locations and contact details are detailed on the KiwiRail's website www.kiwirail.govt.nz.

Appendix D - Australian Level Crossing Assessment Model (ALCAM)

Appendix D is the current document produced by the national ALCAM group. Some terminology is not commonly used in New Zealand but in context the meaning should be clear. One aspect of ALCAM still to be worked through in New Zealand is the relationship between any outcome and the economic criteria used in the NZTA's *Economic evaluation manual* (EEM). This appendix is therefore subject to change arising from the ongoing work of the national ALCAM group and also from analysis of relationships with the EEM.

D1 Summary

ALCAM is an assessment tool used to identify key potential risks at level crossings and to assist in the prioritisation of crossings for upgrades. The risk model is used to support a decision-making process for both road and pedestrian level crossings, and to help determine the most cost-effective treatments.

ALCAM is currently applied across all Australian states and in New Zealand. The model is overseen by a committee of representatives from the various jurisdictions of these countries to ensure its consistency of development and application.

The ALCAM model comprises three separate components: the infrastructure model, the exposure model and the consequence model. When combined, these three components produce a unique risk score for each level crossing.

ALCAM can be used to:

- quantify the probability of an accident
- quantify the expected consequences of an accident
- compare the relative risk between crossings within a region or jurisdiction
- carry out a cost-benefit analysis of any improvements
- highlight where specific risks or deficiencies exist
- model the effect of cost-effective treatments to address these risks.

A total data management system is used, the Level Crossing Management System – (LXM), to allow for the effective management of ALCAM data as well as other important information. LXM contains a number of additional reporting and modelling tools to assist with the overall decision-making process. The model should be applied by road and railway engineers trained in the use of ALCAM.

Although it is a comprehensive tool for the assessment of level crossing hazards, ALCAM cannot be applied in isolation and does not preclude the need for sound engineering judgement. Any risk assessment and treatment also needs to consider other factors, including:

- collision and near-collision history
 - engineering experience (both rail and road)
 - local knowledge of driver or pedestrian behaviour
 - social and economic assessment
 - standards and international best practice.
-

ALCAM does not provide warrants for upgrades or attempt to define a safe or acceptable level of risk. This is a decision for each jurisdiction and will depend on the standard of existing crossings, upgrade budgets and the level of risk that they are prepared to tolerate.

It is also very important to ensure that all stakeholders associated with the particular level crossing are involved with the determination of the final recommended treatment.

D2 Introduction

Each state and territory in Australia and New Zealand is responsible for road and rail transport regulation within its jurisdiction. Each jurisdiction has a level crossing safety strategy committee comprising high-level management representation from both road and rail authorities. These committees are chartered with the continuing improvement of safety at level crossings within their jurisdiction.

The major difficulty in addressing risks at level crossings is the determination of how to achieve the optimal results with the available resources. Various methods of level crossing analysis were utilised involving basic risk allocation combined with the accident history at the site. These methods were often subjective and were not robust enough to adequately address some of the more complex safety hazards or compare different risks.

A tool which consistently assessed the characteristics at each level crossing was required to effectively determine priorities when addressing safety hazards at these level crossings. A project team was formed to establish such a tool. This was known as ALCAM and the model has undergone a variety of improvements to reach the stage it is at today.

The main benefits of ALCAM and the LXM system include:

- the ability to objectively rank level crossings within a jurisdiction or region
- best-practice risk assessment methods that include site conditions, exposure, consequence and total risk
- model output in common-quantitative terms (probability and expected fatalities), enabling cost-benefit analysis and integration into road-funding models
- the identification of specific risk characteristics
- assessment of the overall effects of proposed treatments
- the provision of a level crossing asset management database
- a means by which road and rail authorities can liaise with each other in respect of their individual and joint legislative and public risk reduction responsibilities
- the capacity to measure the reduction or elimination of road-rail interface risk as defined by the Australian National Transport Commission (NTC), Model Rail Safety Bill 2006 and the various jurisdictions rail safety legislation
- the capacity for each railway crossing safety dollar to be spent where it can best generate the greatest safety improvement, by allowing the amount of capital investment in railway crossing safety to be applied to a far larger number of risk mitigation measures.

ALCAM is overseen by a committee of representatives from Australian states and territories, as well as KiwiRail and the NZTA to ensure its consistency of development and application.

D3 ALCAM in New Zealand

The Level Crossing Working group (see Preface) first became aware of the Level crossing risk scoring matrix (the predecessor of ALCAM) developed by Queensland Rail from a paper by Hughes in 2002². Subsequently, New Zealand was invited to participate as an observer in the work of an inter-state working group looking at implementation of the Australian Rail Crossing Safety Strategy and observed the general acceptance of the basic Queensland risk scoring matrix by the other states and its evolution into ALCAM. It offered advantages in terms of identifying and prioritising level crossing safety issues and worthy of application in New Zealand.

During 2005 a series of surveys were carried out at 36 level crossings applying the ALCAM methodology. Further surveys were carried out on a number of level crossings in the busier rail corridors of Auckland and Wellington to assess the then recently developed ALCAM for pedestrian level crossings. The results indicated that ALCAM should be adopted in New Zealand. This view was endorsed by the Level Crossing Working group.

During 2008-2012 a programme of work, project managed by KiwiRail with shared funding between KiwiRail and the NZTA, has seen all public level crossings surveyed using ALCAM.

Over 200 level crossings have been upgraded using ALCAM as a design tool to identify risks and determine cost-effective treatments. This has occurred in the Waikato Region, in Auckland and in Wanganui, and has involved over 10 roading authorities. ALCAM has also been used as part of resource consent applications and to help assess applications to run heritage and tourist services.

New Zealand is an active participant in the ALCAM committee which oversees the ongoing maintenance and development of the model.

D4 Risk

Risk (effect of uncertainty on objectives) is widely known and accepted as the combination of both the *likelihood* (probability or frequency) of the occurrence of an event and the resulting *consequence* (outcome or impact) of that event once it has taken place. The risk management process follows the series of steps outlined in the International Standard ISO 31000:2009.

² Hughes, Peter *A risk assessment system for passive level crossings*, Seventh International Symposium of Railroad - Highway Grade Crossing Research and Safety, 20-21 February 2002, Melbourne, Australia, Monash University [2002].

Figure 1 ISO31000 risk management process

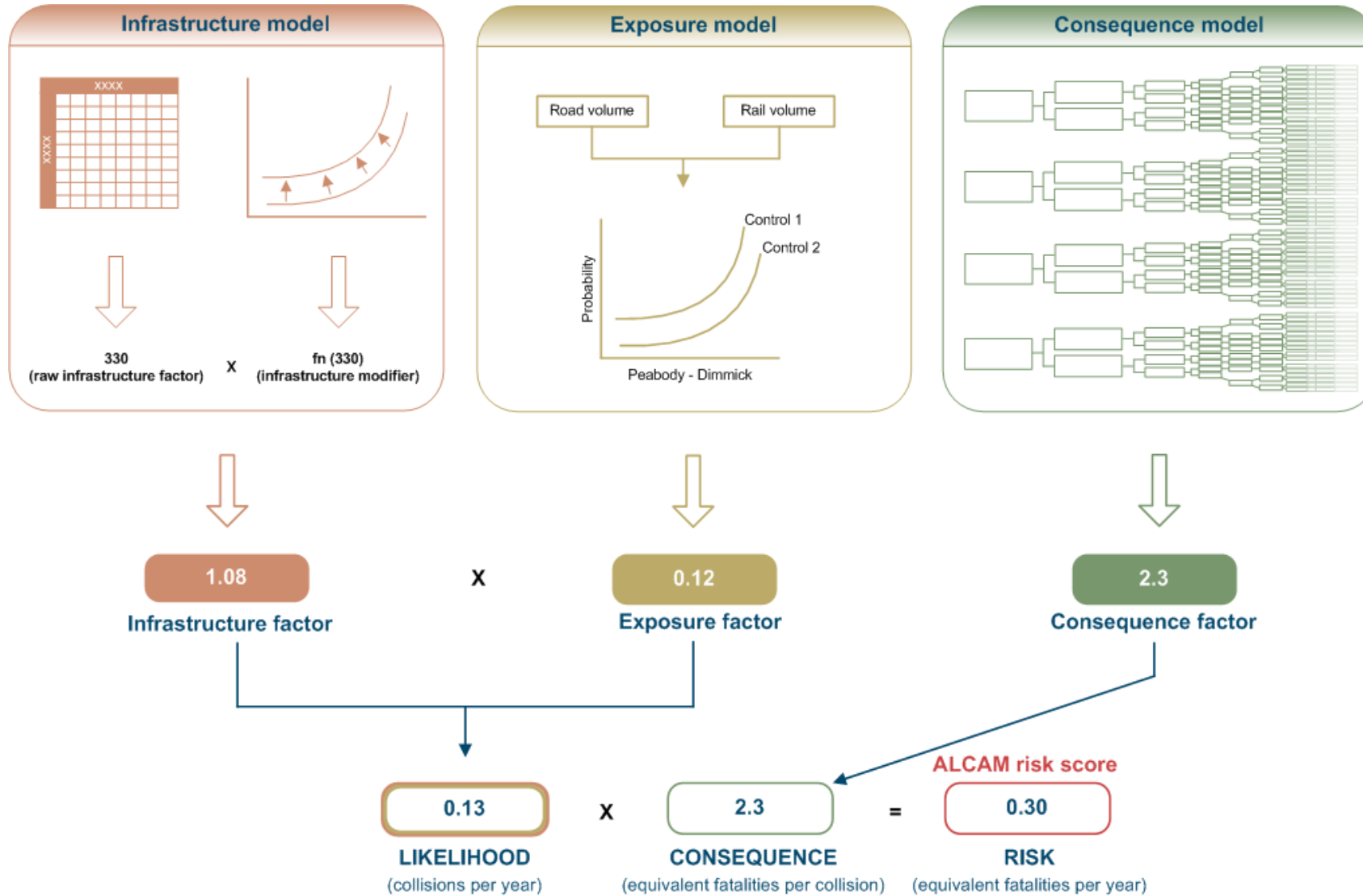

The risk evaluation process should consider all elements outlined in ISO 31000. It involves communication and consultation with a wide range of technical experts as well as the local stakeholders at individual level crossings. ALCAM is used to identify, analyse and evaluate the risks inherent at level crossings as well as giving a determination of the adequacy of proposed treatments for the risks. The model and the results produced from the model are regularly monitored and under a process of continual review and improvement.

ALCAM has a scope that is limited to the likelihood and immediate consequences of a collision at a level crossing. In accordance with the principles in ISO 31000, the user needs to appreciate the limitations of ALCAM and understand the wider external context in which the risks will be managed. This context could include a high-accident record at the site, key drivers of stakeholders and the wider consequences of an accident (ie risk to reputation, economic loss and consequential delay on the road, or rail network).

In line with safety risk modelling principles, ALCAM looks at risk from the viewpoint of consideration of loss (negative consequence) only as opposed to risk and reward (loss and gain). The model considers both qualitative and quantitative characteristics as well as assessing the impact of physical properties (characteristics and controls) including consideration of the related common human behaviours. The model allocates weightings to each characteristic in relation to how it would contribute to a collision and assesses what impact the existing controls would have on these characteristics.

D5 ALCAM process

The ALCAM process involves the collection of data through a combination of level crossing surveys, and train and vehicle information from the respective rail and road authorities. Each level crossing is assessed uniformly using a standardised procedure to gather and interpret level crossing data. Once the data is collected and entered into ALCAM, reports can be run to produce a priority listing, which can be used as the basis for determining safety improvement programs.

The user can then enter potential treatment options into ALCAM as proposals. ALCAM then models the relative reductions in risk and produces a treatment report. The proposals as outlined in this report are then discussed at a stakeholder meeting, where the highlighted hazards and proposed treatments are combined with any site specific hazards and treatments. This process ensures that level crossings are addressed on a consistent priority basis, appropriate and cost-effective treatments are chosen and that all safety hazards have been addressed.

The ALCAM process is represented graphically in [Figure 2 ALCAM process and outputs](#). This shows the flow of information through from data collection to model output, and illustrates how these feed into the stakeholder review and physical safety improvements.

Depending on the ALCAM risk score, infrastructure factor, stakeholder analysis of site specific features and any other influencing factors, decisions can then be made on the need for treatment or for the type of treatment. This may be in the form of state-wide upgrade programs or through a local review between road and rail stakeholders.

Figure 2 ALCAM process and outputs

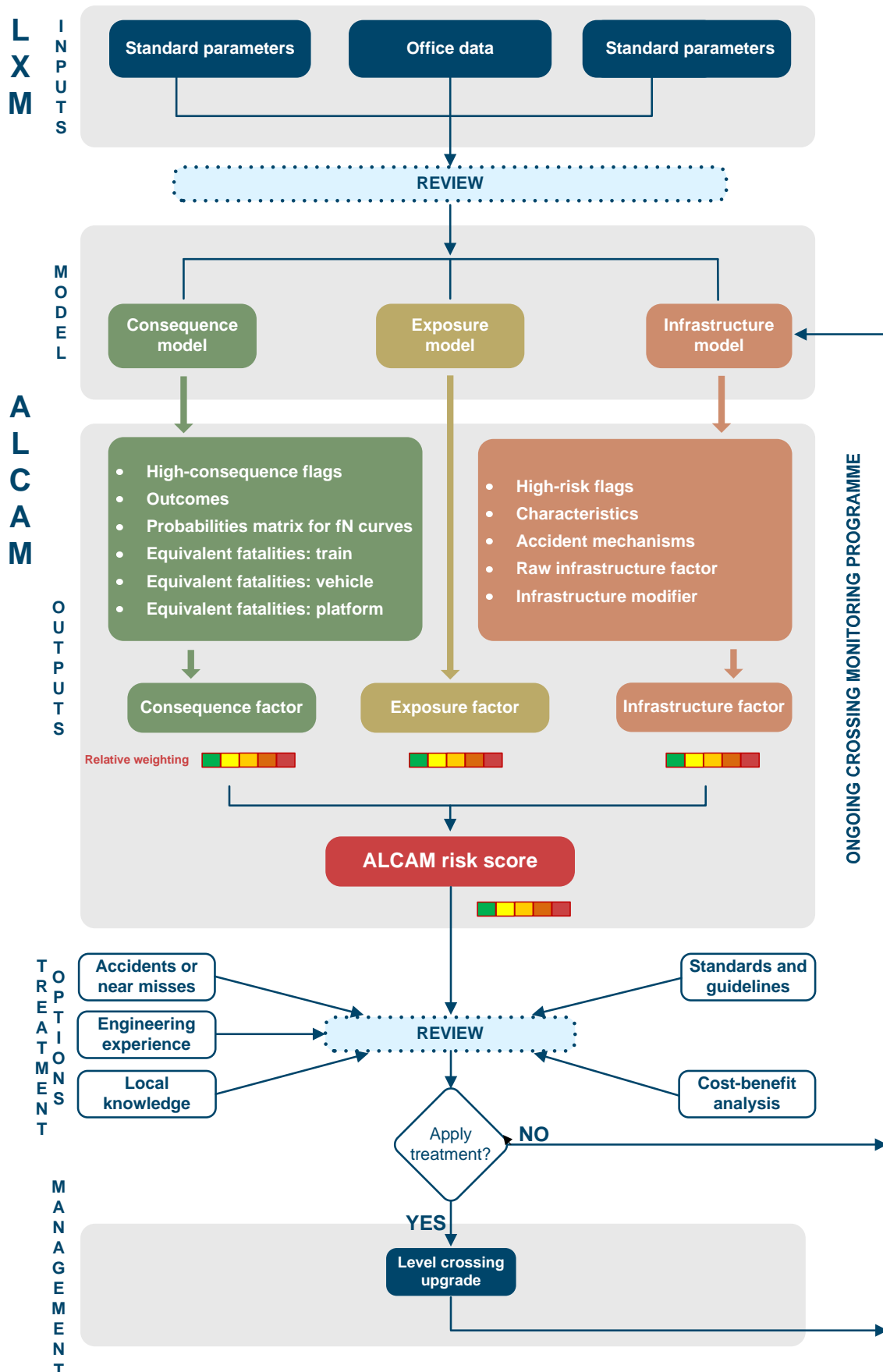

D6 Structure of the ALCAM model

The ALCAM model comprises of three separate components: the infrastructure model, the exposure model and the consequence model. Each of these models has a single factor as an output that, when combined, produces a risk score for each level crossing:

$$\text{ALCAM risk score} = \text{infrastructure factor} \times \text{exposure factor} \times \text{consequence factor}$$

The *infrastructure factor* is the output of a complex scoring algorithm that considers how physical properties at each site will affect human behaviours. This factor modifies the accident probability per year to reflect unique site conditions.

The *exposure factor* is a function of control type, vehicle (or pedestrian) volumes and train volumes. This is expressed as an accident probability per year. Multiplying the infrastructure factor by the exposure factor will give the actual annual probability of an accident at a particular level crossing.

The consequence factor is the expected outcome in the event of a collision and includes deaths and injuries on both the train and vehicle. This is expressed in terms of equivalent fatalities per collision. For pedestrian level crossings the consequence factor is fixed.

The *ALCAM risk score* is expressed in terms of an expected number of equivalent fatalities per year. An equivalent fatality is a combination of all types of harm using the ratio:

$$1 \text{ fatality} = 10 \text{ serious injuries} = 200 \text{ minor injuries}$$

The mechanics of the ALCAM model have been illustrated graphically in [Figure 3 Structure of the ALCAM model](#).

Figure 3 Structure of the ALCAM model

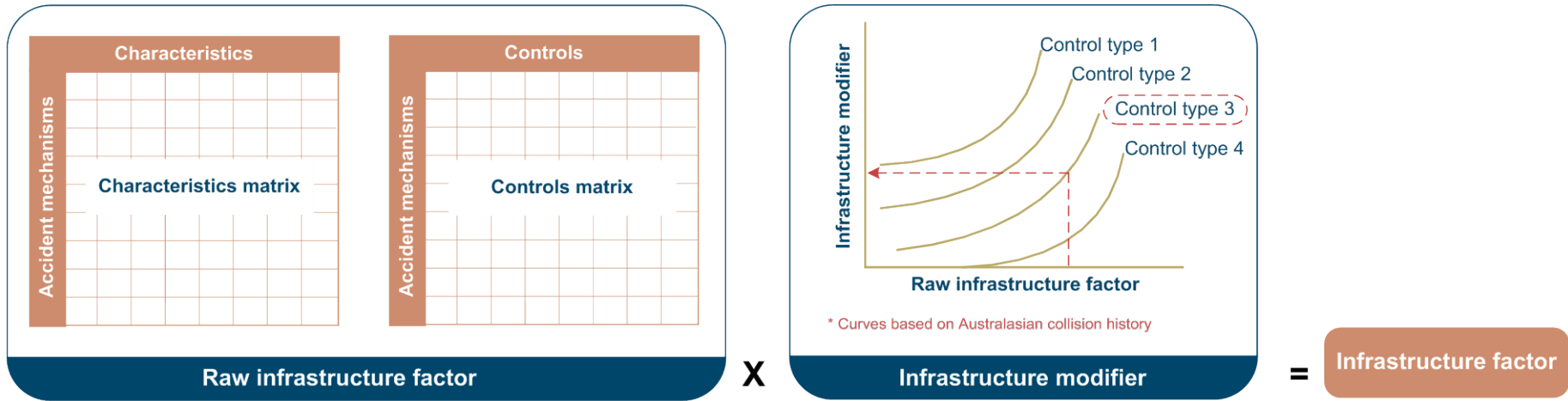

D6.1 Infrastructure model

ALCAM risk score = **infrastructure factor** x exposure factor x consequence factor

D6.1.1 Infrastructure factor

Infrastructure factor = raw infrastructure factor x infrastructure modifier

The infrastructure factor is expressed as a scalar which represents the expected effect that the site conditions will have on the accident probability.

As an example, a crossing with give way controls may have a raw infrastructure factor of 600. This is higher than the average, and therefore when multiplied by the infrastructure modifier for give way crossings it will produce an infrastructure factor of 1.35. This suggests that that poor site conditions will lead to a 35 percent increase in the accident risk over baseline conditions for a level crossing controlled by give way signs. The baseline conditions were established by comparing all raw infrastructure factors against 10 years of Australian and New Zealand accident data.

6.1.2 Raw infrastructure factor

Infrastructure factor = **raw infrastructure factor** x infrastructure modifier

The output from the matrix is a raw infrastructure factor score.

This number is made up of all site characteristics that contribute to the chance of a collision occurring, and all-site controls that reduce the chance of a collision occurring. It is an easy-to-follow number that is useful for comparisons between level crossings, but is not directly expressed as an accident probability. Although it forms only one part of the risk equation it can be used to identify higher risk crossings or specific deficiencies.

The raw infrastructure factor is a number between 0 and 800 that has been included since model conception and is familiar to most ALCAM users. The features that make up the raw infrastructure factor are discussed below.

Accident mechanisms

The main calculation engine within ALCAM involves a matrix of weightings relating to how much each nominated characteristics at a level crossing influences the potential accident mechanisms. Accident mechanisms are any significant pedestrian or driver behaviour that increases the potential for a collision with a train to occur. The model also determines the impact the existing controls would have on these accident mechanisms.

Significant and practical accident mechanisms, characteristics and controls have been considered and included through a process of seeking expert opinion through a series of workshops and interviews. The full listing of characteristics, controls and accident mechanisms for both road and pedestrian level crossings can be found in appendices C and D respectively.

Accident mechanisms have been grouped into the following categories:

- where the level crossing user is **unaware** of the dangerous situation
 - where the level crossing user is **unable** to avoid the dangerous situation
 - where the level crossing user is **unwilling** to recognise the dangerous situation.
-

Each of these mechanisms is then weighted based on a six by six probability matrix. A mechanism's weighting is calculated as the product of the occurrence and collision probability rating (weighting score between 1 and 36).

The *occurrence probability* is a measure of how often the accident mechanism is likely to occur. The *collision probability* is a measure of the likelihood of an incident if the accident mechanism does occur.

Characteristics and controls

A characteristic is defined as any feature of a roadway or railway which may have an influence on pedestrian or driver behaviour (accident mechanisms). Characteristics include items such as sighting distance, speed of trains, stacking distance, or the distance to adjacent intersections.

Controls are devices that reduce the risk of an accident by changing pedestrian or driver behaviour. These include measures such as flashing warning lights, boom gates, signage or improved road alignment. A control could also include education and law enforcement campaigns.

Weightings matrix

A matrix has been constructed to represent the effect each characteristic would have on each accident mechanism. Some characteristics may have no causal effect on a particular accident mechanism, whilst some may have a partial effect. If a characteristic is the only contributor to a given mechanism then the percentage weighting will be 100 percent. The total percentage effect for each mechanism must total 100 percent.

A similar matrix exists to determine the effect that controls will have on reducing the likelihood of an accident mechanism occurring.

Since the development of the original matrix, several workshops have been held to both add and remove accident mechanisms, characteristics and controls. The need for these changes has generally risen from concerns and recommendations raised by users of the model.

The current version of the matrix produces results, which have been shown to accurately reflect the current hazard profile at each site. This has been determined through a detailed analysis and comparison of the results of a number of sample sites across each of the major Australian states in combination with a review of model outputs against collision data.

Sensitivity

In the infrastructure model there are particular characteristics which have a greater influence on the overall risk profile at each level crossing. These characteristics include limited sighting of trains (at passive sites), limited approach sighting, queuing and short stacking, proximity to shunting yards and stations, high percentage of heavy vehicles and a hump or dip across the tracks.

It is these highly sensitive characteristics that have the greatest influence on whether or not a level crossing will be prioritised for safety improvement works. These highly sensitive characteristics are also flagged in the model output.

The high-sensitivity characteristics have all been validated against 10 years of Australian and New Zealand accident data (~2000–2009) using correlation techniques (ARRB (2011)) and multi-linear regression (ITSR, NSW (2011)). Some of the less sensitive characteristics do not appear to have a statistical influence in the collision records, and so have been down-weighted but still included in ALCAM.

6.1.3. Infrastructure modifier

Infrastructure factor = raw infrastructure factor x **infrastructure modifier**

To turn the raw infrastructure factor into a real accident probability it is necessary to multiply it by an infrastructure modifier. The infrastructure modifier is a linear equation that was determined by correlating 10 years of accident data against the raw infrastructure factors for all jurisdictions (normalised by vehicle and train volumes). There is a separate infrastructure modifier for each type of level crossing control and each infrastructure modifier is distributed around 1.

D6.2 Exposure model

ALCAM risk score = infrastructure factor x **exposure factor** x consequence factor

The exposure factor is a function of control type, vehicle volumes and train volumes. It represents the baseline likelihood of an accident at a level crossing, excluding site-specific conditions that are captured in the infrastructure model. The exposure factor is expressed as an accident probability per year.

In 2011, the ALCAM committee commissioned a study to assess the relationship between vehicle (V) and train (T) volumes in respect to the risk of an accident (ITSR, NSW (2011)). To do this, the study used 10 years of Australian and New Zealand accident data. Different exposure modelling approaches from Australia, UK, and USA were investigated and a 'logit' analysis of the combined accident data was carried out.

The report found that conventional linear approach (VxT) that was historically used in ALCAM did not best replicate the observed collision record. In addition, the type of control at the crossing was a critical factor in determining the expected collision rate.

The report recommended that ALCAM adopt the Peabody-Dimmick Formula, an exposure modelling approach that was first developed in 1941 and has been subsequently used in the USA.

Since 1941 road accident rates in general have decreased considerably. As a result the actual collision rates predicted by the Peabody-Dimmick Formula are an order of magnitude too high. This can be addressed by dividing the result by an additional factor, to produce more contemporary crash rate predictions. This has been done by many users of the formulation in the USA. The Peabody-Dimmick Formula is:

$$A5 = I_u + K$$

Where:

- $A5$ is expected number of accidents in five years
- I_u is the unbalanced accident factor
- K is additional parameter.

The unbalanced accident factor I_u is calculated by:

$$I_u = 1.28 \times (V^{0.170}) \times (T^{0.151}) / (P^{0.171}) \quad (6)$$

Where:

- V is the average volume of road vehicles over the crossing per day
- T is the average volume of trains over the crossing per day
- P is protection coefficient.

K is calculated from the chart shown below:

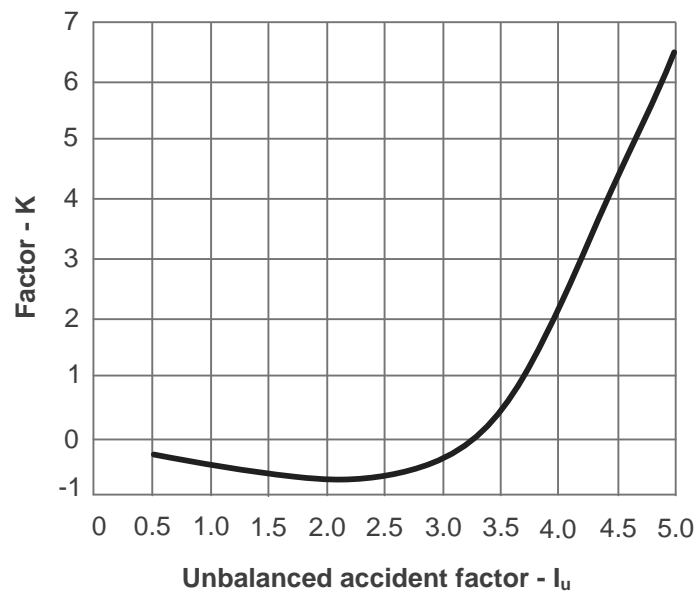

P was calculated on the basis of the combined Australian and New Zealand accident dataset, using a least squares fit with historical data curves for crash likelihood for road traffic and rail traffic. There is a unique P coefficient for each traffic control type (boom gates, flashing lights, Stop signs and Give Way signs). This ensures the formula is applicable to Australian and New Zealand conditions.

For pedestrian crossings the exposure is treated as a linear relationship (pedestrians x trains) and is independent of crossing controls.

D6.3 Consequence model

ALCAM risk score = infrastructure factor x exposure factor x **consequence factor**

The consequence factor is the expected outcome in the event of a collision and for road accidents it includes deaths and injuries on both the train and vehicle. This is expressed in terms of equivalent fatalities per collision.

The core component of the consequence model is an event tree that estimates the likelihood that a given level crossing collision will escalate into more serious consequences. This involves assigning probabilities to a sequence of events occurring. Hence the model produces a number of possible outcomes, each with an associated probability of occurrence.

Each outcome at the end of the branch has an associated number of fatalities, serious injuries and minor injuries. Using common Australian ratios, these are combined and expressed as equivalent fatalities. The event probabilities and outcomes are based on site conditions, overseas experience and historic derailment history. These have been compared against Australian and New Zealand accident data to help ensure that the model is realistic.

The model takes account of the whole range of possible occurrences to produce a single consequence factor. This represents the expected loss if a collision occurs. Note that the expected loss is not a worst-case scenario but is instead a combination of the lower-probability higher-consequence and the higher-probability lower-consequence events.

The consequence model records the full range of possible outcomes and the associated probabilities. If required, this can be used to produce F-N diagrams for an individual level crossing. F-N curves are a common risk assessment tool used in industries where an accident outcome can vary significantly (ie aviation). They are not commonly used by road authorities but are used far more widely in the rail industry.

There are a number of considerations in the event tree, including the:

- type of train including passenger and dangerous goods
 - type of road vehicle including dangerous goods and buses
 - probability of the train derailing
 - probability of the train colliding with infrastructure following a collision
 - probability of the train colliding with another train
 - headway between trains and time to secure the line
 - speed of the train
 - train loading or the number of passengers
 - emergency services response time
 - positions of station platforms, points, overbridges, tunnels, line-side structures and embankments
 - curvature of the track
 - possibility of release of dangerous goods
 - possibility of fire.
-

Because of the size of the event tree, it is split into one main tree with three sub-trees:

- Off-line derailment.
- Secondary collision.
- Dangerous goods involvement.

Each of the sub-trees is calculated multiple times via a macro and the results transferred to the main event tree. This enables the sub-trees to be calculated for a range of different inputs (ie different train speeds, dangerous goods involved, different train types, urban or rural).

For pedestrian level crossings the consequence factor is fixed at one effective fatality.

D6.4 ALCAM risk score

ALCAM risk score = infrastructure factor x exposure factor x consequence factor

The overall comparative score which is produced by ALCAM is called the ALCAM risk score. This number is a product of the infrastructure factor, exposure factor and consequence factor, and is expressed in terms of an expected number of equivalent fatalities per year.

It is this figure that allows comparison of level crossings against each other within a given jurisdiction based on the level of risk. By sorting level crossings in relation to their ALCAM risk score, a priority listing can be created which can then be used to assist in the development of safety improvement programs.

D7 Interpreting ALCAM output

D7.1 Relative ranking bands

To assist the user, the LXM system provides a number of tools to rank a level crossing against other level crossings in a given jurisdiction, or against all crossings in Australia and New Zealand. The ranking is expressed in a percentile and grouped in one of five categories (from bottom 20 percent to top 20 percent). The ranking is simply a tool to assist ALCAM users in understanding the relative risk of a particular crossing. It is not a warrant for upgrades and does not indicate a safe standard.

The relative rankings paint a picture about a particular level crossing. For example take a crossing with a Give Way control that is ranked in the following bands:

- Infrastructure factor: 80 - 100 percent (high)
- Exposure factor: 0 - 20 percent (low)
- Consequence factor: 20 - 40 percent (low-medium)
- ALCAM risk score: 0 - 20 percent (low).

These would highlight to the user that the crossing has very poor infrastructure. However, the low-exposure ranking suggests that very few trains and cars use the crossing. The low-medium consequence ranking suggests if an accident were to occur it is not likely to be a multiple fatalities, indicating the crossing is likely to have lower train speeds and unlikely to be used by buses or passenger trains.

Viewed in combination, the low ALCAM risk score would suggest that the authority would be better off focusing funds on other crossings with higher level of risk. However, the relative high-infrastructure factor should be a prompt to check if the crossing meets standard and if there are some quick improvements that can be made.

The modelling capacity of ALCAM allows the user to test various scenarios. In the example above, an extension of a passenger metro line over the crossing would significantly increase relative rankings of both the exposure and consequence factors. Hence the total ALCAM risk score would increase significantly. This may be a prompt for an authority to consider an upgrade to active controls.

7.2 Metrics used

Used in conjunction with each other, the infrastructure factor and exposure factor give a *probability of a collision* at a particular crossing. The probability at a crossing could be referenced in a number of ways, including collisions per movement, collisions per year, or collisions per 10 years.

The ALCAM consequence factor is expressed as *expected equivalent fatalities per collision*. This is a single number that is made up of the average of a number of different accident scenarios (each with a different probability of occurrence). LXM has the functionality to provide the user with output from the event tree analysis, allowing them to produce an F-N curve for more site-specific risk analysis.

The ALCAM risk score includes consequence and hence is expressed as *expected fatalities per year* (ie expected loss). The benefit of this is that this allows the user to build a quantitative business case for upgrades. This is typically required for most funding programs.

The ALCAM user still needs to be careful when treating level crossings in the same manner as road accidents. The risk profile of level crossings always contains the potential for lower-probability higher-consequence events (particularly where passenger trains are involved). In this sense, the rail risk profile could be argued to have more in common with the aviation industry and a strict reliance on historical accident records may not manage the risk appropriately.

The consequence model includes low-probability high-consequence events, however the model focuses on fatalities and injuries only. It does not include consequences such as reputational risk, infrastructure and rolling stock damage, legal liability, the risk of increased regulation, and the costs of line closure.

Hence a pure cost-benefit application of the ALCAM output may not be appropriate. A rail authority may determine that potential for low-probability but high-consequence events may warrant some crossings being provided with a higher standard of control. This would particularly be the case in urban areas and on busy rural lines that carry high-value freight.

7.3 Flags

There are particular hazards at level crossings which are identified for consideration regardless of the overall infrastructure factor or ALCAM risk score at the crossing. Flags are used to highlight specific characteristics or risks that may result in a situation an unacceptable situation (ie queuing, sighting and short stacking). ALCAM flags such areas of concern to allow further assessment to ensure they are not left unconsidered. A compliance flag is also included in relation to the requirements of the relevant Australian Standard AS1742.7.

D8 Treatment

Once the profile of a level crossing has been established, suitable safety improvements can be considered. ALCAM allows the user to run various proposed mitigation measures and examine the impact based on the theoretical reduction in overall and specific ALCAM risk scores.

It must be understood that active controls (flashing lights and boom barriers) are not always the best or most cost-effective answer, and the proposed mitigation should address the specific hazards at each level crossing. For example at a level crossing where short-stacking has been identified as the main hazard, the introduction of active controls such as boom gates may have little impact on the risk profile. A more suitable solution may involve changes to road infrastructure on the departure side of the level crossing or interfacing with adjacent road traffic controls.

It is also very important to ensure that all stakeholders associated with the particular level crossing are involved with the determination of the final recommended treatment. Although it is a comprehensive tool for the assessment of level crossing hazards, ALCAM cannot be applied in isolation. Any risk assessment and treatment also needs to consider other factors, including:

- collision and near miss history
 - engineering experience (both rail and road)
 - local knowledge of driver or pedestrian behaviour
 - standards and international best practice.
-

D9 Data management and LXM

The ALCAM model sits inside a total data management system known as LXM (Level Crossing Management). The LXM system contains a number of tools to assist users in the management of level crossings, including the ability to generate summary reports, model the effect of proposed upgrades and provide summary lists of level crossing deficiencies. Should jurisdictions choose to use it, LXM can act a data repository for other information such as incident history and digital photographs. An add-on package has been developed by the Victoria state, Australia to support interface agreements between rail and road organisations.

LXM currently runs on a Microsoft Access platform, with each jurisdiction hosting a stand-alone copy of the ALCAM model. In 2010, the ALCAM committee agreed to adopt a single database that would be accessed using an internet interface. This has the ability to support many more users, although each jurisdiction would still control the access to their own data. The new LXM platform is expected to be completed in late 2013.

D10 History of ALCAM

1999	<p>A project team was formed, part of its role was to establish a tool and technical guidelines for the assessment and treatment of level crossings and oversee the development of a database for level crossings. Prior to this project there was little evidence of a standard process whereby all level crossings were assessed in a consistent manner. The processes included a search of existing level crossing assessment tools which found a number of simple formula methods (eg Warren Henry Formula) which considered elements such as road/rail traffic volumes, number of railway lines, road grade/curvature, adjacent intersections and sun glare.</p> <p>Accordingly, the project team developed a risk scoring system referred to as the risk scoring matrix. This system provided a process for evaluating the risk score of a level crossing based on its existing characteristics and controls. It also enabled the identification of improvements to the risk score due to the implementation of selected controls and changes to characteristics.</p>
2002	<p>The project team identified that some modifications were required to improve the outputs of the risk scoring matrix. A national committee was established to ensure that the risk scoring matrix was used consistently and uniformly across the nation. The matrix was renamed the Australian Level Crossing Assessment Model (ALCAM) and the committee as the ALCAM group. Part of this committee's brief was also to develop a database that would enable the model to be used by all ALCAM members in the risk assessment of their level crossings.</p> <p>The ALCAM technical committee was commissioned as an ALCAM group subcommittee to further develop and improve the current risk assessment tool and to produce the first version of a national level crossing assessment tool.</p>
2003	<p>The ALCAM group initiated major reviews of both the vehicle and pedestrian assessment matrices by the ALCAM technical committee. In February, an independent review of the processes used to review ALCAM took place. During the 2003 Australian Transport Council (ATC) and SCOT (Rail Group) sanctioned that the ALCAM be adopted nationally. In addition, the Australian Railway Crossing Safety Implementation group (ARCSIG) was authorised to overview the ALCAM process of setting the standard for the vehicle and pedestrian matrices within ALCAM.</p>
2004	<p>Following a number of enhancements a new version of the ALCAM was released in May 2004. A Microsoft Access database was developed (LXM) as a useful tool for maintaining data and running assessments. It was adopted formally by the ALCAM group.</p>
2005	<p>A pedestrian level crossing matrix was added to ALCAM and issued in May 2005, and was subsequently incorporated in the LXM system.</p>
2006	<p>Favourable findings in a report received on the integrity of ALCAM and a determination of the legal position of ALCAM if challenged in court.</p> <p>Paper on ALCAM presented to the 9th International Trespass and Level Crossing symposium outlining the process and outputs.</p> <p>A series of flags introduced in ALCAM to highlight particular areas representing high levels of risk at level crossings and well as areas related to standards conformance.</p>

2007	<p>Changes made in ALCAM (especially in relation to sighting distance requirements) to align with the 2007 version of Australian Standard AS1742.7.</p> <p>New Zealand invited to join the National ALCAM group and commence collection data to use ALCAM.</p> <p>Work commenced on the development of a consequence event tree to replace the current simple consequence factor used in ALCAM.</p>
2008	<p>Structure changes made within ALCAM to ensure alignment with Australian and New Zealand Standard AS/NZ4360 the risk management standard.</p> <p>The ARRB Transport group was commissioned to carry out several projects including:</p> <ul style="list-style-type: none"> • a comparison between ALCAM and the UK model the All Level Crossing Risk Model (ALCRM) • an analysis of the relationship between ALCAM outputs and actual incident information • a review of the structure of ALCAM in consideration of its alignment with general risk principles.
2009	<p>Significant changes made to the terminology used in ALCAM to address issues raised by the National ALCAM group and reports commissioned into the models robustness, and alignment with general risk principles.</p> <p>ALCAM documentation and training material developed and training courses made more readily available to level crossing practitioners including contractors.</p> <p>Significant changes made to the LXM system to incorporate requirements of ARTC to use ALCAM across multiple states and as a higher security level.</p> <p>An ALCAM Weightings Workshop was held in Sydney to fine tune the matrix and to incorporate changes recommend above.</p>
2010	<p>Collection of accident data from Australia and New Zealand to validate the model and/or modify aspects as required.</p> <p>Agreed to redevelop the LXM system and move toward a single implementation accessed by each jurisdiction using a web interface.</p> <p>Development of consequence model using event trees.</p>
2011	<p>Project to correlate accident data against ALCAM output. Minor modifications to road weightings proposed for their model.</p> <p>Project to assess relationship between vehicles and trains in respect to the risk of an accident assess different exposure calculations. Proposed changes to use the Peabody-Dimmick Formula in the exposure model.</p> <p>Development of system specifications for the single implantation of the LXM system. New features added and opportunity taken to improve usability.</p> <p>Further development and verification of consequence model using event trees.</p>
2012	<p>Acceptance of new road weightings in the infrastructure model.</p> <p>Acceptance of Peabody-Dimmick Formula in the exposure model.</p> <p>Acceptance of the event tree analysis for the consequence model.</p> <p>Adoption of new naming conventions for the model components.</p>

D11 The future of ALCAM

ALCAM continues to be developed with fine-tuning of weightings, introduction of new level crossing control technology and modifications to the supporting LXM platform. All changes are approved by the National ALCAM group. There are a number of upcoming projects to further develop the ALCAM model, including:

- improvement of pedestrian model and associated LXM tools (likely completion 2015 +)
 - development of a single Australasian LXM system that is accessed using the internet (likely completion 2013).
-

References

References A: References

- ALCAM (2007) *Australian Level Crossing Assessment Model (ALCAM) technical manual v1.01*, National ALCAM Committee.
- ALCAM (2009) *Level Crossing Management System (LXM) technical manual* National ALCAM Committee.
- ALCAM (2009) *ALCAM on a page* National ALCAM Committee.
- ALCAM (2010) *ALCAM in detail* National ALCAM Committee.
- ALCAM (2011) *National ALCAM Committee charter* National ALCAM Committee.
- ALCAM (2012) *Policy on access to ALCAM* National ALCAM Committee.
- AS1742.7 (2007) *Manual of Uniform Traffic Control Devices – Part 7: Railway crossings* Standards Australia.
- Baker, Ross and Kieran Helm (2011) *Measurement of sight distances at level crossings*.
- ARRB Transport Group (2011) *Comparison of ALCAM and ALCRM models for rail level crossing risk assessment* Peter Croft and Blair Turner, Project VC74188.
- ARRB Transport Group (2009) *Risk advice on ALCAM* Philip Roper, Blair Turner, Dimitris Tsolakis, and Chris Jurewicz, Project VC74188-1.
- ARRB Transport Group (2010) *Correlation between ALCAM, crash factors and locations* Michael Levasseur, and Ben Mitchell, Project 002826.
- Creber and Associates (2004) *Review of Level Crossing Assessment Model Improvement Process (NSW)*.
- Creber and Associates (2003) *Review of Rail Infrastructure Corporation Level Crossing Assessment Model Process (NSW)*.
- Hughes, Peter (2002) *A risk assessment system for passive level crossings, Seventh International Symposium of Railroad-Highway Grade Crossing Research and Safety* 20-21 February 2002, Melbourne, Australia.
- Independent Transport Safety Regulator NSW (2008) *Review of processes for prioritising resources for the level crossing improvement program (LCIP)*.
- Independent Transport Safety Regulator NSW (2011) *Traffic flow and collision likelihood at Australian and New Zealand level crossings* Meiers, Simon and Hai Guo.
- Meiers, Simon (2012) *Proposal for incorporation of ALCAM likelihood factor into risk score*.
- Queensland Level Crossing Safety Project Team (1999) *Level crossing safety volume 1: Guidelines* Parts 1-9.
- Queensland Level Crossing Safety Project Team (1999) *Level crossing safety volume 2: Implementation* Parts 1-6.
- Queensland (2002) *Level crossing risk scoring matrix (VEH RSM5)* precursor to ALCAM
- Risk and Reliability Associates (R2A) (2006) *Due diligence review of the ALCAM road and pedestrian model, Report 173-26*, for Department of Transport (Victoria).
- Sotera Risk Solutions (2011) *ALCAM consequence model development* David Harris and Peter Dray, J1161/Doc001.

Reference B: Road level crossing – Model inputs and outputs

Level crossing characteristics

- Effectiveness of equipment inspection and maintenance
- Longest approach warning time
- Proximity to intersection control point
- Proximity to siding/shunting yard
- Proximity to station
- Possibility of short stacking
- Number of lanes or lines of traffic
- Vulnerability to road user fatigue
- Presence of adjacent distractions
- Condition of traffic control at level crossing
- Visibility of traffic control at crossing
- Distance from advance warning to level crossing
- Conformance with Australian Standards AS 1742.7
- Heavy vehicle proportion
- Level of service (vehicle congestion)
- Queuing from adjacent intersections
- Temporary visual impediments - sighting of level crossing or sighting of train
- Road traffic speed (approach speed 85th percentile)
- Train volume - two way (high /low)
- Seasonal /infrequent train patterns
- Slowest train speed at level crossing (typical)
- Longest train length at level crossing (typical)
- High train speed on approach to level crossing
- Number of operational rail tracks
- Condition of road surface on immediate approach/departure (not the crossing panel)
- Level crossing panel on a hump, dip or rough surface
- S1 - advance visibility of level crossing from road
- S2 - approach visibility to train (vehicle approaching crossing)
- S3 - visibility to train (vehicle stopped at level crossing)
- Sun glare affecting sighting of crossing or approaching train

Level crossing controls

- Grade separation
- Active control - half boom, flashing lights*
- Active control - full boom, flashing lights
- Active control - primary flashing lights*
- Flashing light enhanced stop sign
- Audible warning
- Passive control - stop signs*
- Passive control - give way signs*
- Passive control - position markers only
- Rail operated gates
- Keep tracks clear signs and cross hatching of crossing
- Backing boards /LED lights
- Enforcement camera
- CCTV surveillance
- Hand signaller (flagman)
- Public response phone number
- Reschedule train to avoid conflict
- Whistle board /location board for train
- Reduce train speed sign to achieve S2 or S3
- Street lighting at crossing
- Maintenance program for vegetation on rail
- Maintenance program for vegetation on road
- Extra lanes over crossing
- Central barrier posts/median on road approach
- Address short stacking - infrastructure

- Hump/dip advisory sign to road user
- R6-25 signage (confederate flag)
- Train speed advisory sign to road users
- Overhead-mounted (mast arm) traffic control
- RX-9 railway crossing width marker assembly
- Standard advanced warning (W7-4 or W7-7)*
- Train-activated advanced warning (eg flashing lights)
- Large passive advanced warning*
- Passive tactile advanced warning (eg rumble strips)
- Visual-road marking (stripes)
- Reduced speed zone in vicinity of crossing
- Rail-X pavement marking
- Localised public education strategies
- Address short stacking - alternate access
- Short-stacking sign
- Vehicle escape zones
- Control of crossing (CCTV or on-site)
- Coordination with adjacent traffic signal
- Sign (active) for downstream queue warning
- Sign (active) for second oncoming train warning
- Detectors in crossing conflict zone
- Road traffic signals (active)
- Variable message sign (active)
- Healthy state monitoring
- Queue relocation

* Additional weighting where control is duplicated on-site.

Accident mechanisms

The road user:

- is distracted
- cannot see control
- cannot see train from road approach (S2)
- cannot see train from at crossing (S3)
- assumes train would stop
- does not expect second train
- finds crossing control is ambiguous
- is fatigued
- is mislead by controls
- is unable to stop in time
- is stuck on tracks
- is stopped on tracks
- is queued on tracks
- overhangs on tracks
- is racing train or misjudged train speed
- drives through passive warning without looking
- drives through flashing lights
- drives around boom gates

Consequence model considerations

- Frequency of passenger trains
- Frequency of freight trains
- Frequency of freight trains (dangerous goods)
- Speed of passenger trains
- Speed of freight trains
- Speed of freight trains (dangerous goods)
- Percentage of buses
- Percentage of light vehicles
- Percentage of HGV vehicles
- Percentage of HGV vehicles (dangerous goods)
- Percentage of loco-hauled passenger trains
- Average bus occupancy
- Average passenger train occupancy
- Average freight train cab occupancy
- Average number of wagons per freight train
- Number of tracks
- Track straight or curved
- Distance to points or crossing
- Distance to platform
- Distance to under-bridge
- Distance to steep embankment
- Distance to medium embankment
- Distance to over-bridge or tunnel
- Time taken to protect fouled track
- Potential for derailment in a collision
- Potential for derailment offline in a collision
- Potential for secondary collision with another train

Reference C: Pedestrian level crossing – Model inputs and output

Level crossing characteristics

- Effectiveness of equipment inspection and maintenance
- Shortest approach warning time from start of flashing lights to when train arrives
- Longest approach warning time from start of flashing lights to when train arrives
- Presence of adjacent distractions (visual)
- Proximity to passenger station
- Proximity to siding/shunting yard
- Proximity to licensed or special event venue
- Proximity to school/playground or aged facilities
- Ambient noise level /audibility of alarm
- Adjacent road traffic activity
- Conspicuity of pedestrian control
- Visibility of pedestrian control
- Likelihood of vandalism to control
- Volume of pedestrians (peak flow)
- Type of pedestrians (children)
- Type of pedestrians (physically disabled)
- Type of pedestrian (sensory disabled)
- Type of pedestrians (intellectually disabled)
- Type of pedestrians (cyclists, wheelchairs, prams)
- Type of pedestrian (elderly)
- Train volume (pedestrian patience)
- Infrequent/seasonal movements/special trains
- Highest train speed at crossing
- Longest train length
- Number of operational rail tracks
- Angle of crossing and condition/width of flange gap
- Condition of crossing (fencing/path surface)
- Trains stand across crossing
- Gradients, widths and manoeuvring space of pathway/maze
- Change of path alignment between maze and panel
- Crossing to Australian standards (signage and path marking)
- Visibility from pedestrian hold point to train
- Sun glare issues at crossing
- Temporary visual impediments
- Masking of moving or stationary trains

Level crossing controls

- Grade separation
- Automatic gates
- Pedestrian booms
- Manual gates
- Maze
- Path
- No defined path
- Audible warning
- Visual alarm only
- Audible alarm only
- Visual and audible alarm
- Public education strategies
- Fault reporting number
- Supervising children
- CCTV (monitoring)
- Sign advising train speed
- Sign Crossing unsuitable for mobility devices
- Active sign Another train coming warning
- Holding line (painted only)
- Delineation line marking (painted only)
- Tactile ground surface indicators (TGSI)
- Advance warning signs for mobility devices/cyclists

- Signs only
- Unmarked crossing
- Rail operated gates
- Adjacent boom gates and audio
- Adjacent visual and audio
- Adjacent boom gates and lights
- Adjacent lights only
- Emergency egress with latch (including holding enclosure)
- Emergency egress without latch
- No emergency egress
- Hand signallers (flagman)
- Controlled crossing swing gates (CCTV or local signaller)
- Healthy state monitoring
- Police enforcement
- Path lighting at crossing
- Maintenance of vegetation
- Target boards/LED's
- Whistle boards
- Wing/funnel/guide fencing
- Funnel pathway
- Adjacent corridor fencing
- Change pathway alignment
- Flange gap filler
- Increase path width and trafficability
- Train lights
- Reduce train speed sign to achieve sighting requirements

Accident mechanisms

The road user:

- is distracted
- did not see train/visual warning signals
- did not hear train/audio warning signals
- has limited capacity to recognise danger and react
- is under the influence of alcohol
- does not recognise crossing
- does not expect second train
- assumes train would stop
- misjudges train speed
- does not expect train
- does not expect train movement(s)
- is misled by infrastructure
- is misled by controls
- is unable to stop in time/late recognition of danger
- is caught in tracks (stuck, slip, trip, fall)
- is unable to cross quickly enough
- is trapped by controls (if automatic gates)
- deliberately ignores control
- bypasses control
- crawls under wagons
- is skylarking

Reference D: ALCAM definitions and acronyms

General terms		
ALCAM	The Australian Level Crossing Assessment Model	
LXM	The Level Crossing Management system (platform for ALCAM, database and analysis tool)	
Organisations		
ATC	The Australian Transport Council Ministerial forum for Commonwealth, state and territory consultations and provides advice to governments on the coordination and integration of all transport and road policy issues at a national level	
NTC	National Transport Commission Lead transport regulatory reform nationally to meet the needs of transport users and the broader community for safe, efficient land transport policies, laws and practices	
RLCG	Rail Level Crossing Group Australian strategic group with a strategic objective to reduce the likelihood of crashes and near misses at Australian rail level crossings	
SCOT	Standing Committee on Transport under the Australian House of Representatives - oversees transport issues across New South Wales including those issues associated with railway level crossings	
Components of the ALCAM model		
Term	Found in	Description
ALCAM matrix	Infrastructure model	The matrix which represents the effect each characteristic and control has on each accident mechanism
Accident mechanism	Infrastructure model	An accident mechanism is any significant pedestrian or driver behaviour that increases the potential for a collision with a train to occur
Characteristics	Infrastructure model	A characteristic is defined as any feature of a roadway or railway which may influence on pedestrian or driver behaviour (accident mechanisms). Characteristics include items such as sighting distance, speed of trains, stacking distance or the distance to adjacent intersections
Consequence factor	Consequence model	The expected outcome in the event of a collision. This is expressed in terms of equivalent fatalities per collision
Consequence model	Consequence model	An event tree model used to produce a range of outcomes (and associated probabilities) if a collision were to occur. The average output of this model is the consequence factor
Controls	Infrastructure model	Equipment or tools that reduce the risk of an accident by changing pedestrian or driver behaviour. These include measures such as boom gates, signage, or improved road alignment. A control could also include education and law enforcement campaigns
Exposure factor	Exposure model	The annual accident probability for an average level crossing with a specified control type, vehicle/pedestrian volumes and train volumes
Exposure model	Exposure model	Non-linear calculations used to produce the exposure factor. The output of this model is the infrastructure factor
Flags	Infrastructure model	Particular hazards at level crossings which are identified for consideration (eg queuing and short stacking)

Infrastructure factor	Infrastructure model	A scalar to reflect how site conditions will increase or decrease the annual accident probability
Infrastructure model	Infrastructure model	An algorithm that considers how physical properties at each level crossing will affect human behaviours. The model includes characteristics, controls and accident mechanisms. The output of this model is the infrastructure factor
Infrastructure modifier	Infrastructure model	A number used to turn the raw infrastructure factor from an arbitrary number into a scalar that represents a change in the annual accident probability. This number comes from a calculation based on 10 years of Australasian accident records
Likelihood	Infrastructure model x Exposure model	The actual annual probability of an accident at a particular level crossing. This is obtained by multiplying the infrastructure factor by the exposure factor
Raw infrastructure factor	Infrastructure model	A number between 0 and 800 that reflects site conditions at a level crossing. The number is made up of all site characteristics that increase the chance of a collision, and all site controls that reduce the chance of a collision. Historically this was referred to as the ALCAM likelihood factor

Appendix E - Installation and maintenance responsibilities around level crossings

The following table provides a basic guide to the general responsibilities for carrying out physical works and does not reflect responsibility for funding this work. Funding arrangements should be agreed in writing between the rail provider and the RCA.

While every effort has been made to describe the responsibilities correctly, there may also be formal maintenance agreements, deed of grants or legal interpretations applying to a specific location, or asset that differ from the details below.

Installation and maintenance on many of the assets require cooperation between rail and RCAs. Significant risk reductions and cost savings through can be reached though coordinating these upgrade or maintenance activities. Note that the table below only applies to level crossings on public roads. The responsibilities for private level crossings are specified in individual deed of grants, or in legislation.

For all work within the rail corridor, the RCA is required to contact KiwiRail and obtain an access permit. Likewise KiwiRail is required to obtain permits and traffic management plans for any work outside of the rail corridor. Both RCAs and KiwiRail are strongly encouraged to waive application fees where the work being undertaken is in the mutual interest of both parties.

Asset	Responsible for		Comments
	installation	maintenance and operation	
Rail			
Rail track and associated infrastructure	Rail	Rail	
Road			
Kerb and channel along road	Road	Road	Where this encroaches within 5m of the rail, all kerb and channel to be done by RCA
Pavement within 5m of rail centreline	Road/rail by agreement	Rail	Railways Act 2005, section 83(1)
Pavement more than 5m from rail centreline	Road	Road	Railways Act 2005, section 83(1)
Structures			
Road-over-rail bridges	Road	Road	Railways Act 2005, section 83(2)
Rail-over-road bridges	Rail	Rail	Railways Act 2005, section 83(3)
Rail-road share bridge	Road-rail by agreement	Road-rail by agreement	Railways Act 2005, section 83(4)
Pier protection and pier graffiti removal on rail-over-road bridges	Road	Road	

Asset	Responsible for		Comments
	installation	maintenance and operation	
Crash protection barriers			
Longitudinal crash protection barriers	Road	Road	Includes the approach to level crossing and at road-over rail bridges
Other forms of end crash protection	Road/rail by agreement	Road/rail by agreement	Includes crash cushions and bollards
Within rail corridor for protection of alarms	Rail	Rail	
Vegetation and fencing			
Fencing along the rail corridor	Landowner	Landowner	Rail operators are not required to build or maintain fences (Fencing Act 1978, section 3(1))
Clearing vegetation within rail corridor	Rail	Rail	To maintain sightlines for operational reasons
Clearing vegetation within road reserve	Road	Road	To maintain sightlines
Clearing vegetation on adjoining properties	Landowner	Landowner	To maintain sightlines. Clearing of vegetation may be done under the direction of rail
Traffic control devices			
Level crossing alarms and barriers	Road/rail by agreement	Rail	
Traffic signals linked to level crossing alarms	Road/rail by agreement	Road	Road responsibility is up to rail signal control box
Signs in advance of level crossing	Road	Road	As defined in section 4.4 Signs used in advance of level crossings
Advance variable traffic signs activated by train	Rail-road by agreement	Rail-road by agreement	
Signs at the level crossing or within rail corridor	Rail	Rail	As defined in section 4.3 Signs used at level crossings RCA involvement is required to implement local traffic bylaw and change approach signs and road markings (Railways Act 2005, section 81(2))
Height clearance signs and devices on rail-over-road bridges	Road	Road	
Road and pavement markings	Road-rail by agreement	Road	As defined in section 5.0 Road marking . Includes yellow box markings

Asset	Responsible for		Comments
	installation	maintenance and operation	
Alternative passive warning devices on approach to level crossings	Road/rail by agreement	Road	Includes rumble strips or other trial technology
Alternative active warning devices on approach or at level crossing	Road/rail by agreement	Road/rail by agreement	Includes actively controlled pavement markers, signs or other trial technology
At grade pedestrian level crossings and cycle facilities			
Active pedestrian alarms	Rail	Rail	
Footpath more than 5m from rail centreline	Road/rail by agreement	Road	
Footpath within 5m of rail centreline	Road/rail by agreement	Rail	Hold line may be used as boundary where agreed
Pedestrian signs	Rail	Rail	
Mazes and fencing at level crossing	Road/rail by agreement	Road	As defined in section 8.0 Requirements for pedestrian and cycle level crossings
Street lighting or illumination at the level crossing	Road	Road	As defined in section 8.0 Requirements for pedestrian and cycle level crossings
Pavement marking and tactile pavers	Road	Road	As defined in section 8.0 Requirements for pedestrian and cycle level crossings
Street lighting			
Street lighting at the level crossing	Road	Road	
Services - Utilities			
Aerial cabling over rail section of road reserve	Asset owner	Asset owner	Rail responsible for access licences and leases within rail corridor
Water, gas, electricity and petroleum	Asset owner	Asset owner	Rail responsible for access licenses and leases within rail corridor
Drainage gullies and open drains on rail corridor	Rail	Rail	
Pipeline or culvert under rail line where it forms part of a stormwater or sewerage drainage system	Road or drainage authority	Road or drainage authority	Railways Act 2005, section 74
Other drainage pipelines or culverts under rail line	Rail	Rail	