

Overdimension vehicles and loads

This factsheet summarises the 'overdimension' requirements of the Land Transport Rule: Vehicle Dimensions and Mass 2016.

Please refer to factsheet 13 to determine if your overdimension vehicle or load still requires an overdimension permit. If it does require a permit, follow the steps in this factsheet.

If the load is divisible and you are not over the width or height limits, you may be eligible for a high productivity motor vehicle permit; refer to factsheet 13g.

What is an overdimension vehicle or load?

An overdimension (or oversize) vehicle or load is one that exceeds one or more of the maximum dimensions allowed for *standard* vehicles.

If you need information on the maximum sizes for *standard vehicles*, see factsheet 13 for definitions and general information, and see other factsheets in the factsheet 13 series for the information specific to your vehicle or your vehicle combination. If you need help call our contact centre on 0800 699 000.

Overdimension vehicles or loads are only allowed to operate on an overdimension permit if they are *indivisible*. (An *indivisible* load is a load that without an unreasonable amount of effort or expense, or the risk of damage to the load can't be divided into two or more sections for road transport.)

Construction machinery that is carried on an overdimension permit should be loaded so it fits within standard dimension limits, if possible.

There are special operating conditions that overdimension vehicles or loads must meet, based on the size of the vehicles and loads. There are four size categories - 1, 2, 3 and 4 - each larger than the previous one. This factsheet concentrates on the most common, Categories 1 and 2.

If you need information on Category 3 or 4 overdimension vehicles and loads, please contact the Overdimension Permit Issuing Agency (OPIA) - 0800 OVERSIZE (0800 683 774) or fax 06 953 6313.

Note: You need to contact your nearest NZ Transport Agency office if your load is overweight — that is, exceeds the mass (weight) limits in factsheet 13, *Vehicle dimensions and mass*.

What are the types of overdimension vehicles and loads?

Standard-sized motor vehicles carrying overdimension loads

Example: A rigid truck that doesn't normally exceed the standard dimension limits but is being used to transport an overwidth tank or long load.

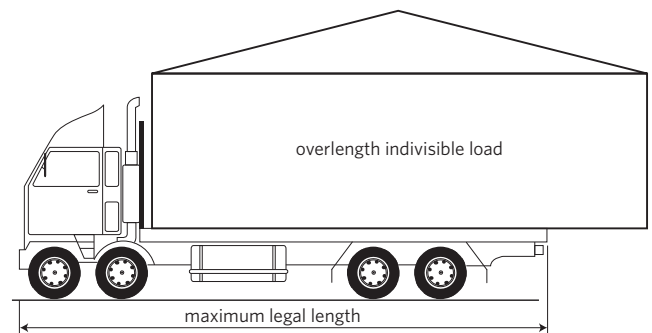

A standard motor vehicle may be used to transport an overdimension load provided that the load is indivisible, and is loaded in a way that minimises its width. (Unless the load's height or instability, or both, makes it necessary to transport the load sideways).

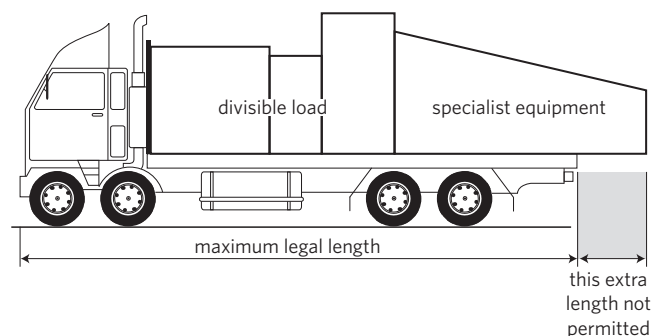

A standard motor vehicle may transport more than one overdimension load, if the loads:

- aren't wider than 2.55 metres if they're loaded side by side
- aren't higher than 4.3 metres if they're loaded one above the other
- aren't longer than the standard length or rear overhang limits for that vehicle if they're loaded one behind the other.

The following combination motor vehicles can't exceed the load standard rear overhang or overall length limits:

- A truck and simple trailer
- A truck and full trailer
- An A-train truck.
- A B-train truck.

Specialist overdimension vehicles

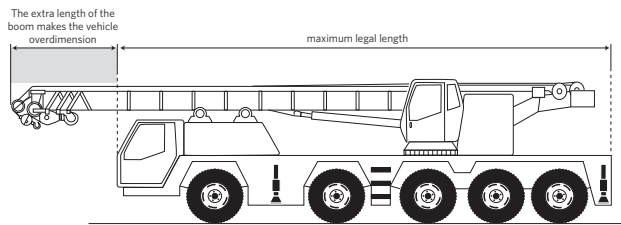

Example: Chip spreaders, forklifts, mobile cranes, snow ploughs, ground spreaders/sprayers etc.

Specialist overdimension vehicles aren't primarily designed to transport overdimension or overweight loads, but they can exceed the limits for standard vehicles if:

- the vehicle's primary purpose is to carry out a specialist function that requires overdimension equipment, and dismantling the vehicle's overdimension equipment would make the vehicle unusable for its intended purpose, or
- it would take more than four hours to dismantle the equipment.

A specialist overdimension motor vehicle may transport a divisible load, but it can't exceed the maximum standard dimension limits if those limits can be complied with by reducing

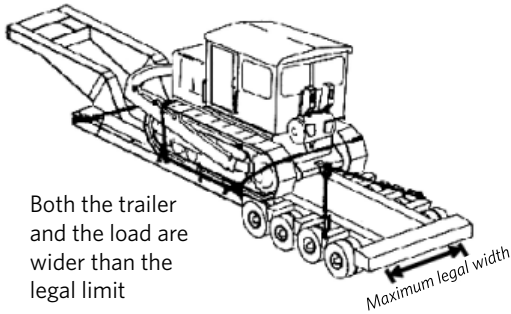

Both the trailer and the load are wider than the legal limit

the size of the vehicle's divisible load.

Overdimension vehicles designed for overdimension or overweight loads

Example: Low loaders, three or four rows of eight transporters, multi-axle house trailers, platform trailers.

The following three scenarios show how these vehicles, commonly referred to as *overdimension transporters*, can be loaded.

1. Overdimension transporter carrying overdimension load

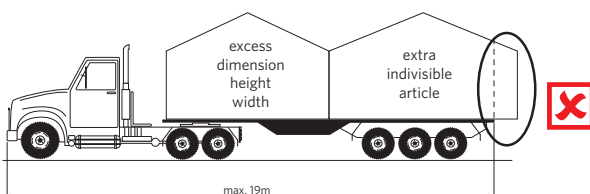
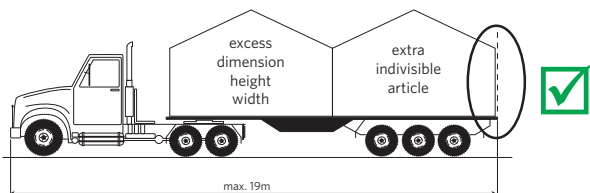

An overdimension transporter can carry an overdimension load if the load:

- is indivisible, and
- is loaded in a way that minimises its width (unless the load's height or instability (or both) makes it necessary to transport the load sideways).

An overdimension transporter may transport more than one overdimension load if:

- side by side, the total width isn't greater than 2.55 metres
- one above the other, the total load isn't higher than 4.3 metres
- one behind the other, the length, front overhang or rear overhang limits of a standard vehicle aren't exceeded.

2. Overdimension transporter carrying divisible load (general freight) only

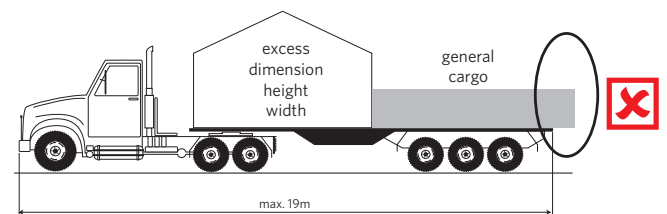
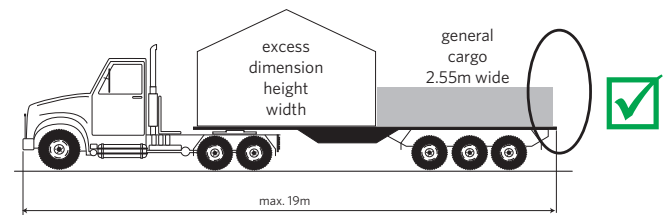

If an overdimension transporter is carrying an overdimension load and a divisible load (general freight), the overdimension transporter must be reduced to the smallest dimension practicable to carry the indivisible load.

This means that widening trailers must be closed to their narrowest width, and tromboning trailers must be reduced to their shortest forward distance.

Overdimension transporters may transport divisible goods if the goods:

- side by side, don't overhang the deck and the deck has been reduced to its smallest width
- one above the other, aren't higher than 4.3 metres, and
- one behind the other, don't overhang the deck and the deck has been reduced to its shortest length.

3. Overdimension transporter carrying divisible load (general freight) only

If an overdimension transporter is only carrying a divisible load (general freight) (ie, it isn't transporting an overdimension load), the transporter must be reduced to the smallest dimension practicable. Widening trailers must be closed to their narrowest width, and tromboning trailers must be reduced to their shortest forward distance.

An overdimension transporter may transport divisible goods if:

- one direction of the vehicle's journey requires the overdimension vehicle to transport an overdimension load, or
- the weight or instability of the divisible load requires the use of the overdimension motor vehicle.

If the two points above are true, then the three points below must also be met:

- Side by side, the goods don't overhang the deck and the deck has been reduced to its smallest width, and
- One above the other, the goods aren't higher than 4.3 metres, and
- One behind the other, the goods don't overhang the deck and the deck has been reduced to its smallest length.

Note: You cannot use a specialist overdimension trailer to carry divisible general freight that is not overdimension unless you have an overdimension load in the other direction.

General operating requirements that apply to all overdimension vehicles

If you want to drive an overdimension vehicle along a certain route, you should be sure your vehicle can fit along the proposed route before starting out. Drive along the route in daylight in a standard-sized vehicle first, checking for places where the overdimension vehicle may find it difficult to pass. If you intend to carry a high load, look out for overhead wires, signs, lights, trees, bridges and tunnels.

Damage

An overdimension vehicle must not interfere with or damage any traffic control device, bridge, tunnel or other structure (including wires, cables, banners or any other lawful construction). It must not damage trees or other foliage without the permission of the owner. If a traffic sign has to be moved so the vehicle can safely pass, the sign must be correctly replaced immediately afterwards. The operator of the overdimension vehicle is responsible for any damage.

Consideration for other road users

An overdimension vehicle must be operated with due consideration for other road users. Other road users must be allowed to pass the vehicle at the earliest safe opportunity.

Lighting during the day

When travelling during daylight hours, overdimension vehicles must have their headlights on low beam.

Overdimension vehicles must display an amber beacon when travelling on road if they're more than 3.7 metres wide.

Overdimension vehicles must display an amber beacon if they're being piloted by a pilot vehicle.

Lighting during the hours of darkness

When travelling during the hours of darkness, all overdimension vehicles must be clearly visible (in clear weather) from at least 200 metres away.

Overdimension vehicles, except a standard motor vehicle carrying a load up to 2.7m wide that is not overlength, must display an amber beacon.

If a load is being carried, except for a standard motor vehicle carrying a load up to 2.7 metres wide that is not overlength, there must be steady white or amber lights at the front and steady red or amber lights at the rear. These lights must have an area of at least 50 square centimetres and be positioned so approaching traffic can determine the size of the load and safely get past it. If the load overhangs the deck of the vehicle sideways, these lights

must be spaced approximately 1 metre apart across the lowest part of the load and at the widest parts of the load.

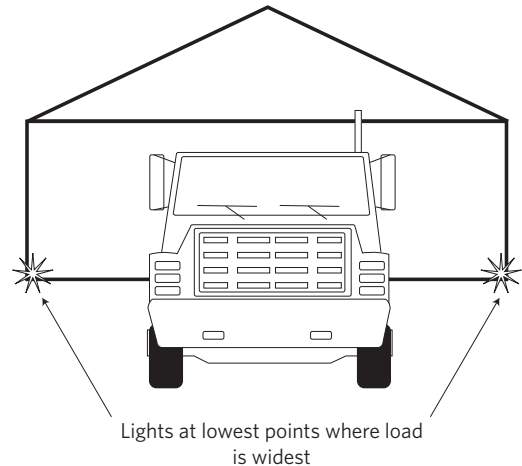

Overdimension vehicles, except a standard motor vehicle carrying a load up to 2.7 metres wide that is not overlength, must have side marker lamps spaced approximately 3 metres apart – amber colour to the front and red to the rear.

Visibility

An overdimension vehicle must not travel on a road if fog, heavy rain, hail or other factors restrict visibility to less than 350 metres. If visibility reduces to less than 350 metres after the journey starts, the vehicle must stop clear of moving traffic as soon as possible, and stay there until visibility improves (ie, more than 350 metres).

Alerting emergency services

The operator of an overdimension vehicle must notify local emergency service personnel in any area where the vehicle or its load is likely to restrict a route in a way that would significantly delay emergency services.

Route restrictions

- The Transport Agency website provides up-to-date road conditions and route restrictions for all motorists, please refer to www.nzta.govt.nz/traffic/current-conditions/index.html. In addition to these general restrictions an overdimension vehicle must: where available, use a route designated by a road controlling authority as suitable for overdimension vehicles, and
- comply with the following specific route restrictions and any other route restrictions that apply to the route the vehicle takes. (Some road controlling authorities have bylaws that restrict the use of some roads by overdimension vehicles. Contact the Transport Agency or the local council for more information.)

Auckland Harbour Bridge

Maximum height 4.8m. A vehicle exceeding 3.1m in width must contact the Traffic Operations Centre and may travel on this route provided it is accompanied by a Class 1 Pilot Vehicle as authorised by the Traffic Operations Centre.

Auckland Motorways

No travel on Auckland motorways if the width exceeds 3.1m or the height exceeds 4.3m except for the following:

- State Highway 1 between Ramarama Interchange (Ararimu Road Underpass) and the southern end of the Auckland Southern Motorway:
 - may be used by vehicles that exceed 3.1m in width but are less than 4.8m in height, and
 - may be used by vehicles that exceed 4.8m in height, if permission is first obtained from the Transport Agency.
- State Highway 18 between the intersection with SH16 and the Old Albany Highway:
 - may be used by vehicles that exceed 3.1m in width but are less than 4.8 m in height, and
 - may be used by vehicles that exceed 4.8m in height, if permission is first obtained from the Transport Agency.
- Auckland Northern Motorway between the Silverdale interchange and the northern end of the Northern Motorway:
 - may be used by vehicles that exceed 3.1m in width but are less than 4.8m in height, and
 - may be used by vehicles that exceed 4.8m in height if permission is first obtained from the Transport Agency.

Wellington Motorway

Maximum height 4.8m, maximum width 3.7m. However, an overdimension motor vehicle exceeding these dimensions may travel on the Wellington Motorway provided it complies with the Transport Agency's conditions.

Lyttelton Tunnel

Maximum height 4.27m, maximum width 2.6m, towing vehicle and semi-trailer maximum length 23m, 2m maximum for load overhanging front or rear of vehicle. However, overdimension vehicles exceeding the above maximums may travel if the following conditions are met:

- the operator of the overdimension vehicle must obtain permission from the Transport Agency (through Tunnel Control), and
- the operator of the overdimension vehicle must comply with any piloting or travel time restrictions required by Tunnel Control.

Toll Routes

Loads that exceed 3.1m width or 4.3m height are not permitted to travel on any toll route unless the Agency has provided explicit authority to do so. The operator of the overdimension vehicle must comply with any piloting or travel time restrictions required by the Transport Agency.

What are the overdimension operating requirements for excess height?

If your vehicle or load exceeds 4.3 metres in height, you must comply with these conditions.

Height (m)	Operating conditions
Greater than 4.3 - up to and including 5	<ol style="list-style-type: none">Written permission from the owner of an overhead obstruction that the vehicle travelling underneath cannot clear.Written approval from the relevant access provider, if the vehicle travels over a level crossing that does not cross a State Highway, and the vehicle exceeds the height shown on an electrified railway safe height sign.For loads exceeding 4.8 m, a vehicle with a deck height less than 1.3 m above the road must be used.
Greater than 5 - up to and including 6.5	<ol style="list-style-type: none">Need to meet all of the above operating conditionsNeed a permit from OPIAA vehicle with a deck height less than 1.3 metres above the road must be usedNeed written permission from the owner of overhead wires or cables that the vehicle travels under
Greater than 6.5	<ol style="list-style-type: none">Need to meet all of the above operating conditionsNeed written approval from the Transport Agency: Apply to OPIA.

* To contact OPIA's helpdesk phone 0800 683 774 or fax 06 953 6313.

The operator is responsible for making sure there are enough pilots to manage the excess height. This will depend on what traffic management (if any) is needed to get around overhead obstructions.

Overdimension requirements for excess length

The operator of a vehicle that is more than 25 metres long has to get written permission from the rail service operator if the vehicle is going to travel over a level crossing.

If the overdimension vehicle is transporting a load more than 30 metres in length, it has to have a rear steering facility.

If an overdimension vehicle has an operated steering jinker or a pole trailer, the rear overhang is measured between the centre of the rear turntable load support and the rearmost part of the load.

If the vehicle combination includes a load-sharing trailer, the load-sharing trailer does not have to be included in forward-distance calculations if the forward distance is 3.5 metres or less. If the forward distance exceeds 3.5 metres, this distance must be added to the forward distance of the main trailer, less 3.5 metres.

If the vehicle combination includes an operated steering jinker, the forward distance used for determining the overdimension operating requirements is half the distance between the two turntables supporting the load.

How can I work out the category of my vehicle?

The operating requirements for overdimension vehicles depend on their width, length, forward distance, front overhang and rear overhang and height.

The graph below shows which category your vehicle and load fall into, based on the width and forward distance (read the factsheet 13 series if you don't know how to calculate forward distance).

Determining category, based on width and forward distance

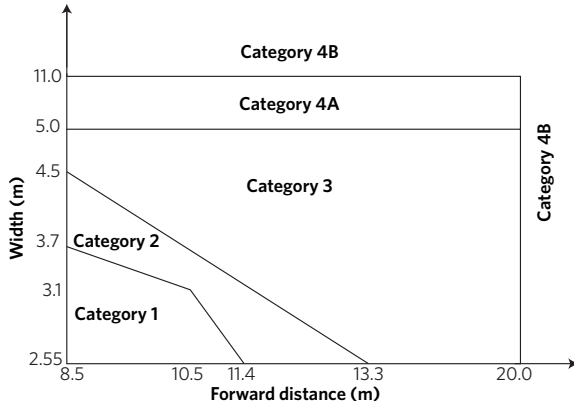

Find the horizontal line on the graph that matches your vehicle's width, and the vertical line that matches your vehicle's forward distance. Where these two lines meet determines your category. (Work out the category for each vehicle in a combination, and follow the requirements for the highest category vehicle.)

Width and forward distance are only two of the five dimensions that determine if your vehicle or load is overdimension. Your vehicle or load will also fall into Category 1 if:

- the length is over the maximum allowed for a standard vehicle (including combination vehicles), but not over 25 metres, or
- the front overhang is over the maximum allowed for a standard vehicle, but not over 7 metres, or
- the rear overhang is over the maximum allowed for a standard vehicle, but not over 7 metres.

Read the factsheet 13 series if you don't know the maximum values allowed for standard vehicles.

Your vehicle or load will fall into Category 2 if:

- the length is more than 25 metres but not more than 35 metres, or
- the front overhang is more than 7 metres but not more than 10 metres, or
- the rear overhang is more than 7 metres but not more than 10 metres.

If any dimension falls into Category 1 (and none in Category 2) then your vehicle falls in Category 1. Any dimension falling into Category 2 (and none in Category 3) puts your vehicle in Category 2.

If the vehicle or load is more than 35 metres long, or has a front overhang or rear overhang of more than 10 metres, then it falls in Category 3 or 4 and you need to contact OPIA.

Combinations falling on the upper boundary of Category 1 on the graph are treated as Category 1 loads, and those falling on the upper boundary of Category 2 on the graph are treated as Category 2 loads.

Do I need an overdimension permit?

An overdimension vehicle or load must have an overdimension permit, unless:

- its width and forward distance combination are within Category 1 or 2 limits, and
- it's no higher than 5 metres, and

- it doesn't have a front overhang or rear overhang greater than 7 metres, and
- it isn't longer overall than 25 metres.

If your vehicle exceeds any of these dimensions, or has a width and forward distance combination that falls within Category 3 or Category 4 areas of the graph, then you must obtain a specific permit from OPIA (phone their helpdesk on 0800 OVERSIZE (0800 683 774) or fax 06 953 6313).

If they grant you a permit, you have to carry it in the vehicle when you're travelling, and produce it for inspection by an operator of a pilot vehicle or an enforcement officer.

What are the operating requirements for Category 1 and Category 2 vehicles?

The operating requirements set out here are minimum requirements. Regardless of the size of the vehicle, the operator of an overdimension vehicle must ensure the vehicle can safely complete its journey.

In particular, this will require adequate clearance along the route, and the vehicle being able to safely share the road network with other vehicles. The operator must ensure pilot vehicles accompany the vehicle in any areas where it is necessary to provide adequate warning and traffic management to approaching traffic.

Category 1 requirements

These requirements are in addition to the general operating requirements.

Hazard warning markings and signs

Fluorescent yellow flags (at least 400mm long and 300mm wide) must be attached to indicate the:

- excess width of the vehicle or load at its front and rear
- front of the load (if it has excess front overhang)
- rear of the load (if it has excess rear overhang)
- rear of the load (if it has excess length).

You may use retro-reflective hazard panels coloured yellow-green with an orange diagonal stripe instead of flags.

If you're travelling during the hours of darkness, the flags must be replaced with retro-reflective yellow-green hazard panels with an orange diagonal stripe.

Hazard panels

The panels must:

- comply with AS/NZ 1906.1: 2007 *Retro reflective materials and devices for road traffic control purposes, Part 1: Retro reflective materials*
- consist of retro-reflective material coloured yellow-green with either a 200mm- or 300mm-wide diagonal orange stripe
- have the illustrated dimensions and orientation
- be frangible (breakable or readily deformable) if any part of the hazard warning panel extends beyond the body of the vehicle or the load, whichever it is attached to.

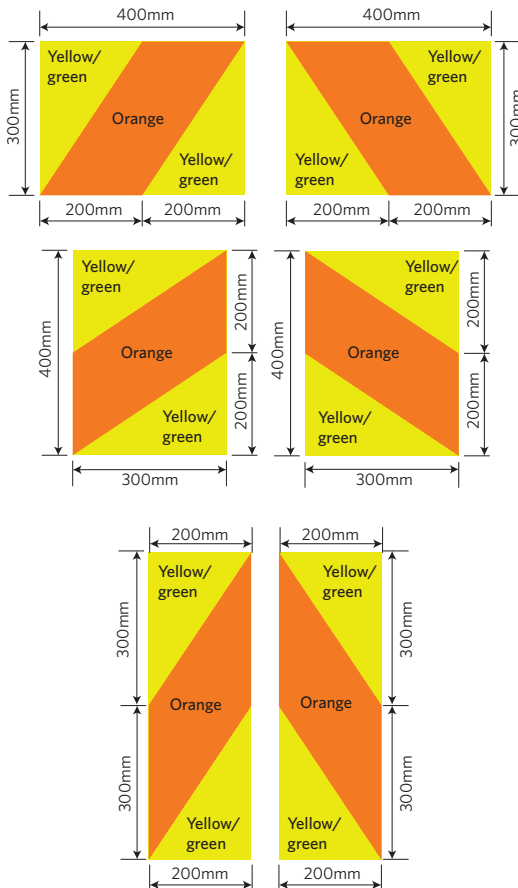

If the vehicle is more than 3.1 metres wide, Oversize signs must be displayed at the front and rear.



You must not display Oversize signs unless required to do so by the Vehicle Dimensions and Mass Rule.

Piloting

If the width of the vehicle or load exceeds 3.1 metres and the vehicle travels during the hours of darkness, the overdimension vehicle must be piloted by at least one Transport Agency-approved Class 2 pilot.

If the width of the vehicle or load exceeds 3.1 metres and the vehicle travels at a speed over 40km/h, the overdimension vehicle must be piloted by at least one Transport Agency-approved Class 2 pilot.

For a convoy of up to three agricultural motor vehicles that are travelling in company and all have dimensions within Category 1, it is sufficient to have one pilot vehicle at the front of the convoy and one pilot vehicle at the rear of the convoy.

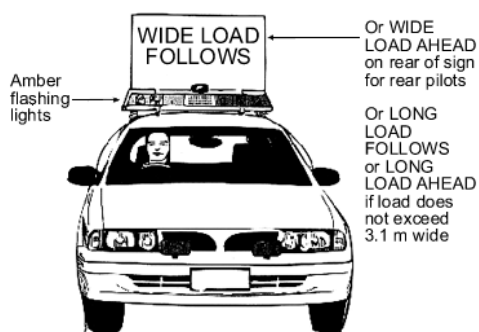

Restricted travel times

Category 1 overdimension vehicles must not travel:

- between 0700 hours and 0900 hours, or 1600 hours and 1800 hours, on Monday to Friday inclusive, in any city* area
- between 1000 hours and 1300 hours, or 1600 hours and 1900 hours, on Saturday or Sunday
- at times when there are unusually heavy traffic volumes.

* **Note:** City is defined as the urban areas of Auckland (between Albany and Drury), Christchurch, Dunedin, Hamilton, Hastings, Invercargill, Napier, Nelson, New Plymouth, Palmerston North, Tauranga, Wanganui, Wellington (including all areas south of McKays Crossing on State Highway 1 and Te Marua on State Highway 2) and Whangarei.

The restricted travel times don't apply to a motor vehicle whose dimensions, although exceeding the maximum dimensions allowed for a standard vehicle, don't project outside the lane in which the vehicle is travelling, and the vehicle (including its load) has been certified (under Transport Agency approval) as meeting the road space requirements of a maximum size standard vehicle.

The restricted travel times also do not apply to vehicles designed to be operated in connection directly with the operation or management of a farm.

Please note that travel time restrictions do not apply to a motor vehicle that is being used in an emergency if the operator of the vehicle can provide evidence that the vehicle was required by:

- a road controlling authority to repair, or restore access to, a road, railway or bridge
- a territorial authority, or a public utility provider, to restore a public utility service
- the New Zealand Police to attend an incident or accident
- a territorial or local authority to stabilise land or otherwise reduce an imminent risk to persons or property
- the Controller, or any member of the New Zealand Police, or any person acting under their authority, to carry out emergency response work during a state of emergency declared under the Civil Defence Emergency Management Act 2002.

Category 2 requirements

These requirements are in addition to the general operating requirements.

Hazard warning panels

Hazard warning panels must be attached to indicate the:

- excess width on each side of an overwidth load or vehicle at its front and rear
- front of a load with excess front overhang
- rear of a load with excess rear overhang
- rear of a load for excess length.

The panels must:

- comply with AS/NZ 1906.1:2007 *Retro reflective materials and devices for road traffic control purposes, Part 1: Retro reflective materials*
- consist of retro-reflective material coloured yellow-green with either a 200mm- or 300mm-wide diagonal orange stripe
- have the illustrated dimensions and orientation
- be frangible (breakable or readily deformable) if any part of the hazard warning panel extends beyond the body of the vehicle or the load, whichever it is attached to.

You must not display hazard warning panels on a Category 2 vehicle unless you're required to by the Vehicle Dimensions and Mass Rule.

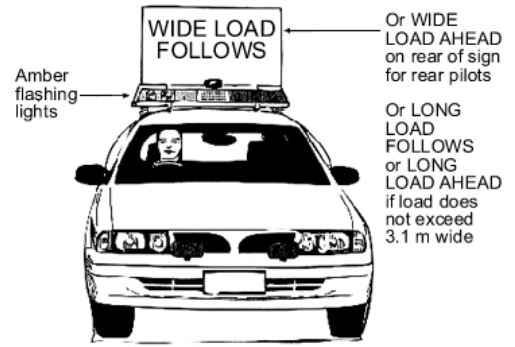
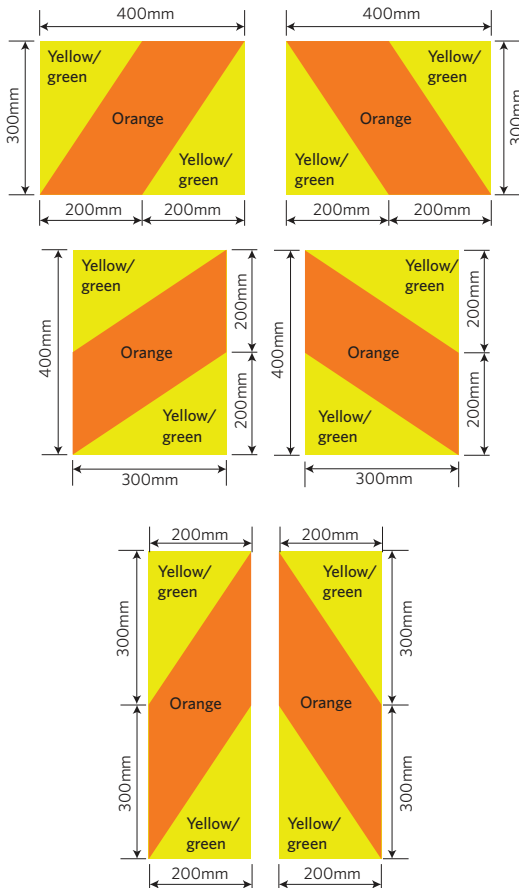

Restricted travel times

Category 2 overdimension vehicles must not travel:

- between 0700 hours and 0900 hours, or 1600 hours and 1800 hours, on Monday to Friday inclusive, in any city* area at times when there are unusually heavy traffic volumes
- between 1000 hours and 1300 hours, or 1600 hours and 1900 hours, on Saturday or Sunday
- between 23 December and 3 January inclusive
- on a national holiday, or after 1600 hours on the day preceding a national public holiday
- on a Saturday, if that day is 25 April
- in any province on its provincial anniversary holiday, or after 1600 hours on the day preceding that anniversary holiday
- at times when there are unusually heavy traffic volumes.

The restricted travel times are relaxed to those of Category 1 if the vehicle (including its load) has been verified (under Transport Agency approval) as meeting the road performance requirements equivalent to a Category 1 vehicle. A Category 1 vehicle that is designed to be operated in connection directly with the operation or management of a farm does not need to be verified, so long as it operates within its own lane.

The restricted travel times also do not apply to vehicles designed to be operated in connection directly with the operation or management of a farm.

Please note that travel time restrictions do not apply to a motor vehicle that is being used in an emergency if the operator of the vehicle can provide evidence that the vehicle was required by:

- a road controlling authority to repair, or restore access to, a road, railway or bridge
- a territorial authority, or a public utility provider, to restore a public utility service
- the New Zealand Police to attend an incident or accident a territorial or local authority to stabilise land or
- otherwise reduce an imminent risk to persons or property the Controller, or any member of the New Zealand Police, or any person acting under their authority, to carry out emergency response work during a state of emergency declared under the Civil Defence Emergency Management Act 2002.

* Note: City is defined as the urban areas of Auckland (between Albany and Drury), Christchurch, Dunedin, Hamilton, Hastings, Invercargill, Napier, Nelson, New Plymouth, Palmerston North, Tauranga, Wanganui, Wellington (including all areas south of McKays Crossing on State Highway 1 and Te Marua on State Highway 2) and Whangarei.

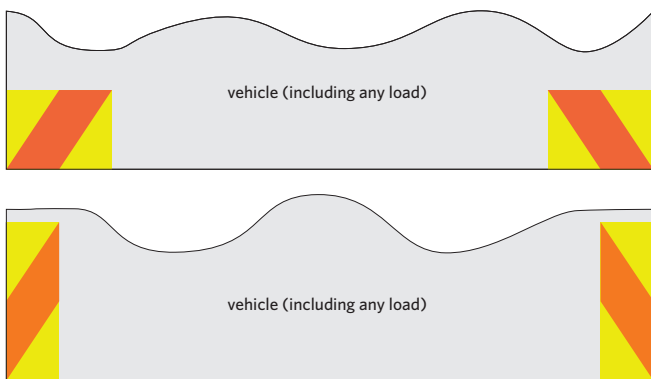

If the vehicle is more than 3.1 metres wide, Oversize signs must be displayed at the front and rear.



You must not display OVERSIZE signs unless required to do so by the Vehicle Dimensions and Mass Rule.

Piloting Category 2 vehicles or loads

Most Category 2 vehicles or loads must have at least one Class 2 pilot.

For a convoy of up to three agricultural motor vehicles that are travelling in company and all have dimensions within Category 2, it is sufficient to have one pilot vehicle at the front of the convoy and one pilot vehicle at the rear of the convoy.

Where you can find out more

- Factsheet 13 *Vehicle dimensions and mass: guide to the factsheet 13 series*
- Factsheet 13a *Heavy rigid vehicles*
- Factsheet 13b *Light rigid vehicles*
- Factsheet 13c *Heavy trailers and combination vehicles*
- Factsheet 13d *Trailers: Light simple trailers*
- Factsheet 13e *Static roll thresholds*
- Factsheet 13f *Heavy buses*
- Factsheet 13g *High Productivity motor vehicles*
- Factsheet 13h *Specialist vehicles.*
- Factsheet 53b *Overdimension roles and responsibilities*
- *Guide to safe loading and towing for light vehicles.*
- For more information, read Land Transport Rule: Vehicle Dimensions and Mass 2016
- Call the Overdimension Permit Issuing Agency (OPIA) Helpdesk: Phone 0800 OVERSIZE (0800 683 774) Fax 06 953 6313.

The information in this factsheet is a general guide only. It is not the source of the law and should not be used in place of authoritative legal documents. Some factsheets are updated frequently and print versions can quickly become out of date. If the currency of the information you are reading is important, check the factsheet index on our website (www.nzta.govt.nz/factsheets) or call us on 0800 699 000.

Contact details

- Call our contact centre: 0800 699 000.
- Visit our website: www.nzta.govt.nz.
- Email us: info@nzta.govt.nz.
- Write to us: NZ Transport Agency, Private Bag 11777, Palmerston North 4442.