

# Erosion and Sediment Control Guidelines for State Highway Infrastructure

## Construction Stormwater Management

© NZ Transport Agency

[www.nzta.govt.nz](http://www.nzta.govt.nz)

September 2014

ISBN 978-0-478-41973-3 (online)

## **Copyright information**

This publication is copyright © NZ Transport Agency. Material in it may be reproduced for personal or in-house use without formal permission or charge, provided suitable acknowledgement is made to this publication and the NZ Transport Agency as the source. Requests and enquiries about the reproduction of material in this publication for any other purpose should be made to:

Manager, Information  
NZ Transport Agency  
Private Bag 6995  
Wellington 6141

The permission to reproduce material in this publication does not extend to any material for which the copyright is identified as being held by a third party. Authorisation to reproduce material belonging to a third party must be obtained from the copyright holder(s) concerned.

## **Disclaimer**

The NZ Transport Agency has endeavoured to ensure material in this document is technically accurate and reflects legal requirements. However, the document does not override governing legislation. The NZ Transport Agency does not accept liability for any consequences arising from the use of this document. If the user of this document is unsure whether the material is correct, they should refer directly to the relevant legislation and contact the NZ Transport Agency.

## **More information ...**

NZ Transport Agency  
September 2014

ISBN 978-0-478-41973-3 (online)

If you have further queries, call our contact centre on 0800 699 000 or write to us:

NZ Transport Agency  
Private Bag 6995  
Wellington 6141

This document is available on the NZ Transport Agency's website at [www.nzta.govt.nz](http://www.nzta.govt.nz).

# Document management plan

## 1) Purpose

This management plan outlines the updating procedures and contact points for the document.

## 2) Document information

<b>Document name</b>	<i>Erosion and Sediment Control Guidelines for State Highway Infrastructure</i>
<b>Document number</b>	SP/M/023
<b>Document availability</b>	This document is located in electronic form on the NZ Transport Agency's website at <a href="http://www.nzta.govt.nz">www.nzta.govt.nz</a> .
<b>Document owner</b>	Craig Redmond, Senior Environmental Specialist
<b>Document sponsor</b>	Rob Hannaby, Environment and Urban Design Manager

## 3) Amendments and review strategy

All corrective action/improvement requests (CAIRs) suggesting changes will be acknowledged by the document owner.

	<b>Comments</b>	<b>Frequency</b>
Amendments (minor revisions)	Updates incorporated immediately they occur.	As required.
Review (major revisions)	Amendments fundamentally changing the content or structure of the document will be incorporated as soon as practicable. They may require coordinating with the review team timetable.	Three yearly
Notification	All users that have registered their interest by email to <a href="mailto:environment@nzta.govt.nz">environment@nzta.govt.nz</a> will be advised by email of amendments and updates.	Immediately.

## 4) Other information (at document owner's discretion)

There will be occasions, depending on the subject matter, when amendments will need to be worked through by the review team before the amendment is actioned. This may cause some variations to the above noted time frames.

## Record of amendment

Amendment number	Description of change	Effective date	Updated by

---

## Abbreviations

- ANZECC      Australia New Zealand Environmental and Conservation Council
- ARC          Auckland Regional Council
- BPO          Best Practicable Option
- ESCP        Erosion and Sediment Control Plan
- HAIL        Hazardous Activities and Industries List
- HIRDS      High Intensity Rainfall Design System
- NIWA        National Institute of Water and Atmospheric Research
- NZTA        NZ Transport Agency
- PAC         Poly Aluminium Chloride
- PAHs        Polycyclic Aromatic Hydrocarbons
- RECP        Rolled Erosion Control Products
- RMA         Resource Management Act 1991
- TSS         Total Suspended Solids
- U.S.         United States of America
- USLE        Universal Soil Loss Equation

## Acknowledgements

The Transport Agency would like to acknowledge both the Auckland Council and Environment Canterbury for their assistance in the development of this Guideline. Auckland Council has allowed photographs and technical figures to be used in the Guideline and Environment Canterbury has allowed the Glossary of their Erosion and Sediment Control Guidelines to be used as the basis for the Glossary in this Guideline. The Maryland State Highway Administration also provided photographs for use in the Guideline.

Their assistance is most appreciated.

## Contact Us

Environment and Urban Design Team  
Highway and Network Operations  
E: [environment@nzta.govt.nz](mailto:environment@nzta.govt.nz)

# Contents

<b>1. Introduction</b> .....	<b>1</b>
1.1 Background .....	1
1.1.1 Resource Management Act.....	2
1.1.2 National Policy Statement for Freshwater Management .....	3
1.2 Purpose .....	3
<b>2. Construction related issues</b> .....	<b>5</b>
2.1 Problem discussion.....	6
2.1.1 Climate .....	8
2.1.2 Soils .....	9
2.1.3 Slopes .....	10
2.1.4 Size of disturbance .....	12
2.1.5 Erosion and sediment control practices .....	12
2.1.6 Pathway and receiving system .....	13
2.2 Types of erosion that are associated with construction activities .....	13
2.2.1 Splash erosion.....	14
2.2.2 Sheet erosion .....	14
2.2.3 Rill erosion .....	15
2.2.4 Gully erosion .....	15
2.2.5 Tunnel erosion.....	15
2.2.6 Channel erosion.....	16
2.2.7 Mass movement.....	16
2.3 Wind erosion .....	17
2.3.1 Suspension.....	17
2.3.2 Creep.....	17
2.3.3 Saltation .....	17
2.4 Unique aspects of state highway construction .....	18
2.4.1 State highways are linear projects that may cross a number of catchments .....	18
2.4.2 Cuts and fills that may alter existing drainage patterns .....	18
2.4.3 They are limited in the amount of space that they occupy .....	18
2.4.4 There may be a need to maintain site traffic during construction .....	18
2.4.5 There may be numerous adjacent properties or land use activities .....	19

---

<b>3. Receiving environments</b> .....	<b>20</b>
3.1 Streams, rivers and wetlands.....	20
3.1.1 Streams and rivers.....	20
3.1.2 Wetlands .....	22
3.2 Ground.....	23
3.2.1 Adjacent properties.....	23
3.2.2 Karst geology.....	23
3.3 Estuaries .....	24
3.4 Harbours.....	26
3.5 Open coasts.....	27
3.6 Lakes.....	28
3.7 Overall discussion of erosion and sediment control related to receiving environments .....	29
<b>4. Erosion and sediment control concepts</b> .....	<b>30</b>
4.1 Advantages of erosion and sediment control.....	30
4.2 Concepts and principles of erosion and sediment control .....	30
4.2.1 Control upper catchment water.....	31
4.2.2 Separate clean from dirty.....	31
4.2.3 Reduce the area available for erosion .....	31
4.2.4 Minimise sediment from leaving the site.....	32
4.3 The role of erosion and sediment controls.....	32
4.3.1 Efficiency vs effectiveness of practices .....	32
4.4 The treatment train .....	33
4.5 Principles to follow.....	33
<b>5. Selecting a management approach</b> .....	<b>36</b>
5.1 Erosion control .....	36
5.2 Sediment control .....	37
5.3 Practice applicability and limitations.....	38
5.4 Development Lifecycle of an ESCP.....	40
5.4.1 Draft ESCP for Consenting .....	40
5.4.2 Construction ESCP.....	40
5.4.3 Individual method statements.....	41
<b>6. Hydrological design criteria</b> .....	<b>42</b>
6.1 Soils.....	42
6.2 Slopes .....	44

---

6.3 Rainfall .....	45
6.4 Ground cover .....	46
6.5 Risk .....	46
6.6 Criteria for risk reduction.....	48
6.7 Sizing for storage practices .....	48
6.7.1 Example calculations .....	49
<b>7. Project requirements.....</b>	<b>51</b>
7.1 Specific consenting requirements.....	51
7.1.1 Water quality discharge standards and BPO approach .....	52
7.1.2 Draft model resource consent conditions .....	54
7.1.3 Regional erosion and sediment control guidelines.....	54
7.1.3 Construction staging.....	54
7.1.4 Winter construction and shutdown period .....	56
7.3 NZTA minimum requirements.....	57
<b>8. Erosion control practices.....</b>	<b>58</b>
8.1 Check dams .....	59
8.1.1 Definition and purpose.....	59
8.1.2 Conditions where practice applies.....	59
8.1.3 Limitations .....	59
8.1.4 Key design criteria .....	60
8.1.5 Filter sock construction specifications .....	61
8.1.6 Maintenance.....	61
8.1.7 Decommissioning .....	62
8.2 Contour Drains (Cut-offs).....	63
8.2.1 Definition and purpose.....	63
8.2.2 Conditions where practice applies.....	63
8.2.3 Limitations .....	63
8.2.4 Key design criteria .....	64
8.2.5 Maintenance.....	65
8.2.6 Decommissioning .....	65
8.3 Diversion channels and bunds.....	66
8.3.1 Definition and purpose.....	66
8.3.2 Conditions where practice applies.....	66
8.3.3 Limitations .....	67



---

8.3.4 Key design criteria.....	67
8.3.5 Maintenance .....	70
8.3.6 Decommissioning.....	70
8.4 Pipe drop structure and flume.....	71
8.4.1 Definition and purpose .....	71
8.4.2 Conditions where practice applies .....	71
8.4.3 Limitations .....	71
8.4.4 Key design criteria.....	71
8.4.5 Maintenance .....	74
8.5 Stabilised Entranceway.....	75
8.5.1 Definition and purpose .....	75
8.5.2 Conditions where practice applies .....	75
8.5.3 Limitations .....	75
8.5.4 Key design criteria.....	75
8.5.5 Maintenance .....	77
8.5.6 Decommissioning.....	78
8.6 Surface Roughening .....	79
8.6.1 Definition and purpose .....	79
8.6.2 Conditions where practice applies .....	79
8.6.3 Limitations .....	79
8.6.4 Key design criteria.....	80
8.6.5 Maintenance .....	80
8.6.6 Decommissioning.....	80
8.7 Benched Slopes.....	81
8.7.1 Definition and purpose .....	81
8.7.2 Conditions where practice applies .....	81
8.7.3 Limitations .....	81
8.7.4 Key design criteria.....	81
8.7.5 Maintenance .....	83
8.7.6 Decommissioning.....	83
8.8 Topsoiling and grass seeding.....	84
8.8.1 Definition and purpose .....	84
8.8.2 Conditions where practice applies .....	84
8.8.3 Limitations .....	85
8.8.4 Key design criteria.....	85

---

8.8.5 Maintenance.....	87
8.8.6 Decommissioning.....	87
8.9 Hydroseeding.....	88
8.9.1 Definition and purpose.....	88
8.9.2 Conditions where practice applies.....	88
8.9.3 Limitations.....	88
8.9.4 Key design criteria.....	89
8.9.5 Maintenance.....	89
8.9.6 Decommissioning.....	89
8.10 Mulching.....	91
8.10.1 Definition and purpose.....	91
8.10.2 Conditions where practice applies.....	91
8.10.3 Limitations.....	92
8.10.4 Key design criteria.....	92
8.10.5 Maintenance.....	93
8.10.6 Decommissioning.....	93
8.11 Turfing.....	94
8.11.1 Definition and purpose.....	94
8.11.2 Conditions where practice applies.....	94
8.11.3 Limitations.....	94
8.11.4 Key design criteria.....	94
8.11.5 Maintenance.....	95
8.11.6 Decommissioning.....	95
8.12 Geotextiles, plastic covers, erosion control blankets and geo binders.....	96
8.12.1 Definition and purpose.....	96
8.12.2 Conditions where practice applies.....	96
8.12.3 Limitations.....	96
8.12.4 Key design criteria.....	97
8.12.5 Key installation considerations.....	102
8.12.6 Maintenance.....	103
8.12.7 Decommissioning.....	104
8.13 Dust Control.....	105
8.13.1 Definition and purpose.....	105
8.13.2 Conditions where practice applies.....	105
8.13.3 Limitations.....	105

---

813.4 Key design criteria.....	105
8.13.5 Maintenance .....	107
8.13.6 Decommissioning.....	107
<b>9. Sediment control practices .....</b>	<b>108</b>
9.1 Sediment retention pond .....	109
9.1.1 Definition and purpose .....	109
9.1.2 Conditions where practice applies .....	109
9.1.3 Limitations .....	110
9.1.4 Key design criteria.....	111
9.1.5 Construction specifications .....	121
9.1.6 Maintenance .....	122
9.1.7 Decommissioning.....	123
9.1.8 Safety .....	123
9.1.9 Chemical treatment.....	123
9.2 Silt fences .....	124
9.2.1 Definition and purpose .....	124
9.2.2 Conditions where practice applies .....	124
9.2.3 Limitations .....	124
9.2.4 Key design criteria.....	125
9.2.5 Construction .....	126
9.2.7 Decommissioning.....	128
9.3 Super silt fence.....	129
9.3.1 Definition and purpose .....	129
9.3.2 Conditions where practice applies .....	129
9.3.3 Limitations .....	129
9.3.4 Key design criteria.....	129
9.3.5 Construction .....	130
9.3.6 Maintenance .....	132
9.3.7 Decommissioning.....	132
9.4 Filter socks .....	133
9.4.1 Definition and purpose .....	133
9.4.2 Conditions where practice applies .....	133
9.4.3 Limitations .....	133
9.4.4 Key design criteria.....	133
9.4.5 Construction.....	135

---

9.4.6 Maintenance .....	135
9.4.7 Decommissioning .....	135
9.5 Decanting earth bund .....	136
9.5.1 Definition and purpose .....	136
9.5.2 Conditions Where Practice Applies .....	136
9.5.3 Limitations .....	136
9.5.4 Key design criteria .....	137
9.5.5 Construction .....	138
9.5.6 Maintenance .....	139
9.5.7 Decommissioning .....	139
9.6 Flocculation .....	140
9.6.1 Definition and purpose .....	140
9.6.2 Conditions where practice applies .....	140
9.6.3 Limitations .....	140
9.6.4 Key design criteria .....	141
9.6.5 Maintenance .....	145
9.6.6 Decommissioning .....	146
9.6.7 Alternatives to aluminium based flocculants .....	147
9.7 Dewatering .....	148
9.7.1 Definition and purpose .....	148
9.7.2 Conditions where practice applies .....	148
9.7.3 Limitations .....	148
9.7.4 Key design criteria .....	148
9.8 Stormwater inlet protection .....	150
9.8.1 Definition and purpose .....	150
9.8.2 Conditions where practice applies .....	150
9.8.3 Limitations .....	150
9.8.4 Key design criteria .....	151
9.8.5 Construction .....	151
9.8.6 Maintenance .....	152
9.8.7 Decommissioning .....	152
<b>10. Streamworks .....</b>	<b>154</b>
10.1 Temporary watercourse crossings .....	155
10.1.1 Definition and purpose .....	155
10.1.2 Conditions where practice applies .....	155

---

10.1.3 Design.....	155
10.1.4 Maintenance .....	159
10.2 Dam and pumping or dam and diverting .....	160
10.2.1 Definition and purpose.....	160
10.2.2 Design.....	160
10.3 Temporary waterway diversions.....	161
10.3.1 Definition and purpose.....	161
10.3.2 Conditions where practice applies .....	161
10.3.3 Design.....	162
10.3.4 Maintenance .....	163
10.4 Instream and near stream works.....	163
10.4.1 Design .....	163
10.4.2 Construction .....	164
10.4.3 Maintenance.....	164
<b>11. Variations and new product approach .....</b>	<b>165</b>
11.1 Proposed process of endorsement.....	165
11.2 New product acceptance.....	166
<b>References.....</b>	<b>167</b>
<b>Appendix A.....</b>	<b>172</b>
Glossary.....	172
<b>Appendix B – Soils of New Zealand.....</b>	<b>180</b>
North Island Soil Map as provided by Landcare Research .....	180
South Island Soil Map as provided by Landcare Research .....	181



# 1. Introduction

## 1.1 Background

The NZ Transport Agency (NZTA) holds a strong regard towards the natural, built and social environment. This is reflected in the external and internal strategy and policy documents, including the *NZTA Environmental and Social Responsibility Policy* and *State Highway Environmental Plan*. These documents and the *State Highway Environmental and Social Responsibility Standard* are consistent with the requirements of the Land Transport Management Act 2003 and the Resource Management Act 1991 (RMA) (refer to figure 1).

Erosion and sediment control is an important issue as sediment from state highway construction sites can have significant detrimental impacts on downstream receiving systems.

**Figure 1.1 NZTA Environmental and Social Statutory and Policy Context**

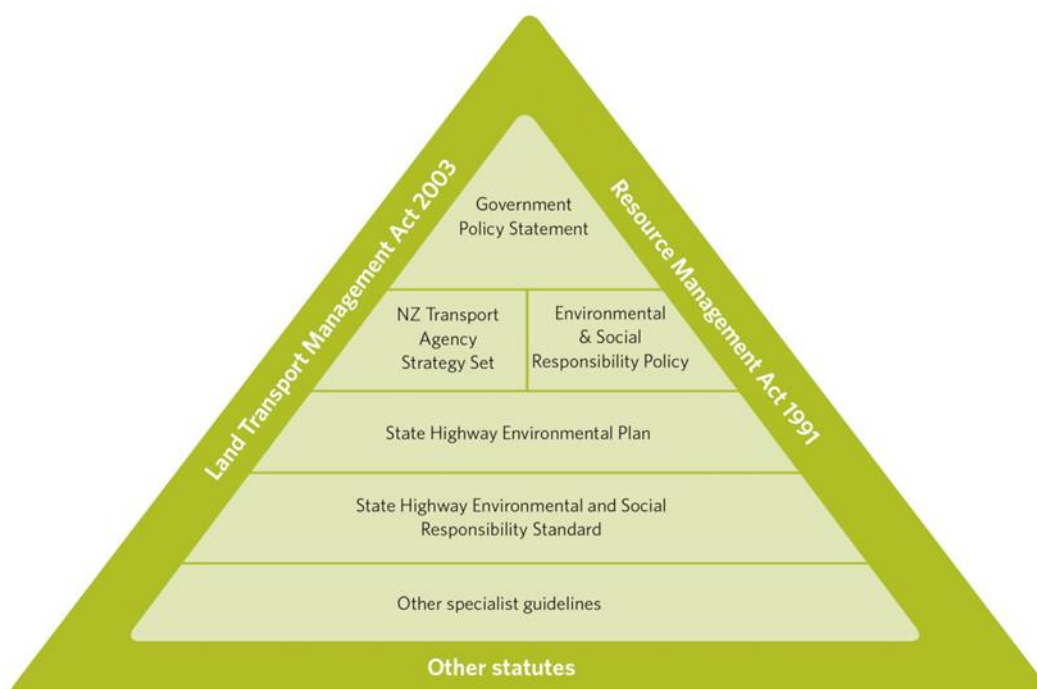

The State Highway Environmental Plan sets the formal objectives regarding erosion and sediment control for the state highway network;

- ES1 Ensure construction and maintenance activities avoid, remedy or mitigate effects of soil erosion, sediment run-off and sediment deposition.
- ES2 Identify areas susceptible to erosion and sediment deposition and implement erosion and sediment control measures appropriate to each situation with particular emphasis on high-risk areas.
- ES3 Use bio-engineering and low-impact design practices where practicable.

### 1.1.1 Resource Management Act

The primary legal mandate for implementation of erosion and sediment control in New Zealand is the RMA. The RMA establishes the framework of objectives, policies and rules within which the effects of construction related runoff is managed.

The 'sustainable management' purpose of the RMA requires those exercising functions, duties and powers under the RMA to manage the use, development and protection of natural and physical resources in a way, or at a rate, that enables people and communities to provide for their social, economic and cultural wellbeing and for their health and safety while, among other things, avoiding, remedying or mitigating any adverse effects of activities on the environment. Further, Section 17 of the RMA places a general duty on 'every person' to avoid, remedy or mitigate any adverse effects of activities on the environment, whether or not the activity or lawfully established use is in accordance with a national environmental standard, rule in a plan, a resource consent or a designation.

The State highway network is a 'natural and physical resource' in terms of the RMA and is required to be sustainably managed. The 'environment' is widely defined in the RMA to include all natural and physical resources; ecosystems and their constituent parts, people and communities, amenity values and the social, economic, aesthetic and cultural conditions that affect these matters.

Section 30 states the functions every regional council (including unitary authorities) will undertake for the purpose of giving effect to the RMA in its region. In regards to erosion and sediment control this includes;

- The establishment, implementation, and review of objectives, policies and methods to achieve integrated management of the natural and physical resources of the region.
- The control of the use of land for the purpose of;
  - Soil conservation,
  - The maintenance and enhancement of the quality of water in water bodies and coastal water, and
  - The maintenance and enhancement of ecosystems in waterbodies.
- In respect to any coastal marine area in the region, the control (in conjunction with the Minister of Conservation) of;
  - Land and associated natural and physical resources,
  - The taking, use, damming, and diversion of water,
  - Discharges of contaminants into or onto land, air, or water and discharges of water into water, and
  - Any actual or potential effects of the use, development, or protection of land.
- The control of discharges of contaminants into or onto land, air or water and discharges of water into water

Territorial authorities (which include city, district and unitary authorities) pursuant to Section 31 have a number of functions for the purpose of giving effect to the RMA in regards to erosion and sediment control, including:

- The establishment, implementation and review of objectives, policies and methods to achieve integrated management of the effects of the use, development or protection of land and associated natural and physical resources of the district.
- The control of any actual or potential effects of the use, development or protection of land.
- The control of any actual or potential effects of activities in relation to the surface of water in rivers and lakes.

As a general statement, regional authorities have responsibility for issues related to water quality and water quantity while territorial authorities have primary responsibility for issues related to subdivision and land use.



The means of implementation of environmental controls, primarily by regional authorities, is through regional plans that specify consenting requirements. These consenting requirements form the basis of erosion and sediment control planning, implementation and decommissioning. Specific council consenting requirements will be discussed in Section 7.

From a territorial authority context, the issue is less direct. State highways are often designated in district plans and do not require a specific resource consent under their plans for earthworks but may require a resource consent in relation to the National Environmental Standard for Assessing and Managing Contaminants in Soil to Protect Human Health.

### **1.1.2 National Policy Statement for Freshwater Management**

The National Policy Statement (NPS) for Freshwater Management 2011 came into effect on 1 July 2011, and decision-makers under the RMA must have regard to this. Local authorities are required to amend regional policy statements, proposed regional policy statements, plans, proposed plans, and variations to give effect to any provision in the National Policy Statement that affects those documents.

In relation to erosion and sediment control, the National Policy Statement water quality objectives and policies will need to be considered in any assessment of erosion and sediment control effects on the environment and by the decision-makers.

## **1.2 Purpose**

This guideline is intended to provide the minimum requirement for erosion and sediment control that state highway construction projects shall comply with. Construction includes new construction and state highway maintenance projects. This guideline has been prepared with the intention that it will meet or exceed current local erosion and sediment control guidelines so that compliance with it will minimise consenting related issues. If a local standard is amended and becomes more stringent than this Standard, the more stringent requirements shall be met if required by resource consent.

The guide focuses on the unique requirements of State Highway construction and takes into consideration the following site conditions when selecting an erosion sediment control practice;

- Climate,
- Soils,
- Slope,
- Size of disturbance,
- Receiving system that the project drains into,
- Cost,
- Effectiveness of the practice,
- Requirements of regulatory authorities, and
- Constraints of earthworking on linear projects.

With careful planning and design, adverse effects of sediment discharges resulting from construction and maintenance activities can be avoided or minimised. Moreover, the guideline will assist in attaining consistency nationwide by removing uncertainty with respect to the standard required for the design, construction and maintenance of erosion and sediment controls.

The guideline is comprised of the following sections;

- Construction related issues,
- Receiving environments,

- Erosion and sediment control concepts,
- Selecting a management approach,
- Hydrological design criteria,
- Project requirements,
- Erosion control practices,
- Sediment control practices,
- Streamworks and
- New product consideration.

## 2. Construction related issues

Problems associated with construction site runoff have been known for many years. There is even a book (Carter, Dale, 1974) that discusses the rise and fall of civilisations in part due to declines in soil fertility due to soil erosion. The book discusses most areas of the world and looks at the civilisations that thrived, then declined and their lack of resources today.

Other studies have been done on tributaries to the Chesapeake Bay in the United States of America (U.S.) and the impact that construction related runoff was having on downstream sedimentation (Fox, 1974). In the early 1980's the Auckland Council (AC) studied the Upper Waitemata Harbour to consider the sources of sediment that were infilling the upper harbour.

One of the greatest impacts of urbanisation on receiving waters can come from soils eroded during urban construction (Williamson, 1993). The degree of the erosion depends on the amount and intensity of rain that falls while the soil is exposed in addition to the other factors explained previously.

This erosion can have an enormous impact immediately downstream of new earthworks. Dumped sediment can greatly alter the stream channel morphology, smother insect life and water draining these catchments can remain very turbid even during low flows. Table 2-1 provides mean values of turbidity and suspended solids in New Zealand streams during low flow.

**Table 2-1 Mean values of turbidity and suspended solids in New Zealand urban streams during low flow**

Land use	Turbidity (NTU)	Suspended Solids (g/m <sup>3</sup> )	Approximate visual range (m)
Residential	9	14	1
Residential, light industrial, construction	42	53	0.2
Construction	186	159	0.1

The information contained in Table 2.1 is based on suspended solids and turbidity. Suspended solids are a common water quality measurement that provides the weight of particulate material in a given sample while turbidity is a measure of water clarity. There is not a consistent relationship between the two and samples would normally have to be taken at an individual site to develop the relationship for them. Once that relationship is established, turbidity can then be easily taken and provide a representation of total suspended solids.

Measurements of suspended sediment yields during storms in five small basins under various landuses in the Auckland region were analysed to determine the average yields of sediment from those catchments (Hicks, 1994). The average sediment yields are shown in Table 2-2.

**Table 2-2 Average sediment yields for five small catchments**

Catchment identification	Sediment yield (t/km <sup>2</sup> /year)
Alexandra (urbanising)	970 (1.2 years of record)
Wairau (mature urban)	107 (6 years of record)
Pakuranga (mature urban)	24 (4.5 years of record)
Manukau (pasture)	49 (17 years of record)
Whangapouri (market-gardening)	49 (3 years of record)

The high yield from the urbanising Alexandra Basin stems from the considerable portion of its ground area that was bare for construction (approximately 28% at the time of the study). The

yield from the sub-catchments undergoing construction was estimated to be approximately 6,600 t/km<sup>2</sup>/year, over 100 times the yield from undisturbed or stable areas of the basin.

Another study by NIWA (Senior, 2003) provided estimates for bare soil sediment runoff of 14,400 kg/ha/year, a 32 times increase from pastoral land. The magnitude of predicted increase lies within the range (10-100 times) historically reported for sediment yields from construction sites.

Recent monitoring of sediment pond performance through two studies (Moore and Pattinson, 2008; Larcombe, 2009) provides some further information regarding total suspended solids (TSS) concentration. The median TSS concentration for the Moore's study on an NZTA project was 1,057g/m<sup>3</sup> for inflow to a sediment pond. The Larcombe study was on a general subdivision development and showed a much higher TSS load for average suspended sediments concentration of 11,542 g/m<sup>3</sup>, which is very high and demonstrates the variability of concentrations due to site variability.

In a study done for the AC, NIWA (Lohrer et.al, 2004) studied terrestrially derived sediment and the impact that has on marine macrobenthic communities related to thin terrigenous deposits. Coastal marine habitats adjacent to catchments with encroaching human development are likely to experience increased sediment loadings in ensuing decades. Thus, sedimentary disturbance regimes in which coastal marine benthic communities have evolved may be shifting as depositional events exceeding critical thresholds become more frequent. Performing manipulative experiments involving layers of terrigenous sediment < 1 cm thick in a variety of intertidal habitats in the Whitford embayment, North Island results of three separate experiments performed at five sites, as little as 3mm of the terrigenous material was sufficient to significantly alter macrobenthic community structure. The direction of change was predominantly negative. The number of individuals and taxa declined as a result of sediment application, as did the densities of nearly every common species. In addition, repeated depositional events did more damage than single ones.

Another study done (Gibbs, Hewitt, 2004) provides the following information on impacts to estuarine systems.

- Thin depositions (3-7mm) in Mahurangi and Kawau Bay on macro fauna, nitrogen and oxygen fluxes in the sub tidal zone caused significant adverse effects on macro fauna.
- Catastrophic depositions (>3cm) in Okura and Whangapoua on macro fauna in the intertidal zone. Within ten days nearly all the macro fauna had died.
- Thinner depositions (1.5-2cm) in Whitianga on macro fauna at the intertidal zone. Sediment deposition had an immediate effect with slow recovery (210 days).

In addition to the biological and ecological effects from accelerated erosion, sediment-laden discharges are considered unappealing from an aesthetics perspective. Clean water is something that people consider to be of value as part of the 'Clean & Green' image of New Zealand.

## 2.1 Problem discussion

In considering erosion and sediment control, there are two terms that can be considered:

- Erosion, and
- Sediment control.

There is a direct relationship between the two.

Simplistically, erosion is detachment: detachment of soil particles from the ground's surface. The detached particles become sediment once entrained by water.

Erosion is a natural process and even land covered by native vegetation has erosion. Earthworking activities, however, dramatically increase erosion rates. Natural erosion is generally considered in geological terms (hundreds of years), whilst accelerated erosion from our activities is considered frequently from an annual basis.

When a raindrop strikes a surface, pressure acts to destabilise the particles. The loadings due to impact are not uniform and are concentrated at the edge of the contact area. When the drop strikes a surface, lateral jet streams impinge on adjacent irregular surfaces or dirt particles, further destabilising the surrounding area. Based on typical drop sizes of about 1.5mm, and a terminal velocity of approximately 5.5m/sec, it can be calculated that each drop contains about  $3 \times 10^{-4}$  joules of kinetic energy (Springer, 1976). A 3mm per hour rain delivers about 11 joules/m<sup>2</sup>/minute, while a 12mm/hour rain delivers about 30joules/m<sup>2</sup>/minute. Rainfall intensity is a key element in determining the kinetic energy needing to be dispersed (Pitt, Clark, Lake 2007).

**Impact of a raindrop Hitting the Ground**

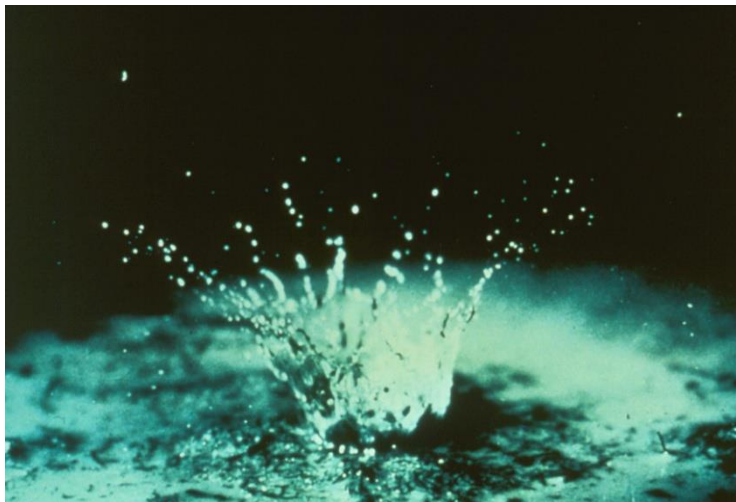

Raindrop impact initiates soil erosion, and preventing that erosion is a key element in an overall erosion and sediment control strategy. The primary means of limiting this erosion is to provide either permanent or temporary vegetative cover to dissipate the raindrop impact and reduce soil erosion potential. Erosion control is the key first step in reducing site erosion and reducing the amount of work that sediment control practices have to do. Erosion control is also an important element in reducing potential erosion due to high winds.

One aspect of erosion that is not being addressed in this guideline is the issue of mass movement erosion. This issue is considered as a geotechnical issue and will be considered in individual project design.

Sediment control, on the other hand, provides a process for deposition. Deposition is where the sediments being transported by water are prevented from leaving the site where they were generated through the implementation of practices that, in general, promote sedimentation. A basic premise of most sediment control practices is that they hold water in them until the weight of the sediments conveys the sediments, through gravity, to the bottom of the practice, where they settle.

If sediment is not captured on-site by sediment control practices, sediment loadings to receiving systems are increased. There may be economic impacts associated with the increased deposition of sediments downstream. The sediments can clog culverts and fill in drainage channels, storm drain systems, harbours and marina areas. Significant public expenditure is done maintaining these areas. In addition to economic impacts, there are environmental impacts related to reduction in light penetration due to elevated turbidity and smothering of bottom dwelling aquatic organisms by sediment deposition.

As mentioned in the Introduction, there are a number of site conditions that dictate what practices can be used. A common way of considering potential sediment yield is to consider the Universal Soil Loss Equation (USLE). The USLE is an empirical formula that was developed approximately thirty years ago (Wischmeir, Smith, 1978) and is represented by the following equation.

$$A = R \times K \times (LS) \times C \times P$$

Where:

- A = soil loss (tonnes/hectare/year)
- R = rainfall erosion index (J/hectare)
- K = soil erodibility factor (tonnes/unit of R)
- LS = slope length and steepness factor (dimensionless)
- C = vegetation cover factor (dimensionless)
- P = erosion control practice factor (dimensionless)

As can be seen, the factors mentioned in the Introduction are key factors in consideration of the erosion process. This guideline identifies state highway erosion and sediment control practices that account for the following:

- Climate,
- Soils,
- Slope,
- Size of disturbance,
- Erosion and sediment control practices,
- Pathway and receiving system that the project drains into,
- Practice effectiveness,
- Regulatory authority requirements,
- Cost, and
- State highway construction constraints.

### 2.1.1 Climate

Climate has an impact on the approach that is taken for erosion and sediment control. Climate consists of the following items:

- Precipitation intensity, duration and frequency, and
- Temperature.

Precipitation can be either snow or rainfall but from the context of sediment discharge, rainfall is far more of a concern. Erosion potential is directly related to the intensity of a given storm. Greater rainfall intensities relate to greater erosion potential. A low intensity rainfall results in reduced erosion potential. The greatest rainfall intensity that would be considered is 76 mm/hour as median raindrop size does not increase past this when intensities exceed 76 mm/hour. This peak value is only considering raindrop erosion. Site erosion is also caused by overland flow causing rill, gully and channel erosion, but the point here is that rainfall itself initiates the erosion process.

A common measure of rain erosivity is provided in the USLE (Wischmeier, Smith, 1978). In that equation rain erosivity is a factor that is a product of a total kinetic energy of the storm and the maximum rainfall (variable depending on purpose). The rainfall erosion index is the product of rainfall energy and the rainfall intensity. Rainfall energy is dependent on rain intensities.

A good example of rainfall droplet sizes and velocities for various types of rainfall is shown in Table 2-3 (Goldman, Jackson, Bursztynsky, 1986).

**Table 2-3 Rainfall droplet sizes and velocities for various types of rainfall**

Rainfall	Median diameter (mm)	Velocity of fall (m/s)
Fog	0.01	0.003
Mist	0.1	0.21
Drizzle	0.96	4.1
Light rain	1.24	4.78
Moderate rain	1.6	5.7
Heavy rain	2.05	6.7
Excessive rain	2.4	7.31
Cloudburst	2.85	7.89

## 2.1.2 Soils

Soil texture and other soil characteristics affect the soil's potential for erosion. Many characteristics of soils, including texture, acidity, moisture retention, drainage and slope have an influence on the soils' vulnerability to erosion. The following soil characteristics have primary importance in determining soil erodibility:

- Texture
- Organic matter content,
- Structure, and
- Porosity.

Soil maps for New Zealand, as supplied by Landcare Research, are shown in Appendix B. The maps clearly detail the diversity of soils that exist throughout the country.

**Table 2-4 Soil characteristics**

<b>Soil texture</b>
Soil texture relates to the sizes and proportions of the particles making up a soil. Sand, silt and clay are the three major classes of soil particles. Sand has a coarse texture while silts and clays are fine textured. Soil texture relates to erodibility as sands have a higher infiltration potential and reduce the volume of water being discharged and thus have less erosion. Clays are bound tightly together and resist erosion but once erosion starts it is difficult to trap these finer soils.
<b>Organic matter content</b>
Organic matter is primarily plant and animal litter in various stages of decomposition. Organic matter improves soil structure and increases permeability, water retention capacity and soil fertility. Organic matter, which is primarily found in topsoil, reduces runoff and erosion potential.
<b>Structure</b>
Soil structure includes the arrangement of particles into aggregates (groups of particles) and the size, shape and distribution of pores both within and between the aggregate.

There are a number of factors that influence soil structure (Rowell, 1994). These factors include the following:

- Physical processes,
  - Drying and wetting which cause shrinkage and swelling with the development of cracks and channels,
  - Freezing and thawing which create spaces as ice is formed.
- Biological processes.
  - The action of plant roots, which remove water resulting in the formation of spaces by shrinkage, release organic materials, and leave behind organic residues and root channels when they die.
  - The action of soil animals which move material, create burrows and bring mineral and organic residues into close association.
  - The action of micro-organisms which break down plant and animal residues, leaving humus as an important material which binds particles together.

The formation of soil structure thus requires both physical rearrangement of particles and the stabilisation of the new arrangement. Stability is particularly associated with organic materials linking mineral particles together and with clay minerals and sesquioxides (an oxide containing three atoms of oxygen with two atoms of another element).

### Porosity

Soil porosity is of vital importance in the ability of soils to support plant, animal and microbial life. The spaces hold water, allow for drainage, allow entry of oxygen and removal of CO<sub>2</sub> from the soil, allow for root penetration into the soil and are indirectly responsible for modifying the mechanical properties of soils.

Soil porosity depends on the structure of the soil. It varies depending on:

- Texture and organic matter content,
- Depth in the soil profile,
- Management, as this causes changes in organic matter content over time and applies forces to soils which may either loosen or compact them.

Organic matter and the associated biological activity in soils are of major importance in maintaining soil porosity.

### 2.1.3 Slopes

The erosion of soil from a slope increases as the slope increases and lengthens (Senior, et.al, 2003). Table 2-5 shows a clear relationship between slope and sediment loading. An important conclusion of the study is that the erosion rate triples as slope doubles. This makes the clear statement that steeper slopes contribute a disproportionate level of sediment for the same disturbed area.



**Table 2-5 The effect of slope on sediment erosion rate in the Mangemangeroa Catchment**

Slope class (ave. degree)	100% earthworks (tonnes/km <sup>2</sup> /year)			Pasture (tonnes/km <sup>2</sup> /year)	Increase fold over pasture median
	low	median	high		
B (5.5°)	57,300	122,000	264,000	660	185
C (11.5°)	183,000	363,000	718,000	3,300	110
D (18°)	311,000	641,000	> 1,000,000	8,100	80
E (23°)	422,000	816,000	> 1,000,000	13,000	63

In addition, other work has been done which also demonstrates the linkage between slope and sediment yield. Figure 2-1 illustrates that linkage (Barfield, 1986). In addition to showing sediment yield increases for increasing slopes, the figure also shows the effects that vegetation has on sediment yield. Notice that the scale of the figure is logarithmic.

Slope length and steepness are critical factors in erosion potential, since they determine to a large extent the velocity of surface runoff. The energy and erosion potential of flowing water increases as the square of the velocity.

Figure 2-1  
Relationship between slope/vegetative cover and Sediment Yield

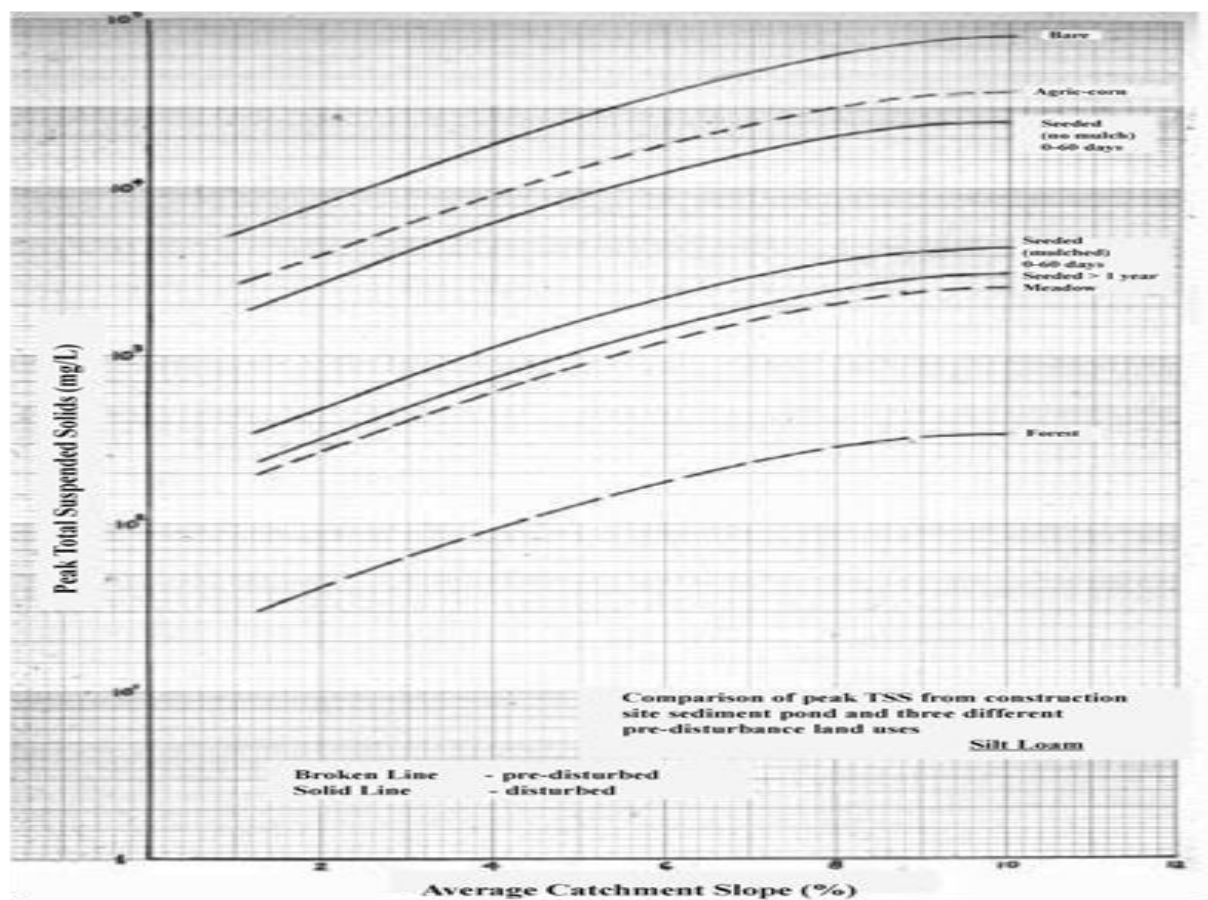

## 2.1.4 Size of disturbance

The size of disturbance also impacts on sediment yield. Greater areas of site disturbance increase erosion potential. Removal of vegetative cover, including vegetation and topsoil, increases surface runoff and erosion potential. Vegetation enhances evapotranspiration, which tends to dry soils out between storm events. Vegetation also has a roughness associated with it which tends to accelerate or retard the flow of water across it. Table 2-3 (ARC, 2000) shows the increased time that water takes to travel across various surfaces. Longer travel times reduce the potential for erosion of land surfaces.

**Table 2-5 Roughness coefficients for various surface covers and travel times**

Surface	Roughness Coefficient (unitless)	Travel Time (hours) <sup>1</sup>
Bare soil	0.011	0.014
Pasture	0.13	0.093
Grass (short)	0.15	0.109
Grass (taller)	0.24	0.159
Bush (light understory)	0.40	0.24
Bush (dense understory)	0.80	0.447

<sup>1</sup> Assumed 50m length, 12% slope, and 83 mm of rainfall

At low levels of site disturbance (4-10% of total site area), median sediment loadings are predicted to increase approximately 4 fold over existing land use sediment loadings. However, for maximum disturbance by earthworks (100%) the predicted increases in median loads range from about 40 to over 80 fold (NIWA, 1997).

## 2.1.5 Erosion and sediment control practices

The previous items in Sections 2.1.1 – 2.1.4 relate primarily to erosion. This item accepts that there is erosion, and erosion control and sediment control practices which are implemented to reduce downstream sediment loadings. Implementation of erosion control practices reduce particle dislodgement while implementation of sediment control practices capture sediments in transport and prevent those sediments from migrating downstream. Examples of erosion control and sediment control are shown in the images below.

Straw mulch being blown onto a state highway project to reduce erosion



Sediment retention pond to capture state highway sediments



Most effort should be put into preventing sediment generation in the first instance by the implementation of erosion control.

The effectiveness of erosion and sediment control practices will be discussed in later sections.

### 2.1.6 Pathway and receiving system

The proximity of the earthworked area to a receiving system is important when considering the possible impact that site works can cause. The sensitivity of the receiving environment is a critical factor in determining the level of control that needs to be implemented.

As discussed in section 3, a receiving environment can include the following:

- Ground,
- Streams, rivers and wetlands,
- Estuaries,
- Harbours,
- Open coasts, and
- Lakes

In addition to the receiving system, the pathway that the sediment laden runoff takes to get from the site being earthworked to the receiving system is also important. Having enclosed storm drains on site would allow for almost 100% delivery to the receiving environment. In a similar fashion, having the receiving system near to the earthworking activity means that there is little buffering between the earthworks and the receiving system. The significance of the pathway relies on its ability to provide some additional polishing of the sediment laden runoff prior to its entry into a receiving system. Some pathways provide a level of buffering while others do not.

In general, a pathway must have sheet flow to allow for the pathway itself to provide for additional sediment capture. If there is concentrated flow, the pathway is ineffective at further sediment reduction and should not be accounted for.

## 2.2 Types of erosion that are associated with construction activities

There are seven main types of erosion associated with earthwork activities (ARC, 1999) as shown in Figure 2-2.

- Splash,
- Sheet,
- Rill,
- Gully,
- Tunnel,
- Channel, and
- Mass movement.

State highway construction showing earthwork area and limited pathways prior to entry into streams



Figure 2-2 Types of Erosion

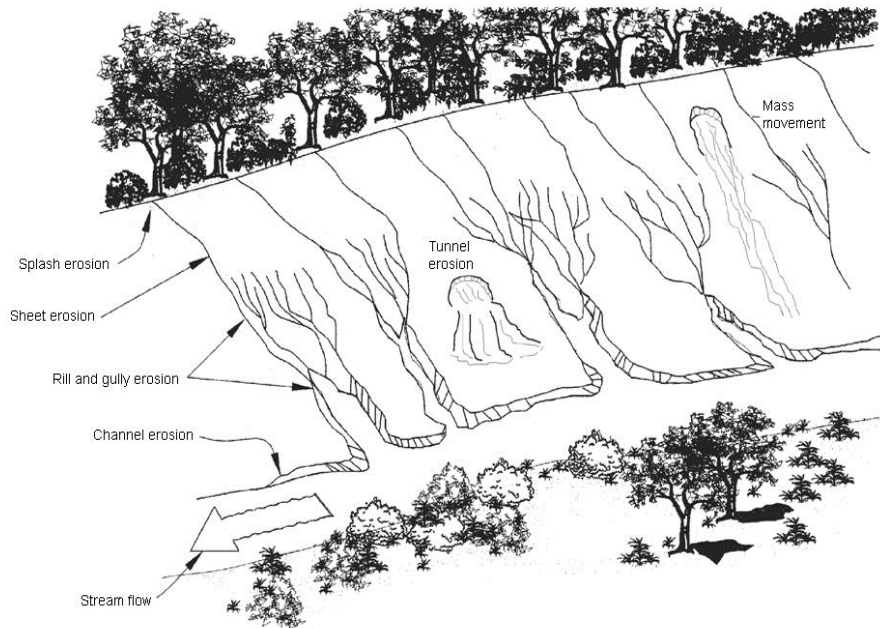

### 2.2.1 Splash erosion

When ground vegetation is removed from an area being earthworked, the soil surface is exposed to raindrop impact. On some soils, a very heavy rainfall may splash as much as 224 tonnes/ha of soil. Some of the splashed particles may rise as high as 0.6 m above the ground and move up to 1.5 m horizontally (Goldman, Jackson, Bursztynsky, 1986).

When raindrops hit bare ground, the soil aggregates are broken up and soil structure is destroyed.

Schematic of Raindrop Splash



### 2.2.2 Sheet erosion

When rainfall intensity exceeds the soils ability to absorb the rainfall, overland flow is initiated. Initial runoff tends to be in the form of sheet flow, where the runoff is in a shallow dispersed flow where there is no concentration of flow. It can be a significant erosion process as it can cover large areas.

The shallow flow rarely moves more than a few metres before the onset of flow concentration due to surface irregularities.

Sheet Erosion across the Ground Surface



### 2.2.3 Rill erosion

Rill erosion is the transition area where sheet flow becomes concentrated flow. At this point, the velocity of flow increases and is accompanied by increased turbulence. The energy of water is increased as the flow depth increases and this provides greater ability to detach and convey soil particles. Rills are small but well-defined channels that may be only a 10-20 mm deep.



**Rill Erosion**

### 2.2.4 Gully erosion

Gully erosion is a complex process that is not fully understood. Some gullies are formed when runoff cuts rills deeper and wider or when the flows from several rills come together and form a larger channel. Gullies can erode in both uphill and downhill directions (Goldman, Jackson, Bursztynsky, 1986).

The following are the processes which act in the formation of gullies (ARC, 1999):

- Waterfall erosion at the head of a gully,
- Channel erosion,
- Raindrop splash,
- Diffuse flow from the side of the gully or from seepage, and
- Slides or mass movement of soil within the gully.



**Gully Erosion**

A gully may develop and grow rapidly and their formation may generate a considerable amount of erosion.

### 2.2.5 Tunnel erosion

Compacted bare areas generate runoff which flows directly into the subsoil via surface cracks, rabbit burrows, or old root holes. Once concentrated in the subsoil the runoff causes the sodic clays (having high concentrations of sodium) to disperse and form a suspension or slurry. Provided there is sufficient gradient, the slurry is able to flow beneath the soil surface. If the subsoil is exposed through erosion or construction work, the slurry is able to rapidly flow onto the surface. Once formed, tunnels continue to enlarge during subsequent wet periods. Eventually tunnels reach a point where the roof collapses resulting in potholes and the



**Tunnel erosion**

formation of erosion gullies. Another way for tunnel erosion to occur is in limestone areas where water dissolves the limestone and creates underground flow paths.

- Tunnel erosion appears as a series of tunnels that form beneath the soil surface
- It is both a chemical and physical erosion process
- Associated with changes in catchment hydrology or uneven saturation of clay subsoils
- Usually associated with sodic soils derived from Triassic sandstone, Permian mudstones and re-deposition of these sediments in Quaternary deposits.

Tunnel erosion may form a circular hole, sometimes referred to as a 'tomo', which is a Maori term for an entrance to a sinkhole or cave. Tunnels may range in size from a few centimetres to several metres in diameter.

### 2.2.6 Channel erosion

The erosion of channels results from the conveyance of concentrated flows, whose velocities scour the channel boundaries. Channel erosion is a natural occurrence but accelerated erosion is caused by a change in land use that increases the volume and rate of stormwater runoff.

Channel erosion is a major source of sediment nationwide and is increased through changing land use.

**Channel erosion**



### 2.2.7 Mass movement

Mass movement is the erosion of soil or rock by gravity-induced collapse. It is usually triggered by groundwater pressure after heavy rain, but can also have other causes, such as stream bank undercutting or earthworks undercutting the base of a slope. Movement can be either rapid or near instantaneous or slow and intermittent. Earth and soil slip movement are also often noted after the removal of vegetation from critical slopes associated with earthworks (ARC, 1999).

Mass movement can cause major problems on earthworks sites and geotechnical investigations should be undertaken where possible to avoid critical slopes from failure.

**Mass movement**



## 2.3 Wind erosion

Most areas of New Zealand are subject to wind erosion. Wind erosion can occur during earthworks when areas have been cleared of vegetation and soil moisture deficits allow for transport.

The air quality assessment to support the project Assessment of Environmental Effects may have assessed the construction air quality impacts, which includes dust (wind erosion) (NZTA, 2012). The methods to avoid, remedy or mitigate the effects of dust are linked to the erosion and sediment control practices outlined in this guideline. If construction air quality is a concern for the project, the erosion and sediment control plan may be adequate to address the issue if it relates to wind erosion.

There are three ways that soil moves due to wind as shown in Figure 2-3 (Hawke's Bay Regional Council, 2002).

- Suspension,
- Creep, or
- Saltation.

**Figure 2-3**  
**Schematic of Types of Wind Erosion**

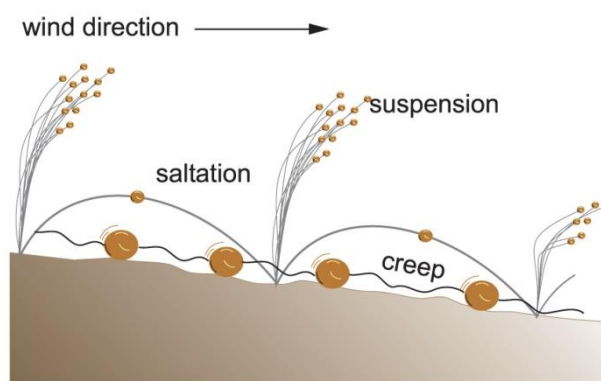

### 2.3.1 Suspension

The smallest particles are picked up and suspended in the wind, causing visible dust clouds that can travel great distances. While the amount of soil moving in wind currents is fairly small, it is lost soil material that can coat objects downwind from the area they are being generated.

### 2.3.2 Creep

The largest, heaviest particles remain stable or creep along the soil surface. Generally they do not travel very far.

### 2.3.3 Saltation

Medium sized particles account for 50-80% of soil movement through a process known as saltation. Wind causes medium sized particles to vibrate, and then bounce from the soil surface. They are too big to remain suspended and tend to fall and dislodge other particles that repeat the process in a snowballing effect. This can create soil avalanches, which are thick soil clouds up to two metres deep moving down wind.

Erosion control, primarily through ground cover is a key step in reducing wind erosion effects. Rapid site re-stabilisation can hold soil together, reduces wind velocity at the ground surface and traps any moving particles.

## **2.4 Unique aspects of state highway construction**

Erosion and sediment control for state highway construction is not always as straight forward as for general construction. There are a number of aspects of state highway construction that can be considered as unique. These aspects include the following:

- State highways are linear projects that may cross a number of catchments,
- They may require significant cuts and fills that may alter existing drainage patterns,
- They are limited in the amount of space that they occupy,
- There may be a need to maintain site traffic during construction, and
- There may be numerous adjacent properties or land use activities.

State highway construction is significantly more complicated from an erosion and sediment control perspective compared to general construction projects.

### **2.4.1 State highways are linear projects that may cross a number of catchments**

Most conventional construction is in one catchment with the entire site draining to a point where sediment control practices may be placed conveniently. State highway projects do not always have that ability to place one practice at the lowest point. The linear nature of a state highway may mean that there are a number of low areas where management has to be provided. This makes designing erosion and sediment control practices more complicated and there is a greater potential for a problem to compromise outcomes.

### **2.4.2 Cuts and fills that may alter existing drainage patterns**

A state highway project that must traverse hilly country has issues related to alignment and grade that must be met for safety reasons. This may necessitate significant cuts and fills to meet those requirements. Grade changes may be necessary during project construction that requires phasing of practices as certain elevations are attained. Catchment areas to practices may increase, decrease or be eliminated. This results in a much more careful approach to site management than may be required on a general construction site.

### **2.4.3 They are limited in the amount of space that they occupy**

In urban or urbanising areas obtaining the necessary land for the state highway works may be difficult and costly. This means that the amount of land that is necessary for the new state highway or for lane additions is generally kept to a minimum to minimise costs. Sediment control practices occupy space and their implementation may be difficult in a given situation.

Where possible, consideration of erosion and sediment control practices should occur prior to obtaining the designation for a particular project to seek to ensure that adequate land is available for the effective function of erosion and sediment control practices.

### **2.4.4 There may be a need to maintain site traffic during construction**

This concern is in conjunction with the previous one related to space limitations. If lane additions are being done, it is necessary to maintain traffic during construction, which further reduces the area available for erosion and sediment control practices. There may be situations where creative thinking is needed to minimise impacts to receiving environments due to space limitations. It is essential that traffic safety be provided so careful consideration has to be given to the use of the site area for the various work elements.



#### **2.4.5 There may be numerous adjacent properties or land use activities**

Being surrounded by various properties and land uses will present a challenge to implementation of effective erosion and sediment control. Drainage from adjacent properties may enter the state highway site and that water must be considered in the design of erosion and sediment control.

In addition to drainage issues, there may be issues related to construction noise, air pollution or relationship issues with various property owners. There may also be access issues during construction, which could impact on adjacent businesses.

These issues are not normally as critical during general construction as they are on state highway construction.

## 3. Receiving environments

Having an awareness of where water goes and the sensitivity of receiving environments will determine, to a large extent, requirements for erosion and sediment control for State Highway construction. For the most part, people do not think of where sediment goes once it leaves a site other than it “goes away”. It is important to recognise that receiving environments have value, are threatened and require a greater level of protection, which should improve awareness and action.

Receiving environments from an erosion and sediment control perspective include the following:

- Streams, rivers and wetlands,
- Ground,
- Estuaries,
- Harbours,
- Open coasts, and
- Lakes

Each of these environments will be discussed individually to provide context for their value.

One aspect that is common to all receiving environments is the potential for human interaction for recreational purposes. This issue can be important in terms of receiving environment impact but will not be discussed further in the individual subsections.

### 3.1 Streams, rivers and wetlands

#### 3.1.1 Streams and rivers

Streams and rivers provide a means of conveyance of stormwater runoff from the tops of catchments to lakes, estuaries, harbours and open coast areas. While there is no cut off point for when a stream becomes a river, normal nomenclature considers a river as a large stream. In the context of this section, streams and rivers are considered similarly. Similarly the term ‘creek’ is considered identical to stream and thus the term stream includes creeks, tributaries or brooks.

Streams in upper catchments tend to be in the form of a series of riffles and pools as shown in Figure 3-1. The riffles and pools, in conjunction with woody vegetation form the primary habitat for aquatic life. Streams in the lower portion of catchments tend to be muddy bottomed or gravel bottomed (Canterbury plains as an example) due to flatter slopes.

Another key element of a stream is slope. Figure 3-2 shows a typical stream profile

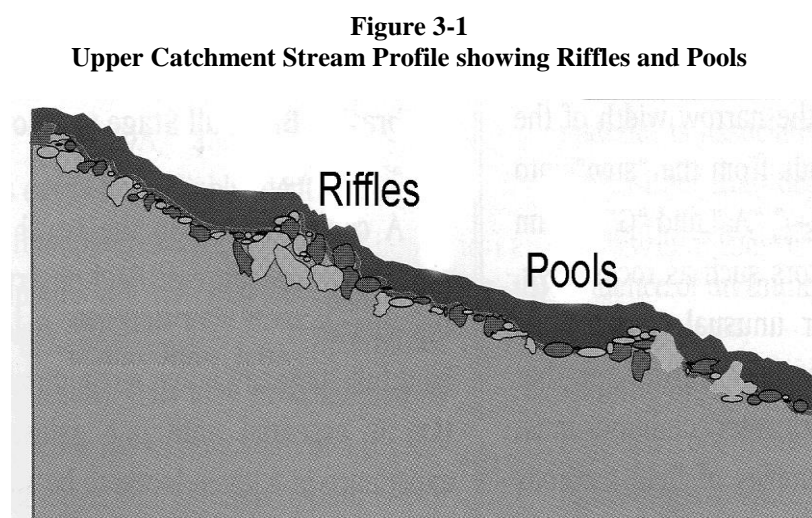

where the slope in the upper portion of the stream is very steep and the stream slope reduces as the stream approaches tidal areas. In this schematic the stream is the Vaughan's Stream (NSCC, 1999) and the difference in slope from headwater to coast is clearly evident.

From a descriptive standpoint, rivers tend to be in areas of shallower slope. One definition of a river is where the banks are 18 metres apart (Wikipedia Free Encyclopaedia).

The two figures, when considered in conjunction with one another demonstrate two important points related to sediment related issues. Excess sediment loads can fill in a stream pool and make the stream bottom homogeneous with little habitat. In addition, stream and river flow carrying capacity is reduced as the stream cross-sectional area reduces due to deposition in the stream bottom. The portion of a stream or river in the lower part of a catchment, being naturally muddy bottomed or gravel, may be more of a depositional environment where bottom dwelling organisms are smothered by the sediment deposition.

The main issue with construction and site vegetation clearance is that increased sediment loads can destroy aquatic habitat by filling in pool areas in the upper portion of streams and filling in entire stream or river lengths in the lower systems that are characterised by slight slopes at the bottom of catchments.

Streams and rivers can be considered stable if the boundaries are relatively stable and the water flow and sediment load are in balance. With excessive sediment loads, water clarity is diminished, which reduces light penetration. Water plants and algae need light for photosynthesis and reduced light penetration will reduce plant growth rate.

In addition, macroinvertebrate communities are particularly vulnerable to deposited sediment as the composition of the stream or riverbed is a major factor contributing to their distribution. Typically streams subjected to increased sedimentation have a less diverse macroinvertebrate population diversity and abundance.

**Figure 3-2**  
**Typical Stream Profile showing Steep Slope in Headwater and Shallow Slope at Stream Outlet**

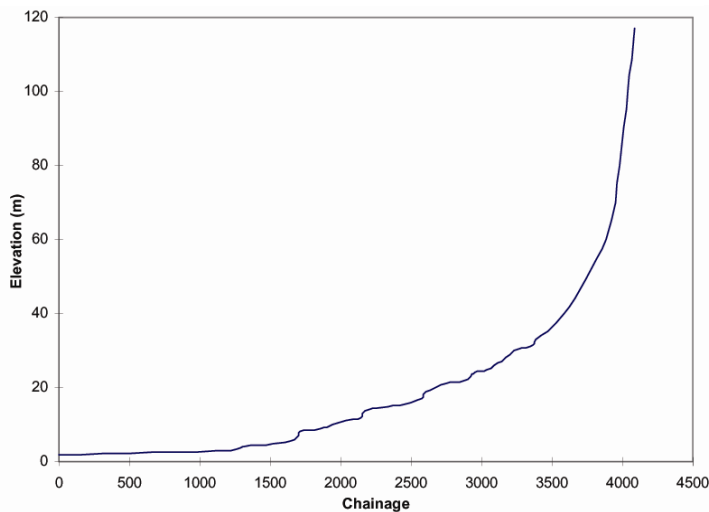

**Stream Filled with Sediment Derived from Construction Activity**



**Stream Having a Very High Sediment Load**



Macroinvertebrates, such as caddisflies, stoneflies and mayflies, which like to live in clean gravel beds, become less abundant. Worms and midge larvae, which prefer finer sediment, become more abundant (Water and Rivers Commission, 2000).

Suspended sediment can be abrasive and may damage the fine gills and mouth parts of macroinvertebrates. It may also make it harder for predatory macroinvertebrates to see their food.

From a fisheries context, many fish use stream and river pools for habitat. The loss of these pools due to sediment infilling may cause local reductions in fish population. Excess sediment may also influence the availability of food for fish. Some fish species such as gobies, feed partially on algae, while others have a diet of macroinvertebrates. Increased sedimentation may adversely affect local fish populations.

Excess sedimentation can have significant impacts on native fish. Sediment impacts fish through physical effects and indirectly through impacts on habitat and food supply. Suspended sediment can cause gill damage, limit fish growth and make fish susceptible to disease. Sediment deposition limits the amount of habitat available for spawning and can reduce the viability of egg survival. Sediment can also alter the macroinvertebrate community in favour of less preferred food items for some species (Clapcott et. al, 2011).

Another sub-category of streams are ephemeral and intermittent streams. Ephemeral streams flow only during and immediately after precipitation while intermittent streams flow for part of the year. A recent study (Parkyn, Wilding, Croker, 2006) has stated that small headwater streams contain aquatic invertebrates in all habitats including mud. Additional taxa were found in the temporary headwater habitats that were not present in perennial streams, and this suggests that these areas contain specialist species that do not occur commonly in perennial streams. As such, these streams should be considered as streams in the context of receiving systems.

Streams and rivers are sensitive to sediment deposition.

### 3.1.2 Wetlands

Wetlands are complex natural systems and are areas where slopes are slight to the point that water, either surface or subsurface, moves slowly. There is a wide range of wetlands including surface and subsurface and also seasonal wetlands. The RMA defines wetlands as ‘permanently or intermittently wet areas, shallow water, and land water margins that support a natural ecosystem of plants and animals that are adapted to wet conditions’. They provide many important benefits.

QEII Wetland, SH1, Greater Wellington Region

Wetland importance relates to:

- Attenuation of flood flows,
- Maintenance of water quality, and
- Support for native plants and animals

Being shallow water systems, wetlands are very susceptible to sediment infilling them as shown in the adjacent picture. In general, all wetlands eventually fill in and become uplands but that process may normally take many years while sediment inflow from upstream earthworking sites can fill them in very quickly.

It has been estimated that New Zealand has lost an estimated 87% of its freshwater wetlands (Te Ara Encyclopaedia of New Zealand).

Wetlands are sensitive to sediment deposition.



## 3.2 Ground

From an erosion and sediment control context discharge to ground needs to be carefully considered when there are:

- Adjacent properties that could be impacted, or
- There is karst geology.

### 3.2.1 Adjacent properties

Adjacent properties can be a receiving system. Sediment laden runoff can exit a property and be deposited on adjacent land. Care must be taken when doing earthworks to minimise potential adverse effects to the adjacent ground.

Consideration of adjacent property needs to be considered on a case-by-case basis so a general sensitivity is not provided.

### 3.2.2 Karst geology

Karst geology is characterised by subterranean limestone ( $\text{CaCO}_3$ ) caves carved by groundwater. Karst geology is generally the result of mildly acidic water acting on weakly soluble limestone bedrock, which forms calcium bicarbonate. The mild acidic water begins to dissolve the surface along fractures or bedding planes in limestone rock. Over time these fractures enlarge as the bedrock continues to dissolve. Openings in the rock increase in size and an underground drainage system develops, which allows more water to pass through the area accelerating the formation of underground karst features. The mildly acidic water results from rain passing through the atmosphere picking up  $\text{CO}_2$  which dissolves in the water. Once the rain strikes the ground it may pass through soil having more  $\text{CO}_2$  and forming a weak carbonic acid which dissolves calcium carbonate.

Within karst landscapes there is clear evidence that alteration of vegetative communities of any sort can lead to substantial and potentially irreversible impacts on the karst processes operating in that area (Urich, 2002).

Most dissolving of limestone happens just beneath the soil. This is where carbon dioxide is generated by soil microbes, so percolating water has its highest level of carbon dioxide. Some 90% of dissolving can occur in the top 10 metres of the limestone outcrop.

Problems in karst areas can also result from transport of sediment from upslope non-karst catchment areas into karst geology.

Environmental issues related to earthworks in karst terrain include:

- Soils are moderately to poorly permeable, yet there is little surface runoff. Thus rainwater is diverted underground through sinkholes and/or by diffuse recharge through the overburden into numerous small fractures in the limestone.
- Contaminants can pass rapidly through the subsurface system with little or no modification other than advective dissipation.
- Long residence times, confined aquifers and lack of natural filtration create special needs regarding groundwater protection in karst, particularly where groundwater resources are used by local communities.
- Accelerated erosion and changes to water flow paths can result in flooding, subsidence or ground collapse.
- Karst areas may be of particular cultural and spiritual significance.

Key elements to disturbance on karst geology are to:

- Minimise site disturbance and changes to soil profile including cuts, fills, excavation and drainage alteration.
- Sediment retention ponds should only be used as a last resort after all other erosion and sediment control options have been considered and rejected. In the rare instance they are employed they should serve small catchment areas (<2 ha) and be located away from known karst geology.
- Where possible, runoff should be maintained as sheet flow to avoid it becoming concentrated with flows dispersed over the broadest area possible to avoid ponding, concentration or soil saturation.
- Avoid changing flow patterns and volumes entering subterranean systems.
- Do not direct stormwater into caves/tomos/sinkholes.

Acid rock drainage is another bio-geochemical process that can naturally alter water quality but can be greatly exacerbated by disturbance, particularly from earthworks. Acid rock drainage occurs where sulphitic minerals are common and weathering reacts to release acid and other contaminants such as heavy metals.

Earthworking in karst areas has a high potential effect on the karst geology.

### 3.3 Estuaries

Estuaries are low energy, depositional zones where the sea meets streams. They tend to be semi-enclosed coastal bodies of water with one or more rivers or streams flowing into them and with a free connection to the sea. Estuaries are often associated with high rates of biological productivity. They are among the most productive ecosystems in the world and they provide rich feeding grounds for coastal fish and migratory birds and spawning areas for fish and shellfish.

Estuaries are a transition area between fresh water riverine systems and saline ocean environments and are subject to both freshwater and marine influences, including fresh water inflow and sediment entry. They tend to be shallow systems and are subject to severe degradation from land based activities. Due to very shallow gradients and significant tidal

**Highway Construction Immediately Upstream from the Okura Estuary**



**Highway Construction Adjacent to the Pauatahanui Estuary near Porirua**



influence they tend to be depositional areas subject to rapid infill due to sediment entry. In addition to the sediment being deposited due to low transporting energy, estuaries reduce sediments through flocculation where salts combine with clay materials to enhance deposition of fine sediments.

From a New Zealand perspective, estuaries seethe with bacteria, mud worms, crabs, migrating fish, mangroves and oystercatchers. This system has evolved in the mud flats and is vulnerable to time, tide, erosion, contamination and other effects of human activity. There are about 300 estuaries distributed around New Zealand's coast. Most are small (< 200 hectares) with the largest being the Kaipara Harbour at 15,000 hectares.

An estuary is typically the tidal mouth of a river and they are often characterised by sedimentation from silts carried from terrestrial runoff. They are made up of brackish water. Estuaries are marine environments, whose pH, salinity, and water level are varying, depending on the tributaries that feed them and the ocean that provides the salinity. Figure 3-3 shows a schematic of the Mahurangi Estuary and where deposition of various sized sediments occurs. The colour scheme relates to moisture content of the sediments that were cored. Higher moisture content relates to finer sediments while lower moisture content relates to coarser sandy sediments (Gibbs, 2006). The purpose of the representation is to show that fine sediment deposition will tend to be in the upper portions of estuaries.

A study of areas of estuarine sediment buildup (Vant et.al., 1993) provided an indicative estimate of sediment build-up and consideration of the area of impact. Information on this is sparse and an estimate of depositional area was done by mimicking estuary performance to pond sedimentation. In addition to sedimentation, flocculation and absorption can occur. That report estimated that approximately 75% of incoming sediment would be deposited and concentrated in approximately 3-4% of the estuary catchment area while the remainder would spread throughout the estuary.

Due to estuaries being low energy environments and having a high salinity, they are depositional zones where construction derived sediments become deposited. Similarly to wetlands, estuaries are a temporary feature. Sediments carried by rivers and tides bringing in sand will fill an estuary so that eventually it becomes an upland. The key point is that a natural process may take hundreds of years while accelerated sedimentation can fill an estuary in several years. The physical effects of catchment soil erosion will be greatest in the tidal creeks at catchment outlets, whereas the ecological effects of increased fine sediment loads will be more critical in the main body of estuaries (Swales et.al., 2002).

One final point on estuaries is that projects must meet the requirements of the applicable regional coastal plan and the possibility that a given receiving system may have a higher level of protection.

Estuaries are very sensitive to excessive sedimentation.

**Figure 3-3**  
**Sediment Size Related Depositional Zones in the Mahurangi Estuary**

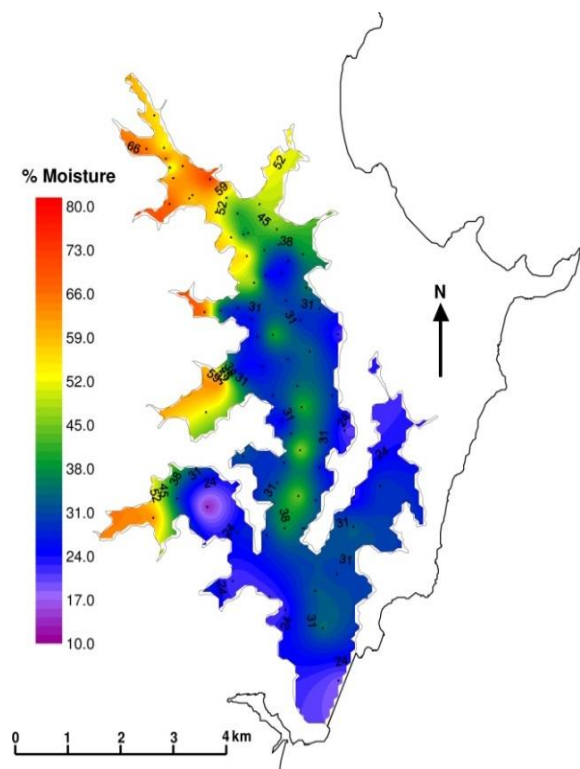

### 3.4 Harbours

Harbours are primarily natural landforms where a body of water is protected and deep enough to furnish anchorage for ships. They differ from estuaries in that tidal action is greater and rates of deposition of sediments are less. Sedimentation does still occur and most harbours of the world require dredging to maintain shipping channels.

From a water quality perspective, harbours are not as sensitive as estuaries and streams from a sedimentation standpoint.

**Marina Infilling by Sediment from Upstream Earthwork Activities**



**Tauranga Harbour**



Ecological monitoring of the Central Waitemata Harbour (Townsend, Lundquist, Haliday, 2008) has provided some indication of the sediment particle sizes and has found that harbour sediments are predominantly in the fine sand, medium sand category and mud ranges between 2-3%. A major study conclusion is that grain size is not a predominantly controlling factor in aquatic community composition as changes are occurring to those communities but particle size distribution has shown minimal change during the same period. Conversely, work done in Tauranga Harbour (Park, 2009) has shown much higher percentages of mud, which would indicate that the Tauranga Harbour has different flushing capabilities in comparison to the Waitemata Harbour.

Work done in the Whaingaroa Harbour (Swales et.al., 2005) has indicated that resuspension of harbour sediments and transport of those sediments to off-shore areas may limit sedimentation rates in the harbour. Thus, the harbour has a fairly low trapping efficiency.

Based on studies done to date, harbours are not as sensitive as estuaries and streams to impacts from sedimentation. Studies though have indicated that harbours will have individual flushing capability and in some situations, having high deposition rates, should be considered as estuaries and thus have a higher design standard.

A final point on harbours is that projects must meet the requirements of the applicable regional coastal plan and the possibility that a given receiving system may have a higher level of protection.



### 3.5 Open coasts

Open coasts are the line of demarcation between the land and the ocean. They are dynamic environments and go through constant change. Natural processes, particularly sea level rise, tidal energy, waves and various weather conditions have resulted in erosion, accretion and reshaping of coasts as well as flooding and creation of continental shelves and drowned river valleys.

Coasts face many environmental challenges relating to human-induced impacts. The human influence on climate change is considered to be a major factor of the accelerated trend in sea level rise. In addition, urban development of coastal land contributes to litter problems and reduced natural coastal habitat.

While not as serious as sedimentation issues in streams, estuaries or harbours sedimentation can be an ongoing concern on coasts with sediment plumes creating visual pollution, impacting on light penetration and potential adverse impacts on coastal reef communities. A large part of the global population inhabits areas near the coast, partly to take advantage of marine resources but also to participate in activities that occur adjacent to coastal marine areas.

Consideration of sedimentation issues on off-shore areas is difficult to assess as much less is known about the various modes and mechanics of transport to be able to make an accurate assessment of potential impacts. There are issues related to littoral drift and off-shore sediment transport along, towards or away from the coast. There are few studies that have documented these effects.

The same study from the previous subsection on harbours that considered the Whaingaroa Harbour (Swales, et.al., 2005), also found the presence of clay minerals in continental-shelf sediments that were eroded from catchment mudstone and LANDSAT images showed fine-sediment plumes extending up to 20 km off-shore from the harbour mouth.

While not being as sensitive as other receiving systems to sedimentation, there are still concerns regarding sediment discharge to open coastlines.

A final point on open coasts is that projects must meet the requirements of the applicable regional coastal plan and the possibility that a given receiving system may have a higher level of protection.

State Highway 6



**Turbidity in Open Coastal Discharge Due to Sediment Delivery**



### 3.6 Lakes

A lake is a body of water that is contained in a body of land and, in the context used here, contains fresh water. Most lakes have an outfall but some do not. Lakes can be manmade or natural. The variety of lakes includes the following (Te Ara Encyclopaedia discussion of New Zealand lakes):

- Glacial lakes in the higher country of the South Island,
- Volcanic lakes that are largely confined to the Taupo Volcanic Zone and the area around Auckland,
- River, dune, landslide and coastal barrier lakes that are all formed by natural processes that change the drainage and cause water to pond up, and
- Artificial lakes that are man-made.

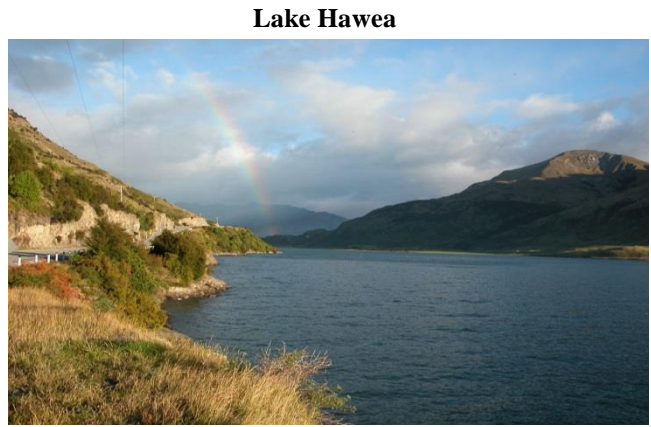

Lakes trap sediments that enter them as the sediment drops to the lake bottom. Having very low horizontal velocities through lakes results in a high degree of sedimentation as sediment particles drop out of suspension due to gravity. Over time lakes become shallower and may eventually fill in.

The annual rate of sedimentation in New Zealand lakes varies between 1-200 mm/year. The highest are in reservoirs due to the inflow travelling through highly eroded land and the inflow carrying a high sediment load (TeAra Encyclopedia of New Zealand)

Figure 3-4 Causes of Lake Stressors in the U.S.

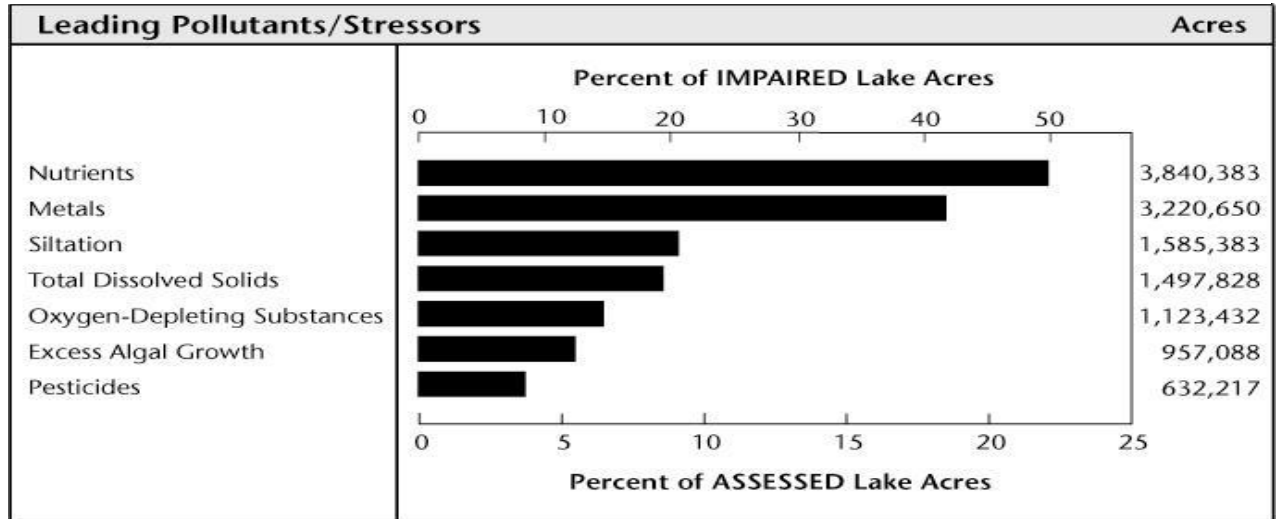

Due to lower horizontal velocities, materials that enter a lake tend to remain in the lake. They are, in effect, sinks where contaminants can accumulate. The following lake information in Figure 3-4 from the U.S. provides an indication of the causes of stressors in U.S. lakes. As can be seen, siltation is the third greatest stressor on lake health. The impact on shallow lakes would be correspondently greater as less storage in the lake could result in significant impacts.

In a similar fashion to lakes in the U.S., New Zealand lakes are primarily impacted by nutrients. Sediment can also reduce lake clarity and on state highway projects, the primary cause of sediment discharges relates to erosion and sediment control during construction.

NIWA reported on lake water quality (NIWA, 2006) and summarised the current status of 121 lakes. The land use that drained to the lakes was related to four land-cover classes: alpine, native forest/scrub, exotic forest, and pasture. Urban land uses were not identified nor considered. NIWA considered phosphorus, nitrogen, clarity, suspended solids and temperature. Median values of total nitrogen, total phosphorus and *chlorophyll a* were four to six times higher in pasture classes than in native bush.

The broad national picture is of high water quality in deep lakes at high altitude and in unmodified catchments, and of lower water quality in modified catchments, especially in small, shallow and warm lakes. Although lake water quality was degraded in both exotic forest and pastoral catchments, pastoral use was associated with the worst water quality, most notably in the cases of extreme deterioration.

Extrapolation of the lake environment categories to the nationwide database of 3,820 lakes suggests that approximately 60% of New Zealand lakes are still likely to have excellent or very good water quality; these are lakes in cold regions with high native and low pasture cover. However, approximately 30% of lakes are likely to have very poor to extremely poor water quality. Lowland lakes are especially likely to have poor water quality.

In terms of sensitivity to sedimentation, lakes would be considered as having a potentially moderate sensitivity to impact. The sensitivity may be greater in those situations where lake water levels are maintained by groundwater seepage from the lake. Any increase in sediment load can seal off seepage areas, causing lake levels to rise and possibly increase adjacent flooding potential. In those situations sensitivity would be high.

### 3.7 Overall discussion of erosion and sediment control related to receiving environments

To put the previous discussion into a context for sediment laden runoff, the following Table 3-1 provides a brief snapshot of receiving environments and their susceptibility to adverse effects from sedimentation. The Table is meant as a general guide and does not substitute for regulatory requirements required by consenting authorities. Contact should be made with the appropriate council to ensure that local requirements are complied with.

**Table 3-1 Receiving environments and sedimentation issues**

Receiving system	Water quality
Estuaries	Highest potential effect
Streams, rivers and wetlands	High potential effect
Karst geology	High potential effect
Lakes	Moderate potential effect
Harbours	Lower potential effect
Open coast	Lower potential effect

Variation in criteria will be discussed in Section 5 Selecting a Management Approach in conjunction with Section 6 Hydrological Design Approach where risk will be assessed along with appropriate storm sizing. The combination of these two sections will provide guidance on what practices are appropriate for projects that drain into the various receiving systems.

In terms of the ultimate receiving environment that decision needs to be made on individual projects and should depend on the area downstream most susceptible to sediment deposition. If a project discharges to a stream, then a large capacity lake and finally to an estuary, the lake minimises discharge of sediment to the downstream estuary so the stream being initially discharged to forms the basis for sizing of sediment retention structures.

## 4. Erosion and sediment control concepts

The overarching principle of erosion and sediment control on earthworks sites is to limit sediment detachment, transport and deposition. As a number of factors (e.g. rainfall intensity, site soils) are beyond our control, it therefore falls to applying the most appropriate solution for the circumstances. As there are numerous devices at our disposal, the integration of as many concepts as possible provides the most effective erosion and sediment control on site (Georgetown County, 2006).

These concepts are typically formalised through the use of erosion and sediment control practices detailed in an Erosion and Sediment Control Plan (ESCP) prepared for the land disturbing activity.

### 4.1 Advantages of erosion and sediment control

With careful pre-planning, erosion and sediment controls usually result in many on-site advantages in addition to protecting the environment.

Environmental benefits include:

- Reduced risk of damage to aquatic ecosystems,
- Improved appearance of the site and downstream waters,
- Reduced water treatment costs,
- Reduced blockage of drains, and
- Less mud dropped or washed onto roads.

On-site benefits can typically include:

- Improved drainage and reduced site wetness as a result,
- Less dust problems,
- Improved working conditions,
- Reduced downtime after rain,
- Less stockpile losses,
- Reduced clean-up costs,
- Earlier works completion, Less chance of public complaints, and
- Less regulatory intervention.

### 4.2 Concepts and principles of erosion and sediment control

Implementation of erosion and sediment controls is required to avoid, remedy or mitigate the effects of earthworks on the receiving environment. To ensure that erosion and sediment controls are effective and cost efficient, an understanding of the basic principles of erosion and sediment control is required, as is ensuring that erosion and sediment control practices are considered and carefully managed throughout the project's planning, design and construction phases (Environment Canterbury, 2007).

State highway project's construction timeframes may take longer to construct than other types of construction projects, and the resulting longer operational life of many erosion and sediment controls, requires a stronger emphasis on some management concepts (Department of Environment and Climate Change NSW, June 2008), particularly:

- The control of upper catchment water,
- Separation of clean from dirty water,
- Protecting the land surface from erosion, and

- Preventing sediment from leaving the site.

The following concepts are therefore relevant when designing an ESCP for a state highway project site.

#### 4.2.1 Control upper catchment water

Upper catchment water is runoff from above the area of disturbance that would normally flow through the site. The key consideration in reducing the contributing catchment is to control this clean water by interception, diversion and safe disposal to a location below the area of disturbance as shown in Figure 4.1.

Reducing the area of the catchment contributing to water flowing through the site will reduce the volume of water to be treated thereby minimising the sizing of any controls.

**Figure 4-1**  
Diversion of clean water from above the site (Goldman et al 1986)

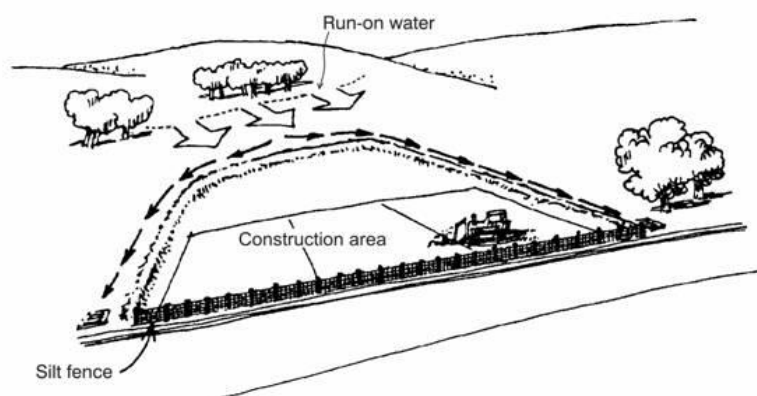

#### 4.2.2 Separate clean from dirty

Clean water is water that has not flowed through disturbed areas whilst discharges from disturbed areas are considered to be dirty water. Minimising the volume of water that is required to be treated by a sediment control device saves space and money. Furthermore clean water (upper catchment water that does not flow through the disturbed area) has not been contaminated by sediment, therefore does not require treatment. Practices to achieve this are outlined in Section 7 of this standard.

**Diversion separating the clean water from the dirty water**



#### 4.2.3 Reduce the area available for erosion

To minimise the rates of soil loss, techniques as outlined in section 8 of this standard will assist however, protecting the land surface from erosion can be as simple as:

- Project design taking into account terrain limitations,
- Project scheduling to known climatic and soil variations,
- Minimising land clearance,
- Limiting areas of disturbance, and
- Progressively stabilising disturbed areas (e.g. grassing, landscaping and mulching)

**Erosion Control – Mulching**



## 4.2.4 Minimise sediment from leaving the site

Sediment laden water (dirty water), as discussed in previous sections, can have a variety of impacts if not managed in accordance with best practice. Therefore it is imperative that a suite of controls are used on state highway construction projects. Sediment controls should be selected taking into account the site constraints and receiving environment, and steps should be taken to ensure that the controls are integrated with the permanent features of the project. Refer to the practices outlined in section 8.

### Sediment Control Practices



## 4.3 The role of erosion and sediment controls

Erosion and sediment controls have different roles on an earthworks site. Erosion controls seek to minimise any sediment from being mobilised whilst sediment controls attempt to remove sediment from suspension once entrained. The analogy of erosion controls (fence at the top of the cliff) whilst sediment controls (ambulance at the bottom of the cliff) is applicable in describing their roles.

Any ESCP should place initial emphasis on erosion control although in many circumstances this may not be achievable.

### 4.3.1 Efficiency vs effectiveness of practices

The ability of an erosion and sediment control practice to prevent sediment from being transported or to remove sediment once entrained is a measure of its efficiency. This efficiency (as a %) can be represented as the volume removed when measured against the volume of sediment that arrives at the practice. Depending on a range of factors the removal efficiency can range from 50% to 75%.

Efficiency should not be confused with effectiveness. The effectiveness of a specific practice takes into consideration other factors such as the timing, cost, sensitivity of receiving environment and placement location of the device. For example, a sediment retention pond placed in an area that receives little or no water is still an efficient practice but is not an effective measure for that particular site.

## 4.4 The treatment train

A treatment train comprises a series of best management practices and/or natural features, each planned to treat a different aspect of pollution prevention, that are implemented in a linear fashion to maximise pollutant removal. This approach is directly applicable to the control of sediment on state highway projects.

Erosion and sediment control measures should generally be planned to link functionally to form a “treatment train” with each measure having a specific role within the framework of surface water management, soil protection and stabilisation, and sediment capture. This approach can be a combination of structural (e.g. sediment ponds, perimeter controls) and non-structural (e.g. earthworking season) practices.



This approach needs to be considered during the early phases of project planning, and followed through to the completion of the project. Section 5 of this document will detail how to select the appropriate tools to ensure that this approach occurs.

## 4.5 Principles to follow

These ten principles (best practice principles) build upon the previous concepts and provide guidance for erosion and sediment control through the planning, construction and maintenance phase of a project.

**Table 4-1 Erosion and Sediment Control Best Practice Principles**

Principle	Description
1. Minimise Disturbance 	<p>Consider the land sensitivity in forming the earthworks and construction methodologies/techniques. This may be difficult from a state highway perspective where space is limited but the concept should always be considered.</p> <p>Some parts of a site should never be worked and others need very careful working. Watch out for and, if practicable, avoid areas that are wet (streams, wetlands and springs), have steep or fragile soils or are conservation sites or features.</p> <p>Bear in mind a minimum earthworks strategy and only clear areas required for structures or access.</p> <p>Show all limits of disturbance on the ESCP. On site, clearly show the limits of disturbance using fences, signs and flags.</p>
2. Stage Construction	<p>Carrying out bulk earthworks over the whole site maximises the time and area that soil is exposed and prone to erosion. “Construction staging”, where the site has earthworks undertaken in small units over time with progressive revegetation, limits erosion.</p> <p>Careful planning is needed. Temporary stockpiles, access</p>

	<p>and utility service installation all need to be planned. Construction staging differs from sequencing. Sequencing sets out the order of construction to contractors. Detail both construction staging and sequencing in the ESCP.</p>
<p>3. Protect Steep Slopes</p> 	<p>Where possible avoid existing steep slopes. If clearing of steep slopes is necessary, runoff from above the site can be diverted away from the exposed slope to minimise erosion. If steep slopes are worked and need stabilisation, traditional vegetative covers like topsoiling and seeding may not be enough - special protection is often needed. Highlight steep areas on the ESCP showing limits of disturbance and any works and areas for special protection.</p>
<p>4. Protect Watercourses</p> 	<p>Existing streams and watercourses, and proposed drainage patterns need to be mapped. Resource consent may be required for clearance works adjacent to a watercourse.</p> <p>Map all watercourses and show all limits of disturbance and protection measures in the ESCP. Also, the ESCP should show all practices to be used to protect new drainage channels. Indicate crossing or disturbances and associated construction methods in the ESCP.</p>
<p>5. Stabilise Exposed Areas Rapidly</p> 	<p>An important objective is to fully stabilise disturbed soils with vegetation after each stage and at specific milestones within stages. Methods are site specific and can range from conventional sowing through to straw mulching. Mulching is the most effective instant protection.</p> <p>In the ESCP clearly define time limits for grass or mulch application, outline grass rates and species and define conditions for temporary cover in the case of severe erosion or poor germination.</p> <p>The requirements for the project landscaping should also be considered when stabilising sites. This may require the erosion and sediment control specialists to integrate their approach with the landscape architects. Further information is available in the the Transport Agency Landscape Guidelines (2014).</p>
<p>6. Install Perimeter Controls</p> 	<p>Perimeter controls above the site keep clean runoff out of the worked area - a critical factor for effective erosion control. Perimeter controls can also retain or direct sediment laden runoff within the site. Common perimeter controls are diversion drains, silt fences and earth bunds. Detail the type and extent of perimeter controls in the ESCP along with the design parameters for those controls.</p>



## 7. Employ Detention Devices



Even with the best erosion and sediment practices, earthworks will discharge sediment laden runoff during storms. Along with erosion control measures, sediment retention structures are needed to capture runoff so sediment generated can settle out. Sediment retention ponds are often not highly effective in areas with fine grained soils. In those areas it is necessary to ensure the other control measures used are appropriate for the project and adequately protect the receiving environment.

Include sediment retention structure design specifications; detailed inspection and maintenance schedules of structures and conversion plans for permanent structures, in the ESCP.

## 8. Experience and Training



A trained and experienced contractor is an important element of an ESCP. Contractors are individuals responsible for installing, maintaining and decommissioning erosion and sediment control practices.

Critical on-site staff should go through an erosion and sediment control training programme that may be available either locally or elsewhere in New Zealand. The transport Agency also has an e-learning module on erosion and sediment control. Better knowledge can save project time and money, by allowing for identification of threatened areas early on and putting into place correct practices.

Making arrangements for a pre-construction meeting, regular inspection visits, and final inspection is also important.

## 9. Make Sure the Plan Evolves

An effective ESCP is modified as the project progresses from bulk earthworks to permanent drainage and stabilisation. Factors such as weather, changes to grade and altered drainage can all mean changes to planned erosion and sediment control practices.

Update the ESCP to suit site adjustments in time for the pre-construction meeting and initial inspection of installed erosion and sediment controls, and make sure it is regularly referred to and available on site.

## 10. Assess and Adjust

Inspect, monitor and maintain control measures.

Assessment of controls is especially important following a storm. A large or intense storm will leave erosion and sediment controls in need of repair, reinforcement or cleaning out. Repairing without delay reduces further soil loss and environmental damage.

Assessment and adjustment is an important erosion and sediment control practice -make sure it figures prominently in the ESCP. Assign responsibility for implementing the ESCP and monitoring control measures as the project progresses.

The ESCP should also be integrated with the Environmental and Social Management Plan, therefore, reducing duplication in the site specific environmental aspect management plans.

## 5. Selecting a management approach

This section builds on previous ones that have discussed the philosophy of erosion and sediment control. The section expands upon the discussion by providing more information regarding performance of erosion and sediment control practices, their applicability and limitations. Having knowledge of practice applicability and limitations can provide the basis for developing an effective ESCP to be implemented on a site-by-site basis.

The first consideration on any construction site is prevention of erosion from occurring. This could entail a strategy of phasing project work to minimise the bare areas that are exposed at any one time. Recognising that the purpose of earthworking is to facilitate state highway construction, elimination of bare soils will not be possible and necessary site exposure entails the implementation of sediment control practices to capture sediment in transit and reduce its movement into receiving environments.

The overall goal is to reduce on-site erosion and off-site sedimentation by the use of both erosion control and sediment control practices. These practices draw upon the concepts discussed in Section 4 of the Standard.

**A Good Example of Project Phasing and Use of Multiple Practices to Reduce Sediment Discharge. Notice Stabilisation of Embankment as Grades Go Up.**



Each of these will be discussed in subsections 5.1 to 5.4.

### 5.1 Erosion control

Erosion control practices will be discussed in detail in Section 8 and they include a variety of practices to minimise site erosion potential. A range of practices include:

- Runoff diversion channels to divert clean upslope water from a construction area,
- Contour drains on a construction area to divert sheet flow into channels that reduce rill or gully erosion,
- Providing slope benches to prevent flow from concentrating and eroding slopes,
- Rock check dams to reduce velocities in channels and thus prevent erosion,
- Temporary or permanent seeding,
- Hydroseeding,
- Mulching bare areas with straw or other suitable materials,
- Placement of turf on bare areas,
- Geosynthetic erosion control blankets,
- Stabilised construction entrances to reduce erosion potential at site access points,
- Pipe/flume drop structures to convey water from the top of a slope to the bottom,
- Level spreaders,
- Phasing of construction to limit exposed areas at any one time,
- Site speed limits, and
- Surface roughening.

All of these practices function to prevent or minimise site erosion. Table 5-1 provides some discussion on the efficiency of erosion control practices at sedimentation reduction where such information is available. These values are indicative only and actual performance would vary depending on site conditions, and how well the device is constructed and maintained.

**Table 5-1 Efficiency of erosion control practices at sedimentation reduction**

Practice	Performance for sediment reduction
Runoff diversion channels	Not a sediment removal practice but used as an effective transport mechanism.
Contour drains	Not a sediment removal practice but used to minimise flow across bare soil areas.
Slope benches	49% less erosion than a uniform slope (Zhu, Dabney, Flanagan, 1999)
Rock check dams	They do not remove significant amounts of sediment but reduce channel velocities to prevent channel scour
Temporary or permanent seeding	90+% (Fifield, 1999)(ARC field study, 1998)
Hydroseeding	50-60% (Caltrans, 2002)
Mulching with straw or other suitable material	53-99% (Harding, 1990)
Placement of turf	98-99% (EPA, 1993)
Geosynthetic erosion control blankets	Depends on fabric and proper installation
Stabilised construction entrance	Does not remove sediment but reduces potential for sediment to be generated at site access points.
Pipe/flume drop structures	There is no information on the effectiveness of pipe slope drains to prevent erosion
Level spreaders	It is not a sediment removal practice but rather a practice to disperse water flow and avoid concentration of flow
Phasing of construction	42% reduction (Claytor, 1997)
Site speed limits	No information available
Surface roughening	18% (Dane County, 2007)

Looking at the performance of erosion control practices, stabilisation (i.e. seeding, hydro-seeding, mulching, turf and erosion control matting) is the single most important element in reducing erosion potential. Other practices need to be considered but their benefits are more incremental. The cumulative effect of a number of erosion control practices provides significant benefit and reduces the amount of work that sediment control practices will have to do.

## 5.2 Sediment control

Sediment control practices will also be discussed in Section 8 and include a variety of practices to trap sediment. The practices for which detailed design is provided in Section 8 include:

- Sediment retention ponds without chemical treatment,
- Sediment retention ponds with chemical treatment,
- Silt fence,
- Super silt fence,
- Filter socks,
- Storm drain inlet protection,
- Decanting earth bund, and
- Sump/sediment pit.

All of these practices provide for sediment removal from surface runoff. Table 5-2 provides some discussion on the efficiency of sediment control practices to reduce sediment loads, again where such information is available. These values are indicative only and actual performance would vary depending on site conditions and how well the device is constructed and maintained.

**Table 5-2 Efficiency of sediment control practices to reduce sediment loads**

Practice	Performance for sediment reduction
Sediment retention pond (no chemical treatment)	50-80%
Sediment retention pond (w/chemical treatment)	75-95%
Silt fence	40-75% depending on type of fabric, overflow rate and detention time (Barrett et al., 1995)
Super silt fence	No data available
Filter socks	62% - 87% depending on sock fill material (straw, compost, PAC)
Storm drain inlet protection	No information available. When filter fabric is used, performance could be similar to silt fence performance
Decanting earth bund	60% depending on sizing of device and rainfall intensity
Sump/sediment pit	No data available

Performance data indicates that regardless of best intentions and performance, sediment will be discharged downstream. Sediment control practices cannot remove 100% of incoming sediment from the water column. The key element is to reduce the magnitude and frequency of sediment discharge by a combination of erosion control and sediment control practices.

### 5.3 Practice applicability and limitations

Recognising the performance of erosion and sediment control practices, it is important to consider where they are applicable and what their limitations are. Table 5-3 provides information on applicability and limitations. Section 8 provides detailed discussion of practice applicability and limitations. Table 5-3 provides only a general overview.

**Table 5-3 Erosion and sediment control practice applicability and limitations**

Practice	Applicability	Limitations
<b><i>Erosion Control Practices</i></b>		
Runoff diversion channels	To divert upstream catchment areas either away from bare soils or to convey sediment laden runoff to sediment storage practices	Limit to channel grades < 2% Limit catchment areas < 2 ha
Contour drains	To intercept and convey overland flow on disturbed areas to reduce overall slope length.	Limit channel grades < 2% Catchment area to each contour drain < 0.5 ha
Slope benches	Where slopes exceed 25%	Limit channel grades < 2% Limit catchment areas < 0.5 ha
check dams (rock or filter socks)	Velocity reduction in channels	Not for use in perennial flow streams. Catchment area < 1 ha
Temporary or permanent seeding	To stabilise the soil and prevent erosion. Can be used on an interim basis prior to final grade being reached	Suitable for any size disturbed area
Hydroseeding	For use on steep slopes or on bunds or batters.	No limitation but primary use would be on difficult sites where reaching certain areas with conventional seeding is difficult.
Mulching with straw or other suitable material	Instant protection of soil from raindrop impact	Needs to be crimped on steeper slopes to prevent sloughing.

Placement of turf	To provide immediate permanent ground cover on critical areas.	No limitation but steeper slopes may require pegs to prevent slippage.
Geosynthetic erosion control blankets	Immediately reduces erosion by coverage and degradable fabric allows seed to pass through the fabric for permanent stabilisation. Permanent fabric can also provide long term erosion protection.	No limitations
Stabilised construction entrance	Use on all access points to a site to prevent those points from becoming a source of sediment.	It is not a sediment removal practice.
Pipe/flume drop structures	Excellent means to get water from the top of a slope to the bottom without causing slope erosion.	Minimum pipe slope of 3% Maximum catchment area of 1 ha
Level spreaders	Converts concentrated flow to dispersed sheet flow to reduce erosion potential.	Downstream slope < 10% Very hard to get exactly flat which is needed to ensure dispersed flow
Phasing of construction	Primarily for larger sites where disturbed areas can be minimised through project staging.	If there is a significant seasonal variation in rainfall, it may be better to work as much of the site as possible prior to the rainy season In general, small sites do not lend themselves to phasing
Surface roughening	To increase surface roughness and reduce velocities of flow down slope.	No limitations
<b><i>Sediment control practices</i></b>		
Sediment retention pond (no chemical treatment)	For treatment of site runoff in areas where concentrated flow is anticipated or where slopes and flows would overwhelm other practices	For catchment areas > 3,000 m <sup>2</sup>
Sediment retention pond (w/chemical treatment)	Same as sediment retention ponds (no chemical treatment)	Same as sediment retention ponds (no chemical treatment)
Silt fence	A barrier of woven geotextile fabric in areas of dispersed sheet flow	Cannot be used in areas where there is concentrated flow Use in areas < 0.5 ha Must be placed on the contour Length of fence is very dependent on catchment slope
Super silt fence	A barrier of woven geotextile fabric that is reinforced with chain link fencing	Capture of runoff that is sheet flow only Use in areas < 1 ha Should be placed on contour Length of fence is very dependent on catchment slope
Filter socks		Use in areas < 0.5 ha Must be placed on the contour Length of fence is very dependent on catchment slope
Storm drain inlet protection	To intercept and filter sediment runoff prior to it entering a reticulated stormwater system	Should never be a primary sediment control practice Extreme care must be taken to ensure that clogging does not cause an unintended overflow
Earth bund	Commonly used with a decanting outlet where the bund functions as a dam to temporarily hold water until the decant discharges it	Catchment area should not exceed 3,000 m <sup>2</sup>
Sump/sediment pit	Used to treat sediment from excavated areas such as bridge abutment excavations or for cofferdams	Should only be used where there is not a positive outfall and pumping or suction is needed to dewater

## 5.4 Development Lifecycle of an ESCP

An ESCP will be developed in stages during the project lifecycle to meet the requirements of the various audiences and to inform other aspects of the project and vice versa. A draft ESCP will be prepared for consenting (Section 5.4.1), the construction plan is then developed (section 5.4.2) and supported by individual method statements (section 5.4.3).

### 5.4.1 Draft ESCP for Consenting

The draft plan for consenting involves gathering, mapping and analysing information regarding the physical characteristics of the site. The site should be visited to understand the topographic, vegetative, drainage, soil and receiving system characteristics. Reliance on maps and other materials in the office is not an acceptable approach.

The topography of the site, mapped at suitable contour intervals, will allow for the identification of drainage patterns, slopes, and resources such as wetlands, streams, bush, buffers and receiving systems. Mapping the flow of water onto, through, and off the site enables the delineation of drainage areas and flow patterns. Downstream wetlands, lakes, streams, rivers, structures or other sensitive areas (sensitive to damage from sedimentation, should be investigated, mapped and incorporated into the design to afford these areas additional protection). The design should eliminate or minimise sediment movement through a sensitive area.

Investigating the site soil characteristics by geotechnical testing enables the designer to identify highly erodible soils. The concept plan should contain a narrative that describes how erosion and sediment control will be integrated into the overall stormwater management strategy.

The plan will establish the footprint of the proposed project and demonstrate how key areas of concern will be addressed when the proposed state highway project is superimposed.

This will provide decision makers with enough information to demonstrate how the Transport Agency has the ability to manage sedimentation effects on the receiving environment from the proposed project.

### 5.4.2 Construction ESCP

A construction ESCP will be developed prior to construction commencing and will be provided to the consenting authority if required as a condition of a resource consent.

The Construction ESCP shall include;

- An outline as to how the ESCP is consistent with the ten principles in section 4.5 of this guide
- a site description, including climate, soil, slope (contour information at appropriate intervals), size of disturbance, erosion and sediment control practices and, the pathway and receiving system that the project ultimately drains into.
- locality map(s) detailing as a minimum the location of roads, property boundaries, surface waterways/ water races and crossings, stormwater reticulation surfaces (existing and proposed), the direction of stormwater flows, and the erosion and sediment control devices.
- a detailed programme of works identifying;
  - each stage of construction
  - an estimate of the maximum area of bare ground (cumulative total) exposed at each stage of construction, including progressive stabilisation and minimising areas of exposed soil considerations
  - an estimate of the total length of exposed roads, trenches and tracks
  - the volume of earthworks proposed

- if applicable, a field testing programme to confirm soakage rates of the receiving ground at the location of all soakage structures proposed along the route to discharge construction related stormwater runoff to ground
- a description of the erosion control measures proposed to be utilised from section 8 of this guide
- a description of the sediment control measures proposed to be utilised from section 9 of this guide
- outline the individual method statements for the erosion and sediment controls required for each stage and the process for approving the design and construction
- a schedule of the frequency and methods of inspection, monitoring and maintenance of all erosion and sediment control measures, including any checks proposed to be undertaken after more than 15mm of rain falls in a 24 hour period
- emergency procedures that set out measures that will be implemented if there is an accidental untreated sediment discharge to surface water

The ESCP will be a sub-management plan of the Environmental and Social Management Plan for the project (see <http://www.nzta.govt.nz/network/operating/sustainably/plans.html> for more information) (NZTA, 2014).

### 5.4.3 Individual method statements

The large projects often have site specific (e.g. installation of a culvert, formation of geotechnical remediation works) method statements which link into the final plan defined above. They are often more detailed than the final plan and cover a portion of the site area within a specific phase of the project. As a general guide, they will discuss the work methodology, the timing/duration of the works, proposed environmental controls, supporting calculations and monitoring requirements. Drawings are also attached.

Whilst the final plan will form part of a consent condition, the individual method statements are used to enable flexibility with the design and construction of the specific task.

These plans need to be “user friendly” as they are the guiding document for any contractor undertaking the work. It is therefore important that the contractor is brought in at this stage of the design (or even earlier) to ensure the most optimal and practical approach is sought.

## 6. Hydrological design criteria

In terms of practice performance and relative effectiveness, much depends on the hydrological design of the practices. Hydrological design is based on the following parameters:

- Soil,
- Slope,
- Rainfall,
- Ground cover, and
- Risk associated with the design.

The effect that soil, slope and groundcover have on runoff is well understood but a key element of sizing of practices relates to rainfall and the risk associated with the design. The risk relates to the sensitivity of the receiving environments as exceedance of design criteria could have a significant impact on them. The parameters are discussed in the following subsections.

### 6.1 Soils

New Zealand has a wide variety of soils with fifteen main types. Changes in soil across the landscape are caused by different geology, vegetation, groundwater, topography and age. In a historic context soils can expect to age over time but in situations where disturbance occurs by logging, vegetation clearance, or earthworking, aging can cease and have to start again. Topography can also modify soils due to erosion occurring in steeper areas.

The main types of soil in New Zealand are discussed in Table 6-1 taken from the Landcare Research website containing Soil Orders from the New Zealand Soil Classification.

It is important to note that the soil types listed in the following table are just a guide and that there may be more detailed soil maps locally that must be used.

**Table 6-1 Soil types and properties**

Soil type	Discussion	Physical properties
Allophanic	Stiff, jelly-like minerals coat the sand and silt grains and maintain porous, low density structure with weak strength.	There is little resistance to root growth. Topsoils are stable and resist the impact of machinery in wet weather. Erosion rates are generally low except on steep or exposed slopes.
Anthropic	Constructed or drastically disturbed by people. They include soil materials formed by stripping of the natural soil, deposition of refuse or spoil or by severe soil mixing. The original character of the soil and the normal soil properties are lost.	Soil properties depend on both the nature of the manufactured or natural materials and the nature of the soil manipulation. Land surfaces are artificial and drainage has often been changed significantly.
Brown	These soils have a brown or yellow-brown subsoil below a dark grey-brown topsoil. The brown colour is caused by thin coatings of iron oxides weathered from the parent material.	They have relatively stable topsoils with well-developed polyhedral or spheroidal structure.



Soil type	Discussion	Physical properties
Gley	These soils are strongly affected by waterlogging and have been chemically reduced. They represent the original extent of New Zealand wetlands, which have been greatly restricted in area by drainage.	They have high groundwater tables, shallow potential rooting depth and high bulk density.
Granular	These soils are clayey soils formed from material derived by strong weathering of volcanic rocks or ash.	The soils are slowly permeable and have limited rooting depth. Topsoils have limited workability when wet.
Melanic	They have black or dark grey topsoils that are well-structured. The subsoil contains lime, or has well-developed structure.	Topsoil structure is usually stable. The soils shrink on drying and swell on wetting.
Organic	Organic soils are formed in the partly decomposed remains of wetland plants (peat) or forest litter. Some mineral may be present but the soil is dominated by organic matter.	These soils have very low bulk densities, low bearing strength, high shrinkage potential when dried.
Oxidic	Clayey soils that have formed as a result of weathering over extensive periods of time in volcanic ash or dark volcanic rock.	They are well developed soils and have relatively stable structure, slow permeability and moderate or rapid infiltration rates.
Pailic	The soils have weak structure and high density in subsurface horizons.	They have slow permeability and are susceptible to erosion.
Podzol	Acidic soils that usually have a bleached horizon beneath the topsoil.	Cemented or compacted B horizons (subsoil) and associated with slow permeability.
Pumice	Sandy or gravelly soils dominated by pumice or pumice sand with a high content of natural glass. Drainage is rapid.	Clay content is generally less than 10%. The soil has low soil strength, especially when disturbed.
Raw	These are young soils that lack distinct topsoil development. They occur in areas characterised by rockiness, active erosion or deposition.	Raw soils have no B horizon (subsoil) with little or no topsoil.
Recent	Weakly developed soils showing limited signs of soil-forming processes.	They have variable soil texture with common stratification of contrasting materials and variability is high.
Semiarid	These are dry soils with salt and lime accumulation in the lower subsoil.	Soil structure is usually weakly developed and the soils are erodible.
Ultic soils	The soils are acid and strongly leached and they occur in clay or sandy parent material over long periods of time.	Clayey subsoils with slow permeability and are prone to erosion.

The discussion of soils is important in that soils have variable permeability rates and sizing of sediment control practices will be based on the amount of water that runs over the soil rather than what goes into it. Due to the highly variable nature of soils, every project should have a soils analysis done to determine sedimentation needs. Soils information is needed to select a Rational Formula 'C' factor and to determine whether flocculation is required. The issue of flocculation will be discussed in Section 8.

Soils are significantly altered during site development (Pitt, Clark, Lake, 2007). These changes range from stripping off the topsoil and compacting the remaining soil, to removing large amounts of native soils in cut operations, to bringing in large amounts of new material if fill is

needed. The surface soils, which are exposed to potential erosion, can affect the amount of site runoff for different construction stages.

It is important to do the following when planning erosion and sediment control practices:

- Determine what the soils are on site.
- Determine whether soil characteristics will be changed by the earthworks.
- If fill material is brought on site, what changes will that material make to the existing soil?
- How much cut and fill will be done on site and how will the soil profile be changed?

Where compaction occurs, the effect is a significant reduction in water infiltration into the ground. This applies across the board to all soils, but to a lesser extent for sands and gravels. Examples of the infiltration rates of non-compacted and compacted soils are shown in Figure 6-1 (Pitt, Clark, Lake, 2007) that demonstrates the impact that construction equipment operation has on soil infiltration.

Figure 6-1 (Pitt, Clark, Lake, 2007)

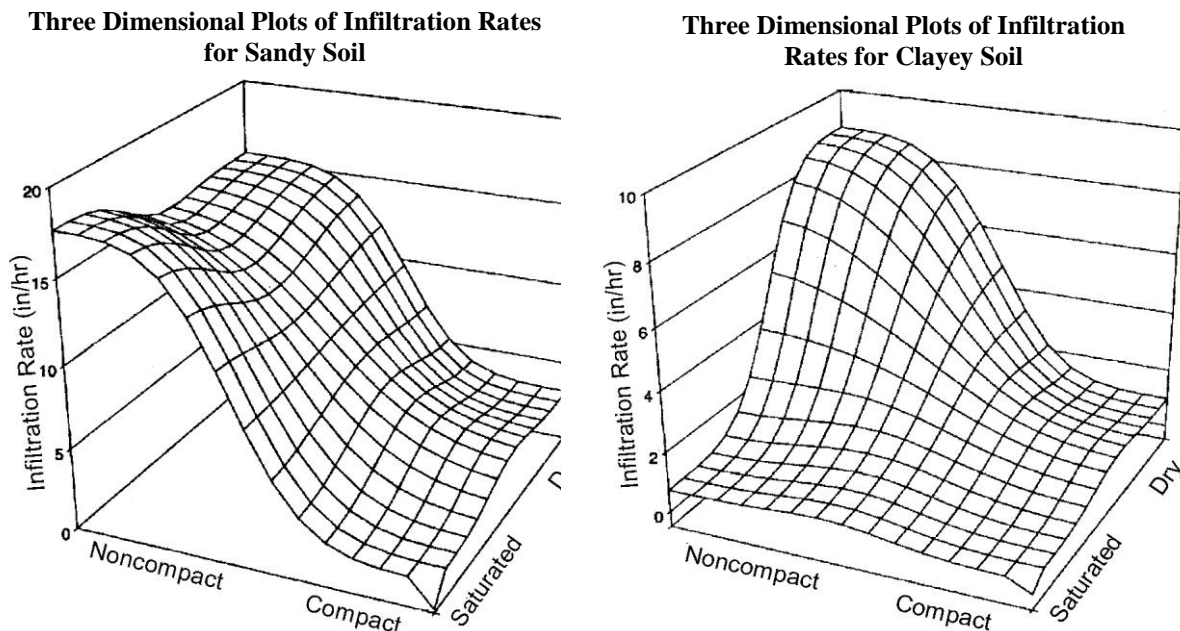

## 6.2 Slopes

Section 2.1.3 had a general discussion of slope and related sediment yield to site slope. In this subsection slope is considered from a hydrologic perspective where increases in slope increase site discharge and velocity. The easiest representation of how slope impacts on discharge and velocity is the consideration of Manning's equation. That equation is the following:

$$Q = \frac{AR^{2/3}S^{1/2}}{n}$$

Where:

- Q = discharge (m<sup>3</sup>/s)
- A = area of flow (m<sup>2</sup>)
- R = hydraulic radius (m)
- S = slope of water surface (m/m)
- n = roughness coefficient

The velocity of flow is  $Q/A$  in metres/s.

As can be seen, an increase in slope, with the other parameters remaining the same, results in an increase in discharge or velocity. Steepness of slope has a direct impact on both stormwater discharge and velocity of flow.

## 6.3 Rainfall

As can be seen from Figure 6-2, rainfall around the country is highly variable and having a sizing criteria based on one area alone will not be suitable for other parts of New Zealand.

There are three possible ways that rainfall can impact on erosion and sediment control practices.

- Storm size,
- Storm intensity, and
- Seasonal variation of rainfall.

Storm size and intensity are the easiest to consider since there is data available either through the latest version of High Intensity Rainfall Design System (HIRDS) as developed by NIWA (Thompson, C., 2002) or through locally developed rainfall information. If local rainfall data is available, use the more stringent rainfall in the sizing calculations.

The rainfall storm frequency of occurrence will be discussed further in the Subsection 6.6 but the issue of storm duration needs to be discussed. For sizing storage devices (ARC and Environment Waikato require ponds to be 2 or 3% of catchment areas), the ARC and Environment Waikato use a 24-hour storm and Environment Canterbury uses a 10-hour storm. Most guidelines specify a volume of storage that is required based on the catchment area draining to the storage device. Normal criteria would be 1%, 2% or 3% of catchment areas assuming one metre in depth of storage. Thus, a 1% pond having a catchment area of 10,000 m<sup>2</sup> would require a practice that can hold 100 m<sup>3</sup> of storage. The actual development of such criteria is not always clear.

Seasonal variation of rainfall, while important in terms of variability and dry periods between storms, is also important to consider and local councils should be consulted to gain a local awareness.

Also, while discussion of global warming is important when considering changes in weather patterns from a long term perspective, it is not considered as an issue related to erosion and sediment control, which are temporary, short term issues that do not need to account for long term warming trends and their impact on storm intensity increases.

**Figure 6-2**  
2-year, 24-hour Rainfall Map

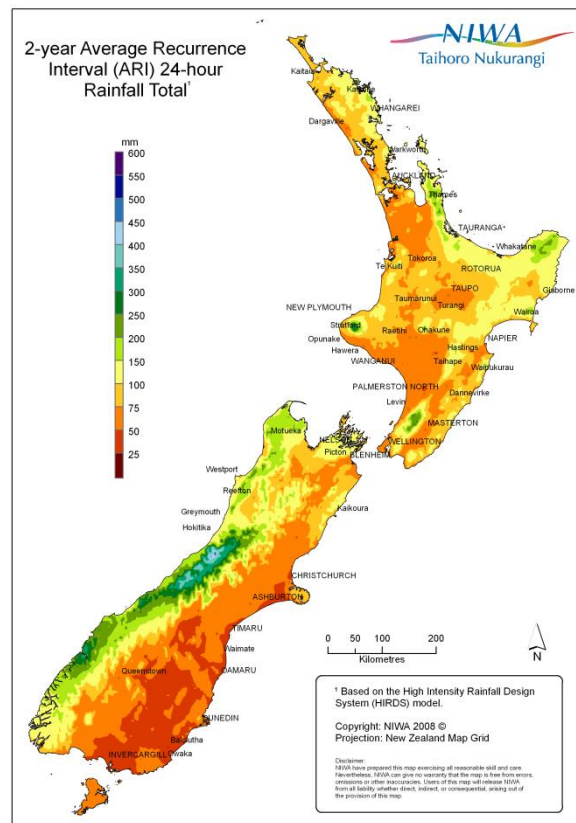

## 6.4 Ground cover

A key principle in erosion and sediment control is to try to only disturb the ground that needs to be disturbed. Bare ground will have a different runoff capability than well vegetated ground. As an example, Table 6-2 provides some Rational Formula (Kuichling, 1889) runoff coefficients (C factors) for calculating runoff from vegetated areas compared to runoff from bare soils.

**Table 6-2 Ground cover and soils versus runoff coefficients for the rational formula**

Ground cover and soils	C factor (runoff coefficient)
Sandy grassed area, average slope (~7%)	0.1 – 0.15
Clay grassed area, average slope (~7%)	0.18-0.22
Clay pasture	0.15-0.45
Bare compacted soil, smooth	0.30-0.60
Bare compacted soil, rough	0.2-0.5

In a similar manner, the Erosion and Sediment Control Guideline for Environment Canterbury (2007) has a Table providing runoff coefficient values for different soil types and slope for bare soil conditions. Table 6-3 provides that information.

**Table 6-3 Representative C (runoff coefficients) values for different soil types and slope (Environment Canterbury, 2007)**

Soil types/slope	C factor
Flat gravel (<5%)	0.15
Sloping gravel (>10%)	0.25
Flat silt loam (<5%)	0.3
Sloping silt loam (10-20%)	0.4
Steep silt loam (>20%)	0.5
Clay (<10%)	0.65
Clay (>10%)	0.75

As can be seen, the runoff from bare soil is greater than the runoff from vegetated sites. This is an important element for two reasons:

- In calculating what the sizing should be for storage devices, and
- Trying not to disturb more land than is necessary for site work to reduce stormwater runoff.

Limiting site disturbance is not generally a practicable option on state highway projects due to limited space within designations but there may be situations where additional area may be left natural and thus reduce runoff volumes and peak rates of discharge.

## 6.5 Risk

In determining the level of control that is necessary for protection of downstream resources, it is important to understand the risk associated with site activities and that risk relates to the sensitivity of the receiving system. In Section 3, Table 3-1 provided a prioritisation of the sensitivity of receiving systems

The level of risk to these receiving environments needs to be considered in the design of erosion and sediment control practices. Figure 6-3 provides a representation of risk related to project duration. As can be seen the determination of storm event sizing related to risk depends to a large extent on the duration of construction and the potential for a given storm to occur. Figure 6-3 is not to be used for design but rather provides the basis for the criteria established in Table 6-4.

In terms of risk, Table 3-1 prioritises receiving environments and provides a basis for establishment of criteria for sizing storage practices. Using the sensitivities of receiving environments can form the basis for providing risk based criteria. Determination of risk can be somewhat subjective but use of the Australia New Zealand Environment and Conservation Council Guidelines (ANZECC, 2000) can provide the basis for criteria. They establish guidelines for four

different levels of protection for different aquatic ecosystems of 99%, 95%, 90% and 80% protection. If these are used in conjunction with the risk of different storm events occurring during the project as shown in Figure 6-3, criteria can be developed that establishes sizing for erosion and sediment control practices as shown in Table 6-4.

**Figure 6-3**  
Probability, Expressed as a Percent, of a Design Storm not Being Exceeded During a Project Life

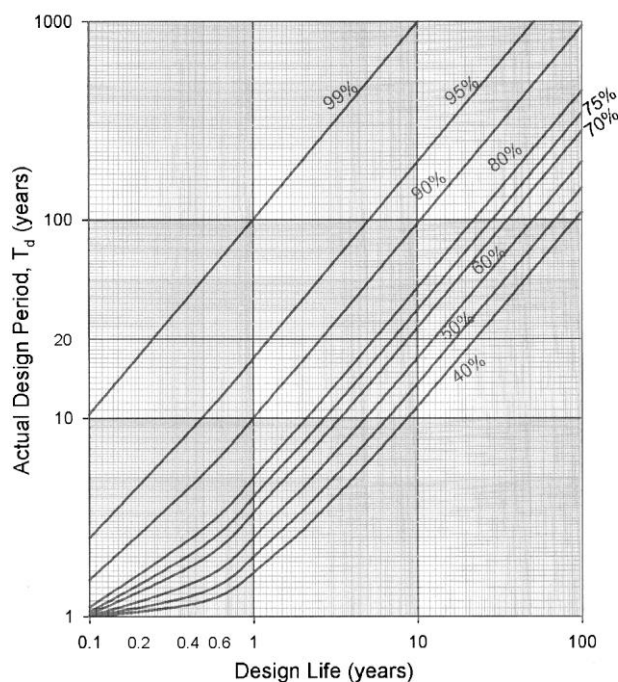

**Table 6-4 Receiving environments and sedimentation issues**

Receiving system	Water quality	Design risk (%)	Storm to design for	
			Site disturbance less than 6 months	Site disturbance greater than 6 months
Estuaries	Highest potential effect	99	20-year storm	100-year storm
Streams, Rivers and wetlands	High potential effect	95	10-year storm	20-year storm
Ground (karst geology)	High potential effect	95	10-year storm	20-year storm
Lakes	Moderate potential effect	90	5 year storm	10-year storm
Harbours	Lower potential effect	80	2-year storm	5-year storm
Open coast	Lower potential effect	75	2-year storm	5-year storm

If the HIRDS data is used for rainfall determination, the 5-year storm is not provided in that data output. Where storage practices are designed for the 5-year storm, interpolate between the 2- and 10-year rainfalls by using the half-way point between them. That won't be the exact value of the 5-year storm but it will be the approximate value within several millimetres of the actual 5-year storm.

## 6.6 Criteria for risk reduction

Table 6-4 provides criteria for what frequency storm design for when designing storage practices. One other criterion must be specified in order to size erosion and sediment control practices and that is storm duration. Section 2.2 had a discussion of the USLE and one element in that equation is a rainfall and runoff factor (R). That rainfall and runoff factor is directly proportional to the total storm energy and the storm intensity (Wischmeier, Smith, 1978). For purposes of this standard the USLE is not being used for design purposes but rather to detail those factors that designs must take into consideration.

This Standard recommends that storage sizing be based on a 1-hour rainfall for the storm for design. The 1-hour storm was also chosen as providing reasonable sizing requirements if the duration of the storm is provided in seconds. Longer times provide significantly larger volumes and the storage requirements become unreasonable.

## 6.7 Sizing for storage practices

Using the storm recurrence intervals in Table 6-4, the volumes of storage can be calculated by using the rational formula and calculating a volume by using a trapezoidal hydrograph approach.

$$Q = .00278CiA$$

Where:

- Q = Peak discharge (m<sup>3</sup>/s)
- C = Runoff coefficient (unit less)
- i = Rainfall (mm)
- A = catchment area (ha)

With C determined by Table 6-3 and i determined using HIRDS rainfall data or local data, where appropriate.

Once Q is calculated:

$$V = QD$$

Where:

- V = Volume of storage practice (m<sup>3</sup>)
- Q = Peak discharge (m<sup>3</sup>/s)
- D = Storm duration (sec.)

With D = 3600 seconds for a 1-hour storm.

The volume calculated is then used to size the storage practice.

## 6.7.1 Example calculations

$$Q = .00278CiA$$

**Table 6.5 Representative C values for different soil types and slope (Environment Canterbury, 2007)**

Soil types/slope	C factor
Flat gravel (<5%)	0.15
Sloping gravel (>10%)	0.25
Flat silt loam (<5%)	0.3
Sloping silt loam (10-20%)	0.4
Steep silt loam (>20%)	0.5
Clay (<10%)	0.65
Clay (>10%)	0.75

### Steps

1. Determine site location and from that determine latitude and longitude
2. Determine project duration.
3. Using HIRDS or local data select the 1-hour storm using the appropriate frequency storm event risk factor for the receiving environments. (2-year, 5-year, 10-year, 20-year or 100-year from Table 6-4)
4. Determine site soils and slope to select the C Factor.
5. Determine the site area that would drain to a storage practice
6. Use the Rational Formula to calculate the peak discharge for the storm selected in step 1.
7. Multiply the peak discharge by 3,600 seconds to get the volume of the sediment storage practice.

### Orewa

1. Drains to Nukumea stream so design risk factor is 95%, use a 20-year storm. Site latitude is 36° 34', site longitude is 174° 40'
2. Project duration > 1 year.
3. Rainfall is 41.5 mm
4. Site soils are clay with slopes greater than 10% so C = 0.75
5. Site area is 1 ha for simplisiticity
6.  $Q = .00278(41.5)(.75)(1) = 0.0865 \text{ m/s}$
7. Storage volume =  $0.0865(3600) = 311.49 \text{ m}^3$

### Whangarei

1. Drains to Whangarei Harbour so design risk factor is 80%, use a 5-year storm. Site latitude is 35° 43', site longitude is 174° 19'
2. Project duration > 1 year.
3. Rainfall is 33.45 mm
4. Site soils are clay with slopes less than 10% so C = 0.65
5. Site area is 1 ha for simplisiticity
6.  $Q = .00278(33.65)(.65)(1) = 0.06 \text{ m/s}$
7. Storage volume =  $0.06(3600) = 216 \text{ m}^3$

### Taupo

1. Drains to Taupo Lake so design risk factor is 90%, use a 10-year storm. Site latitude is 38° 41', site longitude is 176° 04'
2. Project duration > 1 year.
3. Rainfall is 29.1 mm
4. Site soils are gravel with slopes steeper than 10% so C = 0.25
5. Site area is 1 ha for simplisiticity

6.  $Q = .00278(29.1)(.25)(1) = 0.02 \text{ m/s}$
7. Storage volume =  $0.02(3600) = 72 \text{ m}^3$

#### Christchurch

1. Drains to Estuary so design risk factor is 99%, use a 100-year storm. Site latitude is  $43^\circ 32'$ , site longitude is  $172^\circ 40'$
2. Project duration > 1 year
3. Rainfall is 29.2 mm
4. Site soils are gravel with slopes less than 10% so  $C = 0.15$
5. Site area is 1 ha for simplicity
6.  $Q = .00278(29.2)(.15)(1) = 0.012 \text{ m/s}$
7. Storage volume =  $0.012(3600) = 43.2 \text{ m}^3$

In the case of Christchurch, Environment Canterbury uses a greater rainfall than is provided by HIRDS. In this situation local rainfall data must be used due to its improved accuracy.



## 7. Project requirements

Section 7 provides background to the role that local authorities play in the setting of objectives and processes in achieving water quality outcomes. An overview of the two dominant approaches to achieving water quality outcomes is firstly discussed and a set of draft model consent conditions are provided, followed by a discussion on other non-structural practices (earthworks season and construction staging) used by local authorities.

### 7.1 Specific consenting requirements

As outlined in Section 1.1.1, soil and water is managed by regional councils who are responsible for the quality and quantity of the water in water bodies within their boundaries. (For the purposes of this discussion, the use of the term regional councils also includes unitary authorities). They manage water allocation quantity and quality issues by means of regional policy statements and regional plans and through the resource consent process. The regional plans will state whether the use of particular practices, a requirement to adopt the BPO or a requirement to meet a certain water quality standard (imposed either under conditions of a resource consent or as a requirement for a discharge to occur as a permitted activity) must be complied with for site development. A particular plan or consent could use a combination of these approaches.

As a general comment, regional plans will predominately focus on managing the effects of activities upon water quality and quantity as well as soil conservation. On the other hand, territorial authorities have a different emphasis in their district plans and are responsible for the control of any actual or potential effects of the use, development or protection of land. Accordingly, applications to territorial authorities for resource consents for land use activities and notices of requirement for designations will require consideration of the effects of the proposed activities upon amenity, traffic movements and character amongst other considerations rather than the focus on water quality that regional plans have. The various functions of the two types of local authority under the RMA are set out in sections 30 and 31 of the RMA.

The activities involved in state highway projects will typically require authorisations to be obtained from both types of local authorities as the scope of the project will typically exceed the permitted activity thresholds in both the district and regional plans. The threshold for requiring a consent and the activity status of any consent is governed through the regional and district plan prepared by regional councils and territorial authorities respectively.

In general terms, the following factors will determine whether or not resource consent is required for earthworks and streamworks:

- Whether or not the Agency will be working in, or close to, an identified riparian protection zone (sediment control protection area),
- Time of year,
- Extent of disturbance (including any vegetation removal or modification),
- Area and volume of earthworks,
- Slope of area being earthworked,
- Type of soil being worked,
- Duration of earthworks, and
- Length, diameter and type of structure within a waterbody including the area/length of disturbance of the bed and banks of the waterbody.

To determine the requirements for consent for your project, it is essential that you have discussions with the regional council and territorial authority in the first instance.

Councils have a number of statutory and non-statutory tools at their disposal to ensure that water quality objectives are met. These include:

- The imposition through regional plans and/or resource consent conditions of requirement to use particular practices, adopt the BPO or meet a certain water quality standard.
- The development of guidelines to assist practitioners with the design, construction and maintenance of erosion and sediment control practices;
- The adoption of an earthworking season. and
- The imposition of a requirement for the staging of works and thereby limiting the area of open ground and the duration of the works.

These aspects are discussed below.

### **7.1.1 Water quality discharge standards and BPO approach**

Standards to manage the quality of diffuse and point-source water discharges can be implemented in several ways.

Output-based standards can be applied as an absolute measure using a threshold level typically measured by turbidity or TSS to limit sediment load. Alternatively, practice-based standards approach can be utilised to require the use of particular practices known to influence sediment loading. For example, sediment loading can be controlled by establishing allowable levels of earthworking or the requirement to install specific technology. Another option is a general requirement for the resource user to adopt the BPO to manage the effects of discharges.

There are other methods to achieve water quality outcomes utilising economic instruments although these fall outside the scope of this Standard.

The above three approaches are given statutory force primarily within regional planning instruments (regional policy statements and regional plans) but also within district plans.

The different approaches mentioned above are provided for in the RMA;

- Enabling regional plans to contain rules requiring the observance of standards for the maintenance of water quality (section 69 of the RMA),
- Enabling resource consents to be made subject to conditions requiring particular works to be undertaken (s108(2)(c) RMA),
- Requiring the resource user to adopt the BPO to address adverse effects of discharges (sections 70 and 108(2)(e) of the RMA), and
- Enabling resource consents to be made subject to conditions requiring work to be done in stages (s107(3) RMA).

A clear distinction between the approaches needs to be made. A discharge standard will enable the discharge of sediment into receiving waters up to a maximum threshold set by the consenting authority (*e.g.* no more than 100g/m<sup>3</sup> of TSS after reasonable mixing).

A practices based approach will typically use a set of best management practices (*viz* erosion and sediment controls) to achieve the minimisation of sediment yields. The design of these measures are such that they will not remove all of the incoming sediment load but operate at an efficiency as discussed in Section 4 previously.

It is important to note that where a water quality standard is used, there may be significant variation between the type and quantum of parameters that are used between the regional councils. In addition, a number of regional councils do not use water standards and rely on a practices based approach only. This is an important consideration when designing an ESCP.

#### **7.2.1.1 Context of water quality standard**

Establishing water quality standards is becoming more recognised as the better quantified approach to providing for downstream aquatic resource protection. A detailed and comprehensive approach to this is the use of the Australian and New Zealand Guidelines for

Freshwater and Marine Water Quality (ANZECC guidelines). ANZECC Guidelines have trigger values that are used for toxicants and a sliding scale trigger value is provided at the 99% (highest value of protection), 95% (slightly too moderately disturbed), 90% or 80% (generally as intermediate targets for improvement of degraded systems). However, the ANZECC Guidelines do not provide a standard for TSS and state that ranges for turbidity and particulate matter are similar and they only include turbidity standards.

Table 7-1 details the information from Table 3.3.11 of the ANZECC Guideline regarding trigger values for water clarity (lower limit) and turbidity (upper limit) indicative of unmodified or slightly disturbed ecosystems in New Zealand.

**Table 7-1 Default trigger values for water clarity**

Ecosystem types	Clarity (m-1)	Turbidity (NTU)
Upland Rivers	0.6	4.1
Lowland Rivers	0.8	5.6

In contrast, sediment-laden runoff from earthworks may produce values in the order of 100's to 10,000's NTU into the receiving environments.

An advantage to using turbidity as a measure of performance is that it can be taken and analysed on site with instantaneous results obtained. If a consent requirement is to monitor TSS then samples have to be taken and transported to a laboratory for analysis. Results for a given storm may not be available for several days.

Since values for turbidity and TSS are not equivalent or consistent from site to site, a relationship can be calibrated on a site-by-site basis and, with concurrence from the consenting authority, turbidity may be used as a surrogate for TSS.

Another approach is the use of biological assessments which is given considerable discussion in the ANZECC Guidelines. It can be used in determining aquatic system health and to assess the impacts related to a given consent.

The linking of chemical and biological monitoring to define the cause and effect scenario is being utilised more frequently and is often required under conditions of consent. These may be established on a catchment scale (e.g. monitoring of Lake Taupo, Rotorua Lakes) or at the project level (e.g. ALPURT B2) to determine the effects of development on a specific receiving environment.

#### **7.2.1.2 Practice based approach**

Instead of specific water quality targets, a number of regional councils use a practice based approach as the basis for resource consents.

This approach may rely on technical guidance, that when complied with, is likely to achieve a desired outcome. It recognises the variability of monitoring data and quality control issues that often accompany monitoring. The basic premise is that design and operation in accordance with local guidelines provides the basis for determining compliance with consent conditions.

## 7.1.2 Draft model resource consent conditions

The majority of Transport Agency capital works projects will require either an earthworks consent and/or a stormwater discharge consent. The nature of erosion and sediment control is that it is managed through the implementation of an ESCP that is developed as outlined in Section 5.5 of this guideline.

When lodging an application for resource consent, in regards to erosion and sediment control, the Transport Agency has developed the following three draft model conditions.

**Table 7 -2 Draft model resource consent condition for state highway infrastructure**

1	During construction the consent holder shall take all practicable measures to minimise erosion and prevent the discharge of sediment beyond the boundaries of the site.
2	Erosion and sediment control measures shall be implemented throughout construction of the Project and shall be constructed and maintained so as to operate and perform in accordance with the Erosion and Sediment Control Guidelines for State Highway Infrastructure.
3	An Erosion and Sediment Control Plan shall be prepared in accordance with the Erosion and Sediment Control Guidelines for State Highway Infrastructure, and shall be submitted to [consenting authority representative] prior to construction for certification. If the Consent Holder has not received a response from [consenting authority representative] within 20 working days of submitting the Construction Erosion and Sediment Control Plan, the Consent Holder will deem to have an approval and can commence earthworks.

## 7.1.3 Regional erosion and sediment control guidelines

To facilitate the achievement of water quality objectives, many regional councils have developed technical guidelines (*e.g. Environmental Guideline 2010/01 – Erosion and Sediment Control Guidelines for Land Disturbing Activities by Environment Bay of Plenty*) demonstrating how the various measures can be designed, constructed and maintained. It is important to note that these are guidelines and therefore do not have the statutory weight of a regional or district plan although the requirement to construct practices in accordance with the guideline is often a condition of consent.

It must be noted that particular resource consents may require compliance with local erosion and sediment control guidelines. There is the potential that local guideline requirements may exceed the requirements of this Standard and the designer must be aware of the local guidelines and meet the more stringent criteria whether it is this Standard or the local criteria.

These guidelines can be found on the relevant regional council websites.

## 7.1.3 Construction staging

Construction scheduling involves the coordination of three construction-planning activities: Site staging, limiting site disturbance, and construction sequencing.

- Site staging reduces erosion from a site by reducing the amount of soil exposed at any one time by staging. construction activities,
- Limiting site disturbance preserves areas that are highly susceptible to erosion and maintains them as vegetated areas, and
- Construction sequencing involves planning land disturbance activities to coincide with the installation of management practices.

These tools; when combined, reduce land disturbance, protect highly erodible areas, provide for timely installation of necessary erosion control practices, and promptly restore protective cover after disturbance. The result is that the disturbed soil is exposed for a shorter period of time, significantly reducing soil loss.

**Embankments have been progressively stabilised so that the works can be staged**



### Site staging

Site staging involves planning construction activities so that land disturbance is performed in stages. Rather than disturbing an entire site, only those areas under active construction are disturbed. Subsequent areas are then cleared as the construction process progresses, while previously disturbed areas are stabilised with surface protection techniques (e.g. mulch, hard fill etc.). The soil surface is left exposed and unprotected for shorter periods of time, resulting in a significant reduction in soil loss. Therefore, fewer erosion control practices are required at any one time, which may also reduce maintenance requirements and costs.

This aspect may take the form of resource consent conditions which require the consent holder to limit the maximum area of exposed ground being earthworked.

### Limiting site disturbance

Limiting site disturbance is a planning tool that can significantly reduce soil loss from a site. Early in the planning process, highly erodible areas, such as steep slopes and unstable soils, can be identified. Those areas can be designated as areas to remain undisturbed and be protected during construction to prevent soil loss. Undisturbed areas may also act as buffers, reducing runoff velocities and reducing soil loss when compared to disturbed conditions.

It is recognised that limiting site disturbance on state highway projects may not be achievable; for example due to confined designation boundaries or site topography although it is a good practice to consider when doing earthworks on any project. There may be opportunities to limit site disturbance that have not previously been considered.

### Construction sequencing

Construction sequencing requires consideration of all facets of site preparation and construction, including sensitive areas of the site, before any work is performed. A construction sequencing plan is created by compiling a list of the practices to be installed and a list of construction activities to be performed. The two lists are then combined to determine what practices must be in place before other activities begin. The result is that all erosion and sediment control practices are in place and functional before the relevant land disturbance activity begins, reducing the potential sediment yield from the site.

Similar to the limitation on staging areas via consent conditions, sequencing of the works may be enforced (e.g. winter shutdown) through conditions imposed during the statutory resource consent process.

### 7.1.4 Winter construction and shutdown period

In a number of regions throughout New Zealand, a winter shutdown period is used as a non-structural practice to limit earthworking activities. The winter shutdown is effectively a risk management tool which recognises that climatic conditions are generally not favourable to earthworking during the wetter winter months. For example, a study of rainfall, runoff and dry periods in the Tauranga area concluded that there were only half the drying days on average in winter, compared with summer (Babington and Associates Ltd, 2001).

The potential problems of earthworking during this period may include:

- Difficulty of machinery access onto the site,
- Difficulty of stabilising exposed ground either by access or germination conditions,
- Colder soil temperatures and less sunshine hours required for grass germination,
- Unsuitability of some soils to be worked in wet conditions (*e.g.* to ensure optimum moisture content required for geotechnical strength),
- Increased risk of sediment-laden discharge, and
- Larger flows and velocities (when working in and near watercourses).

The potential problems noted above are aggravated with soils containing higher fractions of silt and/or clay or where seasonal high water tables are encountered.

Typically, the winter closedown period may extend from the end of April to the end of September although this will vary between regions. These periods, albeit with variability between regions, represent the “trade-off” between falling soil temperatures required for successful seed germination versus the increased risk of excessive discharges with increased rainfall. However, it is noted that there may be a seasonal lag and in a number of instances, earthworking beyond this period may continue subject to approval from the appropriate local authority.

Some local authorities have adopted the earthworking season as a “formal” policy (*e.g.* Bay of Plenty Regional Council) through Council Resolutions whilst others may make the winter exclusion period a condition of particular resource consents (*e.g.* Auckland Council). In a similar manner, requirements for the adoption of a BPO approach are used by some regional councils during winter earthworking whilst others will require strict adherence to a discharge standard during this period. It is therefore imperative that you check with the appropriate local authority and check any relevant resource consents to determine obligations during the winter season.

**Mulching being applied in preparation for winter shutdown of the site**



As a “rule of thumb” the circumstances when winter works are likely to be allowed include those listed below:

- The site is located on sandy soils with good ground infiltration and the terrain is not too steep. (It may be preferable that earthworks be undertaken in the winter shutdown period in these locations, as this lowers the risk of dust during the drier summer months), and/or
- The works have already commenced and there is a higher risk to the environment if they were to cease before completion, and/or

- When there is no discharge off site, and/or
- If a discharge is proposed, that discharge is required to meet a quality limit that is matched to the receiving environment and any sensitivities of this receiving environment as identified under an Assessment of Environmental Effects, and/or
- If a discharge is proposed, an appropriate monitoring regime is in place to confirm that the water quality standards on any discharge have been complied with, and/or
- If earthworks are to excavate and backfill trenching for the installation of services, including stormwater infrastructure and telecommunication or other cabling, and/or
- If earthworks are to maintain and/or construct new erosion and sediment controls, and/or
- If confirmation is provided that provision for rapid stabilisation methods is available and that there is sufficient capacity for contractors to meet the demand during this period.

The approval for winterworks extensions are normally assessed on a project and yearly basis.

### 7.3 NZTA minimum requirements

In recognition of the differing technologies and the various climatic, geomorphic and soil considerations within each region, there are a range of erosion/sediment control guidelines developed by local authorities throughout New Zealand. When overprinted with the different thresholds of water quality standards, potentially a number of differing water quality outcomes may arise. The challenge therefore, in the setting of a national-based standard is to:

- Firstly, reconcile these outcomes to ensure that a standard approach is achieved which takes into account the different environmental considerations and receiving environments, and
- Secondly to ensure that the Standard does not conflict with the water quality outcome requirements for the various regions.

Section 6 outlined a risk-based approach which matches the sizing criteria required for the erosion and sediment controls to the sensitivity of the receiving environment. In order to achieve these outcomes, section 8 and 9 will prescribe a range of erosion and sediment control practices utilising a best practice based approach and the specifications of these practices. These practices are tailored to exceed in many instances, the performance efficiencies outlined in the regional guidelines. On a number of occasions (particularly during winter), the installation of these practices may not meet the relevant regional water quality standards and this aspect would need to be confirmed with the regional council during the resource consent process.

For Transport Agency projects and emergency works, it is recommended that all earthworks activities should implement erosion and sediment control practices to reduce downstream effects at the appropriate scale to manage the magnitude of effects.

## 8. Erosion control practices

This section focuses on erosion control and provides the structural measures to the concepts outlined in Section 4 of the Standard. Within this section, the control of erosion from an earthworks site has been considered from two aspects:

1. Controlling the volume and rate of water runoff from within and external to your site,
2. Providing a protective cover against soil transportation using stabilisation methods.

In any earthworks site, both of these types of practices will be required. However, the choice of which erosion control measure to be used will depend on the specific site constraints and the project construction sequencing. It is rare for only one practice to be used rather it is more likely that they be used in conjunction with each other.

Control of site runoff through water management controls is one of the most important erosion control measures that can be done in your works area. These practices help to reduce water velocities and provide some reduction in contributing catchments requiring treatment with the overall aim of minimising sediment generation.

The common water management controls on earthwork sites are,

- check dams (section 8.1),
- contour drains (section 8.2),
- diversion channels and bunds (section 8.3),
- pipe drop structure and flume (section 8.4),
- stabilised entranceways (section 8.5),
- surface roughening (section 8.6), and
- benched slopes (section 8.7).

A stabilised site is one that is resistant to erosion. Stabilisation is defined as applying measures such as vegetative or structural practices that will protect exposed soil and prevent erosion. Common stabilisation measures include spreading of aggregate, grassing (either with grass seed or hydroseed), applying mulch/compost and the use of geotextiles.

The stabilisation techniques can be used as either a temporary or permanent measure against erosion. In some instances, an instant protection (e.g. geotextiles) can be obtained; whilst at times (e.g. grassing) may be required before the area is appropriately protected against erosion.

In relation to geotextiles, there are many and varied types and products. These range from those that physically shed water through to those that incorporate seed and mulch and so encourage vegetative growth, while protecting the bare soil against erosion.

Where vegetation is used, during the earthworking portion of site works the surface is considered stabilised once an 80% vegetative cover has been established over the entire exposed area of earthworked areas. Because vegetation is so effective in reducing runoff, it can minimise the erosion potential of a construction site and reduce the need for structural practices. It is therefore important to preserve as much of the existing vegetation as possible by limiting the extent of works.

Further detail is provided below on the common measures used for stabilisation purposes. They comprise of;

- topsoiling and grass seeding (section 8.8),
- hydroseeding (section 8.9),
- mulching (section 8.10),
- turfing (section 8.11),
- geotextiles, plastic covers, erosion control blankets and geo binders (section 8.12),
- dust control Section 8.13).



## 8.1 Check dams

### 8.1.1 Definition and purpose

Check dams are small dams made of rock rip-rap, filter socks or other non-erodible material constructed across a swale or channel to act as grade control structures.

The purpose of a check dam is to:

- Reduce the velocity of concentrated flows, and
- Be placed in series down the channel and used during construction to reduce invert scour in drains or channels that will be reworked, filled, grassed or otherwise stabilised.

Check dams are not intended to be a sediment trapping practice and the dams work by temporarily ponding the water and then naturally releasing the impounded water at a more controlled rate.

**Check Dam**



### 8.1.2 Conditions where practice applies

Check dams may be:

- Placed within temporary swales or channels, which because of their temporary nature may not be suitable for a non-erodible lining (e.g. geotextile) but still need some protection to reduce erosion.
- Placed in either temporary or permanent swales/channels which need protection during the establishment of vegetative cover.

### 8.1.3 Limitations

Check dams have the following limitations:

- The contributing catchments for a complete series of check dams should not exceed 1ha for slopes less than 10%. With contributing catchments greater than this area, specific engineering design using the methodology in Section 6 should be done.
- They may not be an effective practice on steep slopes as they will need to be very closely spaced to achieve design criteria.
- They are not recommended for use in watercourses with perennial flow.
- They are water control measures only - not intended for sediment trapping purposes.
- Channels will erode if the dams are spaced too far apart (especially on highly erodible soils).

**Filter sock check dams**  
(image provided by Erosion Control Co. Ltd.)



- Check dams can be time consuming to construct, especially on steep slopes where a greater frequency of dams per unit length is required.
- They may not be a suitable option to provide erosion protection when highly erodible soils, susceptible to tunnel erosion are prevalent.

### 8.1.4 Key design criteria

Temporary check dams are typically constructed of loose rock (rip-rap) or sandbags. Prefabricated and re-useable triangular plastic material is also available, and reinforced fabric dams can also be used. However, it is critical that they are constructed of competent material and do not erode themselves.

The check dams can either be constructed with a 450mm centre height or a 600mm centre height and the following table is to be used to determine the spacing of check dams for channel slopes within indicated ranges. Spacing for check dams are outlined in Table 8-1.

**Table 8-1 Positioning of check dams**

Slope of site (%)	Spacing (m) between dams with a 450mm centre height	Spacing (m) between dams with a 600mm centre height
Less than 2%	24	30
2 - 4%	12	15
4 - 7%	8	11
7 - 10%	5	6
>10%	Unsuitable - use stabilised channel or specific engineered design	Unsuitable - use stabilised channel or specific engineered design

**Check dam installed in highly erodible soils. Problems with excessive spacing, unsuitable location and insufficient upturn resulting in water outflanking the structure (Photo – Environment Canterbury).**

- The maximum height of a check dam depends on the depth of the drain into which it is being placed. As a general rule the centre height (spillway level) should be no higher than 600mm.
- All check dams must incorporate a spillway to direct flows over the centre of the structure with the spillway elevation at least 150mm to 200mm lower than the crest of the structure.
- To be effective, place check dams so that the toe of the upstream dam is at the same elevation as the crest of the downstream dam. The standard detail of check dams is shown in Figure 8-1.
- When used on highly erodible soils, check dams should be placed on a needle-punched geotextile fabric to minimise the chance of water undermining the structure.
- When filter socks are used as check dams, they must be pegged in place to ensure that they are secure.



## 8.1.5 Filter sock construction specifications

- Filter socks can either be filled on site or prefabricated in suitable lengths prior to delivery.
- The filter sock shall be produced from HDPE or polyester material with abrasion resistant netting weaves (a thread diameter of not less than 0.3 mm). The recommended weave for compost sock is an opening in the knitted mesh of 1-5 mm when filled and for straw socks no more than 20 mm openings.
- The sock shall then be filled with compacted filter material meeting the following:
  - Sawdust specification is for no treated wood sawdust and free from contaminants.
  - Straw specification is that the straw be free from weed seeds and free from contaminants.
  - General specification is that filter medium shall be clean and free from contamination.

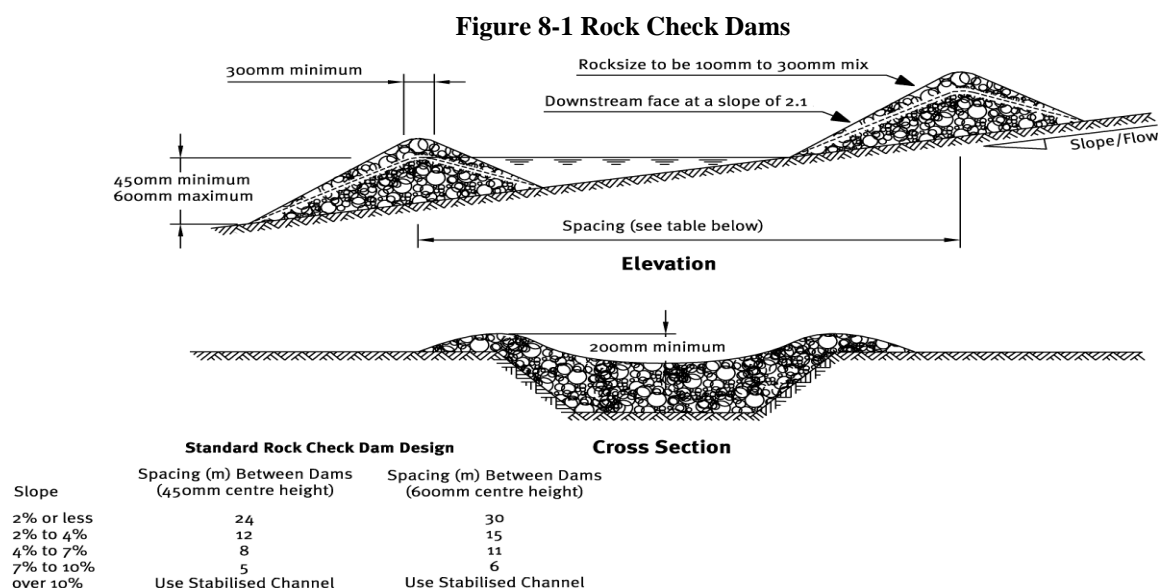

## 8.1.6 Maintenance

Key items to check as part of the regular inspection includes:

- Repair or reinstate the check dams if destroyed by machinery movement.
- Inspect the check dams after rainfall or storms and repair as necessary.
- Check if water is outflanking the structure and look for scouring around the edges of the check dam: if so – increase the spillway depth, crest height and/or turn up edges of structure.
- If scour is occurring between check dams then additional structures may need to be provided.
- Check dams should be inspected for sediment accumulation after each significant rain event. Sediment should be removed when it reaches 40% of the original height or before this occurs.
- For filter socks, excessive ponding behind the filter sock indicates that the filter media has become clogged and its effectiveness as an erosion control device may be reduced. The filter sock shall either be replaced or another filter sock placed on top of the existing filter sock to ensure adequate drainage.
- Dispose of removed sediment to a secure area to ensure that it does not discharge to the receiving environment.

### **8.1.7 Decommissioning**

In decommissioning check dams consider the following:

- Remove check dams when no longer needed, and where possible salvage all materials for re-use in future check dams or other works.
- Do not remove check dams that are protecting grass-lined channels until a complete and sustainable cover has been achieved.
- Areas disturbed by the removal process must be seeded, fertilised and protected with surface mulch or erosion-control matting if required.

## 8.2 Contour Drains (Cut-offs)

### 8.2.1 Definition and purpose

Contour drains are temporary excavated channels or ridges or a combination of both, which are constructed slightly off the slope contour.

The purpose of a contour drain is to:

- Break overland flow draining down disturbed slopes by reducing slope length and thus the erosive power of runoff, and to divert sediment laden water to appropriate controls via stable outlets.
- Use as mid-slope contour banks and/or drains are short-term, temporary structures placed across unprotected slopes within the working area at the end of each day's work, before site closedown or when rain is imminent.

Contour drain. (Source: Environment Canterbury)



### 8.2.2 Conditions where practice applies

The practice of using contour drains should be promoted on all earthworks sites, especially where there are large areas of exposed ground and long steep slopes. The specific scenarios for their application include the following:

- To reduce the overall contributing catchment and to segment slopes so that the water flows on these slopes are reduced, limiting the erosion potential of the water. They should be used at mid to lower slopes on all exposed areas.
- To assist with the diversion of dirty water flows towards sediment retention devices (e.g. sediment retention pond, decanting earth bund). Note that they do not form the same function as a Dirty Water Diversion Bund as they are more of a temporary feature.
- To use as cut-offs on tracking activities to direct water into a stable watertable and/or outfall structure.

### 8.2.3 Limitations

Contour drains have the following limitations:

- Contour drains will concentrate sheet flows, thereby increasing erosion potential. This is of most concern on any steep slope and in any vulnerable soils such as uncompacted fills and weak soils.
- They may not be an effective practice on very steep slopes (>30%) as they will need to be very closely spaced to achieve performance characteristics.
- Unless the right sizing and spacing of drains is utilised, they have the potential to overtop during high intensity rainfall events.

- Steep contour drain longitudinal grades (> 2%) will increase flow velocities and may promote erosion. In these circumstances drains will need to be lined to prevent scouring within the channel invert.
- Excessively flat contour drain grades mean sediment deposition is likely to occur, reducing capacity and potentially resulting in overtopping of the structure.
- Due to their temporary nature, they may be a “weak link” in the overall treatment train by being installed too late or not sized/spaced appropriately.

### 8.2.4 Key design criteria

Formal design of the contour drains is generally not required due to their temporary nature. Although commonly called contour drains, this term is misleading as they need to be constructed slightly off the contour to ensure they drain appropriately.

The following design principles are critical to their effectiveness as an erosion control practice with these aspects outlined in Figure 8-2:

- Minimum compacted bank height of 250mm.
- Minimum depth of 500mm.
- Longitudinal gradients not to exceed 2% (otherwise lining may be required).
- Be broad enough to create a low-profile bank so that large earthworking machinery can safely cross. If this is not achievable, a dedicated crossing using a temporary culvert can be used.
- Avoid construction with a “V” profile instead use a parabolic (“flat U”) or a square shape.
- Outlets may need to be lined with geotextile or other suitable material.
- No individual drain should have more than 0.5ha draining into it.

**Contour drains established on embankment as a water control measure in conjunction with progressive stabilisation. Note novacoils directing flow down to lower stabilised slope.**



Indicative maximum catchment slope lengths are provided in Table 8-2 below.

**Table 8-2 Contour drain spacing**

Slope of site (%)	Spacing (m) of contour drains
Less than 5%	50
5 - 10%	40
10 - 15%	30
15 - 30%	20

Specifications for contour drains are outlined in Figure 8-2.

**Figure 8-2.  
Contour Drains**

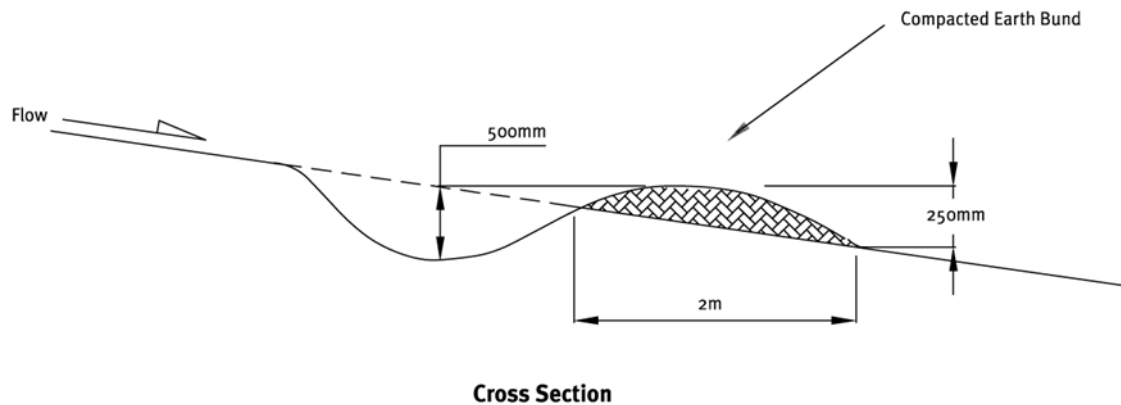

### 8.2.5 Maintenance

Key items to check as part of the regular inspection includes:

- Repair or reinstate contour drains if destroyed by machinery movement.
- Inspect contour drains after rainfall or storms and repair as necessary.
- Check the outfall for erosion and repair if required. It may be necessary to install a temporary flume or provide geotextile.
- Use sandbags during rainfall events if extra height is needed on the ridges of contour drains.

### 8.2.6 Decommissioning

In decommissioning contour drains the banded area should be spread out and stabilised.

## 8.3 Diversion channels and bunds

### 8.3.1 Definition and purpose

Diversion channels and bunds can be non-erodible channels and/or bunds for the conveyance of runoff (either clean or dirty water) which are constructed for a specific design storm.

The purpose of diversion channel and bunds is:

- Primarily to intercept and convey runoff to stable outlets ideally at non-erosive velocities.

- As either cleanwater runoff diversions which intercept “clean” (i.e. no sediment) water away from the works area or dirty water runoff diversions which convey sediment-laden water within the disturbed area and direct it to sediment retention facilities for treatment.

- For clean water diversions, to minimise the potential for erosion damage by reducing the volume of water flowing over the site and hence reduce the potential for sediment generation. They have a “flow-on effect” in that they can reduce the size of a sediment control device as well as the time and cost needed to repair, maintain and/or rework the site and any associated drainage infrastructure.
- For dirty water runoff diversions, to divert sediment-laden water to an appropriate sediment retention structure. Such channels typically located within the disturbed area.

**Cleanwater diversion used to isolate upper cleanwater flows from the works area.**



Both types of diversions can be used as a temporary and permanent measure. However, permanent measures will require channel invert and bank stabilisation measures be installed.

### 8.3.2 Conditions where practice applies

Runoff diversion channels and bunds are predominately used in the following situations:

- To divert clean runoff water above the works site, and divert to stable outlet(s).
- As a physical “perimeter boundary” of an earthworks activity site to isolate the site and prevent sediment from leaving the area.
- To divert sediment-laden water to an appropriate sediment retention device (e.g. sediment retention pond or decanting earth bund).



### 8.3.3 Limitations

Cleanwater and dirty water diversions have the following limitations:

- In contributing catchments greater than 2ha, specific engineering design (sizing, shape and outfall) will be required based on the risk profile outlined in Section 6.
- The longitudinal gradient is to be less than 2% otherwise channel lining may be required depending on the velocities exceeding Table 8-3.
- They should not be confused with contour drains and therefore need to be sized and constructed for the site conditions.
- In some examples (e.g. steep slopes and/or unstable ground), specific geotechnical design will be required to avoid failure of the structure.
- It is often difficult to construct a bund or channel with the required channel capacity on steep slopes. Consider all options and in particular the location of the sediment retention device to which the dirty water diversion will flow into.
- Access for maintenance can be difficult once construction has commenced.

### 8.3.4 Key design criteria

Runoff diversions are essentially channels which are typically constructed across a slope. This requires a bund on the downslope side to prevent flow from spilling out of the channel. Runoff diversions may take the form of catch drains (usually lined with an erosion-resistant material such as needle-punched fabric), existing or new stormwater reticulation systems, combination bank or bund with excavated upslope channel, or earthen bank (often made from compacted topsoil).

There are many designs for runoff diversions; however the following key aspects are required:

- **Location:** Diversion location shall be determined by considering outlet conditions, topography, land use, soil type, length of slope, seep planes (when seepage is an issue) and the development layout. Where practicable, choose a route for permanent structures that avoids trees, existing or proposed service infrastructure, existing or proposed fence lines and other natural or built features.
- **Capacity:** The minimum capacity required is to confine the peak rate of runoff from the 100 year design storm, including a sufficient safety margin.

The following methodology shall be applied:

1. Determine the peak discharge (in m<sup>3</sup>/s) for the area that drains into the channel using the approach outlined in Section 6.9.1 of the Standard.
2. Calculate the capacity of the diversion channel/bund using the following formula:

$$Q = \frac{A R^{2/3} S^{1/2}}{n}$$

where	A	=	Cross Sectional Area (m <sup>2</sup> )
	R	=	Hydraulic Radius (m)
	S	=	Longitudinal Slope (%)
	n	=	Roughness Coefficient (no unit)
	Q	=	Discharge (m <sup>3</sup> /s)

3. Ensure that the channel can convey the peak discharge flow volume calculated above with at least 10% freeboard.

As a guide the following values in Table 8-3 should be used in the calculation (although generally use the overland surface values):

**Table 8-3 Mannings roughness coefficient for a range of materials**

Surface material	Mannings roughness coefficient (n)
<b>Pipes and Man-made Channels</b>	
Brick	0.015
Cast-iron, new	0.012
Concrete - Centrifugally spun	0.013
Concrete - Steel forms	0.011
Concrete - Wooden forms	0.015
Concrete/ Asphalt	0.011
Corrugated metal	0.022
Galvanized iron	0.016
Kerb and Channel	0.018
Plastic	0.009
<b>Natural Channels</b>	
Clean and straight	0.03
Winding with some pools and shoals	0.04
Very weedy, deep pools	0.1
Mountain streams	0.045
Major streams (width greater than 30m at flood stage)	0.025 - 0.1
<b>Overland surfaces</b>	
Concrete/ Asphalt	0.011
Short Grass	0.15
Light Turf	0.2
Lawns	0.25
Dense Turf	0.35
Pasture	0.35

- Cross Section:** The diversion channels shall be parabolic or trapezoidal in shape. The formula used to calculate the cross-sectional areas (A) and hydraulic radius (R) required for the calculation of capacities is outlined in Figure 8-3.

Ensure the internal sides of the bund associated with the diversions are no steeper than 3:1, and the external sides no steeper than 2:1 as outlined in Figures 8-4 and 8-5 below.

**Figure 8-3 – Area and Hydraulic Radius calculations for parabolic and trapezoidal profiles.**

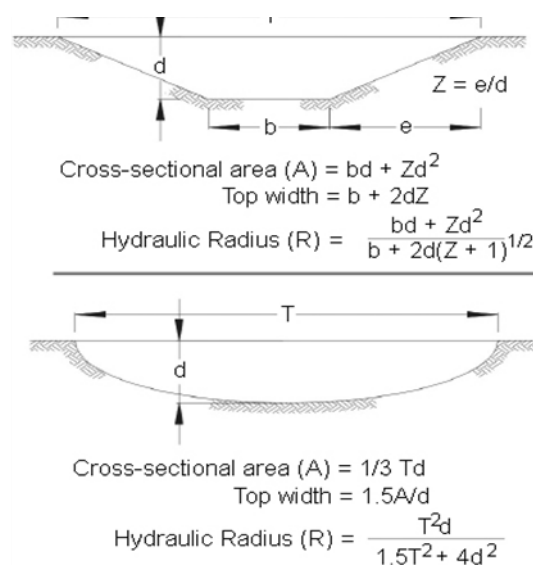

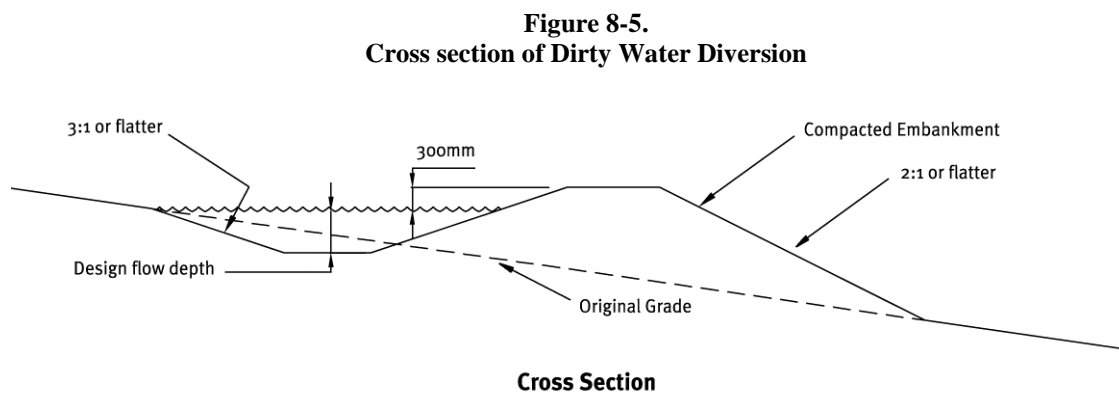
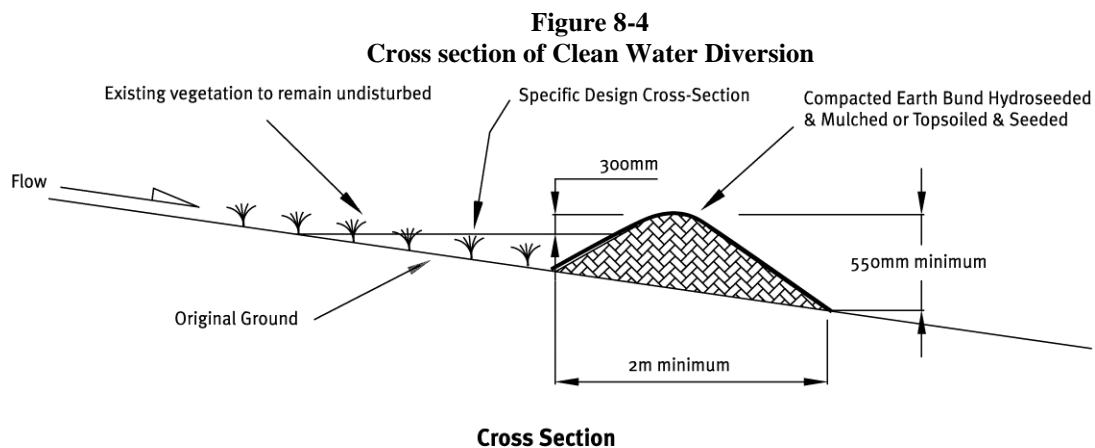

- **Stability of Structure:** Ensure the bunds associated with the runoff diversion channels are well compacted, and stabilised. In some instances, this may require specific geotechnical design to ensure the stability and integrity of the structure.
- **Velocity and Grade:** The design velocity for the specified method of stabilisation will determine the maximum grade. If there is no vegetation as a channel liner, then use the following table below to determine maximum velocities before channel protection is required.

**Table 8-4 Maximum permissible velocities (Fortier and Scobey, 1926)**

Material	Velocity (m/s)
Fine sand (colloidal)	0.46
Sandy loam (noncolloidal)	0.53
Silt loam (noncolloidal)	0.61
Alluvial silt (noncolloidal)	0.61
Ordinary firm loam	0.76
Volcanic ash	0.76
Fine gravel	0.76
Stiff clay	1.14
Graded loam to cobbles (noncolloidal)	1.14
Alluvial silt (colloidal)	1.14
Graded silt to cobbles (colloidal)	1.22
Coarse gravel (noncolloidal)	1.22
Cobbles and shingles	1.52
Shales and hard pans	1.83

It is important to note that the calculated velocities shall use the 1% 1-hour storm event.

- **Outlets:** Each diversion must have an adequate outlet. The outlet may be a stable channel (e.g. rip-rap, geotextile), vegetated or paved area, stable watercourse or pipe outlet. In all cases the outlet must convey runoff to a point where outflow will not cause damage (erosion, flooding). Vegetated outlets shall be installed before diversion construction, if needed, to ensure establishment of vegetative cover in the outlet channel.

The design elevation of the water surface in the diversion shall not be lower than the design elevation of the water surface in the outlet at their junction when both are operating at design flow.

- **Stabilisation:** Diversions shall be stabilised in accordance with the stabilisation specifications outlined in Sections 8.1.2.1 to 8.1.2.5 of this guideline.

### 8.3.5 Maintenance

Runoff diversion channels/bunds require regular maintenance to ensure that they keep functioning throughout their life and consist of the following:

- Inspect weekly, after every rainfall and during periods of prolonged rainfall for scour and areas where they may breach. Repair immediately, if required, to ensure that the design capacity is maintained,
- Remove any accumulated sediment deposited in the diversion channel where there is a risk of overtopping due to a lack of freeboard,
- Check invert and outlets to ensure that these remain free from scour and erosion. These points may require geotextile lining to avoid this effect,
- Look for low spots, areas of water ponding, formation of tunnel gullies, sediment deposition and debris blockage,
- Check for stabilisation cover and ensure full stabilisation cover remains where required, and
- Bunds need particular care to protect against damage from earthmoving operations and should be reinstated if damaged.

### 8.3.6 Decommissioning

In decommissioning diversion channels and bunds fill in the channels and spread bunded area and then stabilise.

## 8.4 Pipe drop structure and flume

### 8.4.1 Definition and purpose

Pipe drop structures and flumes are temporary pipe structures or constructed flumes placed from the top of a slope to the bottom of a slope.

The purpose of the device is to:

- Convey either clean or dirty surface runoff down slopes without causing erosion.

### 8.4.2 Conditions where practice applies

The practice is used where concentrated flow of surface runoff is to be conveyed down a slope. In general, two types of devices are utilised (pipe drop structures and flumes).

- Pipe drop structures or flumes may be either temporary or permanent structures.
- Both pipe drop structures and flumes are commonly used in association with diversion channels which act to collect and direct surface runoff into the structure.
- Flumes may be used to divert flows down batters to the forebay of sediment retention ponds and also at the final point of discharge into receiving environments.
- Flumes may also be used to stabilise an active gully head.

### 8.4.3 Limitations

Pipe drop structures and flumes have the following limitations:

- Severe erosion may result when the drains fail by overtopping, piping or pipe separation.
- Pipe drop structures are suitable up to a maximum catchment of 1ha before specific engineering design is required. Flumes may be utilised up to 5ha.
- Damage to the pipe drop structure or flume may result from slippage or slumping caused by unstable foundation material.
- They require regular monitoring and maintenance to ensure that the structures are operating effectively.

### 8.4.4 Key design criteria

Temporary pipe drop structures or flumes may be fabricated from needle-punched geotextile fabric, concrete, steel or plastic half-round pipes, rock, sandbags, lay-flat or construction ply. Any number of products can be used, provided they can convey water safely over exposed soils or unstable slopes.

Flume conveying dirty water into sediment retention pond



Geotextile lined flume



The following design criteria are relevant:

- Always use flumes/pipe drop structures where slopes are steeper than 3:1 and where channelised surface runoff must be conveyed down the slopes. Ensure that both of these practices have a minimum slope of 3% to avoid sediment deposition within the structure.
- The pipe drop structure or flume should be impervious and must prevent water from flowing under the structure.
- Ensure that the height of runoff diversion channel or bund (when measured from the invert) that is used to divert flows to the pipe drop structure or flume is at least 2x the pipe diameter or 2x the height of the flume.
- The inlet to the flume or pipe should include a 1m long stabilised entry apron (e.g. by using geotextiles as outlined in Subsection 8.3.5) to minimise draw down scour. This needs to be on at least a 3% grade.
- The flume and pipe drop structure shall be extended beyond the toe of the slope being protected and the outfall shall be appropriately protected with an energy dissipation device (e.g. geotextile, sand bags, rip rap).
- Design details are outlined in Figure 8-5.
- Pipe drop structure:
  - Table 8-5 provides general guidance on the maximum catchment area draining into a pipe drop structure. However, these sizings should be consistent with runoff velocities and volumes as defined by the methodology in Section 6.0 of this Standard. Figure 8-6 provides a schematic of the drop structures.
  - For catchments larger than 1ha, pipe sizing will require specific engineering design using the methodology in Section 6.0.
  - The pipe drop structure must provide:
    - Gradient no shallower than 5:1 (20%);
    - Minimum of 2x height of the pipe drop structure of compacted material of inlet bank or wing walls at the top of the pipe;

**Wooden flume lined with impervious material**

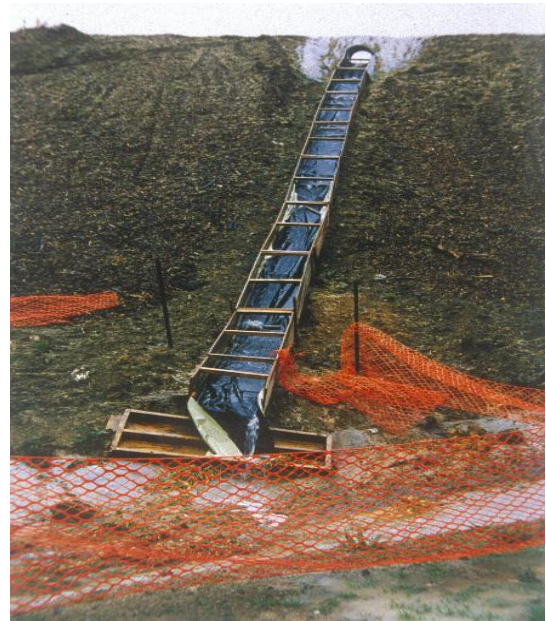

**Table 8-5 Sizing criteria for pipe drop structure**

Pipe diameter (mm)	Maximum catchment area (ha)
150mm	0.05ha
300mm	0.20ha
450mm	0.60ha
500mm	1.00ha
600mm	1.00ha

**Figure 8-6. Flume and Pipe Drop Structure Design**

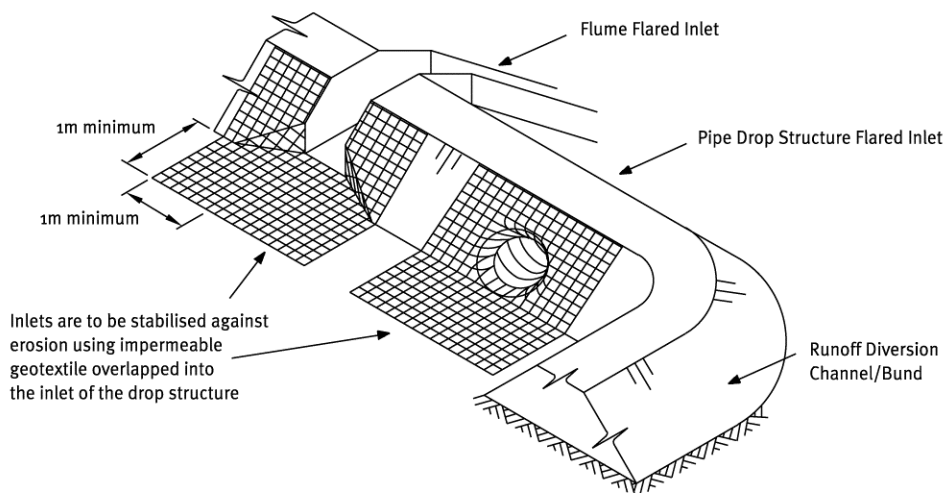
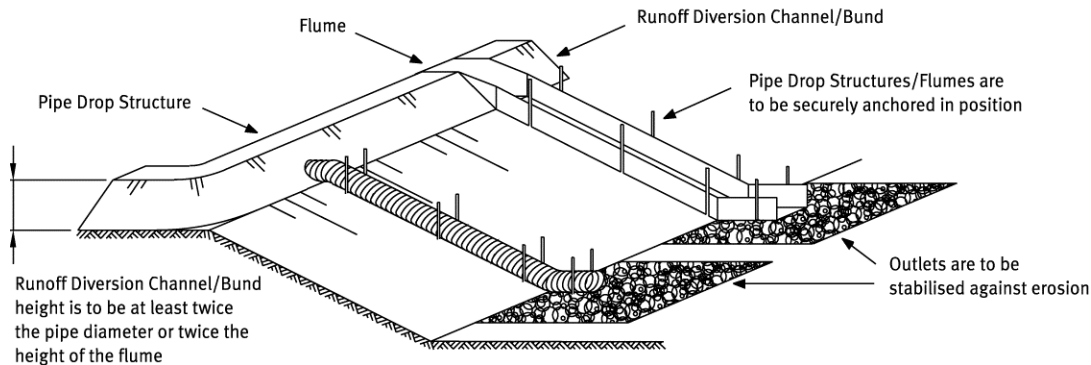

- Flumes

- Temporary flumes shall be limited to the catchment areas as outlined in Table 8-6:

**Table 8-6 Sizing criteria for flumes**

Catchment slope (%)	Maximum catchment area (ha)
>10%	2.5ha
<10%	5.0ha

- When contributing catchments exceed these thresholds, specific engineering design will be required using the methodology in Section 6.0 of this Standard.
- The temporary flumes must provide:
  - An effective flume width of 1.5m/ha of contributing catchment area;
  - Gradient no shallower than 5:1 (20%);

- Minimum of 2x height of the flume of compacted material of inlet bank or wing walls at the top of the flume;
- Minimum of 300mm deep cut-off trench at top of flume to avoid undercutting the fabric;
- Minimum of 300mm flume sidewall height (or flume depth).

### **8.4.5 Maintenance**

Pipe drop structures and flumes require regular maintenance to ensure they keep functioning throughout their life, consisting of the following:

- Inspect the pipe drop structure or flume weekly, after each rain event and immediately carry out any maintenance required,
- Keep the inlet open at all times,
- Check for evidence of water bypassing, undermining or water overtopping the pipe drop structure or flume,
- Check for scour at the base of the pipe drop structure or flume or in the receiving downstream area. If eroded, repair damage and install additional energy dissipation measures. If downstream scour is occurring, it may be necessary to reduce flows being discharged into the device unless other preventative measures are implemented,
- Extend the length of the pipe drop structure or flume as earthworks progress and repair and/or modify pipe drop structure or flume as required,
- Keep pipe drop structures or flumes in place until runoff has been controlled and all disturbed areas have been stabilised, or until permanent stormwater systems have been commissioned, and
- Make sure water is not ponding onto inappropriate areas (e.g active traffic lanes, material storage areas etc.).



## 8.5 Stabilised Entranceway

### Stabilised Entranceway

#### 8.5.1 Definition and purpose

A stabilised entranceway is a stabilised pad of aggregate on a woven geotextile base located at any entry or exit point of a construction site.

The purpose of a stabilised entranceway is to:

- Prevent site access points becoming sources of sediment.
- To assist in minimising dust generation and disturbance of areas adjacent to the road frontage by providing a defined entry and exit point.



Some circumstances may require a formal wheel wash or a vibrating cattle grate system (shaker ramps) to operate effectively.

#### 8.5.2 Conditions where practice applies

Stabilised entranceways apply:

- At all points of construction site entry and exit, and limit traffic to these accessways only, and
- Where necessary, install entranceway in association with shaker ramps or wheel wash facilities as close as possible to the boundary of the works area.

#### 8.5.3 Limitations

Stabilised entranceways have the following limitations:

- Stabilised entrance ways will reduce sediment movement, but will not eliminate it completely. Care needs to be taken to implement other management techniques (e.g. wheel wash) to reduce the potential for vehicles to transport sediment on to road surfaces.
- The use of a wheel wash system in association with a stabilised entranceway can be expensive, but will provide much higher efficiencies in terms of sediment removal.
- Do not locate stabilised entrance ways on steep slopes, in areas of concentrated flows, or next to watercourses or stormwater catchpits.

#### 8.5.4 Key design criteria

Formal design of stabilised entranceways is generally not required although the following design principles are required for them to be an effective practice:

- Once a suitable location for a stabilised entranceway has been determined, clear the area of unsuitable material and grade the base to a smooth finish. Place woven geotextile over this area ensuring this is appropriately pinned (pin edges down) and overlapped as necessary.

- Place aggregate from the construction site boundary extending for at least 10m according to the specifications in Table 8-7 and Figure 8-7 and contour the aggregate to suit the entrance point. Note that contouring can include a highpoint on the grade to act as a barrier to water flowing out of the site.

**Table 8-7 Stabilised entranceway specifications**

Aggregate Size	50 - 150 mm washed aggregate
Minimum Thickness	150mm or 1.5 x aggregate size
Minimum Length	10 metres length recommended
Minimum Width	4 metres minimum

- Provide drainage from the stabilised entranceway to an appropriate discharge point. This may require a sediment control device (especially if a wheel wash is installed).
- Stabilised entrance ways do not necessarily need to be located at the permanent site entry/exit point; however, consideration needs to be given to minimising the number of site entry and exit points.
- Locate all stabilised entrance ways so that vehicles cannot bypass these devices. Perimeter silt fences or bunds may assist in achieving this requirement.
- When used with a shaker ramp;
  - If a shaker ramp is to be utilised this could be in the form of a prefabricated “cattle stop” and must be a minimum of 5m long to allow at least one full revolution of a truck tyre.
  - Two cattle stops should be placed one in front of the other to provide enough length.
  - Stabilise the section of access road between the shaker ramp and the sealed pavement with rock.
  - Ensure the runoff from the shaker ramp area and/or wheel wash systems passes through an appropriate sediment control device.

**Example of Shaker Ramp (Photo – Contractor’s-  
Services LLC)**



**Example of Truck Wash & Shaker Ramp**



**Figure 8-7**  
**Stabilised Entranceway**

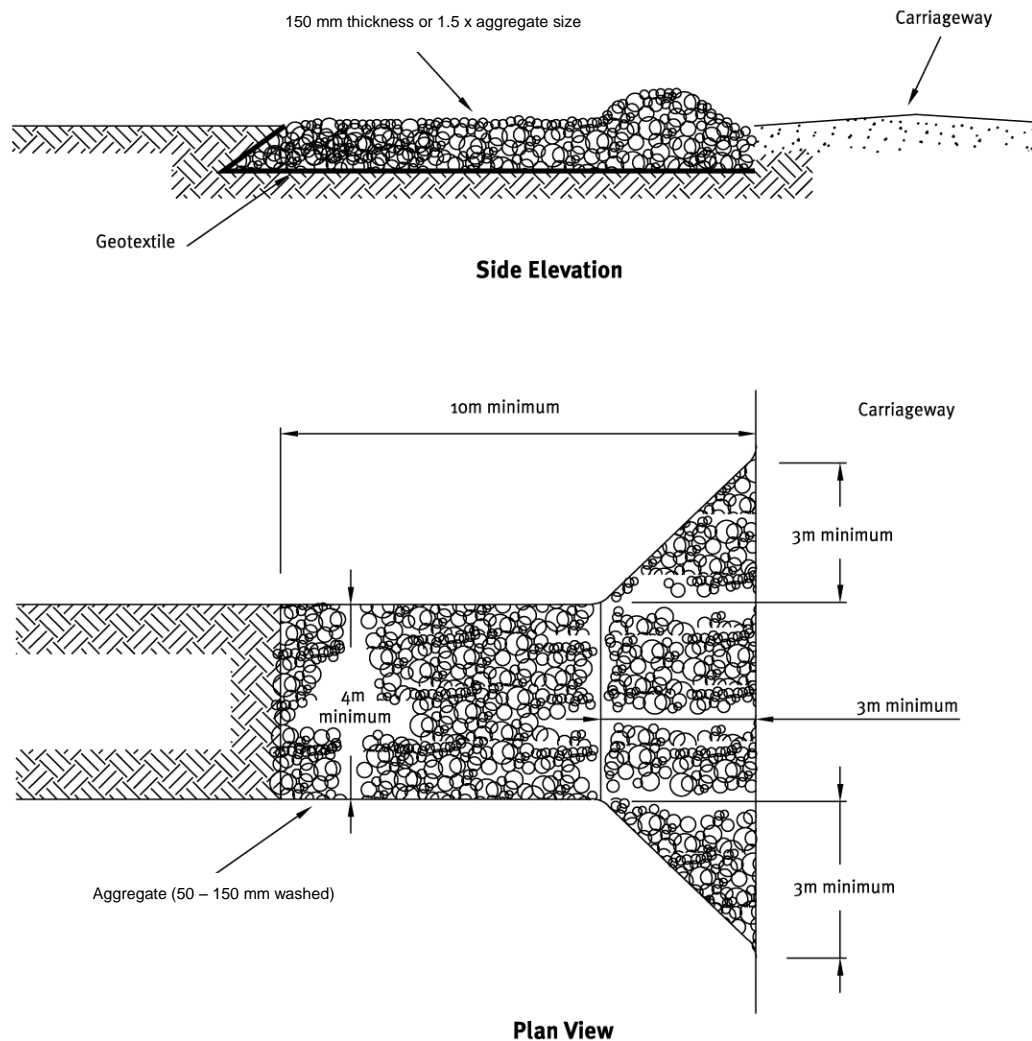

- When used with a wheel wash:
  - Where used in association with wheel wash facilities ensure that a water collection and disposal methodology (can include water recirculation) is provided, and
  - If wheel wash runoff cannot be disposed of appropriately in the immediate vicinity, then all overflow should be directed to a sediment control device within the site.
  - Wheel washes work well for sands and silt material but when working with clay soils a water blaster is a more effective practice and the preferred option.

### 8.5.5 Maintenance

Key items to check as part of the regular maintenance inspection includes:

- Inspect weekly and after each rainfall event for general maintenance requirements.
- Maintain the stabilised entrance way in a condition to prevent sediment from leaving the construction site. This may require several applications of new aggregate during the life of the practice.

- After each rainfall inspect any structure used to trap runoff from the stabilised entrance way and clean out as necessary.
- When wheel washing is also required, ensure this is done on an area stabilised with aggregate which drains to an approved sediment retention facility.
- Add further aggregate as necessary when mud blockage becomes evident or when aggregate thickness is not to specification.
- Remove sediments from sealed pavements by sweeping or vacuuming as necessary. Do not wash any sediment into the stormwater system or any adjoining watercourse.
- In association with stabilised entrance ways, supplementary street sweeping on adjacent roads at regular intervals may still be required.

### **8.5.6 Decommissioning**

In decommissioning stabilised entranceways remove aggregate and geotextile, and stabilise the area. At this point ensure that traffic is kept off of the area.

## 8.6 Surface Roughening

### 8.6.1 Definition and purpose

Surface roughening is roughening the surface of unstabilised (bare soil) earth surface with horizontal grooves extending across the slope or by tracking with construction equipment.

The purpose of surface roughening is to:

- Alter the construction surface soil profile to promote infiltration and increase flowpath lengths. Surface roughening is a technique that will change the roughness coefficient so as to reduce the potential for sediment generation.
- Assist in capturing small quantities of sediment in the “hollows”.
- Rip or scarify bare soil and break up hard or compacted surfaces before seeding for either temporary or permanent revegetation programmes.

Surface roughening with bulldozer



When considering surface roughening, also consider other alternatives for example, geotextiles, plastic covers and erosion and sediment control blankets as per section 8.12.

### 8.6.2 Conditions where practice applies

Surface roughening is a simple technique that should form part of any works methodology on any slopes that have the potential to generate sediment.

When undertaking surface roughening, in particular prior to final site stabilisation, consider what the landscaping requirements are. They should be consistent.

While there are indications that slope compaction through rolling may reduce slope erosion, it is not generally recommended due to compaction increasing surface runoff at higher velocities possibly causing erosion below the slope. Slope compaction or cover by an impermeable liner should only be considered on a case-by-case basis and consideration of down slope erosion concerns addressed.

Surface roughening of a slope. Note the hollows acting as “micro” sediment traps



### 8.6.3 Limitations

Surface roughening has the following limitations:

- Surface roughening will not generally provide a satisfactory level

of erosion control during high-intensity or long-duration rainfall events. Therefore, the technique cannot be relied upon as the only form of control and will require other devices to assist with the control of sediment from the site.

- Ripping or scarification may allow water to enter dispersible soils or soils that are vulnerable to tunnelling thereby exacerbating erosion.
- Do not roughen cut batters in highly erodible soils (e.g. pumice soils, loess), to the extent that scarification lines are likely to collect water in channels or rills.
- Do not surface roughen very dry, fine-textured soils, as they may be prone to pulverisation, making them more susceptible to detachment and transport by either wind or water.

#### **8.6.4 Key design criteria**

There are no formal design criteria for surface roughening although the following principles apply:

- Intercept water that flows onto the works area and divert it away from the area(s) to be roughened prior to undertaking the works.
- Fill existing rills before roughening or track-walking a batter face. Roughening must be done on the contour and in a direction perpendicular to surface water flows.
- Track-walking must leave well-defined cleat impressions in the soil, parallel to the contour. This is necessary in order for the creation of a series of mound and hollow features to act as micro sediment traps.
- When track-walking topsoil material, take care not to compact it so that the soil structure is not destroyed for plant and seed germination.

#### **8.6.5 Maintenance**

Periodically check the slopes for signs of erosion (rills and channels). Rework and/or reseed the area as necessary.

#### **8.6.6 Decommissioning**

Check slope for any rilling or erosion, topsoil the area and stabilise.

## 8.7 Benched Slopes

### Benched slope in conjunction with progressive stabilisation

#### 8.7.1 Definition and purpose

Benched slopes entail grading of sloped areas to form reverse sloping benches of a site in a way so as to minimise potential erosive forces. Another method of breaking up the slope is to use filter socks as flow diverters.

The purpose of a benched slope is:

- To break up the catchment of a worked face and limit the velocity and volume of flows down the slope, and
- To provide for erosion control and vegetative establishment on those areas which are more prone to erosion due to topography.



#### 8.7.2 Conditions where practice applies

This practice is typically used:

- On long slopes and/or steep slopes where rilling may be expected as runoff travels down the slope. They can be an alternative to temporary contour drains.
- In conjunction with geotechnical design to ensure the long-term stability of the slopes.

#### 8.7.3 Limitations

Benched slopes have the following limitations:

- Be aware of geotechnical considerations and check local council requirements. Subsoil drainage may need to be installed where necessary to intercept seepage that would adversely affect slope stability or create excessively wet site conditions.
- Do not construct benched slopes close to property boundaries where they could endanger adjoining properties without adequately protecting such properties against sedimentation, erosion, slippage, settlement, subsidence or other related damages.
- Fill material should be free of brush, rubbish, rocks, logs, stumps, building debris and other objectionable material.
- All disturbed areas should be stabilised in accordance with the standards and specification for mulching and vegetative stabilisation.

#### 8.7.4 Key design criteria

Although design of the bench slopes will primarily depend on site conditions, they should in general be designed in accordance with the design specifications detailed in Table 8-8 and Figure 8-8.

- Benching of the slopes should be a minimum requirement on slopes exceeding 25% and greater than 20m in vertical height unless there are geotechnical considerations preventing this.

- Locate the benched slopes to divide the slope face as equally as possible and convey the water from each bench to a stable outlet (e.g. geotextile, flume or rock rip-rap). Soil types, seeps and location of rock outcrops need to be taken into consideration when designing benched slopes.
- The spacing of each successive bench should as provided for in Table 8-8 below.

**Table 8-8 Benched slope spacings**

Slope of site	Vertical height (m) between benches
50% (1:2)	10
33% (1:3)	15
25% (1:4)	20

- Diversions on benched slopes:
  - Diversions should be provided whenever the vertical interval (height) of any slope exceeds 10m. Diversions shall be located to divide the slope face as equally as possible and convey the water from each bench to a stable outlet (e.g. geotextile, flume or rock rip-rap). Soil types, seeps and location of rock outcrops need to be taken into consideration when designing diversions.
    - Ensure that each diversion is a minimum of 2m wide to enable maintenance of the bench.
    - Diversions shall be designed with a reverse slope of 15% or flatter to the toe of the upper slope and with a minimum depth of 0.3m. The gradient to the outlet should be below 2% unless specific design demonstrates otherwise.
    - The flow length within a diversion should not exceed 250m unless accompanied by an appropriate design and calculations.
  - Surface water should be diverted from the face of all cut and fill slopes by the use of diversions, swales and flumes or conveyed downslope by the use of a designed structure except where:
    - The face of the slope is stabilised by specific erosion control materials.
    - The face of the slope is not subject to any concentrated flows of surface water such as from natural drainage-ways, graded swales, etc.

**Figure 8-8. Benched Slope**

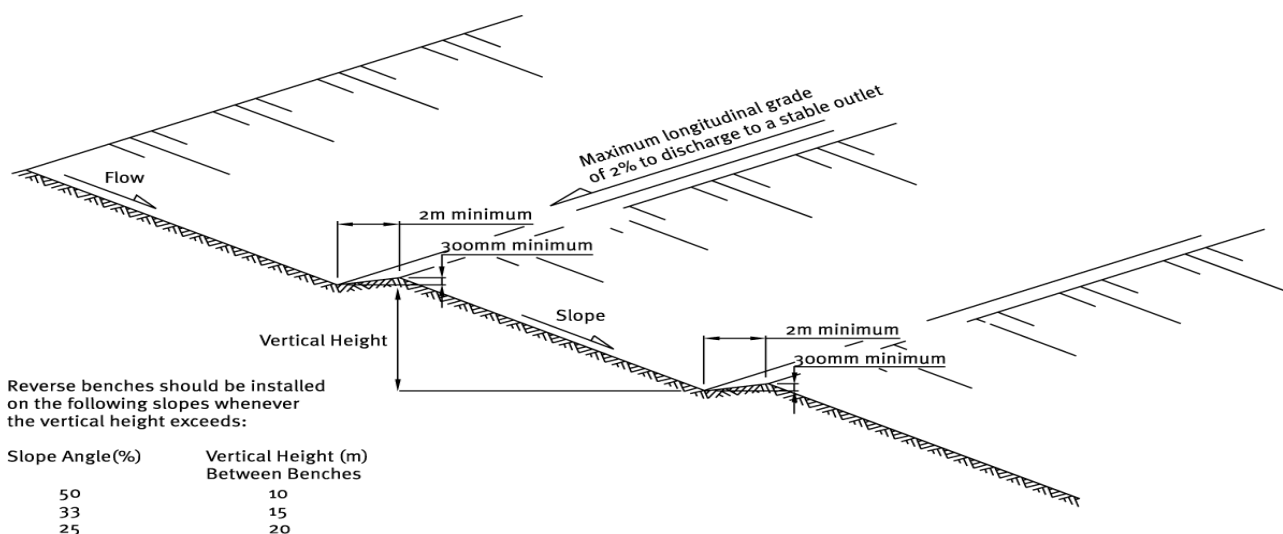



- Filter socks can be installed at regular intervals according to the spacing requirements of Table 8-8 to reduce the effective slope length and limit flow velocities down the slope. As a secondary benefit, filter socks on slopes can remove suspended sediment from runoff. In a similar fashion to slope breaks, the filter sock can be 300 mm in diameter.
- One point that must be recognised is that slope breaks may be permanent drainage diversions where filter socks are only temporary. If they are used temporarily, permanent slope stabilisation must ensure that rills and gullies do not develop.

### 8.7.5 Maintenance

Key items to check as part of the regular inspection includes:

- Repair or reinstate the bench slopes and diversions if destroyed by machinery movement and after rainfall or storms.
- Check the outfall of the diversions for erosion and repair if required. It may be necessary to install a temporary flume or provide geotextile to line these exit points.
- Remove any accumulated sediment within the diversions.

**Filter Socks used for slope flow diversion**  
(image provided by Erosion Control Co. Ltd.)



### 8.7.6 Decommissioning

When decommissioning bench slopes check the slope and bench area for any rilling or scour, then add topsoil and stabilise.

## 8.8 Topsoiling and grass seeding

### 8.8.1 Definition and purpose

Topsoiling and grass seeding involves the planting and establishment of quick growing and/or perennial grass to provide temporary and/or permanent stabilisation on exposed areas. The practice is often undertaken in conjunction with the placement of topsoil.

The purpose of the practice includes the following:

- To provide either a short-term or long-term cover for erosion control on disturbed areas. The established vegetation protects exposed soils from raindrop impact, reduces runoff velocity and volume, binds soil particles together and can also inhibit weed growth.
- As a rapid-growing annual grass will provide a short-term cover. It is primarily used where project works are still progressing but need temporary coverage (e.g. during winter shutdown period).
- The use of perennial grasses will provide permanent erosion protection to disturbed areas following completion of the earthworks activity. Ideally, permanent grassing should be undertaken progressively throughout the project as earthworks are finalised and brought to final grade.
- Topsoiling provides a suitable soil medium for vegetative growth for erosion control while providing some protection of the subsoil layer and also increasing the absorption capacity of the soil.

Grass stabilised earthworks site. Source: Bay of Plenty Regional Council



### 8.8.2 Conditions where practice applies

The practice applies to any site where vegetation establishment is important for stabilisation or landscape purposes.

- Temporary seeding:
  - Use on any cleared or unvegetated areas which are subject to erosion and will not be earthworked for a period of 30 days up to a maximum duration of 12 months.
  - Temporary stabilisation is normally practised where the vegetative cover is required to be in place for less than 12 months. In some circumstances mulching may be used as an alternative.
  - Utilise temporary seeding on short to medium-term stockpiles, the outside of sediment pond embankments or diversion bunds, on cut and fill slopes, access/haul road embankments and any other disturbed area that is likely to remain exposed and unworked for less than 12 months. Permanent seeding may be required for periods greater than 12 months.

- Permanent seeding:
  - This practice applies to any site where establishing permanent vegetation is important to protect bare earth. It may also be used on rough graded areas that will not be brought to final grade for 12 months or more.
- Topsoiling:
  - Topsoil provides the major zone for root development and biological activities as well as having greater available water-holding capacity than clay subsoil layers. Topsoiling is recommended for sites where:
    - The texture and/or the organic component of the exposed subsoil or parent material cannot produce adequate vegetative growth.
    - The soil material is so shallow that the rooting zone is not deep enough to support plants or furnish continuing supplies of moisture and plant nutrients.
    - High quality vegetative cover is required to be established.

### 8.8.3 Limitations

Grass seeding has the following limitations:

- Establishing a protective vegetative sward is difficult during periods of low rainfall or during periods of temperature extremes. Develop construction sequencing such that topsoiling and seeding occurs during optimum periods for vegetation establishment.
- The newly established seed can be mobilised by intense rainfall and may require several applications to achieve the appropriate stabilisation standard.
- Topsoil alone is not considered stabilised and erosion/sediment control measures shall be operational until there is an appropriate density of grass strike (80% cover). Alternatively other stabilisation methods (e.g. mulching) may be used.

### 8.8.4 Key design criteria

The following shall be considered for topsoiling and grass seeding.

- Site preparation:
  - Prior to seeding, install erosion and sediment control practices such as

**Incipient grass strike = not stabilised**



**Approximately 40 – 60% grass strike = not adequately stabilised**



**Approximately 90 – 100% grass strike = stabilised**

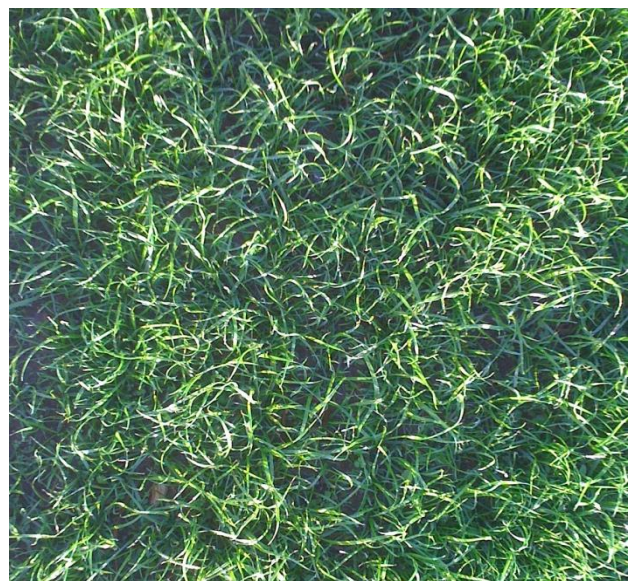

diversions, silt fences, bunds and sediment retention ponds.

- Final grading and shaping is not necessary for temporary seeding.
- Seedbed preparation:
  - It is important to prepare a good seedbed to ensure the success of establishing vegetation. The seedbed should be loose, uniform and free of large clods and other objectionable material. The soil surface should not be compacted or crusted.
  - If the site has contaminated material, ensure that this is fully removed from the topsoil.
  - Apply topsoil at a minimum depth of 100mm to allow for a loose and friable surface.
  - Topsoil is a valuable resource. When placing topsoil in stockpiles ensure that it is isolated by the upslope diversion of clean water runoff, is stabilised appropriately and is not stored in stockpiles greater than 2m in height to maintain soil structure and integrity.
- Soil amendments:
  - Apply fertiliser at the rate outlined in Table 8-9 of this Standard. Confirm that this rate and type of fertiliser is appropriate for site conditions with your fertiliser supplier before using.
  - For large sites or unusual soil conditions, soil testing may be required as some soils may require the addition of lime to improve pH and/or trace elements for grass growth.
- Seed application:
  - Select the seed mixture from Table 8-9. Alternatively, Table 8-11 in Section 8.3.2 of the Standard provides guidance on the appropriate seed mix and proportions for the environment that you are working in.
  - Apply seed uniformly at the rate outlined in Table 8-9. If hydro-seeding is required refer to Section 8.3.2 of the Standard. Traditional agricultural techniques such as drill seeding, broadcast seeding or no tillage are appropriate for establishing grass on areas flatter than 25%. Ensure the methodology achieves a good seed-to-soil contact, thereby enhancing seed survival and germination rates.
  - For small areas hand-broadcasting and raking may also be used to apply seed and fertiliser.
  - Use only fresh, certified seed with a high purity and germination percentage from reputable suppliers that are preferably local. Species selection must consider the project's ecological context and if undertaking permanent seeding, be mindful of the final landscape plans.
  - Apply and maintain fertiliser at the rate outlined in Table 8-9.
  - If irrigation is required, deliver a volume at least equal to the evapotranspiration rate and continue until natural rainfall provides the necessary soil moisture levels for plant survival.
  - Ensure that the site conditions, and the time of the year are appropriate for germination and vegetation establishment prior to undertaking this activity. This may involve the placement of mulch and/or irrigation to achieve.

**Loss of topsoil & grass seed after heavy rain event.  
Will require stabilisation & reapplication.**



- In order to maximise germination and growth rates, the preferred seeding windows for both temporary and permanent grassing are autumn and spring. With the utilisation of mulch or geotextiles to maintain soil temperatures and irrigation to supply moisture, grassing may be done throughout the summer period.
- Mulching as outlined in Section 8.3.3 of the Standard should be undertaken in conjunction with the seeding programme during dry or cold periods. This will protect both the seed and the soil, whilst also providing a better microclimate for the germination and growth of grasses.
- Typically a minimum of 80% ground cover over the entire subject area is considered a stabilised surface. The above photos provide examples of various grass strike densities.

**Table 8-9 Typical seed and fertiliser application rates**

	Typical seed mix <sup>1</sup>	Application rate
<b>Temporary Seeding</b>	Annual Ryegrass	200 kg/ha
<b>Permanent Seeding</b>	Perennial Ryegrass – 70% Fescues/Cocksfoot – 20% Clover/Lotus – 5% Browntop – 5%	200 kg/ha
<b>Fertiliser Application</b>	N:P:K (15:10:10)	250 kg/ha
<b>Maintenance Fertiliser</b>	N:P:K (15:10:10) and Urea	250 kg/ha

### 8.8.5 Maintenance

The following shall be considered for maintaining topsoiling and grass seeding:

- Check the condition of the topsoil on a regular basis and re-grade and/or replace where necessary so as to always maintain the 100mm minimum depth of topsoil and appropriate surface roughening.
- Heavy rainfall can wash new seeding away before full establishment of the grass. This is particularly evident on smoother hard surfaces, steep slopes and overland flow paths. Where vegetation establishment is unsatisfactory, the area will require a reapplication of seed or consideration will need to be given to other stabilisation techniques.
- Apply additional fertiliser dosing at the ratio of 15:10:10 (N:P:K) approximately 6 to 12 weeks after seeding or as required. Apply at the rate of 250kg/ha.
- Protect all re-vegetated areas from construction traffic and other activities such as the installation of drainage lines and utility services. If required, erect temporary barrier fencing and/or signage to restrict uncontrolled movement of equipment and vehicles onto grassed areas.

### 8.8.6 Decommissioning

When decommissioning ensure good stabilisation occurs.

<sup>1</sup> NB: In all circumstances ensure that the seed and fertiliser application rates and mix is appropriate for your site. Always discuss with your seed and fertiliser supplier prior to utilisation.

## 8.9 Hydroseeding

Specialist application of hydroseed. Source: Erosion Control Ltd

### 8.9.1 Definition and purpose

Hydroseeding is the application of seed, fertiliser and paper or wood pulp with water in the form of a slurry, sprayed over an area to provide for re-vegetation.

The purpose of hydroseeding is to:

- Establish grass and other vegetation on steep and/or inaccessible areas.
- Quickly establish vegetation. Hydroseeding is not considered instant stabilisation although the practice will provide limited protection from raindrop impact for a short time until the grass is established.



### 8.9.2 Conditions where practice applies

This practice applies to any site where vegetation establishment is important for stabilisation or landscape purposes. Typically it is used:

- On critical areas such as steep slopes or batters and exposed areas near watercourses that require a more rapid germination and stabilisation than conventional hand seeding.
- On areas that may be difficult to establish by conventional sowing methods (e.g. steep embankments and areas with difficult access).
- Around runoff diversion channels/bunds, where rapid establishment of a protective vegetation cover is required before introducing water flow.

### 8.9.3 Limitations

Hydroseeding has the following limitations:

- Hydroseeding will require specialised equipment to apply and therefore there is a reliance on experienced contractors and local knowledge to ensure that the seed mix is appropriate for the site and conditions.
- Although there is an improved grass strike rate with hydroseeding, it is a more expensive option compared with conventional grass seeding.
- In the period during the winter stabilisation program, the availability of hydroseeding contractors may be an issue and it is recommended that you plan your programme and confirm these contractors well ahead of time.
- The newly established hydroseed can be mobilised by intense rainfall.

Recently applied hydroseed showing emergent grass growth



## 8.9.4 Key design criteria

Prior to applying hydroseed the following shall be considered:

- Match your environment from Table 8-11.
- Using the Options (O), Alternatives (A) together with the Essential Species (E) from Table 8-11 the hydroseeding seed mixes should consist of the following proportions as outlined in Table 8-10 below.

**Table 8-10 Hydro-seeding mixes (Source: Ecotec Systems Ltd)**

Seed mix	Proportion
Perennial Ryegrass or Alternatives/Options	70%
Fescues/Cocksfoot or Alternatives/Options	20%
Clover/Lotus or Alternatives/Options	5%
Other (e.g. Browntop) or Alternatives/Options	5%

- There are various hydroseed mixes which utilise soil improvements, paper or wood pulp and in some circumstances a binder to help seeds adhere to the soil surface. Hydroseed slurry should be applied at a rate of 1200 kg/ha.
- Fertiliser shall be applied at the ratio of 15:10:10 (N:P:K) at a minimum application of 250kg/ha. This may change depending on site soils. For larger applications, a soil test should be done to determine rates and whether an alkaline based fertiliser should be used rather than an acid based one.
- Apply the hydroseed mix via a specialised vehicle mounted cannon, or for inaccessible areas, a hand-held hose and nozzle. In a number of cases, the use of mulch as outlined in Section 8.3.3 over the hydroseed will protect the seed/soil and enhance seed survival and germination rates.
- The area of coverage is not considered to be stabilised until an 80% density of grass cover has been established.

## 8.9.5 Maintenance

The following maintenance requirements are required for hydroseeding:

- Heavy rainfall can wash new hydroseeding away before full establishment of the grass. This is particularly evident on smoother hard surfaces and overland flow paths. Where vegetation establishment is unsatisfactory, the area will require a reapplication of hydroseeding or consideration will need to be given to other stabilisation techniques.
- Apply additional fertiliser dosing at the ratio of 15:10:10 (N:P:K) approximately 6 to 12 weeks after hydroseeding or as required. Apply at the rate of 250kg/ha.
- Protect all re-vegetated areas from construction traffic and other activities such as the installation of drainage lines and utility services. If required, erect temporary barrier fencing and/or signage to restrict uncontrolled movement of equipment and vehicles onto grassed areas.

## 8.9.6 Decommissioning

When decommissioning hydroseeding ensure that good site stabilisation occurs.

**Table 8-11. Hydro-seeding Seed Species Recommendations and Site Specific Suitability. Standard “Base” Species for Revegetation, Erosion Control & Stabilisation (Source: Ecotec Systems Ltd)**

**Key<sup>2</sup> :** E = essential, AE = alternative & essential, O = optional, I = requires inoculant

	Batters/Cuttings (A, B & C Horizon)	Topsoiled Earthworks	Subsoil Earthworks	Coastal High Sand Content	Wetlands and Saline
<b>Perennial Ryegrass</b> – select cultivar for low DM production and deep rooting persistence e.g. Pacific	E	E	E	O	O
<b>Winter Active Perennial Ryegrass</b> – requires reasonable fertility. Active in temperatures from 5°C. Sports turf cultivars such as “Sports Oval”.	O	Temporary O	Temporary O	Temporary O	-
<b>Annual Ryegrass</b> – fast establishment, high DM production, requires med + fertility – generally lower temp tolerant. Cultivars – most Italian Ryegrasses e.g. Tama, H1.	O	O	O	O	O
<b>Fescue Creeping Red</b> – drought & low fertility & saline tolerant. Spreads readily.	E	AE	AE	E	E
<b>Tall Fescue</b> – persistent, drought & fertility tolerant.	AE	AE	AE	O	O
<b>Cocksfoot</b> – drought, low fertility and acid (low pH) tolerant. Cultivars – NZ prostrate habit such as “Tekapo”.	O	O	O	O	O
<b>Browntop</b> – low fert requirement, low DM production. Drought tolerant. Prolific self-seeding. Persistent in low pH soils.	E	O	O	O	O
<b>White Clover</b> – persistent “Huia” cultivar is the highest N fixing clover in NZ.	E, I	E, I	E, I	E, I	E, I
<b>Lotus</b> – very low fertility tolerant, drought & wet tolerant also. High N fixing. Spreads persistently in most situations.	E, I	-	AE, I	E, I	AE, I
<b>Subterranean Clover</b> – very drought tolerant, low fertility.	O, I	O, I	O, I	-	-
<b>Couch Grass or Kikuyu</b> – saline tolerant, low fertility in wet & dry conditions. Spreads profusely. Will grow where most other grasses won’t.	O	O	O	E	E

<sup>2</sup> O and A are not exhaustive and will vary in suitability due to climate and soil characteristics. Specific trace elements added will enhance results in some deficient soils. All variations and options proposed should be accompanied with an explanation of reason by the contractor.



## 8.10 Mulching

### 8.10.1 Definition and purpose

Mulching is the application of a protective layer of straw or other suitable material to the soil surface.

The purpose of mulching is:

- Providing a rapid stabilisation technique to protect the soil surface from the forces of raindrop impact and overland flow.
- To help conserve moisture, reduce runoff and erosion, prevent soil crusting and promote the establishment of desired vegetation. Mulching for erosion control purposes is usually a short to medium-term treatment. It can be used as a stand-alone surface cover or in conjunction with a seed and fertiliser grassing programme.

Although straw (wheat or barley) and hay are the commonly used materials, mulching can also include the application of bark, wood residue and wood pulp spread over the surface of disturbed flatter ground.

### 8.10.2 Conditions where practice applies

Mulching can be used at anytime where protection of the soil surface is desired although the following conditions are particularly applicable:

- Where it is critical to achieve an immediate stabilised surface cover and to maintain this cover for the short to medium term (three to five months). This includes stabilisation of areas that have not been worked for a period of time although are proposed to be worked in the future.
- Where a warmer microclimate is required to maintain soil temperatures and avoiding soil temperature fluctuations which in turn provide for appropriate conditions for seed germination and the establishment of vegetation at most times of the year.
- As an alternative to straw or hay mulch, bonded fibre matrix products can be utilised. These are available from specific stabilisation specialists however it is important to recognise that this surface cover is not considered stabilised until sufficient grass strike has occurred. This product is typically used on steeper slopes (30% to 50%).

**Specialist application of hay mulch.**



**Application of bark mulch.**

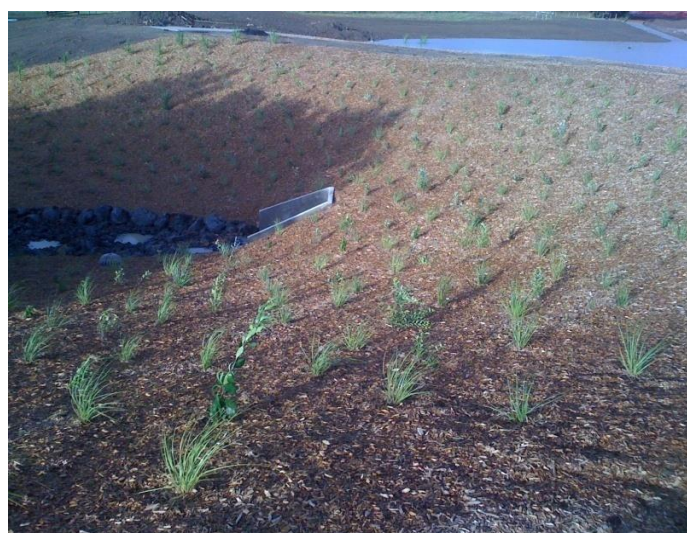

### 8.10.3 Limitations

Mulching has the following limitations:

- Mulching requires specialised equipment for large areas so that a uniform coverage is obtained. Hand mulching can occur on smaller sites.
- Both hay and straw mulch have a limited period of effectiveness. In general, hay will last for three months and straw mulch up to five months before these materials become part of the soil matrix and effective cover is lost.
- Mulching may introduce weed species and in some circumstances may not be an appropriate measure for the site. Care therefore needs to be taken to ensure that weed infestation of the mulched area does not create a future issue.
- In the period during the winter stabilisation program, the availability of mulching contractors may be an issue and it is recommended that you plan your mulching programme and confirm mulching contractors well ahead of time.
- Mulch can be dislodged by intense rainfall or very high winds.
- Mulch is not an appropriate cover in areas of concentrated flow paths or in stream channel systems. Care is needed so the mulch does not block chemical treatment devices or interrupt the operation of decants in ponds.

### 8.10.4 Key design criteria

Prior to applying mulch, the following shall be considered:

- Straw or hay mulch shall be unrotted material applied at a rate of 6,000kg/ha. As a “rule of thumb” a 30mm loose thickness (measured at time of application) is the required coverage and is considered to be in a stabilised state. Mulch material shall be relatively free of weeds and not contain noxious weed species. A list of noxious weeds can be obtained from the relevant Local Authority.
- Hydro mulch applications must contain a minimum of 80% virgin or recycled wood and be undertaken in accordance with the manufacturer’s specifications. The application rate will range from 2,200kg/ha to 2,800kg/ha depending on the slope gradient. The coverage should not to exceed slope lengths greater than 150m.
- Wood chip can be applied at rates of around 10,000kg/ha to 13,000kg/ha when available and feasible. Bark mulch is generally slow to deteriorate but can affect soil nitrogen levels making it unavailable to plants. It can also result in saps and tannins leaching and causing a change in pH. Care needs to be taken when applying wood chip adjacent to watercourses and on steeper slopes.

**Application of bonded fibre matrix**  
Source: Flexterra



**Mulch Cover – approximately 20 – 40% density = inadequate cover for stabilisation**

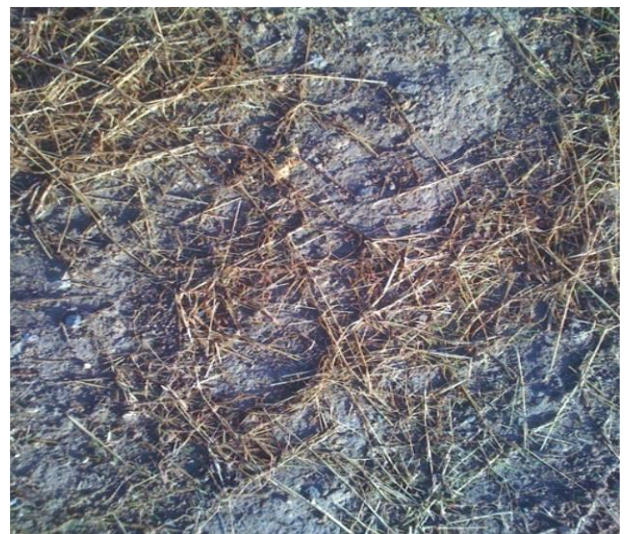

- If site conditions result in difficulties with the mulch material remaining on site (e.g. during windy conditions), the mulch will need to be anchored. Forms of anchoring comprise:
  - Crimping - using a tractor drawn implement designed to punch and anchor mulch into the top 5cm of the soil profile. On sloping land, crimping should be done on the contour whenever possible.
  - Binders or tackifiers can be applied directly as the mulch is being distributed at an application rate that matches the manufacturer's specifications for that specific binder.

**Mulch Cover – approximately 100% density = adequate cover for stabilisation**



### 8.10.5 Maintenance

The following maintenance requirements are required when mulch is used:

- Inspect after each rainfall event or periods of excessively strong winds, and repair or replace any areas of damaged cover.
- Construction equipment can cause disturbance to stabilised areas and may require the erection of a temporary barrier and/or signage to restrict the movement of equipment and vehicles onto mulched areas.
- For optimal protection, 100% surface cover must be maintained and a reapplication will be required when the integrity and/or surface density has declined.

### 8.10.6 Decommissioning

Ensure good site stabilisation occurs following mulching.

## 8.11 Turfing

### 8.11.1 Definition and purpose

Turfing is the establishment and permanent stabilisation of disturbed areas by laying a continuous cover of grass turf.

The purpose of the practice is to:

- Provide rapid stabilisation by the placement of vegetative cover to stabilise exposed areas.
- Turfing (“instant lawn”) may also be used to establish a vegetative filter or buffer along footpaths, driveways, kerbs and channels. The practice provides instant results from a visual and erosion control perspective.



### 8.11.2 Conditions where practice applies

This practice is typically used where:

- Critical erosion prone areas on the site that cannot be stabilised by conventional sowing or other stabilisation methods.
- Runoff diversion channels and other areas of concentrated flow where velocities will not exceed the specifications for a grass lining.
- Areas around grass stormwater inlets, swales, embankments, road berms and other areas that require immediate grass cover for landscaping purposes.

### 8.11.3 Limitations

Turfing has the following limitation:

- Turfing can be a relatively expensive option to achieve a stabilised surface although it has the dual advantage of providing erosion control as well as being suitable for landscaping of a feature.

### 8.11.4 Key design criteria

Prior to turfing the following shall be considered:

- The following criteria should be met for sod placement:
  - Rake soil surface to break crust prior to laying turf.
  - During periods of high temperature, lightly irrigate the soil immediately prior to placement. Do not install on hot, dry soil, compacted clay, frozen soil, gravel or soil that has been treated with pesticides.

- 
- Turf strips should be laid on the contour, never up and down the slope, starting at the bottom of the slope and working up. Install strips of turf with their longest dimension perpendicular to the slope and stagger the joints.
  - Do not stretch or overlap.
  - All joints should be butted tightly to prevent voids which would cause drying of the roots. Also, open spaces may cause erosion.
  - On slopes steeper than 3H:1V, secure turf to surface soil with wood pegs, wire staples or split shingles. Use of ladders will facilitate work on steep slopes and prevent damage to the turf.
- Roll and tamp turf immediately following placement to ensure solid contact of root mat and soil surface
  - Care needs to be taken to ensure that flow velocities travelling over the turfed area will not cause erosion. In these circumstances which often relate to steeper areas, turf reinforced with geotextiles should be considered. Refer to manufacturers' specifications for flow velocities applicable for the various geotextiles.

### **8.11.5 Maintenance**

The following maintenance requirements are required for turfing:

- Water daily during the first week of laying the turf unless there is adequate rainfall.
- Check to ensure that the turf is firmly rooted to the original ground surface. Do not mow the area until the turf is firmly rooted.
- Apply fertiliser as required in accordance with supplier's specifications.

### **8.11.6 Decommissioning**

Once turfing is completed ensure good site stabilisation occurs.

## 8.12 Geotextiles, plastic covers, erosion control blankets and geo binders

### 8.12.1 Definition and purpose

Geotextiles, plastic covers and erosion control blankets entail their placement to stabilise disturbed soil areas and protect soils from erosion by wind or water.

The purpose of the practice is to:

- Instantly reduce the erosion potential of the disturbed areas and/or reduce or eliminate erosion on critical sites.
- Be used as a permanent or temporary measure to control erosion.

Geotextile used as a temporary stabilising agent on cut embankment.



### 8.12.2 Conditions where practice applies

These measures are used when disturbed soils may be particularly difficult to stabilise, including the following situations:

- In critical erosion-prone areas such as sediment retention pond outlets and inlet points.
- In channels (both perennial and ephemeral) where the design flow produces tractive shear forces greater than existing soils can withstand which leads to erosion of the soil surface. The maximum velocity before channel lining is required is outlined in Table 8-4 of Subsection 8.2.3.
- On a temporary basis in areas where there is inadequate space to install sediment controls.
- In areas that may be slow to establish an adequate permanent vegetative cover. In this situation, the geotextile provides an early protective layer as well as assisting in maintaining a higher soil temperature.
- On short steep slopes, batters, stockpiles, or preloading during periods of inactivity on the site.
- In situations where tensile and shear strength characteristics of conventional mulches limit their effectiveness in runoff velocities such as overland flowpaths.
- In areas where the downstream environment is of high value and rapid stabilisation is required.

### 8.12.3 Limitations

The practice has the following limitations:

- Blankets and mats are more expensive than other erosion control measures due to labour and material costs. This usually limits their application to areas inaccessible to hydraulic equipment or where other measures are not applicable.
- Blankets and mats are generally not suitable for excessively rocky sites, or areas where the final vegetation will be mowed as the staples and netting can catch in mowers.
- Blankets and mats must be removed and disposed of prior to application of permanent soil stabilisation measures.

- Geotextiles do not generally provide the same level of benefit to soil quality as many of the traditional mulches (e.g. straw mulch). Most geotextiles have a limited working life of generally no more than 6 to 9 months, and some materials may be prone to UV degradation. The material can be flammable and can be subject to vandalism.
- Some geotextiles may contain a fine synthetic mesh or netting that can pose a threat to a number of aquatic species or birds.
- The use of plastic shall be limited to covering stockpiles, or very small graded areas for short periods of time until alternative measures such as seeding and mulching may be installed.
- Geotextiles, mats, plastic covers and erosion control covers have maximum flow rate limitations; consult the manufacturer for proper selection.
- Once an area has been treated with a geobinder, the area cannot be disturbed, as any damage to the crusted surface will result in spot failures and require maintenance.

**Bidum Geotextile. Source: Maccaferri NZ Ltd**



#### 8.12.4 Key design criteria

The use of geotextiles is typically categorised into temporary degradable geotextiles and permanent non degradable geotextiles.

Erosion control batter blankets are a specific group of proprietary rolled erosion control products commonly made from biodegradable materials. They provide an instant, short to medium-term protective cover of the soil surface, shielding it from the erosive forces of wind, raindrop impact and sheet flows until a vegetative sward can be established or an alternative stabilisation methodology is utilised.

In all circumstances for specific construction specifications, refer to the product information sheets supplied by the manufacturer. In general, the requirements for the various measures comprise:

- Geotextiles, the following specifications shall apply:
  - Material shall be a woven polypropylene fabric with minimum thickness of 1.5mm; minimum width of 3.7m and minimum tensile strength of 0.67 kN (warp) and 0.36 kN (fill) in conformance with the requirements of ASTM Designation: D4632.
  - The permittivity of the fabric shall be approximately 0.07 sec in conformance with the requirements of ASTM Designation: D4355.

**Figure 8-9. Geotextile Design**

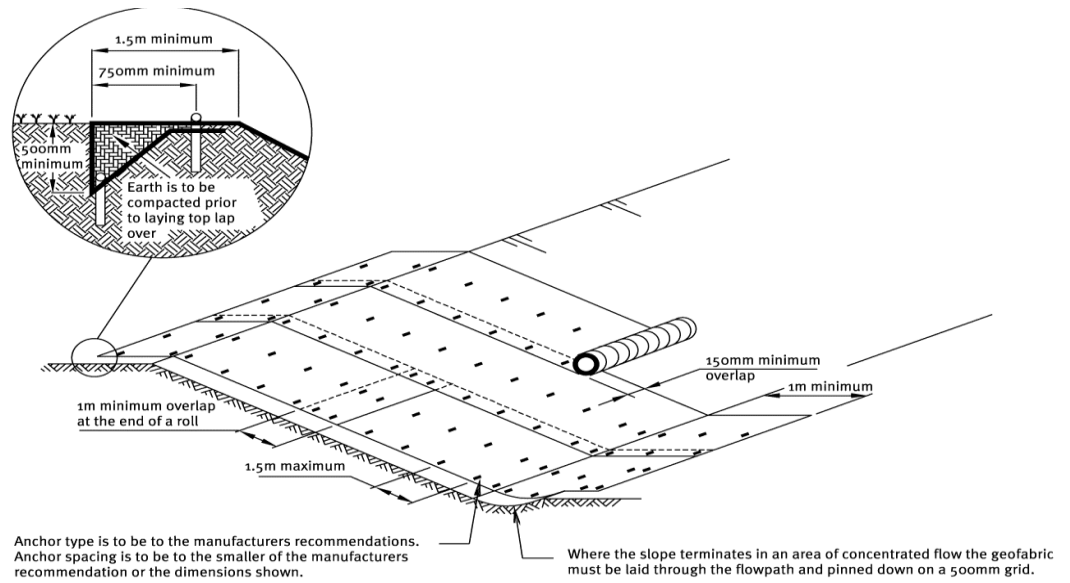

- Geotextile blankets shall be secured in place with wire staples or sandbags and by keying into the tops of slopes and edges to prevent infiltration of surface water under the geotextile.
- Staples shall be made of 3.05mm steel wire and shall be U-shaped with 200mm legs and 50mm crown.
- Specifications for installation are outlined in Figure 8-9 and 8-10.
- In all circumstances pin geotextiles down on a 500mm grid. This is critical in ensuring an appropriate number of contact points with the underlying soil and ensuring that wind does not cause the geotextile to lift from the slope it is protecting.

**Figure 8-10. Geotextile Design**

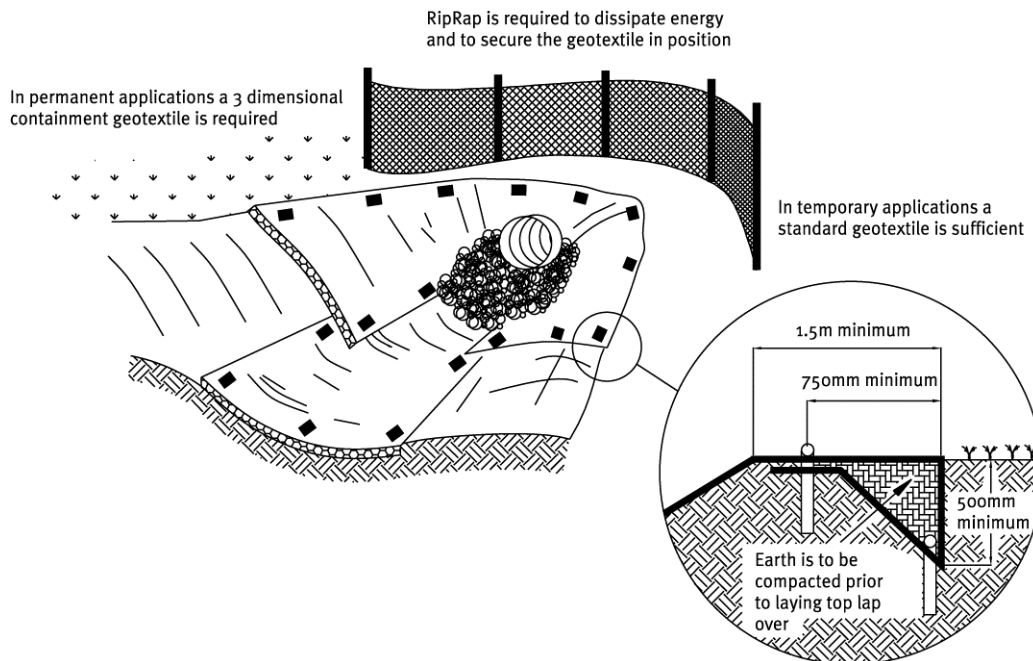



- Plastic covers, the following specifications shall apply:
  - Plastic sheeting shall have a minimum thickness of 6mm and be keyed in at the top of the slope and firmly held in place with sandbags or other weights placed no more than 3m apart.
  - Seams are typically taped or weighted down their entire length with at least a 300mm to 600mm overlap of all the seams.
- Edges shall be embedded a minimum of 150mm into the soil.
- Erosion control blankets/mats
  - Biodegradable rolled erosion control products
    - Biodegradable rolled erosion control products (RECP's) are typically comprised of jute fibres, curled wood fibres, straw, coconut fibre or a combination of these materials. For a RECP to be considered 100% biodegradable, the netting, sewing or adhesive system that holds the biodegradable mulch fibres together must also be biodegradable.
    - The various products comprise:

**Table 8-12 Biodegradable rolled erosion control products**

Product	Comprises
Jute	<ul style="list-style-type: none"> <li>– Jute is a natural fibre that is made into a yarn, which is loosely woven into a biodegradable mesh. It is designed to be used in conjunction with vegetation with a life of approximately one year.</li> <li>– The material is supplied in rolled strips and needs to be secured to the soil with U-shaped staples or stakes in accordance with manufacturers' recommendations.</li> </ul>
Straw blanket	<ul style="list-style-type: none"> <li>• Straw blanket shall be machine-produced mats of straw with a lightweight biodegradable netting top layer. The straw shall be attached to the netting with biodegradable thread or glue strips. The straw blanket shall be of consistent thickness and the straw shall be evenly distributed over the entire area of the blanket.</li> <li>• Straw blanket shall be furnished in rolled strips a minimum of 2m wide, a minimum of 25m long and a minimum of 0.27 kg/m<sup>2</sup>.</li> <li>• Staples shall be made of 3.05mm steel wire and shall be U-shaped with 200mm legs and 50mm crown.</li> </ul>
Wood fibre blanket	<ul style="list-style-type: none"> <li>• Wood fibre blanket is composed of biodegradable fibre mulch with extruded plastic netting held together with adhesives. The material is designed to enhance revegetation.</li> <li>• The material is furnished in rolled strips which shall be secured to the ground with U-shaped staples or stakes in accordance with manufacturers' recommendations.</li> </ul>
Coconut fibre blanket	<ul style="list-style-type: none"> <li>• Coconut fibre blanket shall be machine-produced mats of 100% coconut fibre with biodegradable netting on the top and bottom. The coconut fibre shall be attached to the netting with biodegradable thread or glue strips. The coconut fibre blanket shall be of consistent thickness and shall be evenly distributed over the entire area of the blanket.</li> <li>• The coconut blankets shall be furnished in rolled strips a</li> </ul>

	<p>minimum of 2m wide, a minimum of 25m long and a minimum of 0.27 kg/m<sup>2</sup>.</p> <ul style="list-style-type: none"> <li>• Coconut fibre blankets shall be secured in place with wire staples.</li> <li>• Staples shall be made of 3.05mm steel wire and shall be U-shaped with 200mm legs and 50mm crown.</li> </ul>
Coconut fibre mesh	<ul style="list-style-type: none"> <li>• Coconut fibre mesh is a thin permeable membrane made from coconut or corn fibre that is spun into a yarn and woven into a biodegradable mat. It is designed to be used in conjunction with vegetation and typically has a life of several years.</li> <li>• The material is furnished in rolled strips which shall be secured to the soil with U-shaped staples or stakes in accordance with manufacturers' recommendations.</li> </ul>

– Non-biodegradable rolled erosion control products

- Non-biodegradable rolled erosion control products are typically comprised of polypropylene, polyethylene, nylon or other synthetic fibres. In some cases, a combination of biodegradable and synthetic fibres is used to construct the rolled erosion control products. Netting used to hold these fibres together is typically non-biodegradable as well.

**Jute mesh**



**Straw Blanket**



**Coconut Fibre Blanket**



**Table 8-13 Non-biodegradable erosion control products**

Product	Comprises
Plastic netting	<ul style="list-style-type: none"> <li>• Plastic netting is a lightweight biaxially-orientated netting designed for securing loose mulches like straw to soil surfaces to establish vegetation.</li> <li>• The netting is supplied in rolled strips and is photodegradable.</li> <li>• The netting shall be secured with U-shaped staples or stakes in accordance with manufacturers' recommendations.</li> </ul>
Plastic mesh	<ul style="list-style-type: none"> <li>• Plastic mesh is an open-weave geotextile that is composed of an extruded synthetic fibre woven into a mesh with an opening size of less than 50mm.</li> <li>• It is used with revegetation or may be used to secure loose fibre such as straw to the ground.</li> <li>• The netting is supplied in rolled strips and shall be secured with U-</li> </ul>

	shaped staples or stakes in accordance with manufacturers' recommendations.
Synthetic fibre with netting	<ul style="list-style-type: none"> <li>• This is a mat comprised of durable synthetic fibres treated to resist chemicals and ultraviolet light. The mat is a dense, three-dimensional mesh of synthetic fibres stitched between two polypropylene nets.</li> <li>• The mats are designed to be revegetated and provide a permanent composite system of soil, roots and geomatrix.</li> <li>• The netting is supplied in rolled strips and shall be secured with U-shaped staples or stakes in accordance with manufacturers' recommendations.</li> </ul>
Bonded synthetic fibres	<ul style="list-style-type: none"> <li>• Bonded synthetic fibres consist of a three-dimensional geomatrix nylon (or other synthetic) matting. Typically it has more than 90% open area which facilitates root growth.</li> <li>• It has a tough root reinforcing system that anchors vegetation and protects against hydraulic lift and shear forces created by high volume discharges.</li> <li>• It can be installed over prepared soil followed by seeding into the mat. Once vegetated it becomes an invisible composite system of soil, roots and geomatrix.</li> <li>• The netting is supplied in rolled strips and shall be secured with U-shaped staples or stakes in accordance with manufacturers' recommendations.</li> </ul>
Combination synthetic and biodegradable rolled erosion control products	<ul style="list-style-type: none"> <li>• These consist of biodegradable fibres such as wood fibre or coconut fibre with a heavy polypropylene net stitched to the top and a high-strength continuous filament geomatrix or net stitched to the bottom.</li> <li>• The material is designed to enhance revegetation.</li> <li>• The material is supplied in rolled strips and shall be secured with U-shaped staples or stakes in accordance with manufacturers' recommendations.</li> </ul>

**Enkamat used as erosion protection and medium for revegetation. Source: Maccaferri NZ Ltd**



- Geobinders
  - Geo-binders should be applied to surfaces as per the manufacturers instructions.

### 8.12.5 Key installation considerations

- Site preparation
  - Proper site preparation is essential to ensure complete contact of the blanket or matting with the soil.
  - Grade and shape the area of installation.
  - Remove all rocks, clods, vegetation or other obstructions so that the installed blankets or mats will have complete and direct contact with the soil.
  - Prepare seedbed by loosening 50mm to 75mm of topsoil.
- Seeding
  - Seed the area before blanket installation for erosion control and revegetation.
  - Seeding after mat installation is often specified for turf reinforcement application. When seeding prior to blanket installation, all check slots and other areas disturbed during installation must be re-seeded.
- Anchoring
  - U-shaped wire staples, metal geotextile stake pins or triangular wooden stakes can be used to anchor mats and blankets to the ground surface.
  - Staples shall be made of 3.05mm steel wire and shall be U-shaped with 200mm legs and 50mm crown.
  - Metal stake pins shall be 5mm diameter steel with a 40mm steel washer at the head of the pin.
  - Wire staples and metal stakes shall be driven flush to the soil surface.
  - All anchors shall be 150mm to 450mm long and have sufficient ground penetration to resist pull-out. Longer anchors may be required for loose soils.
- Installation on slopes
  - Installation shall be in accordance with the manufacturers' recommendations. In general, these will be as follows:
  - Begin at the top of the slope and anchor the blanket in a 150mm deep by 150mm wide trench. Backfill trench and compact earth firmly.
  - Unroll blanket downslope in the direction of the water flow.
  - Overlap the edges of adjacent parallel rolls by 50mm to 75mm and staple every 1m.
  - When blankets must be spliced, place blankets end over end (shingle style) with 150mm overlap. Staple through overlapped area, approximately 300mm apart.
  - Lay blankets loosely and maintain direct contact with the soil. Do not stretch.
  - Staple blankets sufficiently to anchor blanket and maintain contact with the soil. Staples should be placed down the centre and staggered with the staples placed along the edges.
  - Follow the manufacturers' recommendation for the spacing of the staples although the following staple densities generally apply as outlined in Table 8-14:

**Table 8-14 Staple density**

Slope	Minimum staple density
> 50%	2.0 staples/m <sup>2</sup>
50% to 33%	1.5 staples/m <sup>2</sup>
< 33%	1.0 staples/m <sup>2</sup>

- Installation in channels
  - Installation shall be in accordance with the manufacturers' recommendations. In general, these will be as follows:
  - Dig initial anchor trench 300mm deep by 150mm wide across the channel at the lower end of the project area.
  - Excavate intermittent check slots (150mm deep x 150mm wide) across channel at 8m to 10m intervals along the channel.
  - Cut longitudinal channel anchor slots (100mm deep by 100mm wide) along each side of the installation to bury edges of matting. Whenever possible extend matting 50mm to 75mm above the crest of the channel side slopes.
  - Beginning at the downstream end and in the centre of the channel, place the initial end of the first roll in the anchor trench and secure with fastening devices at 300mm intervals.
  - In the same manner, position adjacent rolls in anchor trench, overlapping the preceding roll a minimum of 75mm.
  - Secure these initial ends of mats with anchors at 300mm intervals, backfill and compact soil.
  - Unroll centre strip of matting upstream. Stop at next check slot or terminal anchor trench. Unroll adjacent mats upstream in similar fashion maintaining a 75mm overlap.
  - Fold and secure all rolls of matting into all traverse check slots. Lay mat in the bottom of the slot and then fold back against itself. Anchor through both layers of mat at 300mm intervals and then backfill and compact soil. Continue rolling all mat widths upstream to the next check slot or terminal anchor trench.
  - Lap spliced ends by a minimum of 300mm apart on 300mm intervals.
  - Place edges of outside mats in previously excavated longitudinal slots, anchor using prescribed staple pattern, backfill and compact soil.
  - Anchor, fill and compact upstream end of mat in a 300mm by 150mm terminal trench.
  - Secure mat to ground surface using U-shaped wire staples, geotextile pins or wooden stakes.
  - Seed and fill turf reinforcement matting with soil if specified.

### 8.12.6 Maintenance

Areas treated with temporary soil stabilisation shall be inspected daily and after each rainfall event. Areas treated with temporary soil stabilisation shall be maintained to provide appropriate erosion control and shall be reapplied or replaced on exposed soils when the area becomes exposed or exhibits visible erosion. The maintenance aspects to look for comprise:

- Lifting geotextile caused by vegetation growing up under the fabric.
- Rilling caused by water flowing beneath the geotextile.
- Torn geotextile, missing pins or other damage caused by high winds, machinery or vandalism.
- Any areas of geotextile damaged or dislodged in any way should be repaired or replaced. If required, erect a temporary barrier and/or signage fencing to restrict uncontrolled movement of equipment and vehicles onto treated areas.

### **8.12.7 Decommissioning**

When decommissioning geotextiles undertake the following:

- If geotextile is temporary, remove it and stabilise the area.
- If geotextile is permanent, ensure good stabilisation occurs and that it does not compromise the landscaping requirements.

## 8.13 Dust Control

### 8.13.1 Definition and purpose

Dust control is controlling dust movement on construction sites.

The purpose of dust control is to:

- Prevent or reduce the movement of dust from disturbed soil surfaces that may create health hazards, traffic safety problems and off-site damage.

Dust suppression using a water cart



### 8.13.2 Conditions where practice applies

The practice is applicable to areas subject to dust movement where on and off-site damage is likely to occur if dust is not controlled. Under certain conditions, some of the chemicals used for dust control may also be used for bare soil stabilisation in situations where the introduction of organic materials would be undesirable (e.g. road beds and structural fill).

### 8.13.3 Limitations

Dust control has the following limitations:

- The effectiveness of the practice depends on soil, temperature, humidity and wind velocity/direction.
- The availability of sufficient water during mid-summer when the supply is limited.

### 8.13.4 Key design criteria

Dust control should be considered early in the planning stages of any earthworks project. Forward planning and management to minimise dust problems provide the best options for control. If dust management is only addressed after it has become a problem on site, it is very difficult to bring under effective control until the site has been stabilised.

The following methods for dust control apply:

- Water Sprinkling
  - This is the most commonly used dust control practice. Water is normally applied for dust suppression via a water cart or by sprinkler system and either system requires a minimum amount of water to achieve effective dust control.
  - Generally the minimum amount of water required to control potential dust problems is 5mm/day. This should be repeated so that the ground remains moist.
  - With specific soils (e.g. loess and/or alluvials in Canterbury), water will not be an effective control and chemical adhesives or other measures will be required.
  - Water carts can carry from 3,000L to 10,000L, however their use is limited by the ability of the vehicle to access the areas that require wetting.



- The use of a sprinkler system may also be used where there are large areas open or where the terrain is too steep for water carts. Sprinkler systems are commonly used where irrigation may be useful to establish vegetation following earthworks completion.

**Dust suppression using adhesives**



- A reliable source of water is required and can be sourced from sediment retention ponds or authorised water takes (bore, stream, lake or municipal water supply). Approval to take from these supplies may be required from the local authority.

- Adhesives

- Confirm with your local authority that the above products are acceptable for use within their jurisdiction.
- Use on mineral soils only. These are generally synthetic materials that are applied to the soil surface to act as binding agents.
- Traffic should be kept off these areas once they have been treated.
- The following table (Table 8-15) may be used for general guidance on application rates:

**Table 8-15 Application rates for adhesives**

Type of emulsion	Water dilution	Type of nozzle	Application rate
Latex emulsion	12.5:1	Fine spray	2200 litres/ha
Resin-in-water emulsion	4:1	Fine spray	2800 litres/ha
Acrylic emulsion (non-traffic)	7:1	Coarse spray	4200 litres/ha
Acrylic emulsion (traffic)	3.5:1	Coarse spray	3275 litres/ha

-

- Barriers

- Place barriers such as solid board fences, fences with dust suppression jets, hay bales etc. at right angles to the prevailing air currents.
- These should be placed at intervals of approximately 10 times their height.

**Use of a fine water mist on top of barrier fence to contain dust movement**

- Mulches and Vegetation

- Refer to subsection 8.8 and 8.10 for the specifications on mulching and grass establishment.

- Management Practices

- A Dust Management Plan may be a requirement for resource consent in some regions. In general, the plan should comprise of the following aspects:





- 
- Soil characteristics of the site and whether the timing/staging of operations will assist in dust reduction;
  - Wind direction;
  - Methods used to reduce vehicle speeds;
  - Operational considerations – staging of area, progressive stabilisation etc.;
  - Types of measures used – water, vegetation and/or chemical suppressants;
  - Contingency measures in place for severe wind problems (e.g. ceasing works if the primary method of control is not effective for the wind conditions);
  - Signage and indications of contact numbers for dust complaints.

### **8.13.5 Maintenance**

The following maintenance requirements shall be considered:

- Periodically inspect areas that have been protected to ensure adequate coverage.
- Dust monitoring should become part of your general site monitoring and may also be required as a condition of consent for the project.

### **8.13.6 Decommissioning**

Prior to decommissioning dust controls ensure that good site stabilisation occurs.

## 9. Sediment control practices

It is recognised that the treatment of suspended solids and turbidity of water through a sediment control device such as sediment retention ponds and decanting earth bunds are not solely dependent on the volume of the device. It is important that the design features of the devices outlined in this section are constructed as per this standard to ensure optimum treatment efficiencies.

Soil particle size, catchment size and characteristics and the hydrology of catchments are critical factors that can influence device sizing. These factors are extremely variable throughout New Zealand and need to be taken into account when developing an ESCP for your project.

Sizing of devices solely based on soil particle size would be complex and would need to be undertaken on a project by project basis. Figure 9-1 provides flowchart for sizing sediment retention practice storages.

In this regard the sizing approach for sediment control devices recommended in Section 6 should be used for both decanting earth bunds and sediment retention ponds.

If a lesser volume is proposed by the Designer, a detailed soil particle analysis should be provided for justification and approval sought.

**Figure 9-1 Conceptual Flow Chart for Sizing Storage Practices**

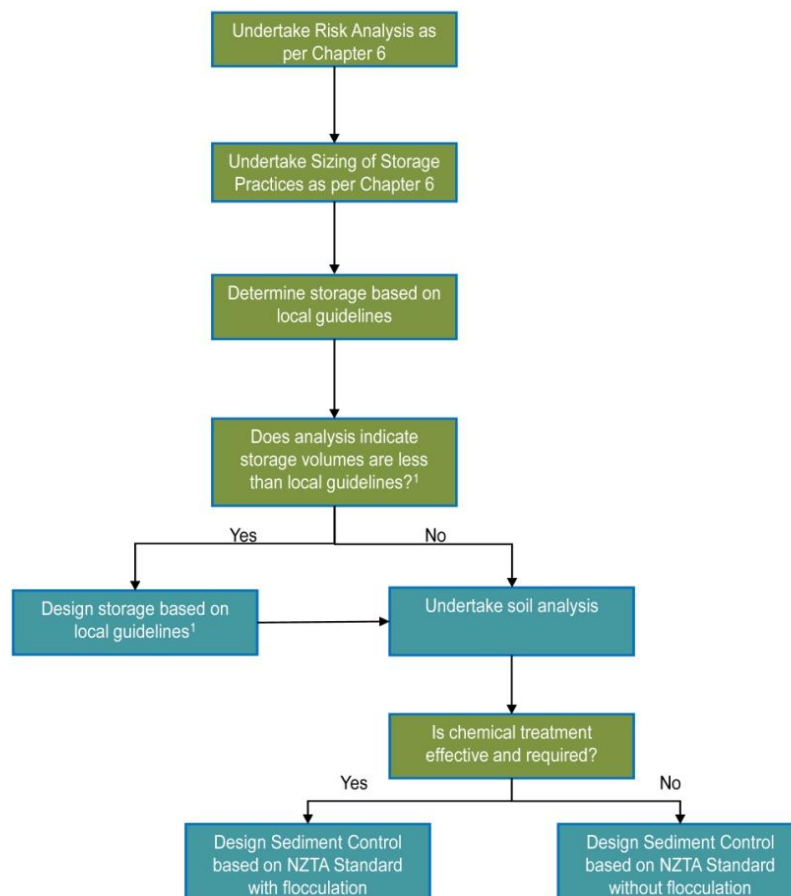

<sup>1</sup> The designer should check any local Erosion and Sediment Control guidelines, consent, designation and outline plan of works conditions, National Environmental Standards or any other approval processes that may affect sizing of storage practices

## 9.1 Sediment retention pond

### 9.1.1 Definition and purpose

A sediment retention pond is a temporary pond formed by excavation into natural ground or by the construction of an embankment, and incorporating a device to dewater the pond at a rate that will allow the majority of suspended sediment to settle out.

The purpose of a sediment retention pond is

- To treat sediment laden runoff and reduce the volume of sediment leaving a site, thus protecting downstream environments from excessive sedimentation, water quality degradation and impacts of increased flow on stream channels.

Sediment retention ponds are appropriate where treatment of sediment laden runoff is necessary, and are generally considered the appropriate control measure for exposed catchments of more than 0.3 ha. It is vital that the sediment retention pond is maintained until the disturbed area is fully protected against erosion by permanent stabilisation, as defined in Section 9.1 to 9.5 of this Standard.

The location of the sediment retention pond needs to be carefully considered in terms of the overall project. Initial considerations to be accounted for are:

- The available room for construction and maintenance of the pond;
- The final location of any permanent stormwater retention facilities that may be constructed at a later stage. In this respect, there may be opportunity to excavate the permanent stormwater pond and be used as a sediment retention pond during the intervening earthworks stage;
- Whether drainage works can be routed to the sediment retention pond until such time as the site is fully stabilised. This eliminates the problem of installing and maintaining stormwater inlet protection throughout the latter stages of a development.

The general design approach is to create an impoundment of sufficient volume to capture a significant proportion of the design runoff event, and to provide quiescent (stilling) conditions which promote the settling of suspended sediment. To achieve these conditions will require the sediment retention pond to be constructed in strict accordance with the design criteria outlined in this section.

### 9.1.2 Conditions where practice applies

The sediment retention pond design is such that very large runoff events will receive at least partial treatment and smaller runoff events will receive a high level of treatment. To achieve this, the energy of the inlet water needs to be low to minimise re-suspension of sediment and the decant rate of the outlet also needs to be low to minimise water flow through rates and to allow sufficient detention time for the suspended sediment to settle out (Refer Figure 9-1). Specific design criteria is discussed below, but can be summarised as the following.

**Sediment Retention Pond**



- Generally use sediment retention ponds for bare areas of bulk earthworks of 0.3 ha or greater.
- Restrict catchment areas to less than 5ha per sediment retention pond. This limits the length of overland flow paths and reduces maintenance problems.
- Locate sediment retention ponds so as to provide a convenient collection point for sediment laden flows from the catchment area. This will require strategic use of cut-offs, runoff diversion channels and contour drains.
- Provide maintenance access to allow for removing sediment from the pond.
- Wherever possible, locate sediment retention ponds to allow the primary outlet and spillway to discharge over undisturbed, well vegetated ground.
- Keep the sediment retention ponds life to less than two years. If a longer term is required then further measures to ensure stability and effectiveness are likely to be needed.
- Do not locate sediment retention ponds within watercourses.

**Figure 9-1 Schematic of a Sediment Retention Pond**

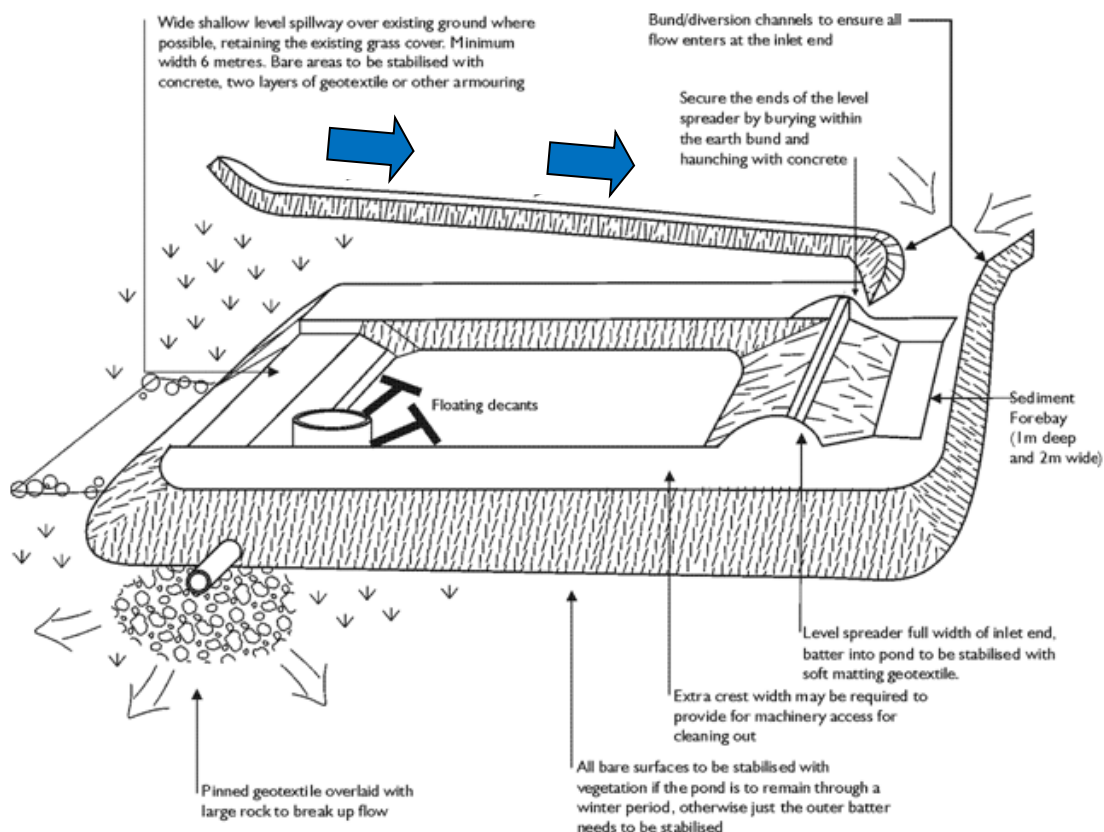

### 9.1.3 Limitations

Sediment retention ponds have the following limitations:

- Sediment retention ponds can occupy significant space (footprint and associated side slopes). This needs to be recognised when designing an ESCP and applying for designations.

- The outlet pipe through the embankment is the weakest point of a pond. Antiseep or filter collars should be installed, and earth compacted to engineering standards. In a number of cases (e.g. steep slopes and low strength soils) specific geotechnical design will be required.
- Embankment and spillway stability are generally the weak points in sediment retention pond construction. Correct compaction particularly around emergency spillways, discharge pipes and antiseep or filter collars, will keep the system robust.
- Maximum catchment of 5ha without prior approval from NZTA and the local authority.
- Decant systems can become blocked resulting in overtopping and poorly treated runoff discharging to the receiving environment. Pulley systems attached to the decants can assist, however maintenance is paramount to ensure that this does not occur.
- The pond features need to be carefully reviewed once constructed to ensure the pond operates as designed.

## 9.1.4 Key design criteria

### 9.1.4.1 Size of the pond

Calculate the volume of the sediment retention pond using the depth measured from the base of the sediment retention pond to the top of the primary spillway, as outlined in Figure 9-3.

- On sites that are particularly steep or have sensitive downstream environments, a greater sediment retention pond volume may be required as indicated in the hydrologic design approach.
- Clearly show the sediment retention pond dimensions necessary to obtain the required volume, as detailed above, on the site's ESCP.

### 9.1.4.2 Dead storage (permanent storage)

- Dead storage is the component of impoundment volume that does not decant and remains in the sediment retention pond. It is important for dissipating the energy of sediment laden inflows.
- Ensure dead storage is 30% of the total sediment retention pond storage by positioning the lowest decant 0.4 – 0.8m above the invert of the sediment retention pond.
- The approved decant design detailed in this standard allows the lower decant arm to be raised as sediment deposition increases, thereby maintaining the percentage volume of dead storage.

### 9.1.4.3 Live storage (decant storage)

- Live storage is the volume between the lowest decant outlet level and the crest of the sediment retention pond primary spillway.
- Ensure that the live storage volume capacity is 70% of the total sediment retention pond storage.
- The decant design allows the decant system to be raised as sediment deposition increases, thereby maintaining the percentage volume of live storage.

#### 9.1.4.4 Decanting/outlet dewatering device

- Dewater the sediment retention pond so as to remove the water within the upper water column without removing any of the settled sediment, and without removing any appreciable quantities of floating debris.
- Various dewatering devices are available, however the use of a floating T-bar dewatering device is preferred, which allows for the decanting of the cleaner surface water from the top of the water column.
- The recommended decant rate from a sediment retention pond is provided through 10 mm diameter holes drilled in rows along a two metre long decant arm. The number of holes is determined by the need to ensure appropriate detention to maximise sediment deposition. This will vary with soil type, as shown in Table 9-1. The maximum number of holes per decant is 200.

**Table 9-1 Decant Design (from Erosion and Sediment Control Guideline, 2007, Environment Canterbury)**

Soil Type	Holes/hectare	Hectares/decant
Flat gravel	27	7.4
Flat - moderately sloping silt loam (0-20%)	72	2.8
Steep silt loam (>20%)	90	2.2
Flat Clay (<20%)	72	2.5
Steep clay (>20%)	72	2.0

- Drill the right number of decant holes in relation to the size of the catchment. For instance, a 2.5 ha catchment on a silt loam soil with a slope <20% will require 180 holes (72x2.5).
- A standard T-bar design is detailed in Figure 9-2 for various sized catchments.
- Single T-bar decants must be able to operate through the full live storage depth of the sediment retention pond.
- The decant design in this standard operates through a maximum live storage range of 1.5m.

**Figure 9-2  
Sediment Retention Pond – Decant Detail**

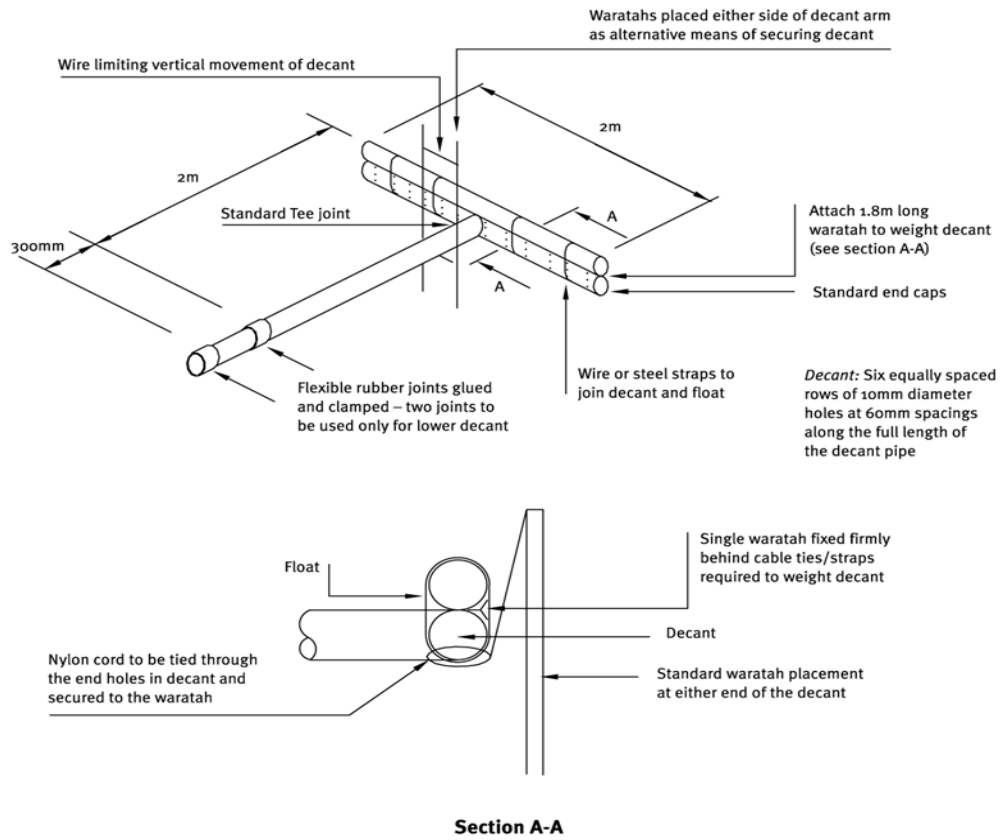

- 
-

For catchments of less than 1.5ha, seal off the appropriate number of holes to achieve a 3 litres/ second/hectare discharge rate. A schematic of a sediment retention pond for catchment areas less than 1.5ha is shown in Figure 9-3.

**Figure 9-3  
Sediment Retention Pond for One Decant**

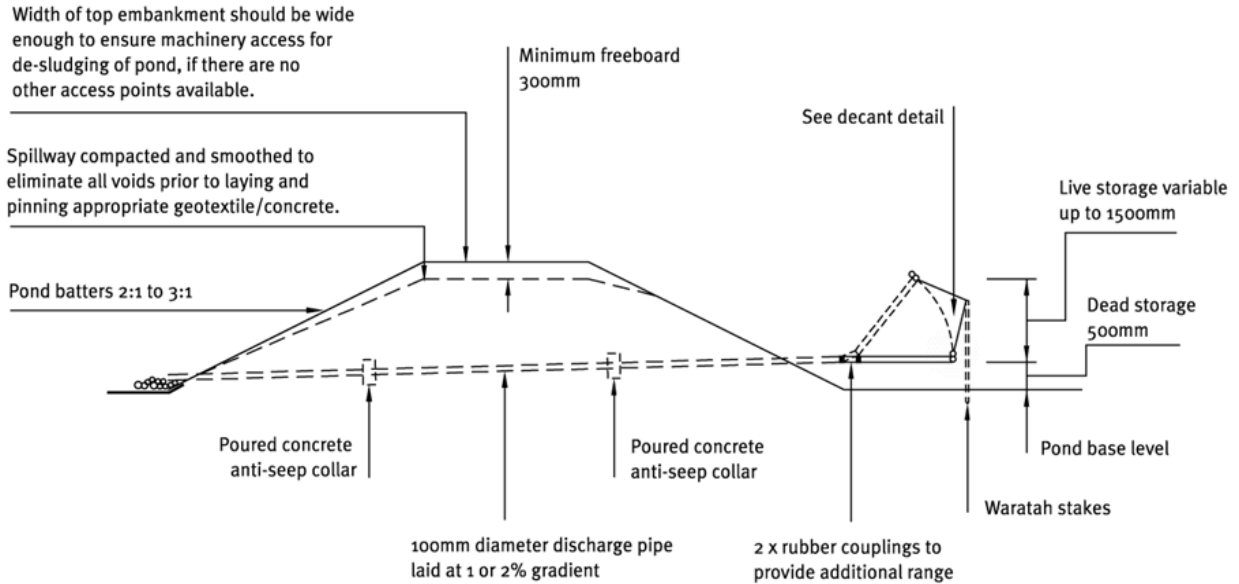

**Cross Section**

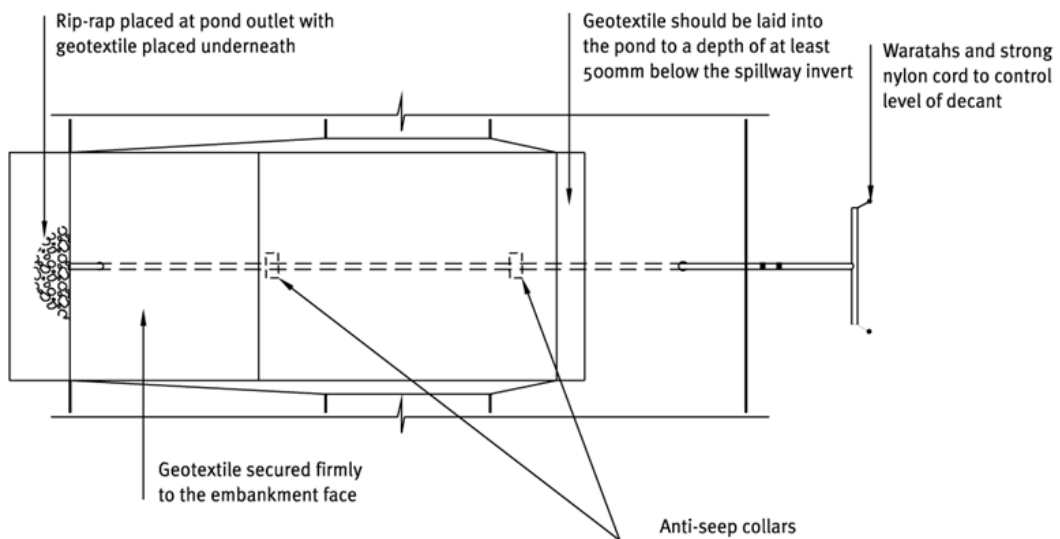

**Plan**



- If two decant systems are required (Figure 9-4), ensure the lower T-bar decant operates through the full live storage depth of the sediment retention pond. The upper T-bar decant is to operate through the upper 50% of the live storage depth only.

**Figure 9-4**  
**Sediment Retention Pond for Two Decants**

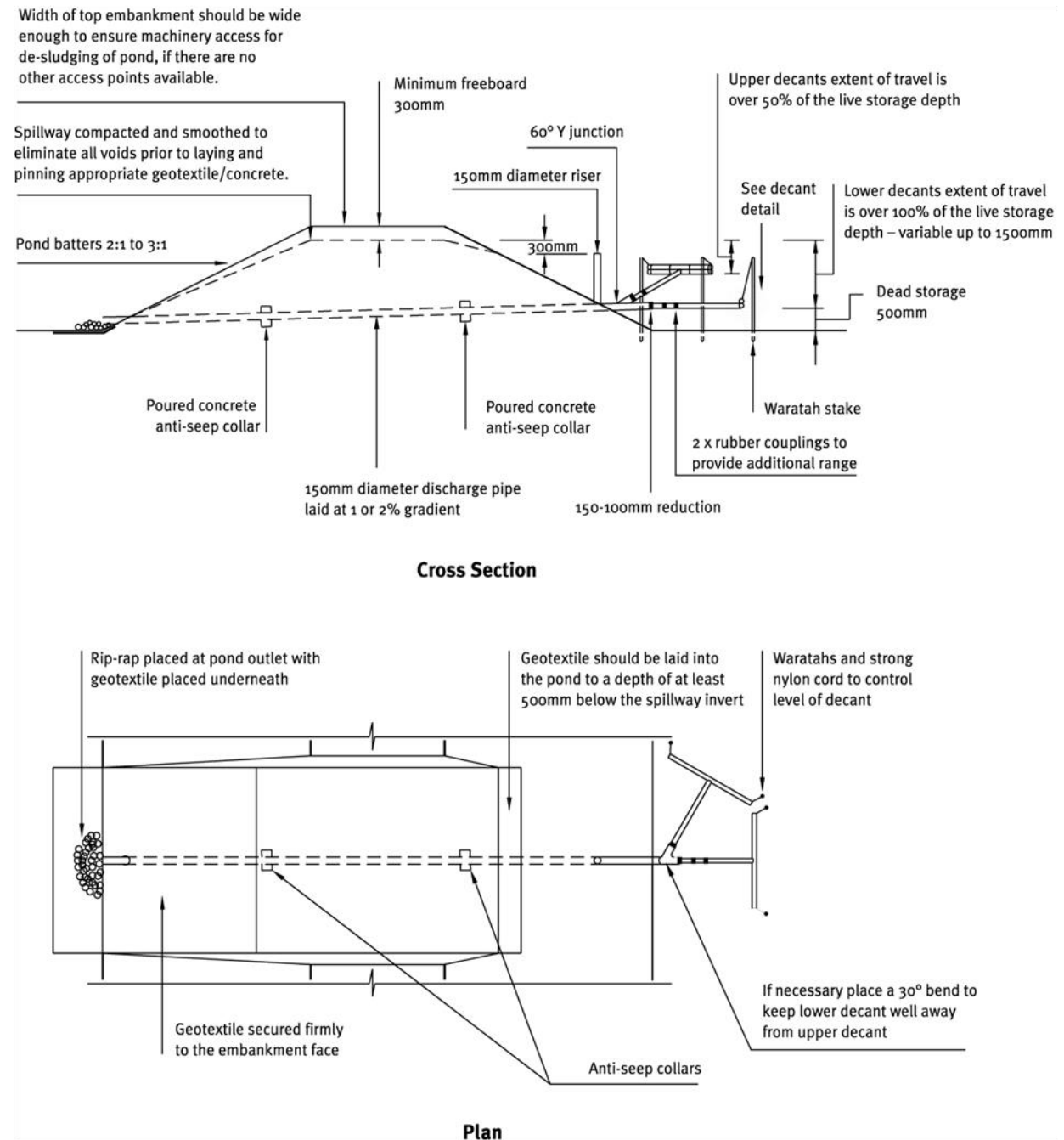

- If three decant systems are to be used, then the lower T-bar decant operates through the full live storage depth and the second T-bar decant through the upper two thirds of live storage depth of the sediment retention pond. The upper T-bar decant operates through the upper one third of live storage depth of the sediment retention pond as detailed in Figure 9-5.

**Figure 9-5  
Sediment Retention Pond for Three Decants**

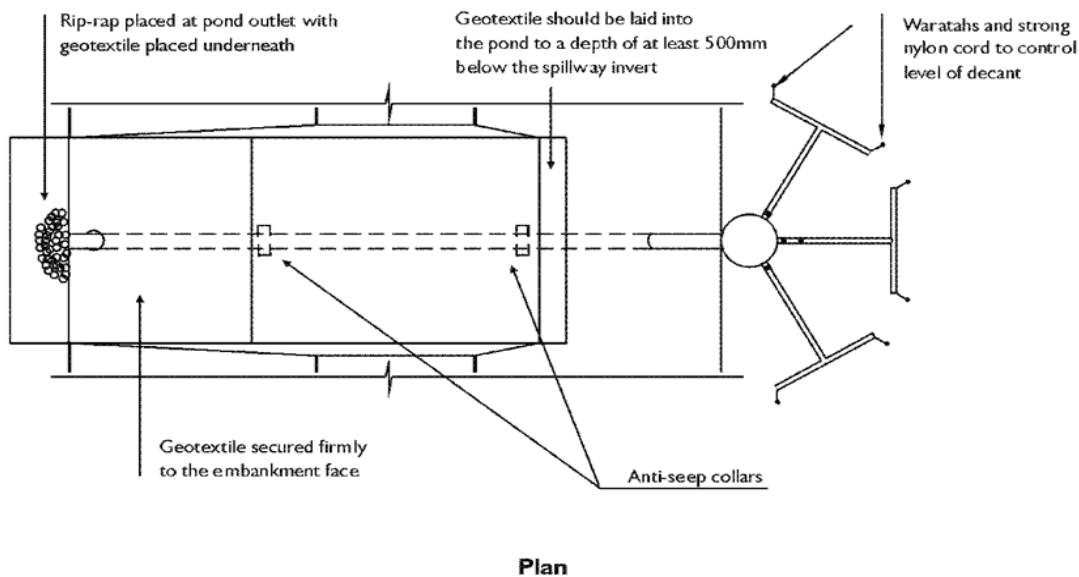
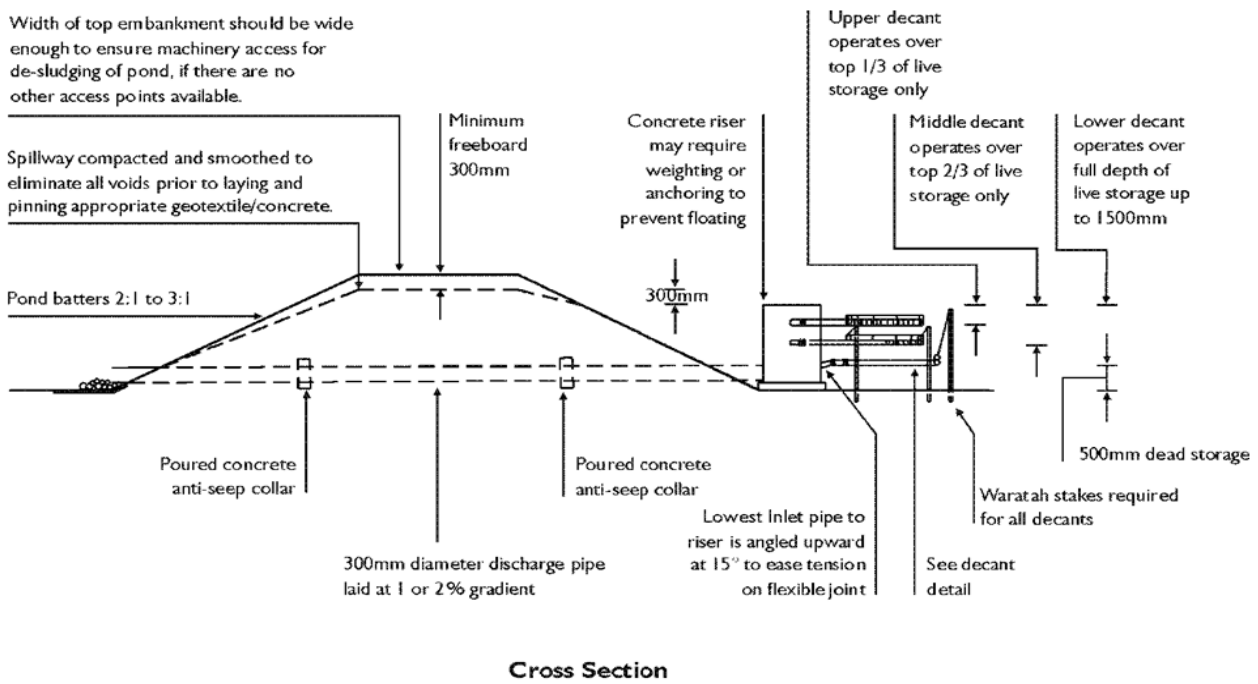

- Ensure that the T-bar decant float is securely fastened with steel strapping directly on top of the decant arm and weight it to keep the decant arm submerged just below the surface through all stages of the decant cycle. This will also minimise the potential for blockage of the decant holes by floating debris. The most successful method found to date is to weight the decant arm by strapping a 1.8m long waratah between the float and decant (approximately 4kg of weight).
- Position the T-bar decant at the correct height by tying 5mm nylon cord through decant holes at either end of the decant arm and fastening it to waratahs driven in on either side of the decant.

- Lay the discharge pipe at a 1 - 2% gradient, compact the fill material around it using a machine compactor and incorporate anti-seep / filters collars with the following criteria:
  - Anti-seep collars
    - Install collars around the pipe to increase the seepage length along the pipe with a spacing of approximately 10m;
    - The vertical projection of each collar is 1m; ensure all anti seep collars and their connections are watertight.
  - Filter collars
    - The filter collar, as shown in Figure 9-6, must be positioned along the pipe ensuring they start just after half way through the dam where  $h = 2/3 H$ , where H is the embankment height.
    - The filter collar should be 1m x 1m x 1m and allow for sufficient compaction around the pipe. Specific design is required if the pipe diameter is greater than 200mm.
    - The filter material must be medium to coarse sand, e.g. a  $D_{15} = 0.7\text{mm}$  is anticipated to provide a good filter. Seek professional advice if there is any doubt about the compatibility of filter materials with the local ground conditions or embankment fill.
    - The filter sands must be compacted sufficiently wet to optimize compaction and avoid saturation collapse.
    - The filter drain must continue to the outlet to allow for drainage from the filter collar to the downstream toe.
    - The outlet must allow for seepage from the filter drain and be stabilized against erosion and dissipate energy, e.g. rock fill riprap at the outlet with a heavy duty geotextile filter fabric.

**Figure 9-6**  
**Filter Collar Schematic Detail**

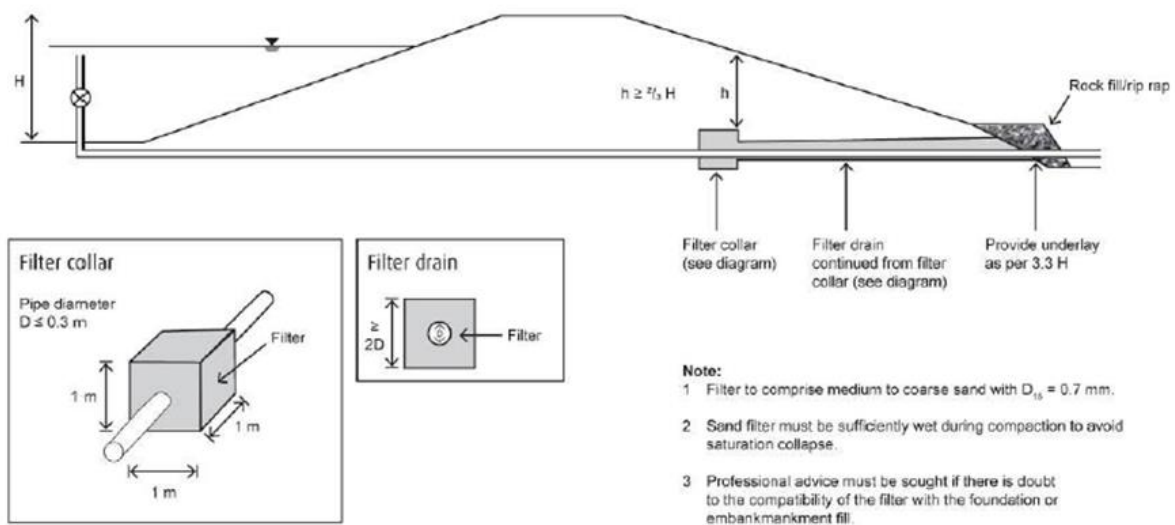

○

Use a flexible thick rubber coupling to provide a connection between the decant arm and the primary spillway or discharge pipe. To provide sufficient flexibility (such as is required for the lower decant arm) install two couplings. Fasten the flexible coupling using strap clamps, glue and screws.

- Where a concrete riser decant system is utilised, ensure the lower decant connection is positioned on an angle upwards from the horizontal so as to split the operational angle that the decant works through. This will reduce the deformation force on the coupling used.
- Rope and pulley systems installed on the decants provide benefits in terms of water quality.

**Decants on Rope and Pulley System**



#### 9.1.4.5 Shape of the pond

- Ensure the length to width ratio of the sediment retention pond is no less than 3:1 and no greater than 5:1. The length of the sediment retention pond is measured as the distance between the inlet and the outlet (decant system).
- Maximise the distance between the inlet and the outlet (including the emergency spillway) to reduce the risk of short circuiting and to promote quiescent conditions. If this cannot be achieved by correctly positioning the inlet and outlets, install baffles to achieve the appropriate length to width ratio design.
- Ensure that the sediment retention pond has a level invert as described below to promote the even and gradual dissipation of the heavier inflow water across the full area of the sediment retention pond.

#### 9.1.4.6 Level spreader

- Incorporate a level spreader into the inlet design to spread inflow, reduce velocities and maximise the full size of the pond.
- The essential design feature is to ensure the level spreader is level, non-erodible and spans the full width of the sediment retention pond (Figure 9-7).
- A level spreader consists of a 150mm x 50mm straight timber plank laid on its edge, levelled and fastened into place with concrete, bolted through waratah or other fasteners. Timber stakes are not recommended as they usually move.
- Position the top of the level spreader weir 100 – 200mm above the invert

**Level Spreader and Forebay**



of the emergency spillway.

- Combine the level spreader with a well compacted and smoothed inlet batter (no steeper than a 3:1 gradient). Lay geotextile fabric in the level spreader trench and down the inlet batter to the dead storage level. To ensure flows do not outflank the level spreader concrete haunching the ends will assist.

#### 9.1.4.7 Forebay

- Construct a forebay with a volume equal to 10% of the design pond volume.
- The forebay should extend the full width of the pond and be a maximum of 1m in depth.
- The forebay is upstream of the level spreader.
- Access is to be maintained to the forebay at all times to allow removal of accumulated sediment.

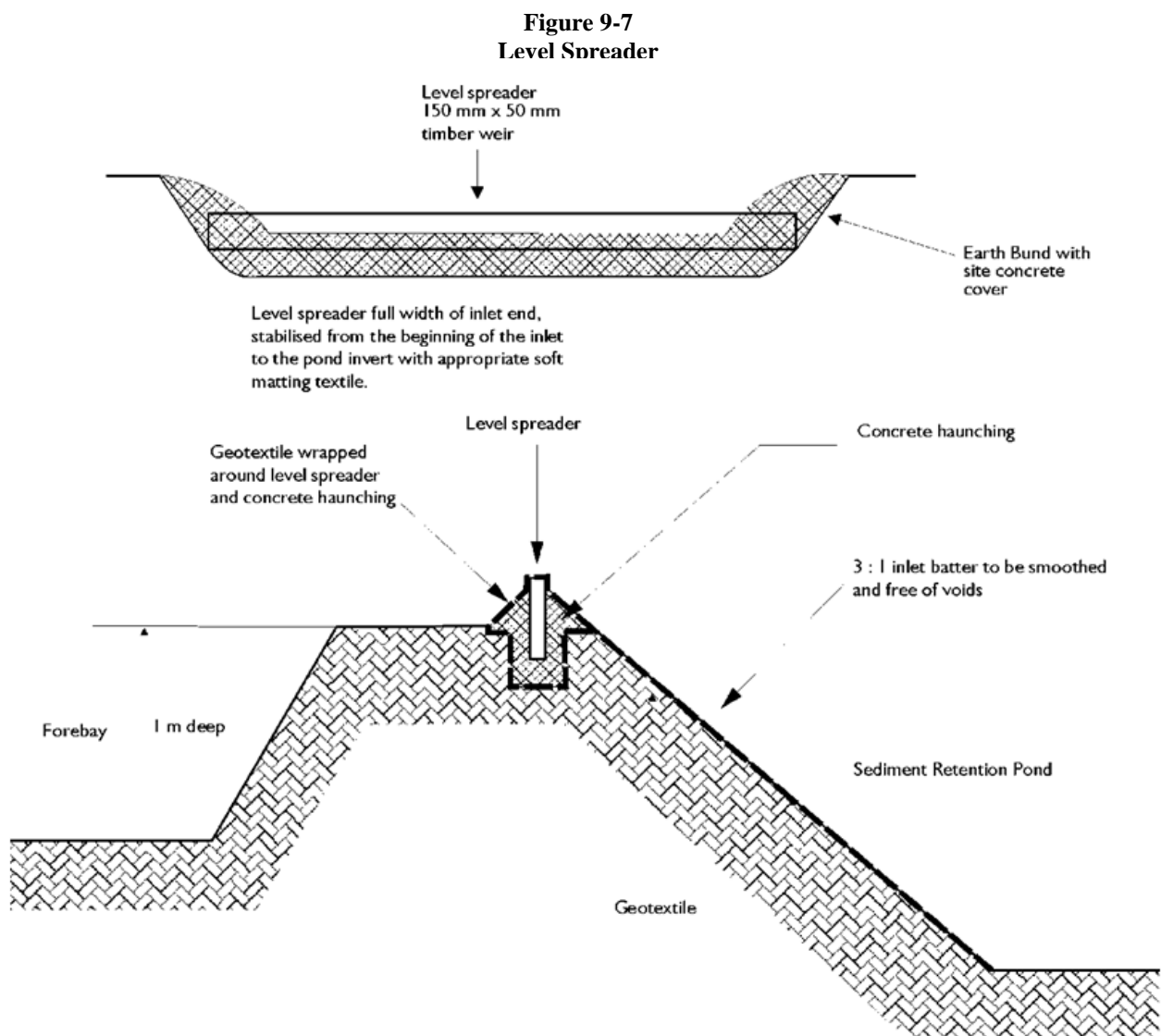

#### 9.1.4.8 Baffles

- Incorporate baffles in the sediment retention pond design where the recommended pond shape cannot be achieved. Extend baffles the full depth of the sediment retention pond and place them to maximise dissipation of flow energy.
- Generally, baffles are in the form of a wing to direct inflows away from the outlet and maximise the stilling zone and flow path. A series of compartments within the pond can be used to achieve this, although care must be taken to avoid creating in-pond currents and resuspension of light particulates.
- Baffles may be constructed from various materials ranging from solid shutter boards to braced geotextile curtains.

#### 9.1.4.9 Depth of pond

- Sediment retention pond depths may be 1 – 2m deep, but no deeper than 2m. Deeper ponds are more likely to cause short circuiting problems during larger storm events, require specifically designed floating decant systems and could represent a safety hazard.
- The decant design in this standard operates through a maximum live storage range of 1.5m.

#### 9.1.4.10 Embankment

- Before building a sediment retention pond, install sediment controls such as Silt Fences below the construction area and maintain them to a functional standard until the sediment retention pond batters are fully stabilised in accordance with the practices outlined in Section 8.3.
- Thoroughly compact the sediment retention pond embankment, with material laid in 150mm layers and compacted to engineering standards. In a number of instances (e.g. steep slopes and/or low strength soils) specific geotechnical design and certification will be required.
- Where possible install the discharge pipes through the embankment as the embankment is being constructed.
- Fully stabilise the external batter face, by vegetative or other means, immediately after construction.
- Ensure all bare areas associated with the sediment retention pond (including internal batters) are stabilised with vegetation if the sediment retention pond is to remain in place over winter.

#### 9.1.4.11 Primary spillway

- For larger catchments (greater than 1.5ha) the sediment retention pond requires a piped primary spillway (refer Figures 9-4 and 9-5).
- For catchments up to 1.5ha, decant flows can be piped using the same diameter piping as the decant system (100mm PVC smooth bore) directly through the sediment retention pond wall to discharge beyond the toe of the sediment retention pond wall.
- For contributing catchments between 1.5 and 3ha in area, use a discharge and primary spillway pipe diameter of 150mm.

- Where contributing catchments are 3ha or greater and/or the long term stability of the sediment retention pond emergency spillway is questionable (for example, built in fill) then consideration should be given to incorporating a concrete manhole riser and larger diameter pipe outlet as a primary spillway sufficient to accommodate the 5% AEP rainfall event.
- If the sediment retention pond is to operate over the winter and the contributing catchment is fully stabilised, disconnect the T-bar decant to reduce the frequency of emergency spillway activation and consequent erosion.
- Where a primary spillway upstand riser is used, place the top of the riser a minimum 600mm lower than the top of the sediment retention pond embankment and a minimum 300mm lower than the emergency spillway crest. Ensure the riser and the discharge pipe connections are all completely watertight.
- Where possible, install the piping through the embankment as the embankment is being constructed.

#### 9.1.4.12 Emergency spillway

- An emergency spillway is essential for all sediment retention ponds.
- Emergency spillways must be capable of accommodating the 1% AEP event without eroding. If the spillway is vegetated only, velocities during the 1% event must be less than 1.5m/s. The design storm event shall use the methodology outlined in Section 6 of this Standard.
- The outer emergency spillway crest and batter requires a very high standard of stabilisation with the fill material of the spillway batter well compacted.
- Construct the emergency spillway as a stabilised trapezoidal cross section with a minimum bottom width of 6m or the width of the pond floor, whichever is the greater.
- When utilising geotextile for emergency spillway stabilisation purposes, the batter face must be smooth and all voids eliminated to prevent puncturing of the fabric.
- If geotextile is used, a soft needle punched geotextile is laid first and then covered with a strong woven low permeability geotextile. Ensure the geotextile is pinned at 0.5m centres over the full area of the emergency spillway.
- Where possible, construct emergency spillways in well vegetated, undisturbed ground (not fill) and discharge over long grass.
- If the emergency spillway is constructed on bare soil, provide complete erosion protection by means such as grouted riprap, asphalt, erosion matting/ geotextile or concrete.
- Construct the emergency spillway with a minimum of 300mm freeboard height above the primary spillway.

#### 9.1.5 Construction specifications

Sediment retention ponds have the following construction specifications:

- Construct a silt fence across the downslope end of the proposed works.
- Clear areas under proposed fills of topsoil or other unsuitable material down to competent material. Large fill embankments may need to be keyed in.

- Use only approved fill.
- Place and compact fill in layers as per the engineer's specifications. In a number of instances (e.g. steep slopes and/or low strength soils) specific geotechnical design and certification will be required.
- Do not place pervious materials such as sand or gravel within the fill material.
- Construct fill embankments approximately 10% higher than the design height to allow for settlement of the material. Excavate through the embankment after completed to install the appropriate pipe work and antiseep/ filter collars. Compact around these appropriately.
- Construct the emergency spillway.
- Install and stabilise the level spreader.
- Securely attach the decant system to the horizontal pipework. Make all connections watertight. Place any manhole riser on a firm foundation of concrete (preferred) or impervious compacted soil.
- Do not place pervious material such as sand or scoria around the discharge pipe or the antiseep collars/ filters.
- Protect inlet and outlet with fabric.
- Install baffles if length to width ratio is less than 3:1.
- Provide an all-weather access track for maintenance.
- Check sediment retention pond freeboard and spillway elevations for differential settlement and rectify as necessary.
- Stabilise both internal and external batters with vegetation and the emergency spillway in accordance with the site's approved ESCP.
- Undertake an As Built assessment at the completion of construction to check against the design. If there are any discrepancies rectify immediately.

**Construction of a Sediment Retention Pond**



### 9.1.6 Maintenance

Sediment retention ponds have the following maintenance requirements:

- Clean out sediment retention ponds before the volume of accumulated sediment reaches 20% of the total sediment retention pond volume. To assist in gauging sediment loads, clearly mark the 20% volume height on the decant riser.
- Clean out sediment retention ponds with high capacity sludge pumps, or with excavators (long reach excavators if needed) loading onto sealed tip trucks or to a secure area.



- Clean out the forebay after each runoff event if there is any evidence of sediment deposition.
- The ESCP should identify disposal locations for the sediment removed from the sediment retention pond. Deposit the sediment in such a location so that it does not lead to a direct discharge to receiving environments. Stabilise all disposal sites as required and approved in the site's ESCP.
- Inspect sediment retention ponds every day and before every forecasted rainfall event.
- Inspect for correct operation after every runoff event.
- Immediately repair any damage to sediment retention ponds caused by erosion or construction equipment.

### **9.1.7 Decommissioning**

In decommissioning sediment retention ponds consider the following:

- Install a silt fence or other device below the sediment retention pond
- Dewater pond (refer 8.6)
- Remove and correctly dispose all accumulated sediment.
- Remove fabric, concrete, pipe and other construction materials.
- Backfill the pond and compact soil, re-grade as required.
- Stabilise all exposed surfaces.

### **9.1.8 Safety**

Sediment retention ponds are attractive to children and can become safety hazards if not appropriately fenced and if safety rules are not followed. Low gradient pond batters provide an additional safety measure. Check the safety requirements of the local authority and the Ministry of Business, Innovation and Employment.

### **9.1.9 Chemical treatment**

If chemical treatment of the sediment retention pond is required, consider the following:

- Some chemicals can be used successfully to promote flocculation (clumping together) of suspended solids in the Sediment Retention Pond to increase the particle mass and speed the rate of settling (refer Section 9.6).
- Chemical dosing systems are likely to be required where the design sediment retention pond volume cannot be achieved because of site constraints and/or where a high level of treatment is required because of the sensitivity of the receiving environment. Chemical treatment is also more likely to be required where the clay component is high or where the cumulative effects of sediment discharge are significant.

## 9.2 Silt fences

### 9.2.1 Definition and purpose

A silt fence is a temporary barrier of woven geotextile fabric that is used to capture predominantly coarse sediments carried in sheet flow. Silt fences temporarily impound sediment laden runoff, reducing velocities and allowing sediment to settle out of the water.

The purpose of a silt fence is to detain flows from runoff so that deposition of transported sediment can occur through settlement and some filtering.



Silt Fence installed on edge of works

### 9.2.2 Conditions where practice applies

Silt fences apply when:

- Intercepting sheet flow.
- On low gradient sites or for confined areas where the contributing catchment is small, such as short steep batter fills and around watercourses.
- To delineate the limit of disturbance on an earthworks site such as riparian areas or bush reserves.
- To store runoff behind the silt fence without damaging the fence or the submerged area behind the fence.
- Do not install silt fences across watercourses or in areas of concentrated flows.

### 9.2.3 Limitations

Silt fences have the following limitations:

- Silt fences do not capture many soil particles finer than 0.02mm in diameter (for example fine silts and clays) due to the short detention time of water behind the silt fence and relatively large pore size of most fabrics.
- The pores in the silt fence fabric become clogged relatively quickly with fine textured sediments, which result in the fabric becoming impermeable. As a result additional reinforcing (such as chain link fence – super silt fence) might be required.
- Relative to other measures they can be high cost.
- Only used for sheet flow not concentrated flow. Do not use silt fences as checks dams in channels (to reduce velocities) or place them where they will intercept concentrated flow.
- Silt fences should be used a part of a treatment train approach.

## 9.2.4 Key design criteria

Silt fences shall be designed following the criteria below:

- Ensure silt fence height is 600mm above ground level.
- Place supporting posts/waratahs for silt fences no more than 2m apart unless additional support is provided by tensioned wire (2.5mm HT) along the top of the silt fence.
- Where a strong woven fabric is used in conjunction with a wire support, the distance between posts can be extended up to 4m. Double the silt fence fabric over and fasten to the wire and posts with wire ties, hog rings or cloth fastening clips at 150mm spacings. Ensure supporting posts/waratahs are embedded a minimum of 400 mm into the ground.
- Always install silt fences along the contour. Where this is not possible or where there are long sections of silt fence, install short silt fence returns projecting upslope from the silt fence to minimise concentration of flows. Silt fence returns are a minimum 2 m in length, can incorporate a tie back and are generally constructed by continuing the silt fence around the return and doubling back, eliminating joins.
- Join lengths of silt fence by doubling over fabric ends around a wooden post or batten or by stapling the fabric ends to a batten and butting the two battens together as shown in Figure 9-8.
- Maximum slope lengths, spacing of returns and angles for silt fences are shown in Table 9-2.
- Install silt fence wings at either end of the silt fence projecting upslope to a sufficient height to prevent outflanking.
- Where impounded flow may overtop the silt fence, crossing natural depressions or low points, make provision for a riprap splash pad or other outlet protection device.
- Use of silt fences in catchments of more than 0.5ha requires careful consideration of specific site measures, and other control measures maybe better, such as super silt fence.

**Table 9-2 Silt fence design criteria**

Slope steepness %	Slope length (m) (Maximum)	Spacing of returns (m)	Silt fence length (m) (Maximum)
Flatter than 2%	Unlimited	N/A	Unlimited
2 – 10%	40	60	300
10 – 20%	30	50	230
20 – 33%	20	40	150
33 – 50%	15	30	75
> 50%	6	20	40

- Where water may pond regularly behind the silt fence, provide extra support for the silt fence with tie backs from the silt fence to a central stable point on the upward side. Extra support can also be provided by stringing wire between support stakes and connecting the filter fabric to this wire.
- The fabric cloth must meet the following requirements for Geotextile fabric:

- Tension strength: 0.345 pa (minimum)
- Tensile modulus: 0.140 pa (minimum)
- Apparent opening size 100 mm

## 9.2.5 Construction

When constructing a silt fence, apply the following:

- Use silt fence material appropriate to the site conditions and in accordance with the manufacturer's specifications.
- The fabric cloth must meet the following requirements for Geotextile fabric.
  - Grab Tensile Strength: >440N (ASTM D4632)
  - Tensile Modulus: 0.140 pa (minimum)
  - Apparent Opening Size: 0.1 – 0.5 mm (ASTM D4751)
- Always install silt fences along the contour.
- Excavate a trench a minimum of 200mm wide and 200mm deep along the proposed line of the silt fence.
- Use supporting posts of tanalised timber a minimum of 50mm square, or steel waratahs at least 1.5m in length.
- Install the support posts/waratahs on the downslope edge of the trench and silt fence fabric on the upslope side of the support posts/ waratahs to the full depth of the trench, then backfill the trench with compacted soil.
- Reinforce the top of the silt fence fabric with a support made of high tensile 2.5mm diameter galvanised wire. Tension the wire using permanent wire strainers attached to angled waratahs at the end of the silt fence.
- Where ends of silt fence fabric come together, ensure they are overlapped, folded and stapled/screwed to prevent sediment bypass.

**Figure 9-8**  
**Schematic of a Silt Fence**

Standard detail  
for Silt Fence

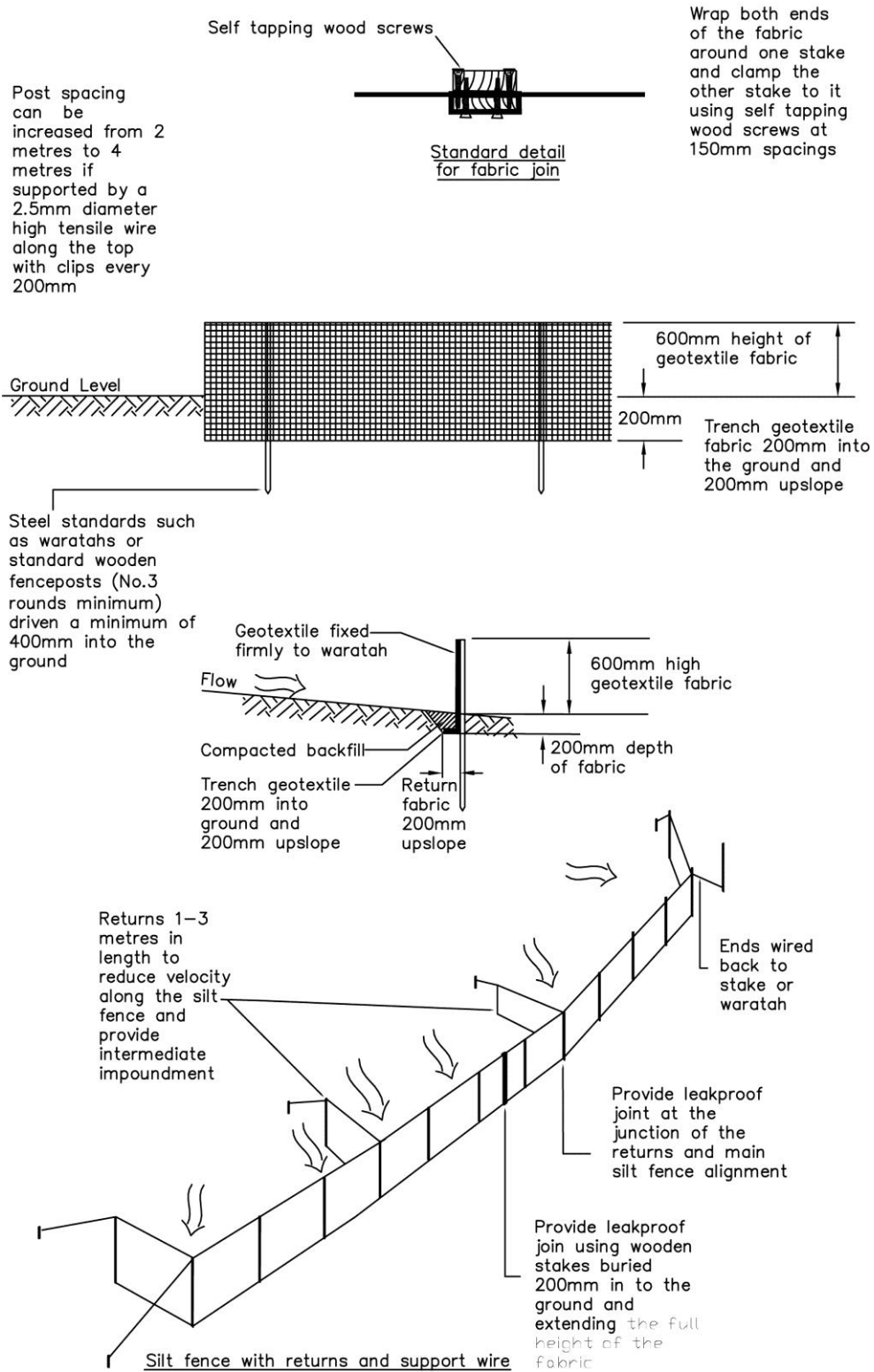

## 9.2.6 Maintenance

Silt fences require the following maintenance;

- Inspect silt fences at least once a week and after each rainfall.
- Check for damage including rips, tears, bulges in the fabric, broken support wires, loose posts/ waratahs, overtopping, outflanking, undercutting, and leaking joins in fabric.
- Make any necessary repairs as soon as identified.
- Remove sediment when bulges occur or when sediment accumulation reaches 20% of the fabric height.
- Remove sediment deposits as necessary (prior to 20% of fabric height) to continue to allow for adequate sediment storage and reduce pressure on the silt fence.
- Dispose of that sediment to a secure area to ensure that it does not discharge to the receiving environment.

## 9.2.7 Decommissioning

In decommissioning silt fences consider the following:

- Do not remove silt fence and accumulated sediment until the catchment area has been appropriately stabilised.
- Remove and dispose of accumulated sediment.
- Backfill trench, re-grade and stabilise the disturbed area.

## 9.3 Super silt fence

### 9.3.1 Definition and purpose

A super silt fence is a temporary barrier of woven geotextile fabric over a chain link fence that is used to capture predominantly coarse sediments carried in sheet flow. Super silt fences temporarily impound sediment laden runoff, reducing velocities and allowing sediment to settle out of the water.

The purpose of a super silt fence is to detain flows from runoff so that deposition of transported sediment can occur through settlement and some filtration.



### 9.3.2 Conditions where practice applies

Super silt fences apply when:

- A barrier is needed to collect and hold debris and soil, preventing the material from entering critical areas, watercourses and streets.
- Can be used where the installation of an earth or topsoil bund would destroy sensitive areas such as bush and wetlands.
- Should be placed as close to the contour as possible. No section of the fence should exceed a grade of 5% for a distance of more than 15m.

### 9.3.3 Limitations

Super silt fences have the following limitations:

- Super silt fences do not capture many soil particles finer than 0.02mm in diameter (for example fine silts and clays) due to the short detention time of water behind the super silt fence and relatively large pore size of most fabrics.
- The pores in the super silt fence fabric become clogged relatively quickly with fine textured sediments, which result in the fabric becoming impermeable.
- Relative to other measures they can have a high cost.
- Only used for sheet flow not concentrated flow. Do not use super silt fences as checks dams in channels (to reduce velocities) or place them where they will intercept concentrated flow.
- Super silt fences should be used a part of a treatment train approach.

### 9.3.4 Key design criteria

The following shall be applied when designing super silt fences:

- When considering super silt fence installation for larger catchments (greater than 0.5ha) as in Table 6-10, carefully consider the specific site conditions and other alternative control measures available.
- Base the length of the super silt fence on the limits shown in Table 9-3. Limits imposed by ultraviolet light affect the stability of the fabric and will dictate the maximum period that the super silt fence may be used.
- Where ends of the geotextile fabric come together, overlap, fold and staple the fabric ends to prevent sediment bypass (Figure 9-9).

**Table 9-3 Super silt fence design criteria**

Slope steepness %	Slope length (m) (Maximum)	Spacing of Returns (m)	Super silt fence length (m) (Maximum)
0 - 10%	Unlimited	60	Unlimited
10 - 20%	60	50	450
20 - 33%	30	40	300
33 - 50%	30	30	150
> 50%	N/A	20	N/A

- The geotextile fabric must meet the following requirements:
  - Tension strength 0.345 pa (minimum)
  - Tensile modulus 0.140 pa (minimum)
  - Apparent opening size 100 - 500 mm

### 9.3.5 Construction

When constructing a super silt fence, apply the following:

- Use super silt fence material appropriate to the site conditions and in accordance with the manufacturer's specifications.
- Always install super silt fences along the contour.
- Excavate a trench a minimum of 200 mm wide by 300 mm deep along the proposed line of the super silt fence.
- Use supporting posts of tanalised timber (No. 3 rounds, No. 2 half rounds), or steel waratahs at least 1.8m in length.
- While there is no need to set the posts in concrete, ensure the 1.8m long posts are driven to an appropriate depth (1 m minimum).
- Install tensioned galvanised wire (2.5 mmHT) at 400mm and again at 800mm above ground. Tension the wire using permanent wire strainers attached to angled waratahs at the end of the super silt fence.
- Secure chain link fence to the fence posts with wire ties or staples, ensuring the chain link fence goes to the base of the trench.



- Fasten two layers of geotextile fabric securely to the super silt fence with ties spaced every 600mm at the top and mid-section of the super silt fence.
- Place the two layers of geotextile fabric to the base of the trench (a minimum of 300mm into the ground) and place compacted backfill back to the original ground level.
- Embed geotextile support into the ground by 300 mm upslope for 200 mm.
- When two sections of geotextile fabric adjoin each other, ensure they are doubled over a minimum of 300mm, wrapped around a batten and fastened at 75mm spacings to prevent sediment bypass.
- The geotextile fabric must meet the following requirements:

Grab Tensile Strength:	>440N (ASTM D4632)
Tensile Modulus:	0.140 pa (minimum)
Apparent Opening Size	0.1 – 0.5 mm (ASTM D4751)

**Figure 9-9**  
**Schematic of a Super Silt Fence**

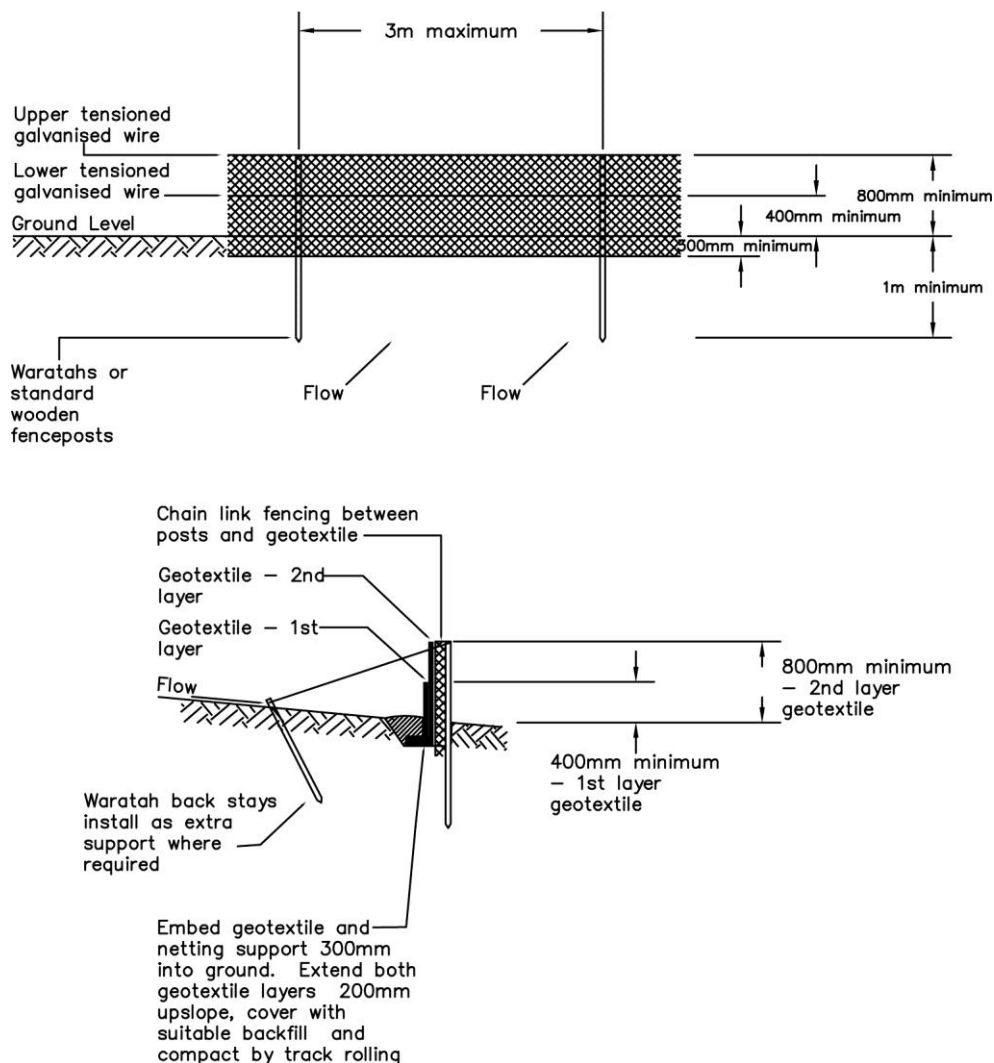

### **9.3.6 Maintenance**

Super silt fences require the following maintenance:

- Inspect super silt fences at least once a week and after each rainfall.
- Check for damage including rips, tears, bulges in the fabric, broken support wires, loose posts/ waratahs, overtopping, outflanking, undercutting, and leaking joins in fabric.
- Make any necessary repairs as soon as identified.
- Remove sediment when bulges occur or when sediment accumulation reaches 20% of the fabric height.
- Remove sediment deposits as necessary (prior to 20% of fabric height) to continue to allow for adequate sediment storage and reduce pressure on the super silt fence.
- Dispose of that sediment to a secure area to ensure that it does not discharge to the receiving environment.

### **9.3.7 Decommissioning**

In decommissioning super silt fences consider the following:

- Do not remove the super silt fence and accumulated sediment until the catchment area has been appropriately stabilised.
- Remove and dispose of accumulated sediment.
- Backfill trench, re-grade and stabilise the disturbed area.

## 9.4 Filter socks

### 9.4.1 Definition and purpose

A tubular sediment control practice, consisting of a mesh tube filled with a filter material (e.g. compost, sawdust, straw) used to intercept and filter runoff.

Its purpose is to:

- Intercept and filter overland site runoff,
- Intercept and filter runoff before it enters a cesspit or inlet,
- Reduce the velocity of runoff within a channel (described in Section 8.2.1),
- To contain and filter discharges from pumped stormwater or concrete wash water.

### 9.4.2 Conditions where practice applies

Conditions where the practice applies include:

- Perimeter control,
- Inlet protection,
- Slope length reduction,
- Flow diversion for small catchment areas, or
- Where concrete wash water or pumped stormwater is required to be treated prior to discharge.

### 9.4.3 Limitations

Limitations include:

- Not suitable as perimeter control or slope length reduction when there is concentrated flow,
- Can be used improperly in lieu of more appropriate practices,
- Uneven ground may cause flow under the filter sock.

### 9.4.4 Key design criteria

Several types of materials can be used for filter material in the sock. The key is to achieve proper balance between sediment removal and flow-through rate so particle size is important. Filter material with a high percentage of fine particles will clog and create a barrier to flow. This will cause water to pond and the pressure could cause failure.

Ensure the appropriate sized filter sock is used per Tables 9-4 and 9-5.

**Straw filled filter sock**  
(Image provided by Erosion Control Co. Ltd.)



**Table 9-4: 300 mm diameter filter sock criteria**

300 mm Diameter Filter Sock		
Slope steepness %	Maximum Slope length (m)	Spacing of returns (m)
< 2%	100	Unlimited
2% - 10%	40	30
10% - 20%	30	25
20% - 33%	10	10
33% - 50%	5	10
> 50%	2	5

**Table 9-5: 450 mm diameter filter sock criteria**

450 mm Diameter Filter Sock		
Slope steepness %	Maximum Slope length (m)	Spacing of returns (m)
< 2%	150	Unlimited
2% - 10%	60	30
10% - 20%	40	25
20% - 33%	20	20
33% - 50%	10	10
> 50%	5	5

#### Compost filter media

When compost is used as fill, it shall be free of contaminants and meet the Table 9-5 specifications.

**Table 9-6: Filter sock fill material specifications**

Parameter	Unit of Measure	Specification
pH	pH units	5.0 - 8.5
Moisture content	% dry weight basis	>60
Organic Matter Content	% dry weight basis	25 - 100
Particle Size	% passing a selected mesh size, dry weight basis	50 mm 99% passing; 10 mm 30-50% passing (50-70% retained); Maximum 50 mm

#### Sawdust filter media

- No treated wood as a source material, and
- Free from contaminants.

#### Straw specification

- Free from weed seeds, and
- Free from contaminants.

The material used to fill the sock will depend on its purpose. If the sock is to be used as a filter, porous material like rocks or wood bark will not be effective.

### 9.4.5 Construction

- Filter socks can either be filled on site or prefabricated in suitable lengths prior to site delivery.
- The filter sock shall be produced from HDPE or polyester material with abrasion resistance netting weaves (a thread diameter of not less than 0.3 mm). The recommended weave for compost sock is an opening in the knitted mesh of 1-5 mm when filled and for straw socks no more than 20 mm openings.
- Always install filter socks on the contour. Where this is impossible or where there are long sections of filter sock, install short filter sock returns projecting upslope from the filter sock to minimise flow concentration. Returns are to be a minimum of 2 m in length.
- Where more than one length of filter sock is used, the filter socks are to be overlapped a minimum of 1 m, or according to the manufacturer's recommendation, joined by a sleeve.
- Install filter sock 'wings' at either end of the filter sock projecting a sufficient length upslope to prevent outflanking.
- Filter socks are to be pegged and secured.

**Straw sock secured in place using stakes and bale twine. Stakes are placed every 600 mm.**  
(image provided by Erosion Control Co. Ltd.)



### 9.4.6 Maintenance

- Filter socks should be inspected regularly and after each rainfall event to ensure filtration and sediment control performance is maintained,
- Accumulated sediment greater than 50% of the filter sock height should be removed or another filter sock placed on top of the existing sock to maintain effective sediment control.
- Excessive ponding behind the filter sock indicates that the filter media is clogged and sediment control performance reduced. The sock should then be replaced to re-establish drainage.
- Reuse of filter socks is acceptable provided the integrity of the sock and fill media is maintained.

### 9.4.7 Decommissioning

Filter sock media shall either be removed from the site once site stabilisation has been accomplished or the media should be dispersed on site in such a way as to facilitate and not obstruct drainage or site stabilisation.

## 9.5 Decanting earth bund

### 9.5.1 Definition and purpose

Decanting earth bunds are a temporary bund or ridge of compacted earth constructed to create impoundment where ponding or runoff can occur and suspended material can settle out before runoff is discharged.

The purpose of a decanting earth bund is to intercept sediment laden runoff and reduce the amount of sediment leaving the site by incorporating a device to dewater the decanting earth bund at a rate that will allow suspended sediment to settle out.

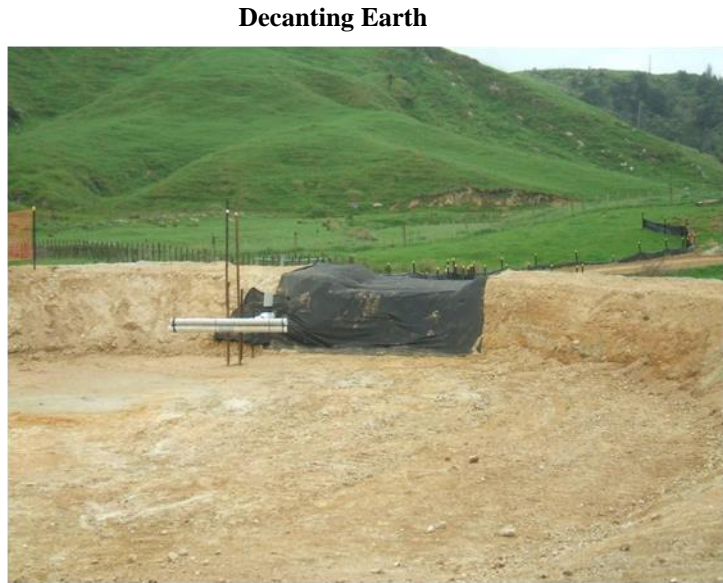

### 9.5.2 Conditions Where Practice Applies

Decanting earth bunds apply when:

- Decanting earth bunds can be constructed across disturbed areas and around construction sites and subdivisions. Keep them in place until the disturbed areas are permanently stabilised or adequately replaced by other means.
- Decanting earth bunds are particularly useful for controlling runoff from small areas that are isolated from the main site controls because of site layout or because of site infrastructure such as roading or drainage restricting flow to the main site controls.

### 9.5.3 Limitations

Decanting earth bunds have the following limitations:

- Decanting earth bunds capture and treat slightly finer soil particles than silt fences but are not as effective in sediment removal as sediment retention ponds.
- Short circuiting can occur because they generally do not have a defined inlet.
- They are usually more effective on flatter slopes where runoff velocities are less.
- Recommended maximum catchment size is shown in Table 9-7:

**Table 9-7: Soil type and slope versus maximum catchment area**

Soil types/slope	Maximum Catchment Area (in hectares)
Flat gravel (<5%)	1.0
Sloping gravel (>10%)	0.8
Flat silt loam (<5%)	0.5
Sloping silt loam (10-20%)	0.4
Steep silt loam (>20%)	0.3
Clay (<10%)	0.3
Clay (>10%)	0.3

- Decanting earth bunds should be used a part of a treatment train approach.

### 9.5.4 Key design criteria

When designing decanting earth bunds consider the following criteria:

- Decanting earth bunds, as shown in Figure 9-10 and cross-section Figure 9-11, need a constructed outlet structure and emergency spillway as designed for sediment retention ponds.
- Decanting earth bund volumes are sized as for sediment retention ponds and in accordance with the methodology outlined in Section 6.
- The impoundment area of the decanting earth bund is to be level and have a length to width ratio for the main inflows of between 3:1 and 5:1. A diversion bund may be required to achieve this.
- The maximum height of the decanting earth bund to the invert of the spillway is 1m.
- The decanting earth bund is to have a minimum base width of 3m and a maximum batter grade of 1:1.
- Particular attention needs to be given to soil type, for example pumice soils may require the design and installation of an anti-seep or filter collar.

**Figure 9-10**  
**Decanting Earth Bund with a Floating Decant**

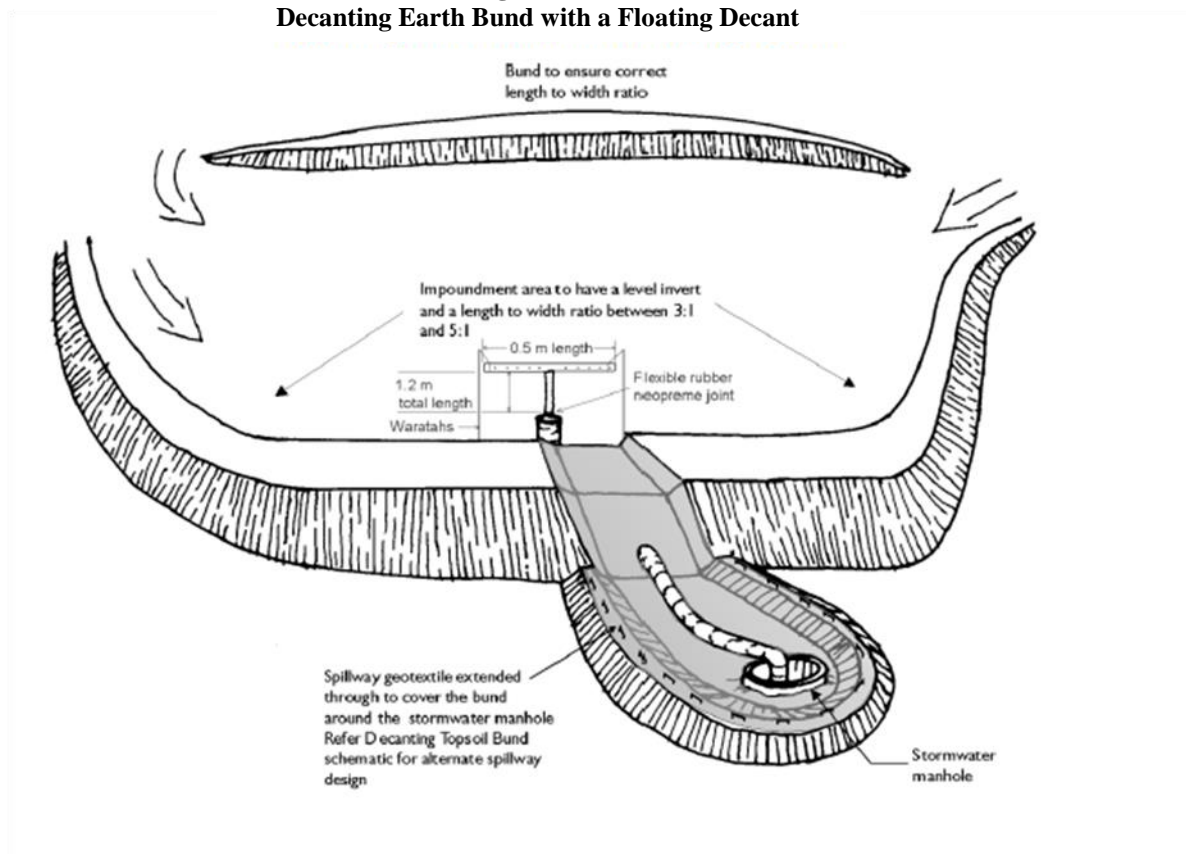

**Figure 9-11**  
**Cross-section of a Floating Decant**

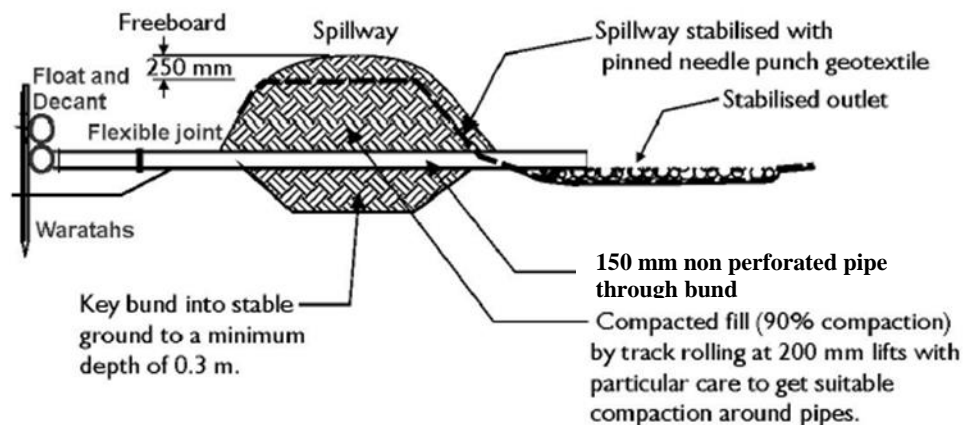

### 9.5.5 Construction

Consider the following when constructing decanting earth bunds:

- Build decanting earth bunds along the contour to obtain required volumes.
- Remove all organic/ vegetation before construction.
- The decanting earth bund is to be keyed into the existing ground to a minimum depth of 0.3m.
- The decanting earth bund is to be made with a clay-silt mix of suitable moisture content to achieve a reasonable compaction standard (90%). It is considered that this can be achieved, in most instances, by track rolling at 150 - 200 mm lifts. Particular care is required to achieve good compaction around the outlet pipe that passes through the bund to avoid seepage and potential failure.
- Install a 150 mm diameter non-perforated outlet pipe through the bund and this is to discharge to a stable erosion proofed area or stormwater system.
- A T-Bar decant is attached by way of a standard 100mm tee joint (glued and screwed). The decant is 100mm dia. PVC pipe 0.5m long with 20 equally spaced holes of 10mm diameter and fixed firmly to a waratah standard to achieve 3l/sec/ha of contributing catchment.
- A sealed PVC pipe (with endcaps) is placed on top of the decant to provide buoyancy.
- Use a flexible thick rubber coupling to provide a connection between the decant arm and the discharge pipe. To provide sufficient flexibility (such as is required for the lower decant arm) install two couplings. Fasten the flexible coupling using strap clamps, glue and screws.
- The decant is fastened to two waratahs by way of a nylon cord to the correct height.
- Provide an emergency spillway to a stabilised outfall 150mm above the level of the top of the decanting novacoil pipe. This can be a trapezoidal spillway with a minimum invert length of 2 m which is smooth, has no voids and is lined with a soft needle punched geotextile to the stabilised outfall. Ensure the geotextile is pinned at 0.5m centres.
- The emergency spillway is to have a minimum freeboard of 250mm, i.e. between the invert of the spillway to the lowest point of the top of the bund.



- Undertake an As Built assessment at the completion of construction to check against design. If there are any discrepancies rectify immediately.

### 9.5.6 Maintenance

Decanting earth bunds require the following maintenance requirements:

- Inspect decanting earth bunds at least once a week and after each rainfall event.
- Check for damage including:
  - Spillway is secure and functional
  - Erosion at outlet, remedy if required or look at diverting outlet
  - Damage to decant and fittings
  - Seepage through embankment, or along outlet pipe
  - Blockages to holes in decants
- Make any necessary repairs as soon as identified.
- Remove sediment when sediment accumulation reaches 20% of volume.
- Dispose of removed sediment to a secure area to ensure that it does not discharge back into decanting earth bund or to the receiving environment.

### 9.5.7 Decommissioning

Consider the following when decommissioning decanting earth bunds:

- Do not remove decanting earth bund and accumulated sediment until the catchment area has been appropriately stabilised.
- Refer to 9.7 for dewatering.
- Remove and dispose of accumulated sediment.
- Remove pipes, fabric and other construction materials.
- Backfill, re-grade and stabilise the disturbed area.

## 9.6 Flocculation

### 9.6.1 Definition and purpose

Flocculation is a method of enhancing the retention of suspended sediment in earthworks runoff. Liquid flocculent is added to sediment retention pond inflows via a rainfall-activated system. The flocculent causes individual particles to be destabilised (i.e. neutralising electrical charges that cause particles to repel each other), accelerating the coagulation and settlement of particles that may otherwise be discharged from the pond.

The purpose is:

- To treat sediment laden runoff to an extent greater than standard sediment control practices, and
- To reduce the volume of sediment leaving a site, thus protecting downstream environments from excessive sedimentation and water quality degradation.

In a number of environments and soil types, chemical treatment is the only method that will disperse colloidal material. Those in use tend to be bioadhesives, which readily bind to negatively charged surfaces. As such flocculants work best with soil particles having a negative charge, which means that flocculation works best for removal of clay particles as opposed to larger particles not having a negative charge.

Rain Activated Flocculent Dosing



### 9.6.2 Conditions where practice applies

Flocculation is used to enhance the retention of sediment on earthworks sites where there are potential adverse effects on sensitive receiving environments, cumulative effects of earthwork operations, scale of project, and where dispersive soils (particle size < 0.005mm) are present.

It is necessary to check with the local consenting authority for local guidance on when flocculation is required and whether local approval of flocculation is necessary and required.

### 9.6.3 Limitations

Flocculation has the following limitations:

- Dosing should cease when the pH drops below 5.5.
- Flocculation generally works on dispersive soils (particle size < 0.005mm). Flocculation is less effective on other soil types.
- Flocculation requires a high degree of monitoring and maintenance.
- Spills of flocculent can have significant adverse effects on the receiving environment.
- Flocculation will have a price implication on a project.
- In significant rainfall events (>15mm in 24 hours), the rate of flocculation usage needs to be carefully monitored so that the systems does not run out of chemical.

## 9.6.4 Key design criteria

### 9.6.4.1 General system details

- The general components of the flocculation system include:
  - rainfall catchment tray;
  - header tank;
  - displacement tank; and
  - flocculent reservoir tank, as detailed in Figures 9-12, 9-13 and 9-14.

**Figure 9-12**  
**Flocculation System Components**

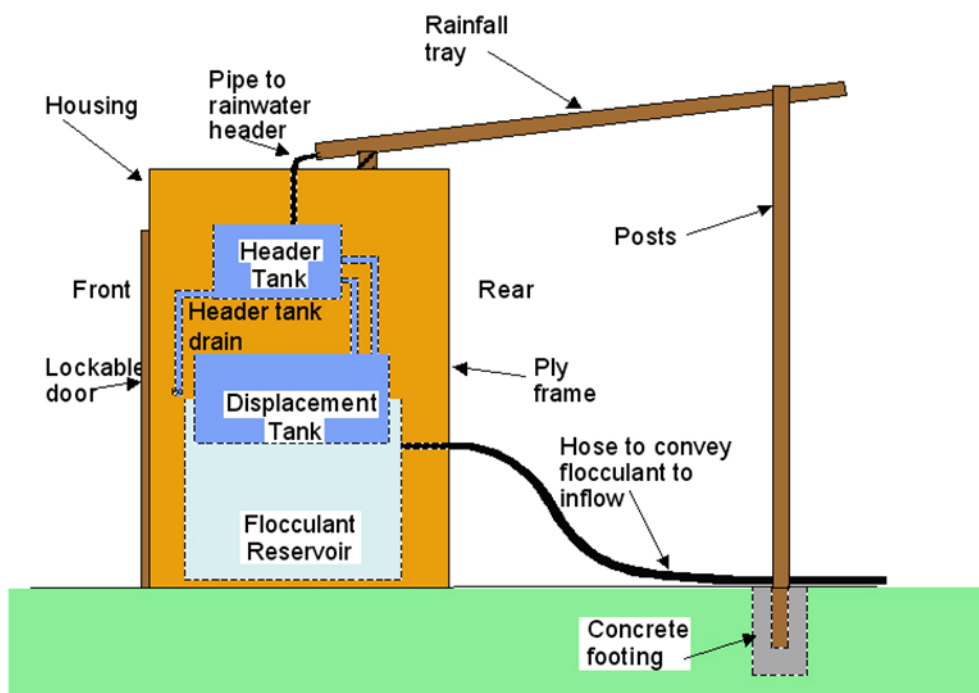

- Rainfall from the catchment tray drains to a header tank. The header tank provides storage capacity to avoid dosing during initial rainfall following a dry period and attenuate dosing at the beginning and end of a rainstorm (to simulate the runoff hydrograph). The header tank provides:
  - Zero flocculent discharge until a pre-selected quantity of rain has fallen, to allow for initial infiltration and saturation of dry ground before runoff commences;

**Figure 9-13  
Rainfall Catchment Tray**

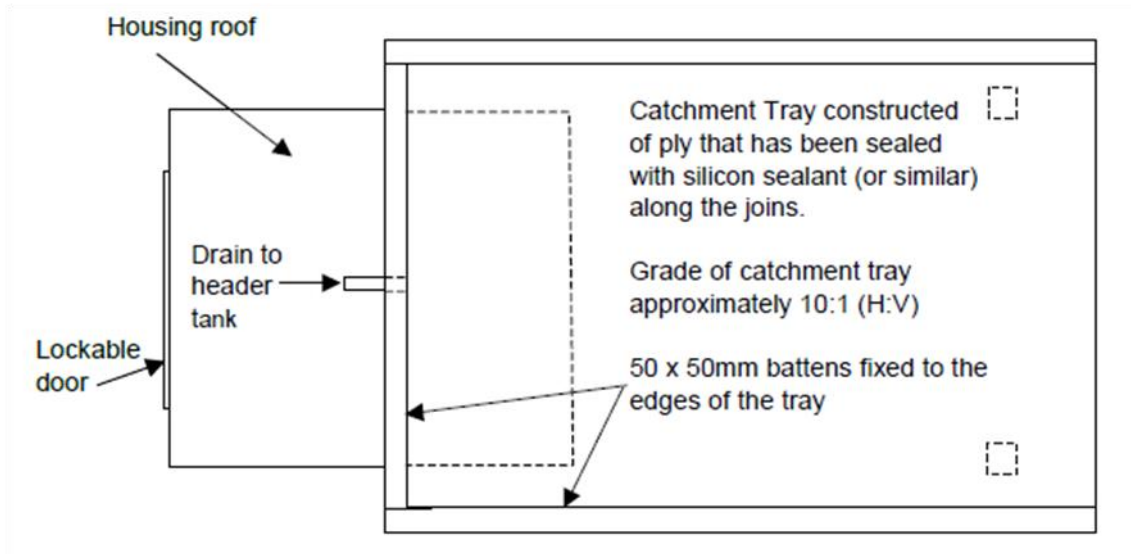

- A slow start to the dosing rate to allow for the response time of runoff flowing off the site at the beginning of a storm; and
  - An extension of the dosing period beyond the rainfall period to provide treatment of runoff that occurs following cessation of rainfall.
- From the header tank, the rainwater discharges by gravity into a displacement tank which floats in the flocculent reservoir. As the displacement tank fills with rainwater, flocculent is displaced through the outlet in the reservoir tank and then flows by gravity to the dosing point. The dosing point should be selected in an area of high turbulence in the pond inflow channel.

**Figure 9-14  
Flocculation System Dosing Detail**

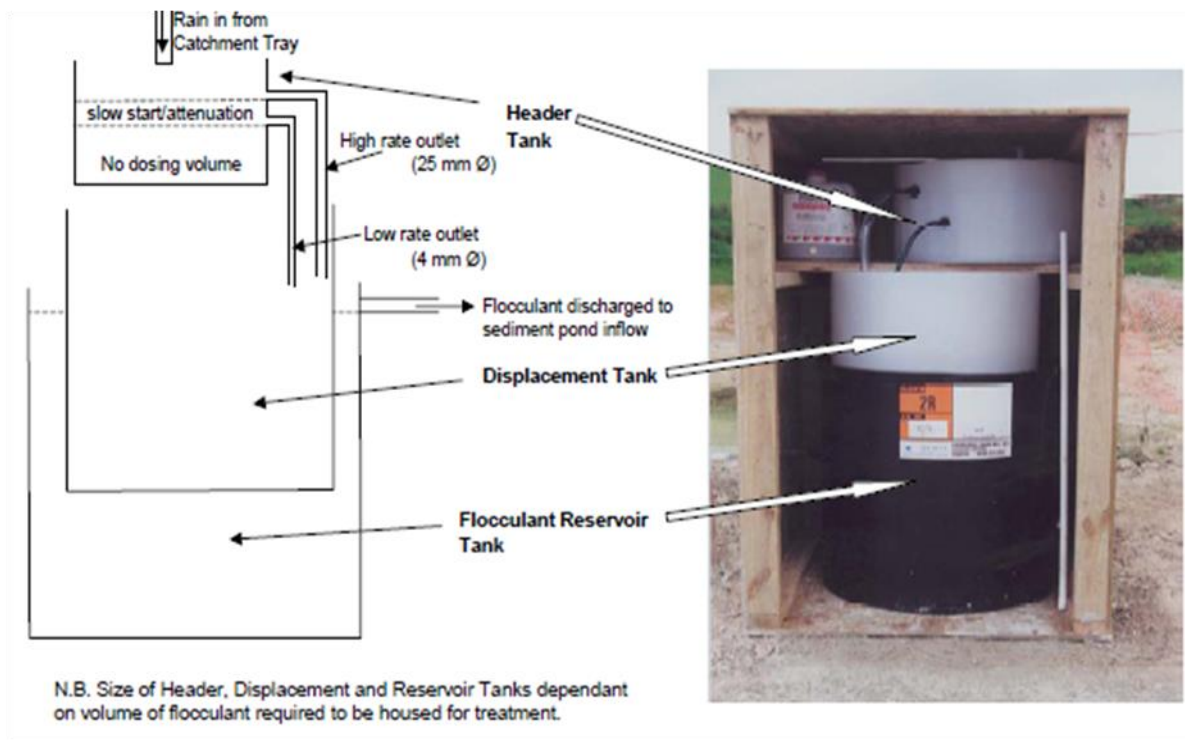

### 9.6.4.2 Rainfall catchment tray

- The size of the constructed catchment tray is determined by the size of the catchment draining to the sediment retention pond. The tray is sized on the assumption that 100% of runoff from the saturated earthworks areas, and 60% runoff from the stabilised contributing catchment area will require treatment at the design dose rate. The construction of the tray is set out in Figure 9.14.
- The following assumptions are made for the calculation of the rain catchment tray area for a 1ha catchment draining to a sediment retention pond utilising flocculation.
  - Laboratory tests using sediment-laden runoff from the site, or from a site that has similar soil characteristics will need to be undertaken and the optimal dose determined.
  - 1L of liquid poly aluminium chloride (PAC) typically contains 64.2 g of aluminium (based on 10.1% of  $Al_2O_3$  by weight). When designing the rainfall tray, the chemical supplier should be contacted to confirm the percentage of  $Al_2O_3$ .
  - As an example on Auckland's Waitemata clay soils, 1L of PAC will treat 8,020L of stormwater at a dose rate of 8mg aluminium/L.
  - For the purposes of sizing the tray, a 50mm storm event is considered. The runoff volume to be treated from 50mm of rainfall is 500m<sup>3</sup> for a 1 ha catchment.
  - The volume of PAC required to treat 500m<sup>3</sup> of runoff is 62.3L.
  - The density of PAC is 1.2, therefore 74.8L of rainwater needs to be collected to displace 62.3 L of PAC.
  - To collect 74.8 L of rainwater from a 50mm rainfall event requires an area of 1.5m<sup>2</sup>.
  - A larger catchment tray will be required for a larger contributing catchment area.
- Tests need to be done on the sites soils to determine optimal dosing rates on disturbed lands.

**Header**



**Flocculation Shed**



#### 9.6.4.3 Header tank

- The zero (flocculent) discharge rainfall volume can be adjusted manually for site characteristics by adding or removing water from the header tank.
- Low rate and high rate outlets are to be installed. The low rate outlet consists of a 4mm internal diameter hose. The high rate outlet needs to have sufficient capacity to convey the maximum predicted flow from short-term rainfall, up to 40mm/hour. A pipe with an internal diameter of 25mm is suggested, although systems treating large catchments may require larger pipes.
- The slow start/attenuation characteristics can be regulated for site characteristics by providing more than one low rate outlet and at different levels from the header tank.
- The standard header tank design provides for up to 12mm of rainfall before dosing commences. This requires provision of a delayed start volume below the low rate outlet of the header tank of 10 L/m<sup>2</sup> of rainfall catchment tray (for a 1.5m<sup>2</sup> catchment tray, the invert of the low rate outlet will be at the height reached by 15 L of water within the header tank). The high rate outlet invert should be positioned at that point reached by half the 50mm storm event (for a 1.5m<sup>2</sup> catchment tray, the invert of the high rate outlet will be at the height reached by 37.5 L of water within the header tank).
- The header tank should have sufficient capacity to contain rainfall without over topping. 50 mm of freeboard above the top of the high rate outlet pipe provides this capacity.

#### 9.6.4.4 Displacement tank

- The displacement tank needs to be a neat fit inside the flocculent reservoir tank.
- The displacement tank must have capacity to hold runoff from the 1 in 2 year event as calculated from the methodology in Section 6 of the Standard.
- The standard size of the displacement tank 400L.

#### 9.6.4.5 Flocculent reservoir tank

- The flocculent reservoir tank needs to be only slightly larger than the displacement tank. However, the larger the reservoir and displacement tanks are, the less servicing that is required.
- The flocculent reservoir tank requires sufficient capacity to provide for the dosing of runoff from the 1 in 2 year event rainfall event.
- Sufficient capacity to dose a large storm, generally 500L.
- A 20mm diameter outlet hose needs to be installed in the side of the tank to drain the flocculent to the pond inlet channel. The outlet will be located at the point that will retain 400L of floc without displacement (2 x 200L drums).
- The dosing point of the outlet into the sediment laden diversion should be at least 10m upstream of the forebay.

## 9.6.5 Maintenance

Flocculent systems require the following maintenance requirements:

- The maintenance requirements of the flocculent system need assessing following every rainfall event, or during rainfall events if exceptionally heavy and/or prolonged rainfall occurs.
- Prior to staff leaving the site unattended for weekends, the flocculation unit requires servicing by the responsible site staff member so that the maximum amount of runoff can be treated by the dosing system.
- The following matters outline maintenance requirements for the flocculation system. It is noted that these systems may require some ongoing manipulation to suit the site characteristics and runoff.

### 9.6.5.1 Header tank

- The header tank is used to avoid dosing during the initial stages of rainfall when site conditions are dry and no runoff is to be expected.
- The volume in the header tank is lowered using the lowest of the three outlet tubes.
  - After 3 days without rain - reduce volume to 50%.
  - After 6 days without rain - reduce volume to empty (level at lowest outlet).
- In wet weather or if the site is generally wet, water may be added manually to the header tank to cut down the response time so that the system responds more rapidly after rain commences.
- If the system is to be operated over the winter period, then the system should also be set to no delay.
- Adjusting the water level within the header tank is to prevent under or overdosing of the pond. Under-dosing may lead to higher levels of suspended sediment being discharged from the pond, while overdosing may cause a reduction in pH, raising the potential for aluminium within the PAC to react forming toxic aluminium compounds (that are bioavailable to fresh and marine water organisms).

### 9.6.5.2 Refilling the chemical reservoir

- When the volume of flocculent in the reservoir tank is reduced to the degree that there is insufficient to dose a major storm, the displacement tank needs emptying and the flocculent reservoir refilled.
- The displacement tank may either be emptied using a siphon, or baled out by hand. The flocculent reservoir may be filled using a drum pump, to pump from a 200L drum.

### 9.6.5.3 Monitoring and adjusting for changing site conditions

- Each new flocculent treatment system needs to be monitored carefully during the first few rainfall events to check that the system is effective, and to ensure that overdosing is not occurring.
- If overdosing is suspected because the pond dead storage water is exceptionally clear, samples must be taken from the pond for pH and dissolved aluminium analysis. The dosing regime should be adjusted depending on the outcome of these results.

- If overdosing occurs or it is clear that the quality of stormwater runoff is improving because of stabilisation of the site, the flocculent dose must be reduced by reducing the size of the catchment tray. This can be done by placing and sealing a board (batten) diagonally across the tray with a hole through the tray rim at the lower corner, so that water from the tray area above the batten discharges to waste.
- The size of the rainfall catchment tray requires modification if earthworks alter the extent of the contributing catchment. Failure to do so will cause either under or overdosing of flows entering the sediment retention pond.
- Other maintenance includes the removal of any debris such as leaves from the catchment tray to ensure that rainwater enters the header tank. The low and high rate hoses need to be checked regularly for blockages. In addition, all hose fittings need to be inspected regularly to identify any leakages.

#### **9.6.5.4 Contingency management**

- Contingencies could include poor performance of the treatment system, or effects of other influences on stormwater quality, such as reduced pH, that might make the use of PAC inappropriate.
- If the treated water in the pond is consistently very clear it could indicate overdosing, and the possibility of lowered pH which can present a risk to receiving waters as a result of elevated free aluminium concentration in the discharge. If the treated water is consistently clear the pH of the water in the pond should be tested.
- Contingencies such as poor treatment performance or consistently very clear treated water should be dealt with by consulting an appropriately qualified person to advise on an appropriate action.

#### **9.6.5.5 Spill management**

- If there is a spill of PAC onto the ground it should be immediately contained using earth bunds to prevent it entering water. The spilt PAC should be recovered if possible and placed in polyethylene containers. If the spilt PAC cannot be recovered, it should be mixed with a volume of soil equal to at least ten times the volume of spilt PAC. This will effectively neutralise the PAC. The soil with which the PAC has been mixed should be buried a minimum of 0.5m below the surface.
- If there is a spill of PAC into ponded water, discharge from the pond to natural water should be prevented.
- If there is a spill of PAC into flowing water:
  - The appropriate council should be advised immediately.
  - The volume of the spill should be recorded.
  - If possible the water and spilt PAC should be pumped into a bund or pond until all the spilt PAC has been removed from the watercourse.
  - If the PAC cannot be removed from the watercourse any downstream users should be identified and advised.

#### **9.6.6 Decommissioning**

When decommissioning flocculation systems remove all components of the flocculation shed, store for use on another pond.



### **9.6.7 Alternatives to aluminium based flocculants**

All alternative systems will require specific approval from the appropriate local authority prior to use. Furthermore the discharge of chemical to the receiving environment may require specific approval from the appropriate local authority.

## 9.7 Dewatering

### 9.7.1 Definition and purpose

Dewatering is the removal of water from excavations, trenches and sediment control devices. Dewatering is generally done by pumping. This process can generate fine textured material that is difficult to treat and retain onsite, even through robust sediment control devices, such as those in this standard.

### 9.7.2 Conditions where practice applies

Dewatering devices apply:

- To dewater trenches, excavations and sediment control devices at decommissioning stage.
- To dewater cofferdams where water must be kept out of excavation in which a bridge pier or other structure is built.

### 9.7.3 Limitations

Dewatering has the following limitations:

- Take care when pumping as it produces fine textured sediment which can have adverse environmental effects.
- Always try to minimise the volume of water that requires dewatering, such as limiting length of open trench or providing diversions above excavations.

### 9.7.4 Key design criteria

When considering options available to dewater, consideration must be given to the following:

- Minimising the volume of water and the levels of sediment.
- Retaining sediment laden water onsite to maximise the settling of sediment onsite (settling may be aided by the addition of flocculent).
- Always dewater the cleaner water at the top first, then pump the residual sediment laden water to a tank/ truck. This water can be used as a dust suppressant or to aid compaction.
- Small volumes of sediment laden water can be pumped to a silt fence or decanting earth bund, however care needs to be taken to ensure that these devices are not overwhelmed.
- Larger volumes can be pumped to a sediment retention pond. Always pump to the forebay.

Uncontrolled



Dewatering Skip Bin



Settling tanks/ skip bins/ dewatering bags can be used in many situations.

When constructing a cofferdam, the following is appropriate:

- Sheet piling is driven around the works site, seal concrete is placed into the bottom to prevent water from seeping in from underneath the sheet piling and the water is pumped out and handled as discussed earlier in this section. A schematic is shown in Figure 9-15.
- The loads imposed on a cofferdam include the hydrostatic forces of water as well as the dynamic forces due to currents and waves.
- The types of cofferdam can include braced, earth-type, timber crib, double-walled sheet pile and cellular. They should all be designed by a structural engineer to ensure adequacy and safety.
- Removal of the cofferdam must be planned and executed with the same degree of care as its installation, with a staged approach. The effect of removal on the permanent structure must also be considered. For this reason, sheet piles extending below the permanent structure are often cut off and left in place, since their removal may damage the foundation soils adjacent to the structure.

**Figure 9-15**  
**Cofferdam Schematic**

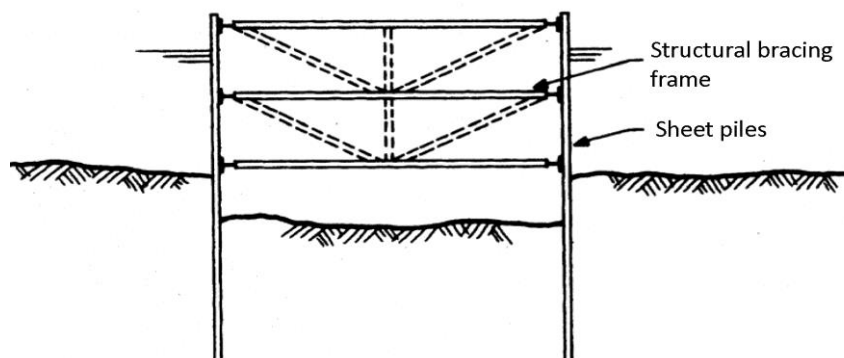

**Dewatering Bag and  
Pipe Sock**

## 9.8 Stormwater inlet protection

### 9.8.1 Definition and purpose

Stormwater inlet protection is a barrier across or around a cesspit (stormwater inlet). It is used to intercept and filter sediment-laden runoff before it enters a reticulated stormwater system via a cesspit, thereby preventing sediment-laden flows from entering receiving environments. The protection may take various forms depending upon the type of inlet to be protected.

Stormwater inlet protection is a secondary sediment control device and must not be used as a standalone device. It must only be used in conjunction with other erosion and sediment control measures. If good erosion and sediment control measures are in place on the site, then stormwater inlet protection will not be required.

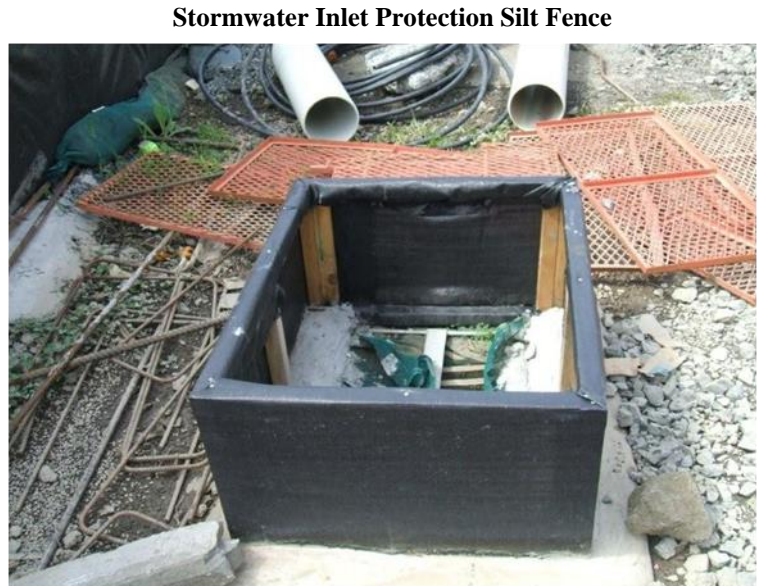

### 9.8.2 Conditions where practice applies

Stormwater inlet protection applies:

- Used for small low gradient catchments (< 0.25ha with slopes < 5%) as a component of a broader erosion and sediment control system.

### 9.8.3 Limitations

Stormwater inlet protection has the following limitations:

- Only to be used in very small catchments (< 0.25ha).
- Not to be used as a standalone treatment device.
- Should be used a part of a treatment train approach.
- Relatively low sediment removal efficiency.
- Low sediment storage capacity.
- High maintenance requirements.
- Potential for blockage and therefore increased risk of inundation to downstream/network device.
- Can cause flooding to road carriageway due to limited hydraulic capacity.
- Easily damaged by vehicles and construction equipment.
- Public safety issues.

## 9.8.4 Key design criteria

Consider the following design criteria for stormwater inlet protection:

- Do not completely block the stormwater system as this will divert flows during heavy rain which may cause other devices to become overwhelmed.
- Devices must not be used near the edge of fill and must not divert water down slopes, or away from the stormwater inlet.

### Stormwater Inlet Protection



#### 9.8.4.1 Silt fence

- A silt fence can be erected around the inlet. This method is appropriate where cesspits have been connected to a stormwater system and are collecting runoff from disturbed soil surfaces.

#### 9.8.4.2 Filter media design

- All points where runoff can enter the cesspit must be protected with suitable geotextile fabric (Figure 9-16). Lay coarse geotextile fabric over the cesspit and up onto the kerb with a layer of aggregate material to act as a primary filter and to hold the fabric in place.

#### 9.8.4.2 Filter socks

- For use as inlet protection the sock must be placed around the inlet, ensuring a complete seal around it.
- The sock shall be at least the height of the kerb.

#### 9.8.4.3 Check dams

- Place a series of low sandbag check dams up the gutter from cesspits to act as a series of sediment traps. The checkdams require a spillway lower than the kerb to ensure that runoff does not encroach onto the berm area and cause scouring. Construct checkdams out of up to six sandbags laid end to end with no gaps in an arc away from the kerb and up the road to create a series of impoundment areas.

#### 9.8.4.4 Proprietary (brand) stormwater inlet protection

- A number of “off-the-shelf” products are available in the U.S. and Australia and some of these products are available in New Zealand. Please contact the appropriate local authority for approval to use any of these products.

#### Filter Sock Inlet Protection

(image provided by Erosion Control Co. Ltd.)



## 9.8.5 Construction

Consider the following when constructing stormwater inlet protection:

- Construction specifications will vary according to the type of inlet protection.

**Figure 9-16**  
**Stormwater Inlet Protection Filter Media Design**

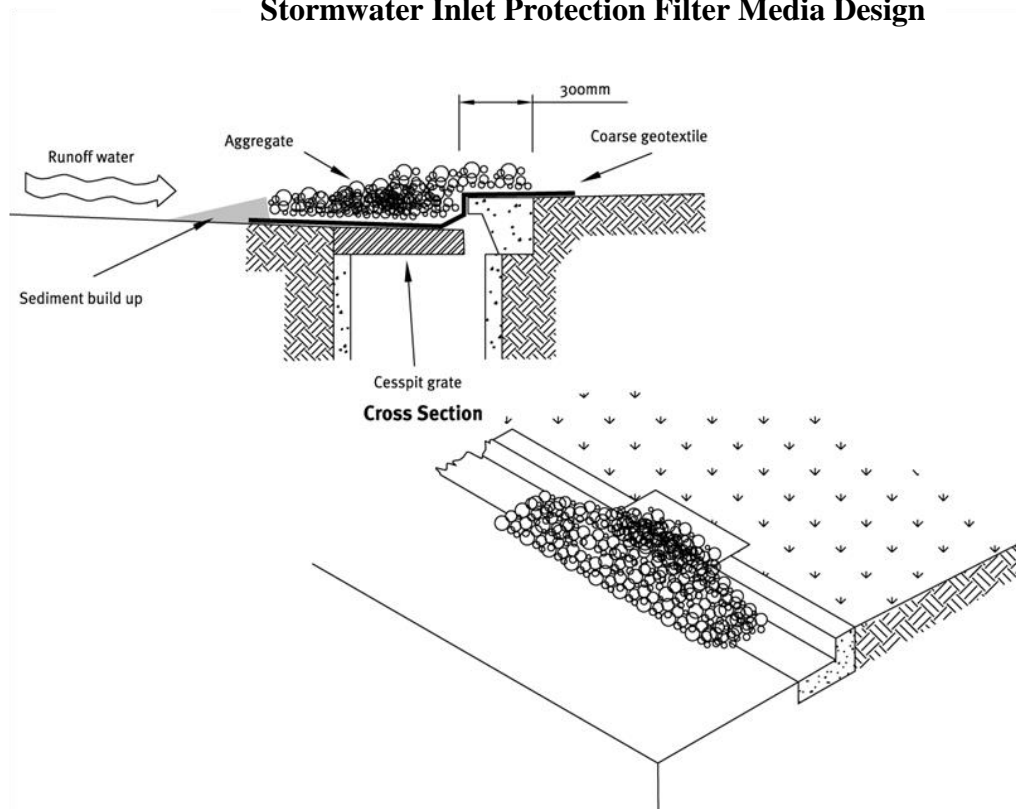

- Always ensure an emergency bypass is included on all devices. Plan for where the bypass system will divert water to.
- Ensure device does not allow water to bypass its intended flow path.
- Keep all stockpiles and loose sediment away from roadside table drains.

### 9.8.6 Maintenance

Consider the following when maintaining stormwater inlet protection measures:

- Maintenance will vary according to the type of inlet protection.
- Inspect daily and during and after rainfall events.
- Beware of blockages and leaks which may affect performance.
- Check to see if flows have been diverted away from the device and what if any damage has been caused.
- Clean all accumulated sediments immediately.
- Repair and modify any problems immediately.

### 9.8.7 Decommissioning

Consider the following when decommissioning stormwater inlet protection measures:

- Decommissioning will vary according to the type of inlet protection.

- Remove and dispose of accumulated sediments.
- Remove control measure, reuse and recycle components.
- Stabilise any disturbed areas.

## 10. Streamworks

Works in or around streams have the potential to have a direct impact on watercourse habitat (e.g. by habitat disturbance or destruction) and on watercourse ecology (such as through sediment and temperature related effects). There are also other effects such as those on amenity and modification of natural character. Note that erosion and sediment control measures are not usually constructed in channels having permanent flow. This is because the catchments are too large, the permanent flows limit the effectiveness of any controls, they can impede fish passage and they cause their own effects because of the degree of construction disturbance.

### **Culvert Construction with a Temporary Diversion Channel**



Great care is therefore required for works in and around watercourses to avoid potential effects as much as possible. Where this is unavoidable, specific control measures and methodology are required to minimise potential adverse impacts.

The following subsections set out some general information and highlight a number of ideas that can help minimise the effect of works near or in watercourses.

Works within watercourses have very high potential for erosion and discharge of sediment. This is because such work is undertaken in or near flowing water - the major cause of erosion. Flowing water causes ongoing scour and provides the transport mechanism to allow sediment to be dispersed downstream of the works and ultimately, into the marine environment.

The following erosion and sediment control methods and techniques are specific to temporary watercourse works only. Such works may also require a range of control measures additional to those discussed. These other measures are described in Section 8-10.

Design and planning consideration for a permanent watercourse crossing needs to take into account the permanent nature of the crossing in question. Permanent crossings must be constructed in accordance with all relevant requirements.



When considering temporary works in watercourses, there are a number of different activities that need to be considered.

- Temporary watercourse crossings,
- Dam and pumping or dam and diverting,
- Temporary watercourse diversions, and
- Rock outlet protection.

All of these activities impact on streams directly and indirectly through generation of sediment that can adversely impact downstream aquatic resources. Whereas sedimentation during a storm can have significant adverse impacts to aquatic organisms, sedimentation generated during low flow conditions can have devastating impacts to aquatic resources.

This Standard provides guidance for reduction in sedimentation effects for those activities discussed above. In addition, please be aware that there may be consenting issues related to streamworks and the consenting council should be contacted to ensure local requirements are met.

## 10.1 Temporary watercourse crossings

### 10.1.1 Definition and purpose

A bridge, ford or temporary structure installed across a watercourse for short term use by construction vehicles.

Temporary watercourse crossings provide a means for construction vehicles to cross watercourses without moving sediment into the watercourse, damaging the bed or channel, or causing flooding during the construction, maintenance or removal of the structure.

### 10.1.2 Conditions where practice applies

Where heavy equipment is required to be moved from one side of a watercourse to the other, or where traffic must cross the watercourse frequently for a short period of time.

### 10.1.3 Design

If a watercourse crossing is required, select a location where the potential effects of the crossing (including construction) are minimised.

### Example of an Appropriate Clean Water Diversion and Temporary Culvert While a Culvert is Being Constructed



### Bridge on a Forestry Project Constructed of Available Wood



Plan watercourse crossings well before you need them and if possible, construct them during periods of dry weather. Complete construction as rapidly as possible and stabilise all disturbed areas immediately during and following construction.

Do not build a watercourse crossing during the fish migration period for the watercourse. The Department of Conservation and Fish and Game New Zealand can help identify these periods for particular watercourses.

There are three main types of crossing:

- Bridges,
- Culverts and
- Fords.

**Temporary Bridge Crossing**

**10.1.3.1 Bridges**

Where available materials and designs are adequate to bear the expected loadings, bridges are the preferred temporary watercourse crossing method. They provide the least obstruction to flow and fish migration, cause little or no modification of the bed or banks and generally require little maintenance.



It should be noted, however, that bridges can be a safety hazard if not designed, installed and maintained appropriately. A schematic of a temporary bridge is shown in Figure 10-1.

**Figure 10-1  
Standard Configuration for a Temporary Bridge**

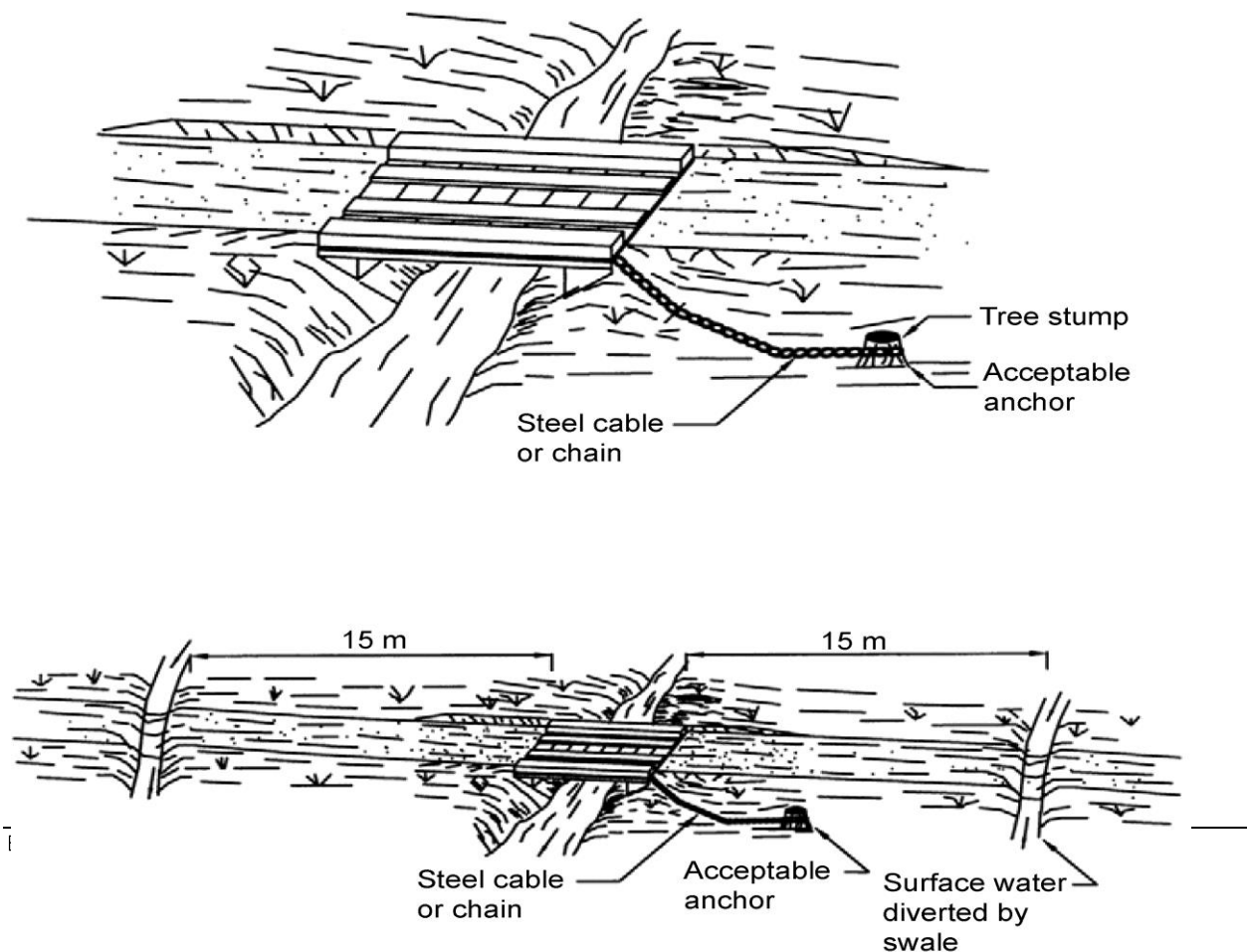

### 10.1.3.2 Culvert crossings

Culverts are the most commonly used type of temporary watercourse crossing, and can be easily adapted to most site conditions. The installation and removal of culverts, however, causes considerable damage to watercourses and can also create the greatest obstruction to flood flows and fish passage.

When installing a temporary culvert, sizing is important as storm flows could cause erosion or overtop the culvert causing failure of the temporary access. The following criteria for sizing stream crossings are provided.

- Rather than attempt to size temporary culverts through hydrological analyses, it is recommended that the cross-section of the culvert be sized for approximately 85% of the channel cross-section if the duration of the crossing is less than 1 year.
- For durations longer than one year a hydrologic design is required. Scour protection to ensure the integrity of the crossing in the event of overtopping is also required as part of the design to ensure minimal adverse impacts.
- Consideration must be given to overland flowpaths to ensure that larger flows do not cause excessive safety or environmental impacts.

A schematic of a temporary culvert is shown in Figure 10-2. Even though the culverts are temporary, they need to ensure that on perennial streams fish passage is not impeded during the period of time that the culvert is in the stream. This may involve culvert depression or velocity dissipation throughout the culvert to ensure passage.

It is important to identify whether a given activity requires local consenting and if so, to determine local requirements. Activities associated with culvert construction or maintenance need to meet the more stringent requirements.

**Temporary Culvert Crossing: Note the energy dissipation at the outfall to reduce stream erosion potential.**



**Culvert with Fish Passage Provided Through Energy Dissipation**



**Figure 10-2**  
**Standard Configuration for a Temporary Culvert**

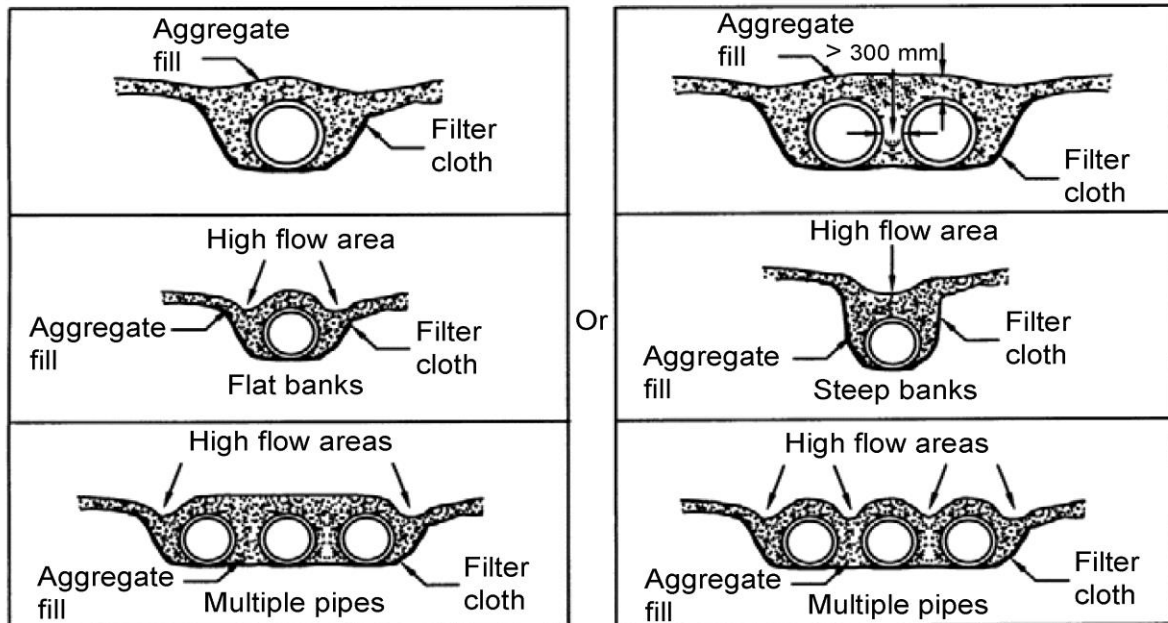
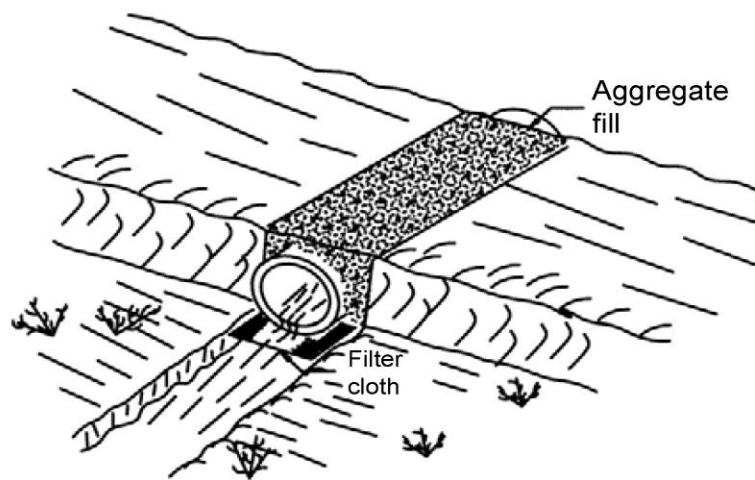

**10.1.3.3 Fords**

Made of stabilising material such as rock, fords are often used in steep catchments subject to flooding, but where normal flows are shallow. Only use fords where crossing requirements are infrequent. They can offer little or no obstruction to flows, are relatively easy to install and maintain, and in most cases can be left in place at the end of the construction activity. A schematic of a temporary ford is shown in Figure 10-3.

**Example of a Ford Crossing**



**Figure 10-3**  
**Standard Configuration for a Temporary Ford**

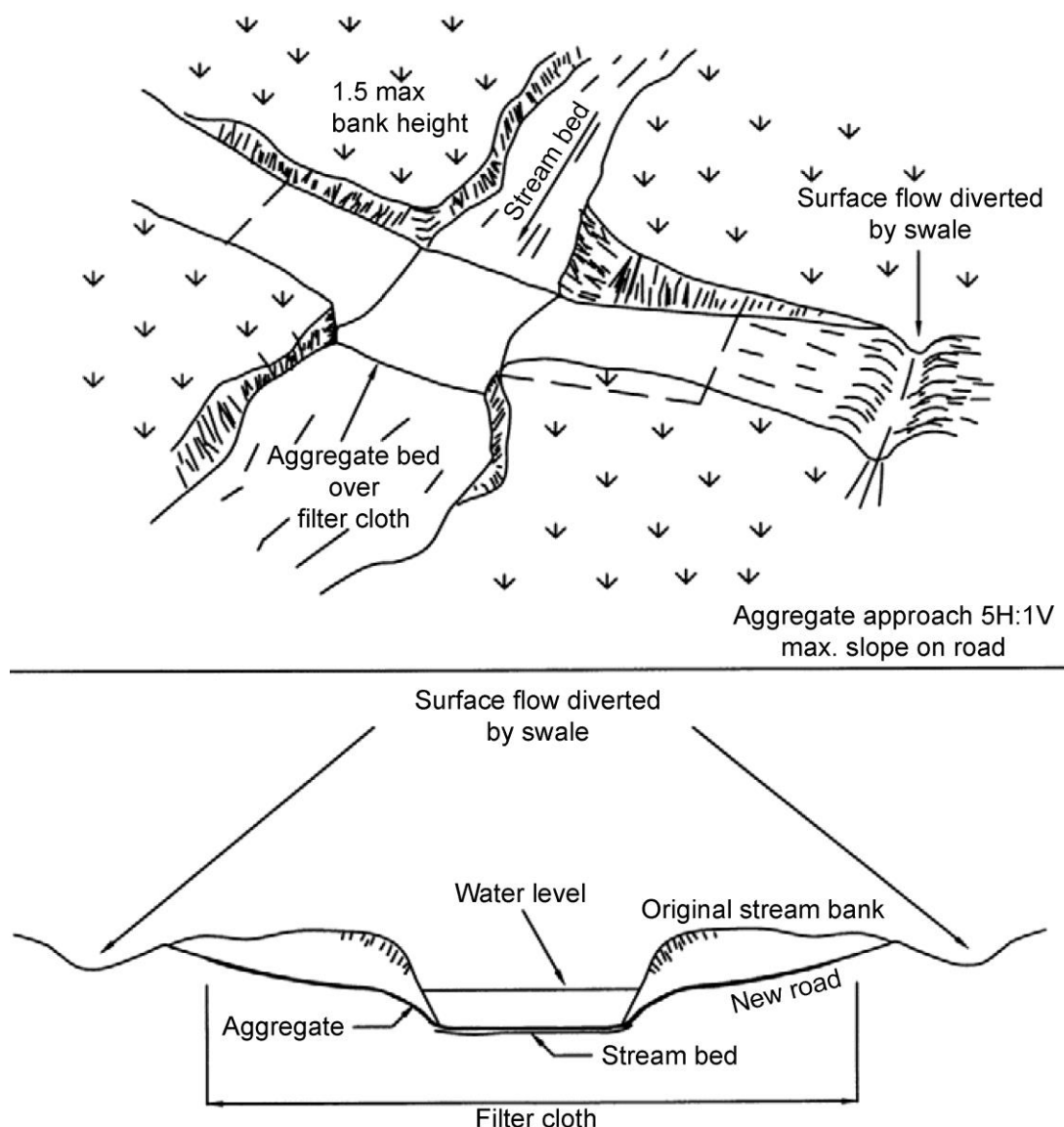

As well as erosion and sediment control measures, structural stability, utility and safety must also be taken into account when designing temporary watercourse crossings. In addition, consents may be required for the construction of the proposed crossing. This can be determined by consulting with the local authority. Any temporary crossing shall comply with the technical requirements of the consenting authority.

When the structure is no longer needed, remove the structure and all material from the site. Immediately stabilise all areas disturbed during the removal process by revegetation or artificial protection as a short term control measure. Keep machinery clear of the watercourse while removing the structure.

#### 10.1.4 Maintenance

Inspect temporary watercourse crossings after rain to check for blockage in the channel, erosion of the banks, channel scour or signs of instability. Make all repairs immediately to

prevent further damage to the installation. Permanent crossings need to be inspected following major storm events, again with all repairs being made immediately.

## 10.2 Dam and pumping or dam and diverting

### 10.2.1 Definition and purpose

A dam and pumping or a dam and diverting are temporary practices used to convey surface water from above a construction activity downstream of that activity.

There are several diversion methodologies that will assist in providing dry working conditions for culvert installation. Damming a stream and pumping the flows around the work site back to the stream minimises disturbance considerably compared with constructing a new diversion channel.

With high flow streams, diversions are sometimes the only option, however with most small streams, damming and pumping are less harmful to the environment and relatively simple to carry out. The dam is also essential to temporary waterway diversions that are discussed in the next subsection (9.3.2).

Water Being Diverted Past a Construction Site



### 10.2.2 Design

A dam is constructed across the stream (upstream and downstream of the in stream works) with stabilised materials such as sand bags, large rock with geo-textile support or other suitable construction materials. A pump is installed in the dam and sufficient hose length must be available to reach below the extent of in stream works. The pump inlet should be placed in a drum with holes to minimise the possibility of sucking sediment from the bottom of the dam. The outlet should be directed to a stabilised area with an energy dissipater such as riprap boulders or similar. Figure 10-4 provides a schematic of a temporary waterway diversion dam.

Sizing of the channel for a given storm event depends on the duration of the stream diversion. If the duration of the diversion is less than 30 days, the temporary channel should be sized for a 2-year peak discharge. If the diversion is for greater than 30 days but less than 60 days, the channel should be sized for a 10-year peak discharge. Projects having a duration greater than 60 days should have the channel sized for a 20-year peak discharge.

#### *Construction Notes:*

- (a) The dam must be capable of holding back the incoming flows.
- (b) The pump should be capable of conveying the flows, as overtopping the dam will cause problems when laying compacted base material for the new culvert.

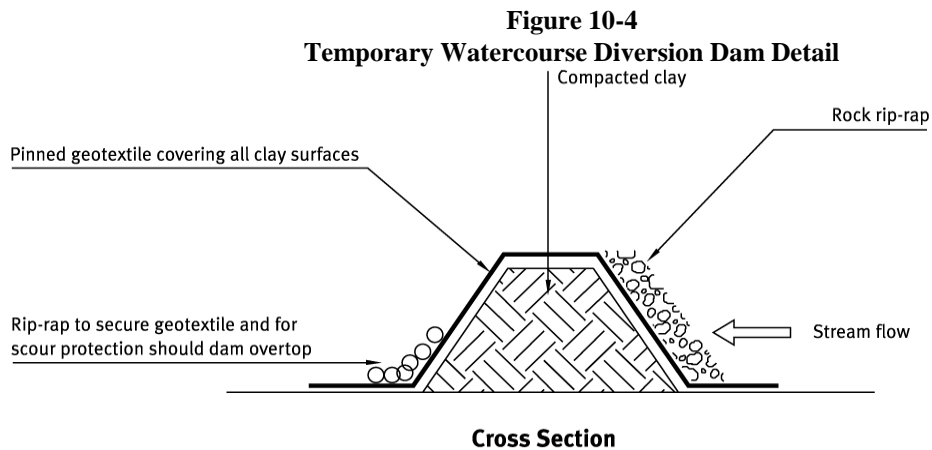

## 10.3 Temporary waterway diversions

### 10.3.1 Definition and purpose

A short term watercourse diversion that allows work to occur within the main watercourse channel under dry conditions.

Temporary waterway diversions enable in stream works to be undertaken without working in wet conditions and without moving sediment into the watercourse.

Alternative measures such as using marine ply are also available.

**Waterway Diversion on a Highway Project**



**Temporary Culvert Stream Diversion**



### 10.3.2 Conditions where practice applies

Temporary watercourse diversions are used as temporary measures to allow any works to be undertaken within permanent and ephemeral watercourses.

### 10.3.3 Design

Divert all flow via a stabilised system around the area of works and discharge it back into the channel below the works to avoid scour of the channel bed and banks. Figures 10-5 to 10-8 show the suggested steps to minimise sediment generation and discharge from works within a watercourse.

- **Step 1**

The diversion channel should be excavated leaving a plug at each end so that the watercourse does not breach the diversion. Size the diversion channel to allow for a 5% AEP rain event using the methodology outlined in Section 6. The diversion channel should be appropriately stabilised to ensure it does not become a source of sediment. Suitable geotextile cloth (as discussed in Section 8.3.5) should be anchored in place to the manufacturer's specifications, which will include trenching into the top of both sides of the diversion channel to ensure that the fabric does not rip out. The downstream plug is then opened to allow water to flow up the channel, keeping some water within the channel to reduce problems when the upstream plug is excavated. Open the upstream plug and allow water to flow into the channel.

- **Step 2**

A non-erodible dam shall be immediately placed in the upstream end of the existing channel. The dam shall be constructed as specified in Figure 10-4, where a compacted earth bund has shotcrete/ concrete placed, or appropriate geotextile pinned over it, with rock rip-rap extending over the upper face and adjacent to the lower face for scour protection.

- **Step 3**

A non-erodible downstream dam shall then be installed to prevent backflow into the construction area. The existing watercourse is then drained by pumping to a sediment retention pond where treatment of the ponded water can

**Figure 10-5**  
Diversion Channel Prior to Plug Removal

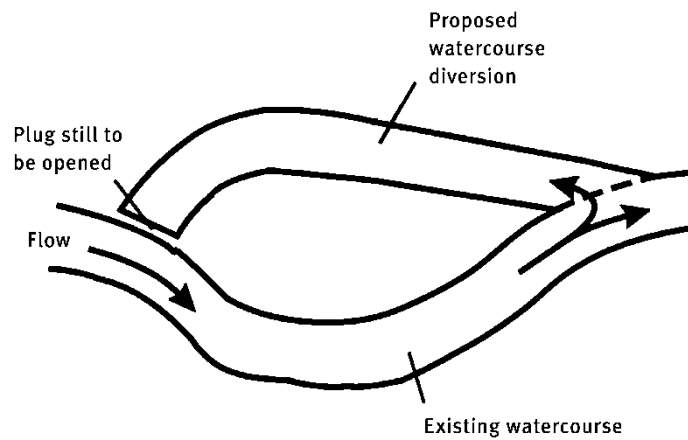

**Figure 10-6**  
Opening Up Bypass Channel and Closing off Existing One

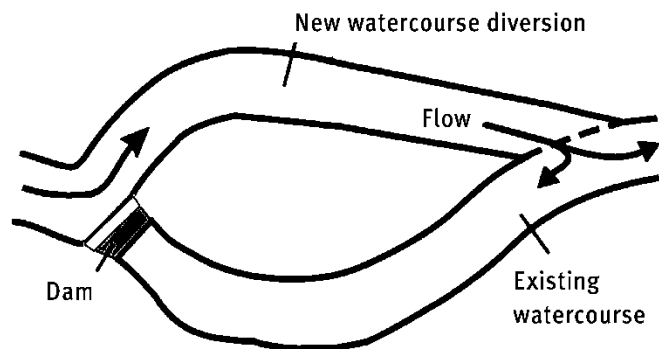

**Figure 10-7**  
Dewatering Construction Area into a Sediment Pond

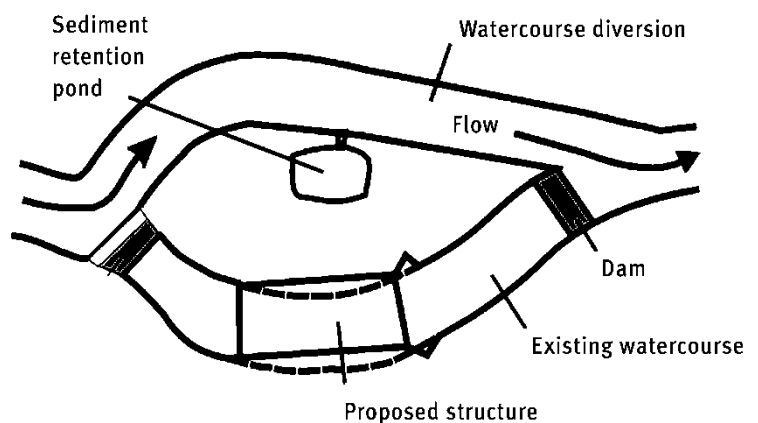



occur prior to re-entering the live section of the watercourse. Construct the structure and complete all channel work.

If there are fish trapped in the existing watercourse as a result of the diversion, those fish should be captured and relocated to the live section of the watercourse.

- **Step 4**

The downstream dam should be removed first, allowing water to flood back into the original channel. The upstream dam is then removed and filled in both ends of the diversion channel with non-erodible material. Any sediment-laden water should be pumped to a sediment retention pond. The remainder of the diversion channel should be filled in and stabilised.

**Figure 10-8**  
Re-establishment of Flow in Original Channel

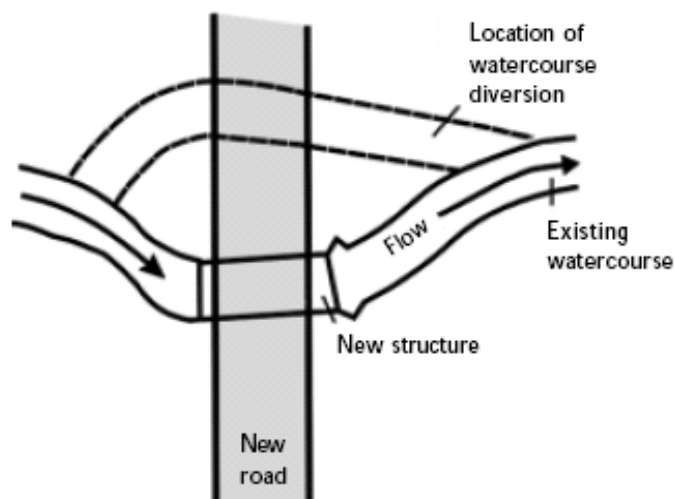

### 10.3.4 Maintenance

Any works within a watercourse will require ongoing and vigilant maintenance to minimise sediment generation. To achieve this, identify and correct any signs that may indicate a potential problem. Take particular notice of the following signs.

- The geotextile lining ripping, or
- Scour occurring where the flow re-enters the channel, or
- Undercutting of the diversion lining, and
- Make repairs immediately.

## 10.4 Instream and near stream works

Instream and near stream works relate to temporary structures built within the banks or channel of a waterway to enclose a construction area and reduce sediment delivery from work in or immediately adjacent to the waterway. The structures may be made of rock, sand bags, wood or a filled geotextile material.

### 10.4.1 Design

Instream and near stream works may be used in construction activities such as streambank stabilisation, culvert installation, bridges, piers or abutments. It may be used in combination with other practices such as clean water diversion or pumping. The various options available to isolate construction on banks or in channels are shown in Figure 10-9 that is modified from the State of Oregon Department of Environmental Quality Erosion and Sediment Control Manual, April 2005.

**Use of Marine Ply as a Stream Diversion Approach**



## 10.4.2 Construction

When used in a waterway, cofferdams must be used in accordance with any consenting requirements. Materials should be selected based on ease of maintenance and complete removal following completion of construction.

## 10.4.3 Maintenance

- Inspect every day during construction,
- Conduct additional inspections during higher stream flows associated with runoff events,
- Immediately repair any gaps, holes or scour,
- Upon construction completion remove any sediment that has been captured,
- Remove structure, and
- Revegetate disturbed areas if applicable.

**Figure 10-9**  
**Various In and Near Stream Sediment Control Practices**

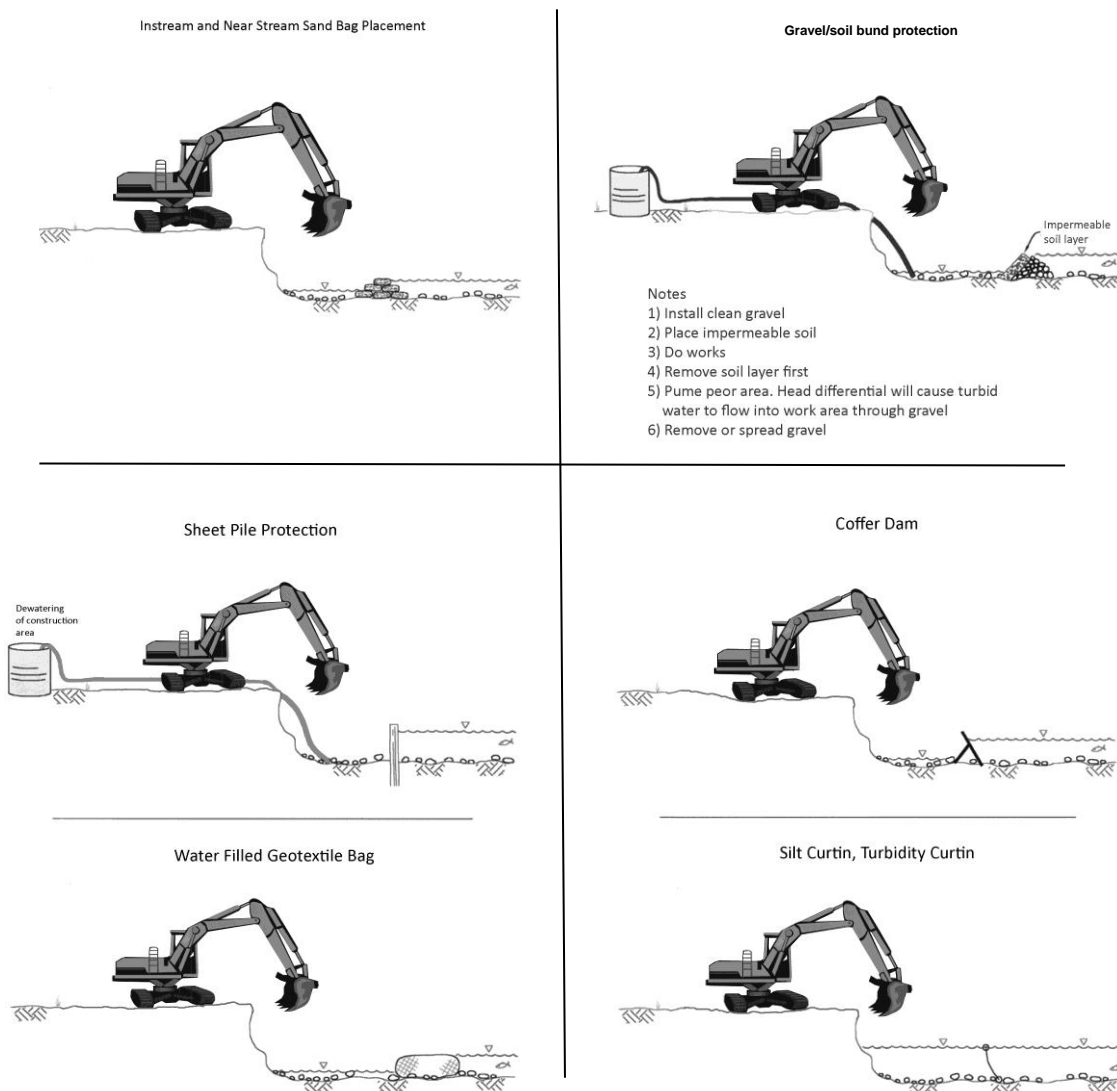

## 11. Variations and new product approach

In the context of land disturbing activities, the overarching goal is to minimise sediment discharges to receiving environments by the utilisation of erosion and sediment controls. The practices outlined in Section 8 and 9 provide for a comprehensive selection of available and known techniques, with demonstrated effectiveness established over time.

Advances in the understanding of practices and procedures within the earthworks industry is an iterative process whereby a “good idea” may, at a later date, become standard practice on earthworks sites. This is a reflection of the evolving nature of the erosion and sediment control field and therefore presents an opportunity for innovative practices which have not been already identified within this guideline. These innovative practices may be very suitable where site constraints make it difficult to achieve the desired water quality treatment levels with conventional systems. Accordingly, a new technology may provide a level of treatment that is not possible with conventional approaches.

Innovative practices tend to be new technologies that have not been evaluated using approved protocols, but for which preliminary data indicate that they may provide a desirable level of treatment. The Transport Agency encourages the development of innovative, cost-effective erosion and sediment controls and management technologies, subject to the necessary endorsement. This endorsement will depend on a number of factors but largely on the submission of objective and verifiable data that supports the claimed efficiency and effectiveness of the measure. Note that this endorsement will likely require the approval of the specific local authority.

Due to the nature of state highway construction, some variations from the approaches set out in this guide may be appropriate. Whenever a variation is required, the variation shall be endorsed by the Transport Agency. The Transport Agency Environment and Urban Design Team are available to assist project teams in evaluating the variation or new product.

### 11.1 Proposed process of endorsement

When seeking endorsement to use an erosion and sediment control practice not outlined in this guide, the Transport Agency requires the following basic information to be submitted to ensure consistency in the evaluation approach.

It is recognised that comparing the performance of different products and techniques can be difficult, as test procedures/protocols are not always consistent. In this sense, the following product information for product endorsement provides a framework for their assessment.

Accordingly, any new product/practice proposed for endorsement should provide the following information:

- A representative product sample (if practicable).
- Key background information which contains details on:
  - Product specifications;
  - Literature review;
  - Process by which sediment is removed (filtering, sedimentation, flocculation)
  - Installation references;
  - Field performance and laboratory test data (e.g. how does the device work under a particular storm? Has the device been compared to other existing devices? What soil type was the product tested with?);

- Potential impacts on pH (if appropriate);
- Proposed monitoring data (this may be necessary if field data is limited) for at least three sites having a variety of soil conditions (sand, silt, clay, pumice) to include:
  - Soil conditions;
  - Slope;
  - Storm event analysis;
  - Catchment area served;
  - Percentage of catchment area without ground cover;
  - Field data (not laboratory-based) for at least 5 storms with one storm being greater than 20 mm of rainfall;
  - Composite samples (inlet and outlet);
  - Expected sediment removal efficiencies for each event and total efficiency for all monitored events;
  - Monitoring of turbidity (Appendix B has sampling protocol);
  - Monitoring protocols/standards (grab sample, automatic sampler, flow or time activated, depth of sample collection, etc.);
  - Laboratory analysis.
- Names of any other companies/agencies that are testing the product, and notifications of completed tests and/or product approval.
- Letters of endorsement from Local Authorities (if received).
- Documentation and/or discussion of potential causes of poor performance or failure of the practice.
- Key design, installation and maintenance specifications or considerations.
- Health and safety considerations.
- Estimated cost.

## **11.2 New product acceptance**

The Transport Agency is responsible for the acceptance of new products. Project teams need to discuss the approval of a new product or approach with the Transport Agency Environment and Urban Design Manager before they adopt new practices. The purpose of this process is to ensure consistency in the use of the guidelines and that the Transport Agency is kept aware of changing practices so this guideline can be updated in due course. An important benefit of this approach is that it provides an opportunity for the Transport Agency to monitor the effectiveness of a new practice.

It may still be necessary to receive approval from the consenting authority of a new product when the erosion and sediment control plans are submitted.

---

## References

Auckland Regional Authority, Review, Sediments of the Upper Waitemata Harbour, Upper Waitemata Harbour Catchment Study, 1983.

Auckland Regional Council, Review of Erosion and Sediment Control Management Options Relating to Staging and/or Length of the Earthworks Season by Erosion Management Ltd and Environmental Services Ltd, June 2003. *Internal review to the Auckland Regional Council.*

Auckland Regional Council, Erosion & Sediment Control Guidelines for Land Disturbing Activities in the Auckland Region, Technical Publication No. 90, March 1999.

Auckland Regional Council, Low Impact Design Manual for the Auckland Region, Technical Publication No. 124, April 2000.

Australian and New Zealand Environment and Conservation Council, Australian and New Zealand Guidelines for Fresh and Marine Water quality, National and Water Quality Management Strategy, 2000

Babington and Associates Ltd., Decanting Earth Bund Efficiency Trial, April 2008 with amendments September 2008.

Babington & Associates Ltd (2001) - *internal report to Environment Bay of Plenty.*

Barfield, B., Analysis of the Effects of Existing and Alternative Design Criteria on the Performance of Sediment Detention Ponds, 1986 Sediment and Stormwater Conference, Salisbury, Maryland, July 1986.

Barrett, M.E., Malina, J.F., Charbeneau, R.J., Ward, G., Effects of Highway Construction and Operation on Water Quality in an Ephemeral Stream in the Austin, Texas Area, Center for Research in Water Resources, University of Texas, 1995.

Barrett, M.E. et al, An Evaluation of the Use and Effectiveness of Temporary Sediment Controls, Technical Report CRWR 261, The University of Texas at Austin, Center for Research in Water Resources, Austin Texas, 1995.

Carter, V.G., Dale, T., Topsoil and Civilization, Revised edition, University of Oklahoma Press, first edition 1955, revised edition 1974.

California Department of Transportation, Caltrans Stormwater Quality Handbooks - Construction Site Best Management Practices Manual (March 2003).

Caltrans, Project Planning and Design Guide, Construction Site Best Management Practices (BMPs) Guide, Storm Water Quality Handbooks, State of California Department of Transportation, September 2002.

Clapcott, J.E., et. al, Sediment Assesment Methods: Protocols and guidelines for assessing the effects of deposited fine sediment on in-stream values, Cawthron Institute, Nelson, New Zealand, 2011.

Claytor, R., Practical Tips for Construction Site Phasing, Watershed Protection Techniques 2(3), 1997.

Dane County, Dane County Erosion Control and Stormwater Management Manual, 2007.

Department of Environment and Climate Change NSW, Managing Urban Stormwater - Soils and Construction, Volume 2D Main Road construction, June 2008

EPA Victoria, Environmental Guidelines for Major Construction Sites (480), February 2006

Environment Bay of Plenty, Erosion and Sediment Control Guidelines for Land Disturbing Activities, September 2001.

Environment Canterbury, Erosion and Sediment Control Guideline 2007: A better way of managing earthworks and the environment, 2007.

Environment Waikato, Erosion and Sediment Control - Guidelines for Soil Disturbing Activities” (Technical Report No.2002/01), January 2009.

Fifield, J., Designing Effective Sediment and Erosion Control for Construction Sites, Forester Press, Santa Barbara, California, 1999.

Fox, H., Effects of Urbanization on the Patuxent River, with Special Emphasis on Sediment Transport, Storage and Migration, Degree of Doctor of Philosophy, Johns Hopkins University, Baltimore Maryland, 1974.

Gibbs, M., Hewitt, J., Effects of sedimentation on macrofaunal communities: a synthesis of research studies for ARC, NIWA, prepared for Auckland Regional Council, Technical Publication No. 264, May 2004.

Gibbs, Max, Sediment Source Mapping in Mahurangi Harbour, NIWA Client Report for Auckland Regional Council, Technical Publication No. 321, June 2006.

Georgetown County, Storm Water Management Design Manual, November 2006.

Goldman, S.J., Jackson, K., Bursztynsky, T.A., Erosion and Sediment Control Handbook, McGraw-Hill Book Company, 1986.

Greater Wellington Regional Council, Erosion and Sediment Control Guidelines for the Wellington Region, September 2002.

Hawke’s Bay Regional Council, Land Management, Sustainable Land Management, Wind Erosion and Control, Environmental Topics, June 2002.

Harding, M.V., Erosion Control Effectiveness: Comparative Studies of Alternative Mulching Techniques, Environmental Restoration pp 149-156, 1990.

Hawke’s Bay Regional Council, Hawke’s Bay Waterway Guidelines, Erosion and Sediment Control, April 2009.

Hicks, Murray, Storm Sediment Yields from Basins with Various Lanuses in Auckland Area, prepared for Auckland Regional Council, NIWA, July 1994.

Kayhanian, M., Murphy, K., Regenmorter, L., Haller, R., Characteristics of Stormwater Runoff from Highway Construction Sites in California, Transportation Research Record 1743, Paper No. 01-3181, National Academy Press,

Kouwen, N., Silt Fences to Control Sediment on Construction Sites, Technical Publication MAT-90-03, Ontario Ministry of Transportation, Research and Development Branch, Downsview, Ontario, Canada, 1990.

Kuichling, E.m, The Relation Between Rainfall and the Discharge of Sewers in Populous Districts, Transactions of ASCE, Volume 20, pp 1-56, 1889.

Larcombe, M., Summary of Sediment Retention Pond Performance, Mass Discharges of Sediment to the Orewa Estuary Receiving Environment and Effects of Sediment Discharge to the Orewa

Estuary for the 2008-2009 Earthworks Season, Report submitted to ARC for a sediment control consent, June 2009.

Lohrer, A.M., Thrush, S.F., Hewitt, J.E., Berkenbusch, K., Ahrens, M., Cummings, V.J., Terrestrially derived sediment: response of marine macrobenthic communities to thin terrigenous deposits, Marine Ecology Progress Series, Volume 273: 121-138, 2004.

Land Transport Management Act 2003

Maryland Department of the Environment, 2010 Maryland Standards and Specifications for Soil Erosion and Sediment Control, Draft guidelines, October 2009.

Ministry for the Environment, Economic Instruments for Managing Water Quality in New Zealand – January 2004.

Moore, J., Pattinson, P., Performance of a Sediment Retention Pond Receiving Chemical Treatment, prepared for Auckland Regional Council, NIWA, July 2008.

National Environmental Standard for Assessing and Managing Contaminants in Soil to Protect Human Health

National Policy Statement for Freshwater Management

NIWA, Sediment Loadings from the Proposed Countryside Living Zone, prepared for ARC, 1997.

North Shore City Council, Long Bay Structure Plan: Hydrological Analysis, Final Report, Beca Steven, Document Reference LDP99R01.DOC, 27 September 1999.

NZ Transport Agency, Environmental and Social Responsibility Standard, June 2014

NZ Transport Agency, Environmental and Social Responsibility Policy, 2012

NZ Transport Agency, Environmental Plan: Improving Environmental Sustainability and Public Health in New Zealand, Version 2, June 2008.

NZ Transport Agency, Guide to assessing air quality effects for state highway asset improvement projects, Version 0.6, September 2012, DRAFT

NZ Transport Agency, Guideline for preparing an Environmental and Social Management Plan, April 2014

NZ Transport Agency, Guideline for Highway Landscaping, 2014

Resource Management Act 1991

RST Environmental Solutions, Dust Control: Environmental Solutions Suited to New Zealand Conditions, 2014, [www.rst.co.nz/dust-control.html](http://www.rst.co.nz/dust-control.html)

Park, S., Bay of Plenty Marine Sediment Contaminants Survey, Environment Bay of Plenty, Environmental Publication 2009/01, January 2009.

Parkyn, S., Wilding, T., Croker, G., Small Headwater Streams of the Auckland Region Volume 4: Natural Values, prepared for Auckland Regional Council, NIWA Client Report HAM2006-134, August 2006.

Pitt, R.E., Clark, S.E., Lake, D.W., Construction Site Erosion and Sediment Controls: Planning, Design and Performance, DEStech Publications, Lancaster Pennsylvania, 2007.

Platts, W.S. et.al., Changes in Salmon Spawning and Rearing Habitat from Increased Delivery of Fine Sediment to the South Fork Salmon River, Idaho, Transactions of the American Fisheries Society, 118; 274-283, 1989.

Rowell, David, Soil Science: Methods and Applications, Longman Scientific and Technical publishers, Longman Group UK Limited, 1994.

Senior, A., et.al, Risks to Estuarine Biota under Proposed Development in the Whitford Catchment, prepared by NIWA for Manukau City Council and Auckland Regional Council, Technical Publication #205, August 2003.

Shaver, Water Quality Effluent Standards and their Applicability to Environment Bay of Plenty Stormwater Discharge Consents, Aqua Terra International Ltd, 2009.

Springer, G.,S., Erosion by Liquid Impact, Scripta Pub., John Wiley and Sons, New York, 1976.

State of Delaware, Delaware Erosion and Sediment Control Handbook, December 2003.

Sunshine Coast Regional Council, Erosion and Sediment Control Manual (Version 1.2), November 2008.

Swales et.al, Evidence for the Physical Effects of Catchment Sediment Runoff Preserved in Estuarine Sediments: Phase II (field study), NIWA and Landcare Research Ltd., prepared for Auckland Regional Council, Technical Publication No. 221, December 2002.

Swales A., et. al., Whaingaroa (Raglan) Harbour: Sedimentation Rates and the Effect of Historical Catchment Landcover Changes, prepared for Environment Waikato, NIWA Client Report: HAM2005-070, August 2005.

Te Ara Encyclopedia of New Zealand, Lakes, Lake Processes, Sediment in Lakes.

Thompson, C., S., High Intensity Rainfall Design System (HIRDS), version 2, NIWA, June 2002.

Townsend, M., Lundquist, C., Halliday, J., Central Waitemata Harbour Ecological Monitoring: 2000-2008, Prepared by NIWA for Auckland Regional Council, Auckland Regional Council Technical Report 2008/017, 2008.

United States Environmental Protection Agency, Guidance Specifying Management Measures for Sources of Nonpoint Pollution in Coastal Waters, EPA 840-B-92-002, United States Environmental Protection Agency, Office of Water, Washington DC, 1993.

United States Environmental Protection Agency, Environmental Impact and Benefits Assessment for Proposed Effluent Guidelines and Standards for the Construction and Development Category, USEPA, Office of Water, EPA-821-R-08-009, November 2008.

Urich, P., B., Land Use in Karst Terrain: Review of Impacts of Primary Activities on Temperate Karst Ecosystems, Department of Conservation, Science for Conservation 198, June 2002.

Vant, W. N., et. al., Effects of Future Urbanisation in the Catchment of Upper Waitemata Harbour, NIWA Consultancy Report No. ARC220R done for ARC, June 1993.

Water and Rivers Commission, Water Notes: Advisory notes for land managers on river and wetland restoration, WN17, July 2000.

Williamson, R.R., Urban Runoff Data Book: a manual for the preliminary evaluation of urban stormwater impacts on water quality, Water Quality Centre Publication No. 20, NIWA, 1993.

Wischmeier, W.H., Smith, D.D., Predicting Rainfall Erosion Losses – A Guide to Conservation Planning, U.S. Department of Agriculture, Agricultural Handbook No. 537, 1978.



Zhu, J., Dabney, S.M., Flannagan, D.C., Updating Slope Topography During Erosion Simulations with the Water Erosion Prediction Project.

# Appendix A

## Glossary

**AEP (Annual exceedance probability):** a statistical term defining the probability of an event occurring annually. Expressed as a percentage and generally used in hydrology to define rainstorm intensity and frequency. For example, a five percent AEP event has a five percent chance of being exceeded in any one year. This has replaced the return period concept. A five percent AEP event expresses the twenty year return period in more probability terms.

**Anti-seep collar:** an impermeable barrier, usually of concrete, constructed at intervals within the zone of saturation along the conduit of a primary outlet pipe to increase the seepage length along the conduit and, thereby prevent piping or seepage in the compacted fill material along the outside of the pipe.

**Area of disturbance:** the area of soil exposed as a result of the development process.

**ARI (average recurrence interval):** the average period between exceedance of a given rainfall or flow rate.

**Baffles:** semi-permeable or solid barriers placed in a sediment retention pond to deflect or regulate flow and effect a more uniform distribution of velocities, hence creating better settling conditions.

**Batter:** a constructed slope of uniform gradient.

**Berm:** in this guideline, berm usually means a small earthen bank, rather than roadside berm.

**BPO: best practicable option.** In relation to a discharge of a contaminant, BPO means the best method for preventing or minimising the adverse effects on the environment having regard, among other things, to:

- (1) The nature of the discharge or emission and the sensitivity of the receiving environment to adverse effects;
- (2) The financial implications, and the effects on the environment, of that option when compared with other options; and
- (3) The current state of technical knowledge and the likelihood that the option can be successfully applied.

**Bulk earthworks:** this term is generally used to describe the cut to fill earthworks required to re-grade an area. It also applies to larger-scale earthworks such as for building excavations.

**Catchment:** a geographical unit within which surface runoff is carried under gravity by a single drainage system to a common outlet or outlets. Also commonly referred to as a watershed or drainage basin.

**Catchpit:** small chamber incorporating a sediment trap that runoff flows through before entering a reticulated stormwater system (also termed a sump).

**Channel:** that part of a watercourse system where normal flow is contained. The channel is generally incised into the floodplain and for many of the stable stream systems in New Zealand can be defined in capacity as being just able to accommodate the annual return period flow (one hundred percent AEP) without overtopping. Also refers to an artificial conduit such as a ditch excavated to convey water.

**Channel stabilisation:** stabilisation of the channel profile by erosion control and/or velocity distribution through reshaping, the use of structural linings, mass blocks, vegetation and other measures.

Channel storage: the amount of water temporarily stored in channels while en route to an outlet.

Chute: see Flume.

Clay (soils): a mineral soil consisting of particles less than 0.002mm in equivalent diameter. A soil texture class.

Clean water: any water that has not been polluted by construction activities and has no visual signs of suspended solids, e.g. overland flow (sheet or channelled) originating from stable well-vegetated or armoured surfaces.

Cohesion: the capacity of a soil to resist shearing stress, exclusive of functional resistance.

Cohesive soil: a soil that, when unconfined, has considerable strength when air-dried and significant cohesion when submerged.

Compaction: for construction work in soils, engineering compaction is any process by which the soil grains are rearranged to decrease void space and bring them into closer contact with one another, thereby increasing the weight of solid material per unit of volume, increasing their shear and bearing strength and reducing permeability.

Concentrated flow: the accumulation of sheet flow into discrete rills, gullies or channels, significantly increasing erosive forces.

Conduit: any channel intended for the conveyance of water, whether open or closed.

Contaminant: includes any substance (including gases, liquids, solids, and micro-organisms) or energy (excluding noise) or heat, that either by itself or in combination with the same, similar, or other substances, energy, or heat:  
(a) when discharged into water, changes or is likely to change the physical, chemical, or biological condition of water; or  
(b) when discharged onto or into land or into air, changes or is likely to change the physical, chemical, or biological condition of the land or air onto or into which it is discharged.

Contour: a line across a slope connecting points of the same elevation.

Contributing drainage area: all of that drainage area that contributes to the flow into a treatment device. A contributing drainage area can include both clean and sediment-laden water flows. Commonly referred to as the catchment area.

Crimping: the embedding of straw mulch into the soil surface by using implements such as a disc cultivator set at zero cut.

Critical twenty year return period storm: a rainfall event that has a five percent annual exceedance probability and a duration equal to the time of concentration.

Cumulative effect: the combination of discrete isolated effects, the sum of which can have a major long-term detrimental impact.

Dam: a barrier to confine or raise water for storage or diversion, to create a hydraulic head, to prevent gully erosion, or to retain soil, rock or other debris.

Decant rate: the rate at which surface water is decanted from a sediment retention pond.

Deposition: the accumulation of material that has settled because of reduced velocity of the transporting agent (water or wind).

Detention dam: a dam constructed for the temporary storage of storm flow, which releases the stored water at controlled rates in order to reduce flooding hazard downstream of the dam.

Dewatering: the removal of impounded water, generally by pumping.

Di-ammonium phosphate (DAP): a high-percentage nitrogen and phosphate fertiliser suitable for the rapid establishment of grass.

Disturbed area: an area of exposed soil.

**Diversion:** a channel or bund constructed to convey concentrated flow.

**Drainage:** the removal of excess surface water or groundwater from land by means of surface or subsurface drains.

**Drainage basin:** refer catchment.

**Ephemeral watercourse:** a watercourse that flows only part of the year; includes overland flowpaths such as grassland swales and dry gullies which only flow during more intensive rainstorms.

**Erodible:** an erodible soil is a soil that is readily entrained (moved) by actions such as raindrop impact, overland flow or wind.

**Erosion and sediment control plan:** a detailed plan normally prepared by the developer's engineer that details the way erosion is to be minimised and the treatment of sediment-laden overland flow that is to be undertaken.

**Erosion-control blankets:** manufactured blankets and matting of either synthetic or natural fibre used to minimise surface erosion by protecting soil from raindrop impact and shallow sheet flows. Similar to but lighter and less durable than erosion-control mats (see below).

**Erosion-control matting:** manufactured matting of either synthetic or natural fibre used to minimise surface erosion by concentrated flows and, in some cases, to promote revegetation.

**Erosive power:** refers to the ability of erosional agents such as wind or water to cause erosion. Not to be confused with erodible, as a quality of soil.

**Erosive velocities:** velocities that are high enough to wear away the land surface. Exposed soils erode faster than stabilised soils. Erosive velocities vary according to the soil type, slope, and structural or vegetative stabilisation used to protect the soil.

**Estuary:** area where freshwater meets salt water, where the tide meets the river current (e.g. bays, mouths of rivers, salt marshes and lagoons). Estuaries serve as nurseries and spawning and feeding grounds for large groups of marine life and provide shelter and food for birds and wildlife. Estuaries are typically low energy systems where sediment readily settles.

**Evapotranspiration:** the sum of surface evaporation and plant transpiration.

**Emergency spillway:** a sediment retention pond or dam spillway designed and constructed to discharge flow in excess of the structure's primary spillway design discharge.

**Energy dissipator:** a designed device such as an apron of rip-rap or a concrete structure placed at the end of a water conduit such as a pipe, paved ditch or flume for the purpose of reducing the velocity and energy of the discharged water.

**Fill:** earth placed (normally under a strict compaction regime) to raise the land surface.

**Filter blanket:** a layer of sand and/or gravel designed to prevent the movement of fine-grained soils.

**Filter fabric:** a woven or non-woven, water-permeable geotextile made of synthetic products such as polypropylene used for such purposes as preventing clogging of aggregate by fine soil particles. Refer Geotextile fabric.

**Filter strip:** a long, narrow vegetative planting used to retard or collect sediment for the protection of adjacent properties or receiving environments.

**Fines (soil):** generally refers to the silt- and clay-size particles in soil.

**Flocculation:** the process whereby fine particles suspended in the water column clump together and settle. In some instances, this can occur naturally, such as when fresh clay-laden flows mix with saline water, as occurs in estuaries. Flocculation can be used to promote rapid settling in sediment retention ponds by the addition of flocculating chemicals (flocculants).

- Flume:** a high-velocity, open channel for conveying water to a lower level without causing erosion. Also referred to as a chute, although, technically, a chute is part of a flume; namely, the steeply inclined section of a flume or other similar hydraulic structure, between the inlet and the outlet, that conveys flows directly from one level to another.
- Gabion basket:** a flexible woven-wire basket comprising: two to six rectangular cells filled with small stones. Gabions may be assembled into many types of structures, such as retaining walls, channel liners, drop structures and groynes.
- Geosynthetic erosion control systems (GECS):** the artificial protection of erodible channels and slopes using artificial erosion control material such as geosynthetic matting, geotextiles or erosion matting. Also see Erosion-control blankets and Erosion-control matting in section 6.2.3.
- Geotextile fabric:** a woven or non-woven, impermeable or semi-permeable material generally made of synthetic products such as polypropylene and used in a variety of engineering, stormwater management, and erosion and sediment control applications.
- Gley soils:** formed under the influence of poor drainage, gley soils are typically grey or blue-grey in colour, sometimes with reddish-brown iron deposits.
- Grade:**
- (1) The slope of a road, channel or natural ground.
  - (2) The finished surface of a channel bed, road bed, top of embankment or bottom of excavation.
  - (3) Any surface prepared for the support of construction like paving or for laying conduit.
  - (4) To finish the surface of a channel bed, road bed, top of embankment or bottom of excavation.
- Gravel:** aggregate consisting of mixed sizes of 5mm to 75mm particles which normally occur in or near old streambeds and have been worn smooth by the action of water.
- Guar:** a drought-tolerant herb grown for forage and for its seed, which yields a gum used as a thickening agent or sizing material. This biodegradable gum can be used as a tackifier, or an adhesive applied directly to the soil, or over a layer of mulch. It acts as a glue to hold the soil in place or increase the holding power of the mulch.
- Headwater:** the source of a watercourse; the water upstream of a structure or point on a watercourse.
- Hydrology:** the science of the behaviour of water in the atmosphere, on the surface of the earth and underground.
- Hydroseeding:** the pressure-spraying of a slurry of water, seed, fertiliser and paper or wood pulp over a surface to be revegetated.
- Impervious:** not allowing infiltration of water.
- Level spreader:** a device used to convert concentrated flow into sheet flow.
- Mitigation:** measures taken to off-set adverse environmental effects.
- Mulch:** covering on surface of soil to protect it and enhance certain characteristics, such as protection from raindrop impact and improving germination. Mulching can be extended to include gravelling of compound areas, haul roads and access tracks.
- Overland flow path:** the route of concentrated flow.
- Perennial stream:** a stream that maintains water in its channel throughout the year or maintains a series of discrete pools that provide habitats for the continuation of the aquatic ecosystem.
- Permeability (soil):** the rate at which water will move through a saturated soil.

**Permitted activities:** activities described in the Resource Management Act, regulations, or a plan or proposed plan that does not require a resource consent if it complies with the standards, terms, or conditions, if any, specified in the plan or proposed plan.

**Pervious:** allowing movement of water.

**Poly aluminum chloride (PAC):** a long chain chemical that is used as a flocculent in certain situations.

**Primary spillway:** the riser inlet within a sediment retention pond. See Riser.

**Rainfall intensity:** the volume of rainfall falling in a given time. Normally expressed as mm/hour.

**Receiving environment:** the ultimate destination of a discharge, whether via a reticulated stormwater system, from surface runoff or via direct discharge.

**Rehabilitation:** restoration to as near to pre-disturbance conditions as possible. This may entail such measures as revegetation for erosion control, enhancement planting, modification and armouring of watercourses.

**Reno mattress:** a shallow (three to five hundred millimetres deep), wide, flexible woven-wire basket comprised of two to six rectangular cells filled with small stones. Often used at culvert inlets and outlets to dissipate energy and prevent channel erosion.

**Return period:** the statistical interpretation of the frequency of a given intensity and duration of a rainstorm event. Refer AEP.

**Revegetation:** the establishment of vegetation to stabilise a site.

**Riparian protection area:** An area adjacent to a watercourse designated as a non-disturbance zone to provide a buffer between receiving environments (e.g. watercourses) and the area of operation.

**Riser:** in a sediment retention pond, a vertically placed pipe to which decant pipes are attached, which forms the inlet to the primary spillway.

**River:** a continually or intermittently flowing body of fresh water; and includes a stream and modified watercourse; but does not include any artificial watercourse (including an irrigation canal, water supply race, canal for the supply of water for electricity power generation, and farm drainage canal).

**Saturation point:** in soils, the point at which a soil or an aquifer will no longer absorb any amount of water without losing an equal amount.

**Scarified:** shallow subsurface disturbance with a tine implement to provide surface roughening, used before topsoiling and revegetation.

**Scour:** the erosive, tractive or digging action of flowing water; the downward or lateral erosion caused by water. Channel-forming stream scour is caused by the sweeping away of mud and silt from the outside bank of a curved channel (meander), particularly during a flood.

**Sediment:** solid material, both mineral and organic, that is in suspension, is being transported, or has been moved from site of origin by air, water, gravity, or ice and has come to rest on the earth's surface either above or below water.

**Sediment delivery ratio:** the proportion of the soil eroded from within a catchment area that actually reaches sediment treatment controls or water bodies.

**Sediment texture:** the relative proportions of different sizes of sediment and soil particles that can be separated by screening. Refer also to Soil texture.

**Sediment yield:** the quantity of sediment discharged from a particular site or catchment in a given time, measured in dry weight or by volume. When erosion and sediment control measures are in place, sediment yield is the sediment discharged from the site after passing through those measures.

**Sensitive areas:** include water bodies used for public water supply, any river, lake, stream, pond or wetland, sensitive crops or farming systems (e.g. organic farms) and any place, area or feature of special significance to tangata whenua as identified in the Environment Canterbury Natural Resources Regional Plan.

**Settling:** the downward movement of suspended solids through the water column.

**Shear strength:** the ability to resist shear (slip) forces.

**Sheet flow:** shallow dispersed overland flow.

**Shutter boards:** plywood or similar sheeting supported by light timber framing normally used for boxing concrete forms.

**Silt:** a soil consisting of particles between 0.05 and 0.002 millimetres in equivalent diameter; a soil textural class. Refer Figure 3.4.

**Silt loam:** a soil textural class containing a large amount of silt and small quantities of sand and clay. Refer Figure 3.5.

**Silty clay:** a soil textural class containing a relatively large amount of silt and clay and a small amount of sand. Refer Figures 3.4 and 3.5.

**Slope:** degree of deviation of a surface from the horizontal, measured as a numerical ratio, as a percent, or in degrees. Expressed as a ratio, the first number is the horizontal distance (run) and the second number is the vertical distance (rise), as 2:1. A 2:1 slope is a fifty percent slope.

Expressed in degrees, the slope is the angle from the horizontal plane, with a 90° slope being vertical (maximum) and a 45° slope being a 1:1 slope. (Source: USEPA Polluted Runoff (Nonpoint Source Pollution) Management Measures for Forestry - III. Glossary)

<http://www.epa.gov/nps/MMGI/Chapter3/ch3-3.html>, accessed 24 May 2006).

**Small site:** small areas of earth disturbance that normally do not require a consent from Environment Canterbury or the city or district council, such as individual residential building sites. Refer Permitted activities.

**Soil:** the unconsolidated mineral and organic material on the surface of the earth that serves as a natural medium for the growth of land plants. Earth and rock particles resulting from the physical and chemical disintegration of rocks, which may or may not contain organic matter. Includes fine material (silts and clays), sand and gravel.

**Soil structure:** soil structure reflects the pore space within a soil available for aeration and storage of water. It is a measure of bulk density, and as a rule the higher the soil bulk density the poorer the structure. The combination or arrangement of primary soil particles into secondary particles, units or peds. Good soil structure is important for plant growth.

**Soil texture:** the relative proportions of various particle sizes in a soil material. Refer Sediment texture and Figures 3.4 and 3.5.

**Spreader (hydraulics):** a device for distributing water uniformly in or from a channel.

**Stabilisation:** providing adequate measures, vegetative and/or structural that will protect exposed soil to prevent erosion.

**Stabilised area:** an area sufficiently covered by erosion-resistant material such as a good cover of grass, or paving by asphalt, concrete or aggregate, in order to prevent erosion of the underlying soil.

**Staging of construction:** the completion of bulk earthworks in successive time phases to minimise the area of bare earth exposed at any one time.

**Subsoil:** the B-horizons of soils with distinct profiles. In soils with weak profile development, the subsoil can be defined as the soil below the ploughed soil (or its equivalent of surface soil), in which roots normally grow.

**Sump:** Small chamber incorporating a sediment trap that runoff flows through before entering a reticulated stormwater system (also termed a catchpit).

**Surface runoff:** rain that runs off rather than being infiltrated into or retained on the surface on which it falls.

**Surface water:** all water with its surface exposed to the atmosphere.

**Suspended solids:** solids either floating or suspended in water.

**Swale:** a constructed, elongated depression in the land surface that can be seasonally wet, is usually heavily vegetated, and is normally without flowing water. Swales conduct stormwater into primary drainage channels and can provide some pollutant retention and groundwater recharge.

**Tackifier:** A compound that is added to straw mulch to bind it together and prevent it being blown around by the wind. See Guar.

**Temporary watercourse crossing:** a stable watercourse crossing that is installed for the duration of an operation and is removed in its entirety at the completion of the operation.

**Tensile strength:** resistance to elongation and tearing.

**Time of concentration:** the time for runoff to flow from the most remote part of the drainage area to the outlet.

**Toe (of slope):** where the slope stops or levels out. Bottom of the slope.

**Topsoil:** fertile or desirable soil material (suitable organic and structural properties) used to top-dress roadbanks, subsoils, parent material, etc., to provide a suitable medium for plant growth.

**Unified soil classification system (engineering):** a classification system based on the identification of soils according to their particle size, gradation, plasticity index and liquid limit.

**Uniform flow:** a state of steady flow occurring when the mean velocity and cross-sectional area are equal at all sections of a reach.

**Universal soil loss equation:** an equation used for the design of a water erosion control system:

$A = RKLSCP$  where:

A = the soil loss in tonnes per ha per annum;

R = the rainfall factor;

K = the soil erodibility factor;

LS = the slope length and gradient factor

C = the vegetation factor;

P = the surface roughness factor.

**Water body:** any type of surface water such as watercourses, lakes and wetlands.

**Watercourse:** any pathway for concentrated overland flow, including rivers, streams and ephemeral channels.

**Watershed:** refer Catchment.

**Water table:** the upper surface of the free groundwater in a zone of saturation; locus of points in soil water at which hydraulic pressure is equal to atmospheric pressure.

**Water table drain:** a drain that parallels a carriageway to drain surface and subsurface water from the road formation.

**Wetland:** includes permanently or intermittently wet areas, shallow water, and land water margins that support a natural ecosystem of plants and animals that are adapted to wet conditions. Note: Environment Canterbury is in the process of compiling an inventory of wetlands in the region. When that inventory has been completed, the term wetland in this plan will refer to wetlands listed in that inventory. In the interim, the term wetland has the same meaning as in section 2 of the Resource Management Act 1991.



This Glossary is an adaptation of the one in the Environment Canterbury Erosion and Sediment Control Guideline, 2007 as referenced in the following:

Environment Canterbury, 2007. Erosion and sediment control guidelines for the Canterbury region. Report No. R06/23, Canterbury Regional Council, Christchurch, New Zealand. ISBN No. 1-86937-607-2.

# Appendix B – Soils of New Zealand

## North Island Soil Map as provided by Landcare Research

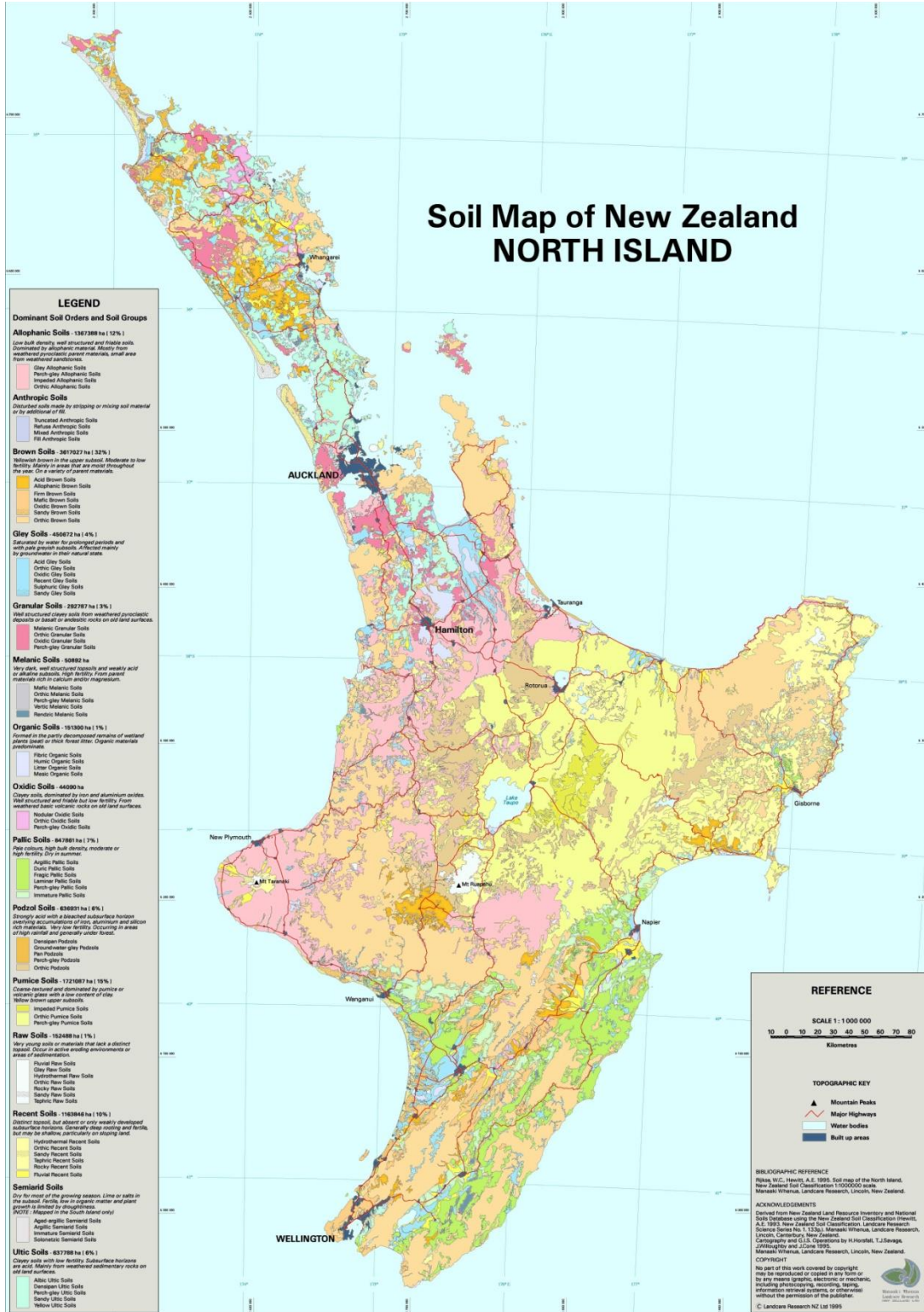

# South Island Soil Map as provided by Landcare Research

