

300 mm  
200  
100  
50  
0 10 mm

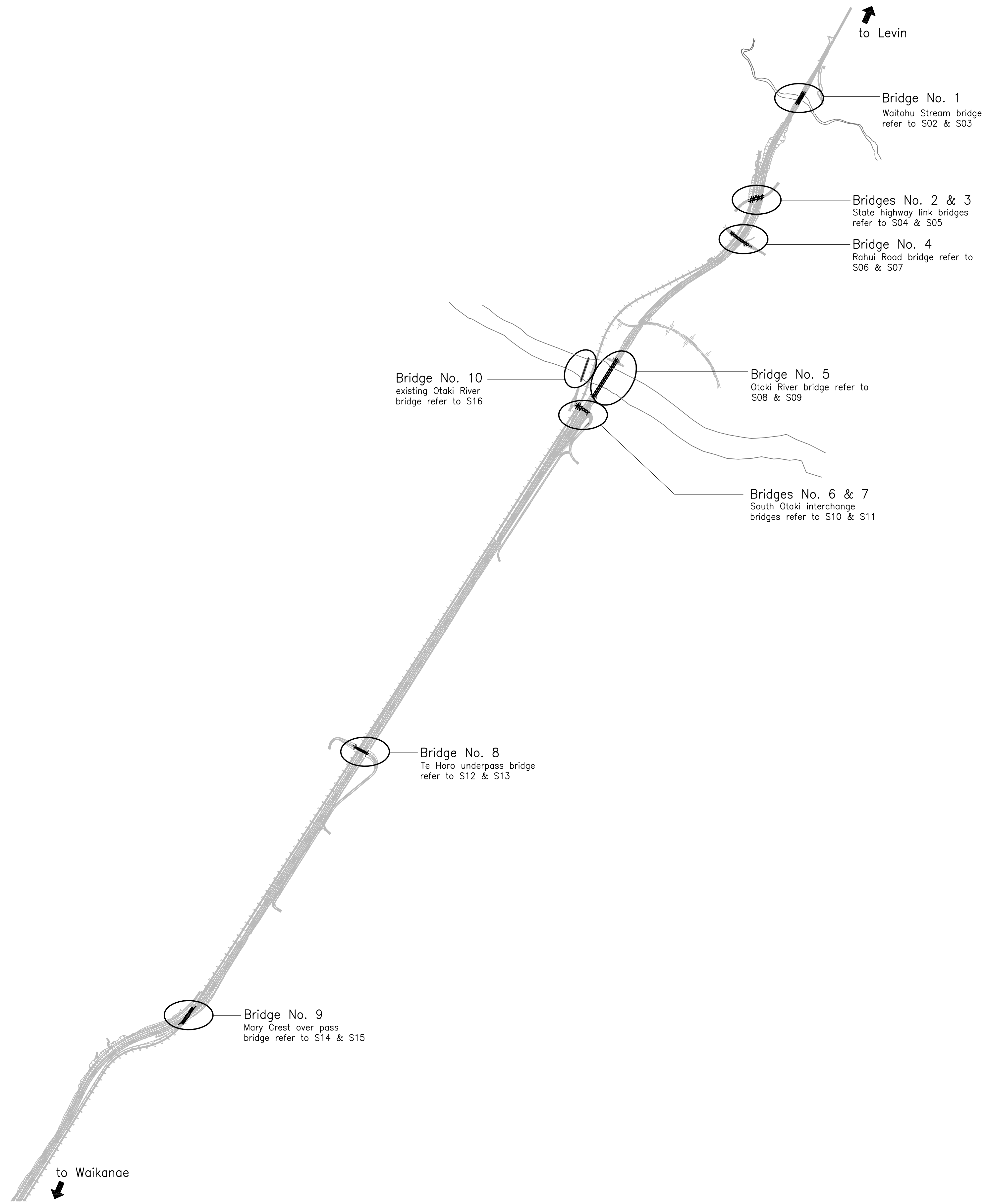

Revision	Amendment	Approved	Revision Date



Project			
NEW ZEALAND TRANSPORT AGENCY PEKA PEKA TO NORTH OTAKI EXPRESSWAY SCHEME ASSESSMENT			
Sheet			
Structures Plans Bridges Location plan			
Drawn	Designed	Approved	Revision Date
JDR	PG	PG	15/03/12
Project No.	Scale	Drawing No.	Sheet No. Revision
5C1814.00	1:20000(A1)	104866-S01	S01 R0

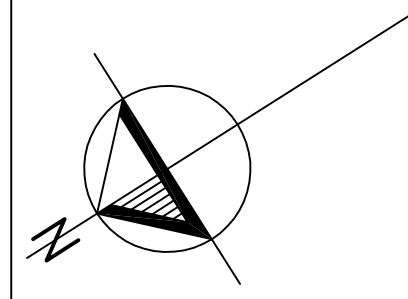

300 mm  
200  
100  
50  
0 10 mm

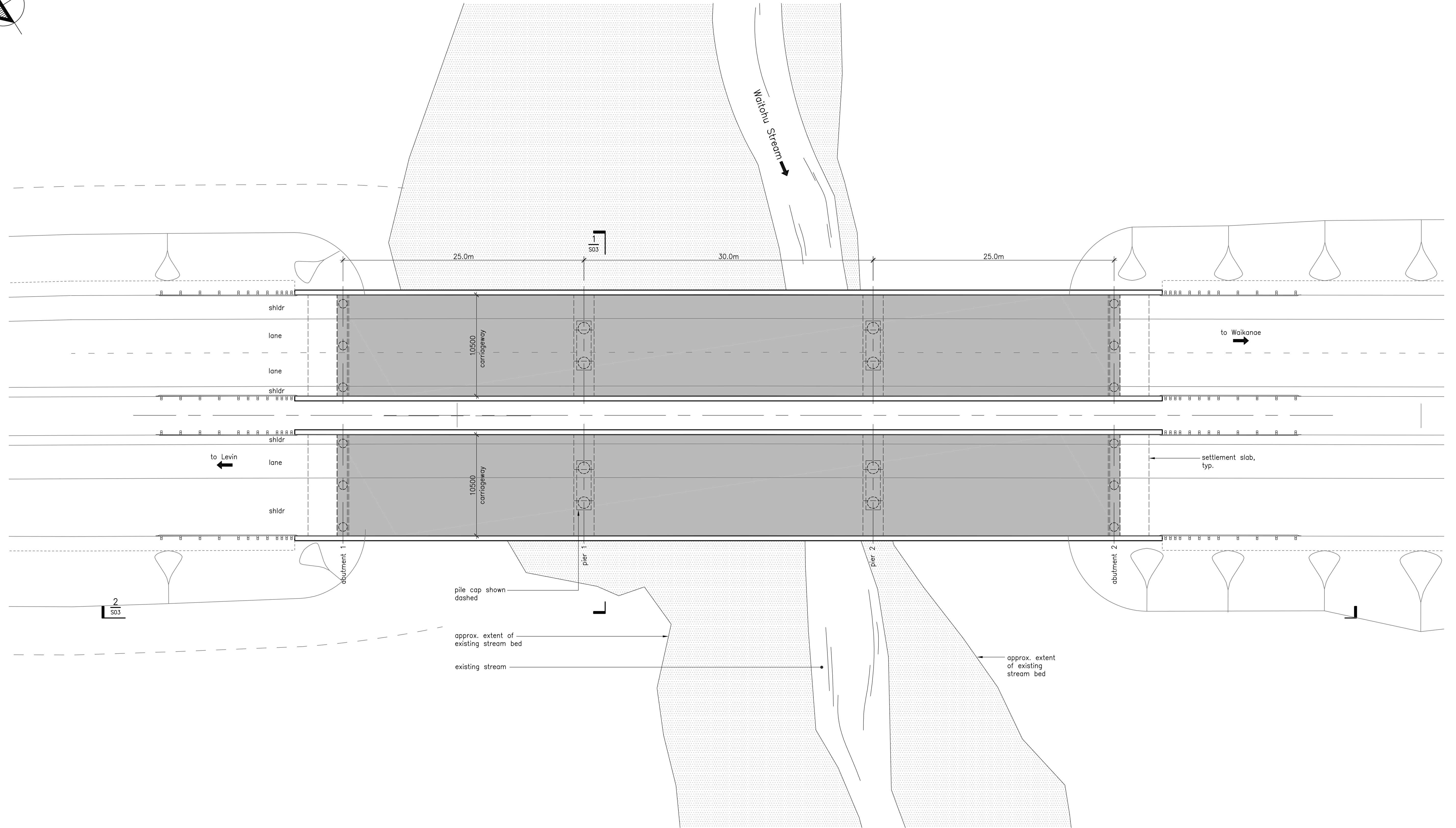

bridge general arrangement plan

Revision	Amendment	Approved	Revision Date



Project  
NEW ZEALAND TRANSPORT AGENCY  
PEKA PEKA TO NORTH OTAKI EXPRESSWAY  
SCHEME ASSESSMENT

Sheet  
Structures Plans  
Bridge No. 1 Waitohu Stream plan

Drawn	Designed	Approved	Revision Date
JDR	PG	PG	15/03/12

Project No.	Scale
5C1814.00	1:200(A1)

Drawing No.	Sheet No.	Revision
104866-S02	S02	R0

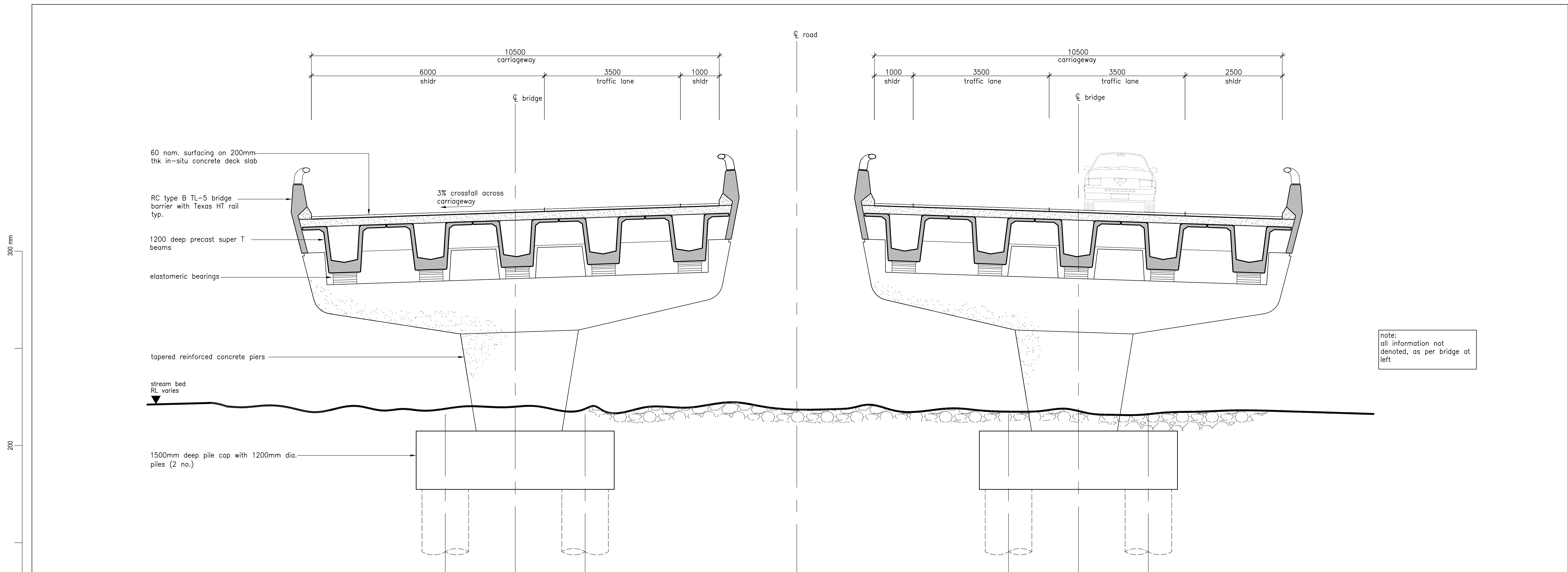

1  
S02  
bridge cross section at pier  
1:50

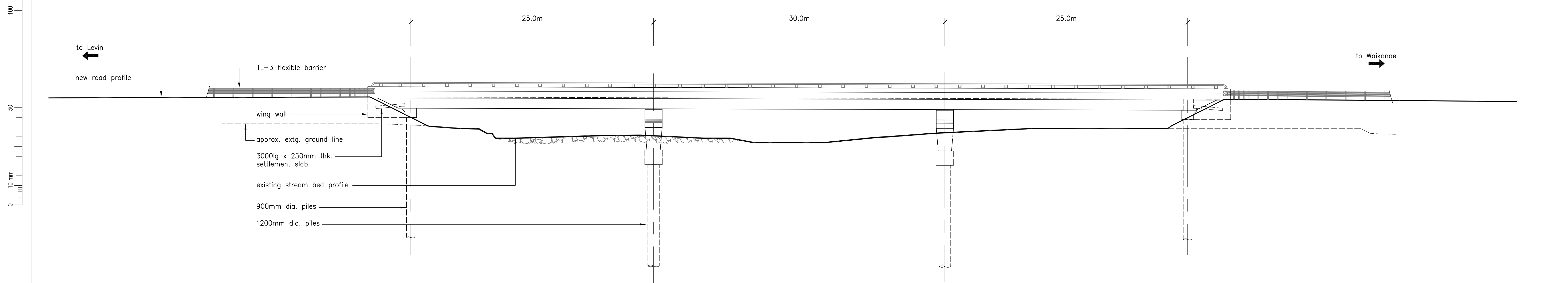



2  
S02  
bridge elevation  
1:200

Revision	Amendment	Approved	Revision Date



NZ TRANSPORT AGENCY  
WAKA KOTAHĪ





Project  
NEW ZEALAND TRANSPORT AGENCY  
PEKA PEKA TO NORTH OTAKI EXPRESSWAY  
SCHEME ASSESSMENT

Sheet  
Structures Plans  
Bridge No. 1 Waitohu Stream section & elevation

Drawn JDR	Designed PG	Approved PG	Revision Date 15/03/12
Project No. 5C1814.00	Scale As shown(A1)	Drawing No. 104866-S03	Sheet No. S03
			Revision R0

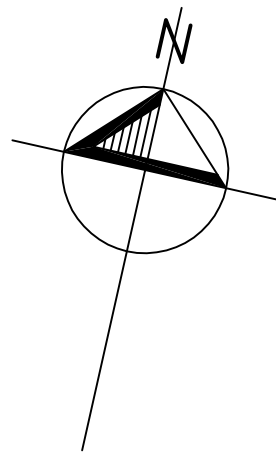



300 mm  
200  
100  
50  
0 10 mm

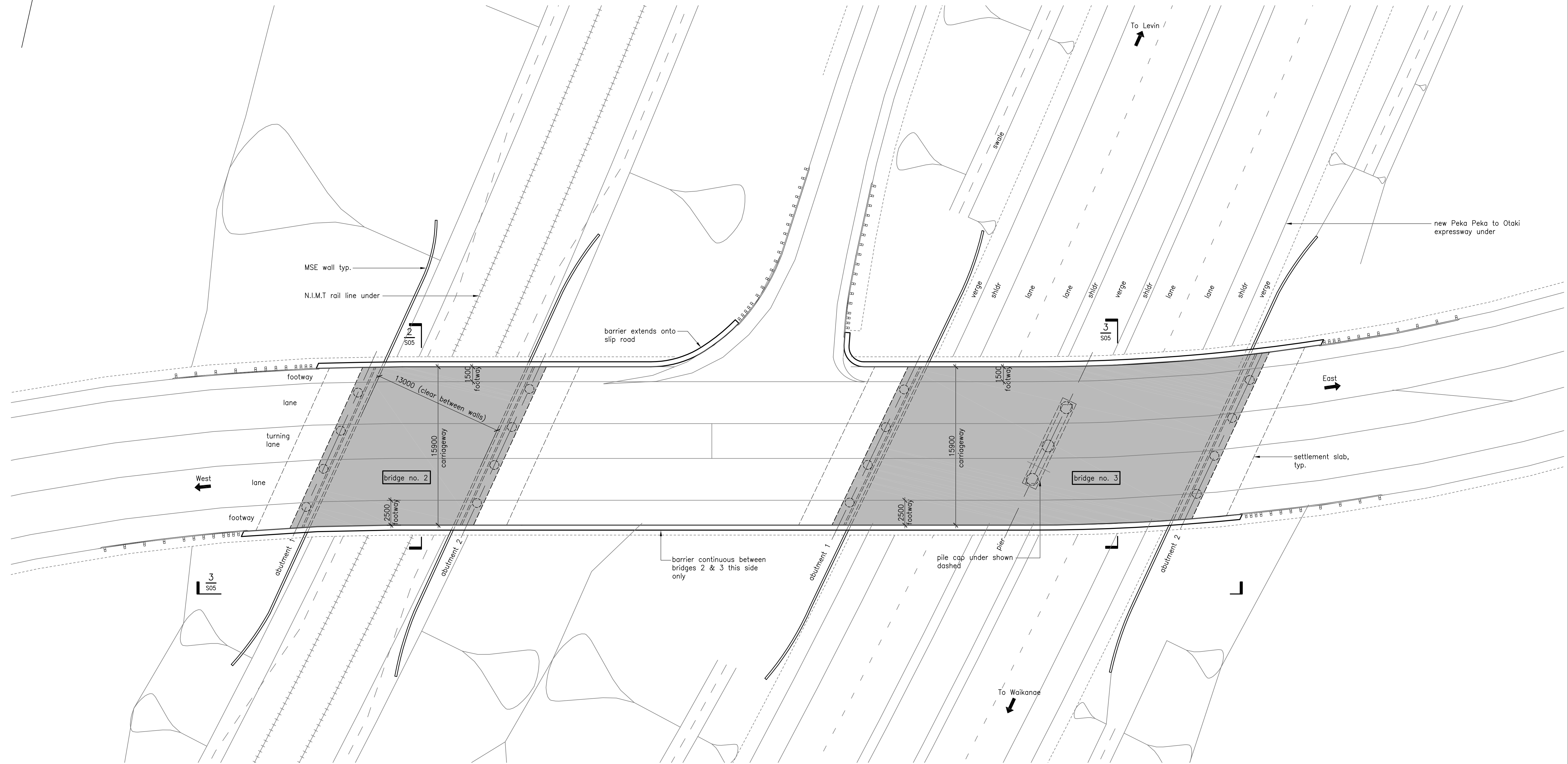

bridges general arrangement plan

Revision	Amendment	Approved	Revision Date



Drawn	Designed	Approved	Revision Date
JDR	PG	PG	15/03/12

Project No.	Scale
5C1814.00	1:200(A1)

Project	
NEW ZEALAND TRANSPORT AGENCY PEKA PEKA TO NORTH OTAKI EXPRESSWAY SCHEME ASSESSMENT	
Sheet	
Structures Plans Bridges No. 2 & 3 North Otaki plan	
Drawing No.	Sheet No.
104866-S04	S04
Revision	R0

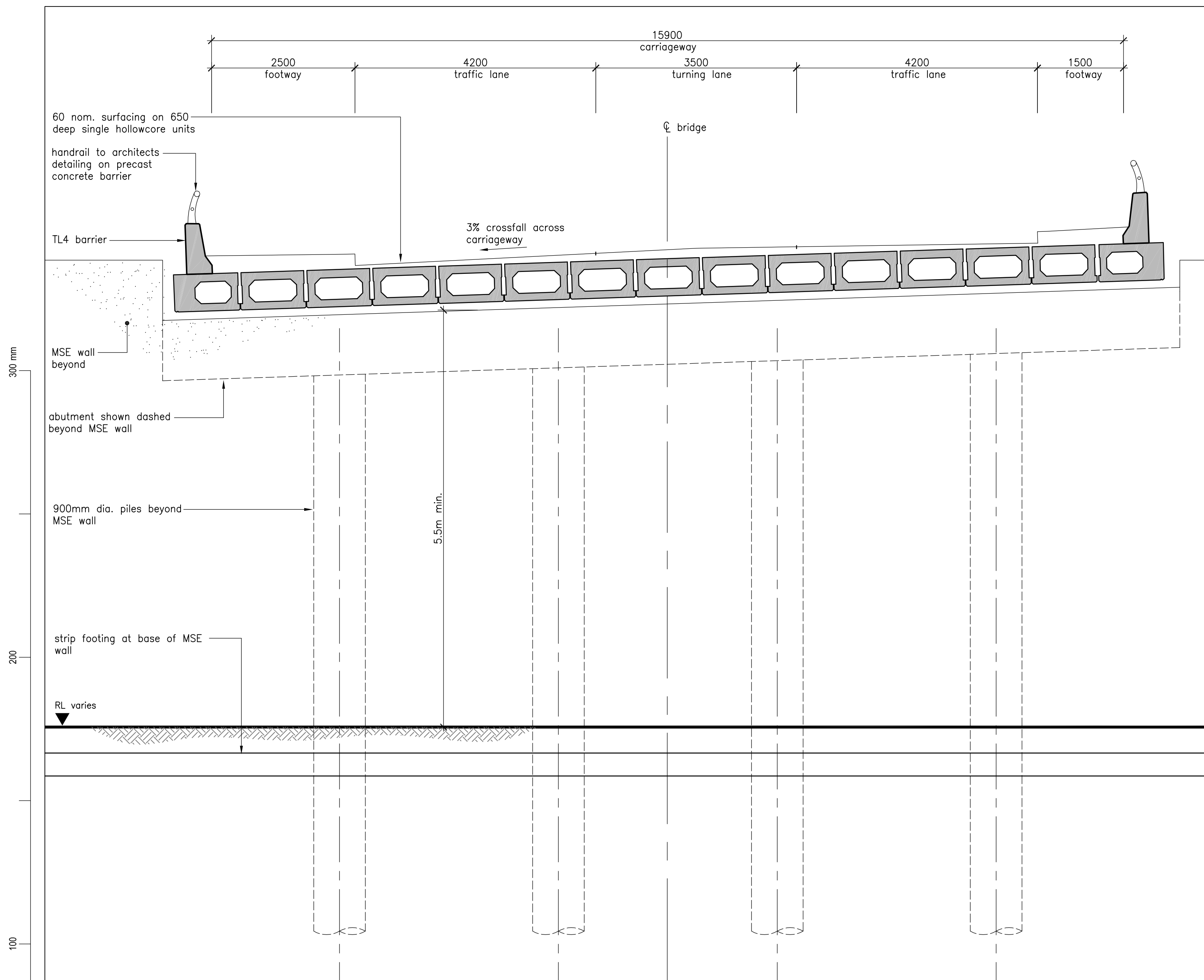

2  
S04  
bridge 2 cross section  
1:50

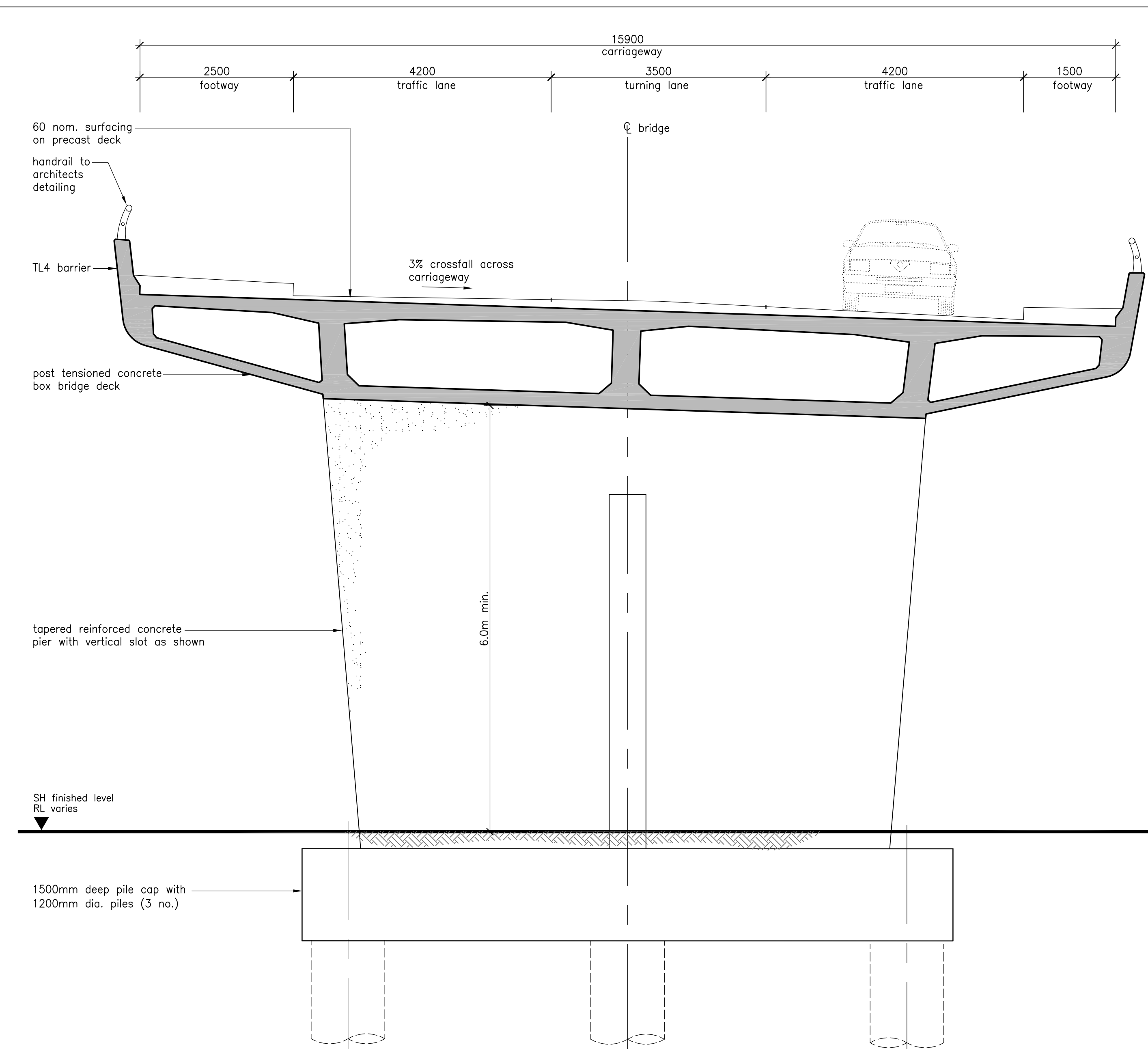

1  
S04  
bridge 3 cross section at pier  
1:50

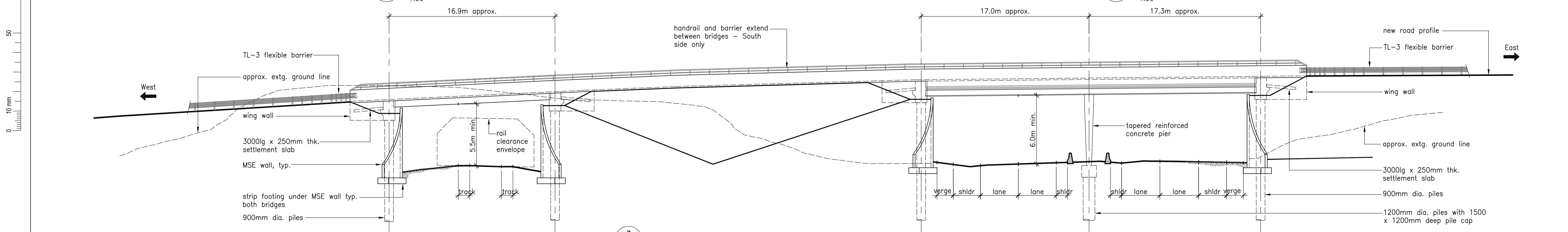

3  
S04  
bridges 2 & 3 elevation  
1:200

note:  
protection barriers and screens over  
rail corridor not shown but shall be  
provided. Details pending discussions  
with Kiwi Rail

Revision	Amendment	Approved	Revision Date



Drawn	Designed	Approved	Revision Date
JDR	PG	PG	15/03/12
Project No.	Scale	Drawing No.	Sheet No.
5C1814.00	As shown(A1)	104866-S05	S05

Project  
NEW ZEALAND TRANSPORT AGENCY  
PEKA PEKA TO NORTH OTAKI EXPRESSWAY  
SCHEME ASSESSMENT

Sheet  
Structures Plans  
Bridges No. 2 & 3 North Otaki sections & elevation

Revision  
R0



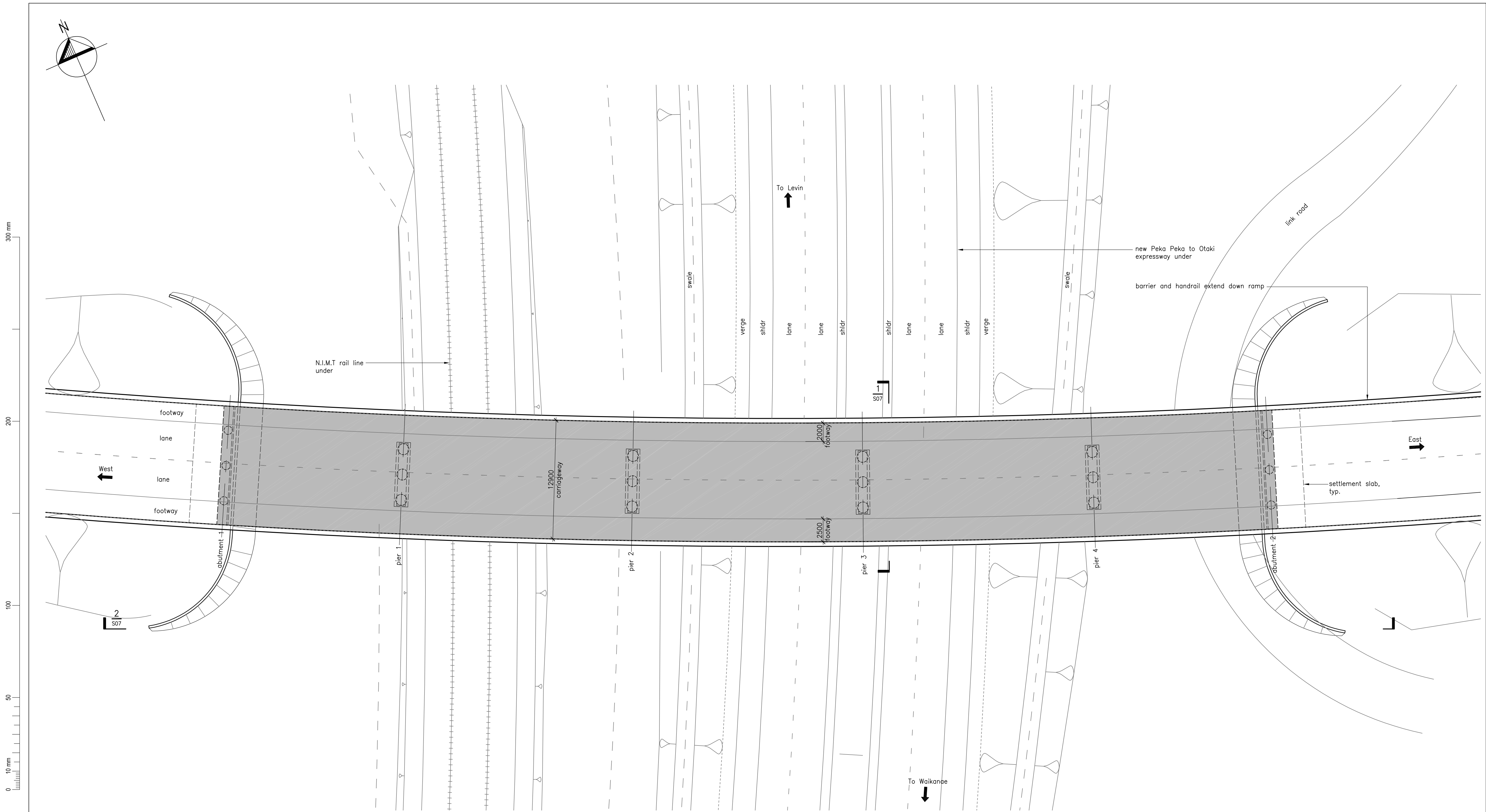

bridge general arrangement plan

Revision	Amendment	Approved	Revision Date



Drawn	Designed	Approved	Revision Date
JDR	PG	PG	15/03/12
Project No. 5C1814.00		Scale 1:200(A1)	

Project	
NEW ZEALAND TRANSPORT AGENCY PEKA PEKA TO NORTH OTAKI EXPRESSWAY SCHEME ASSESSMENT	
Sheet	
Structures Plans Bridge No. 4 Rahui Road plan	
Drawing No. 104866-S06	Sheet No. S06 Revision R0

300 mm  
200  
100  
50  
10 mm  
0

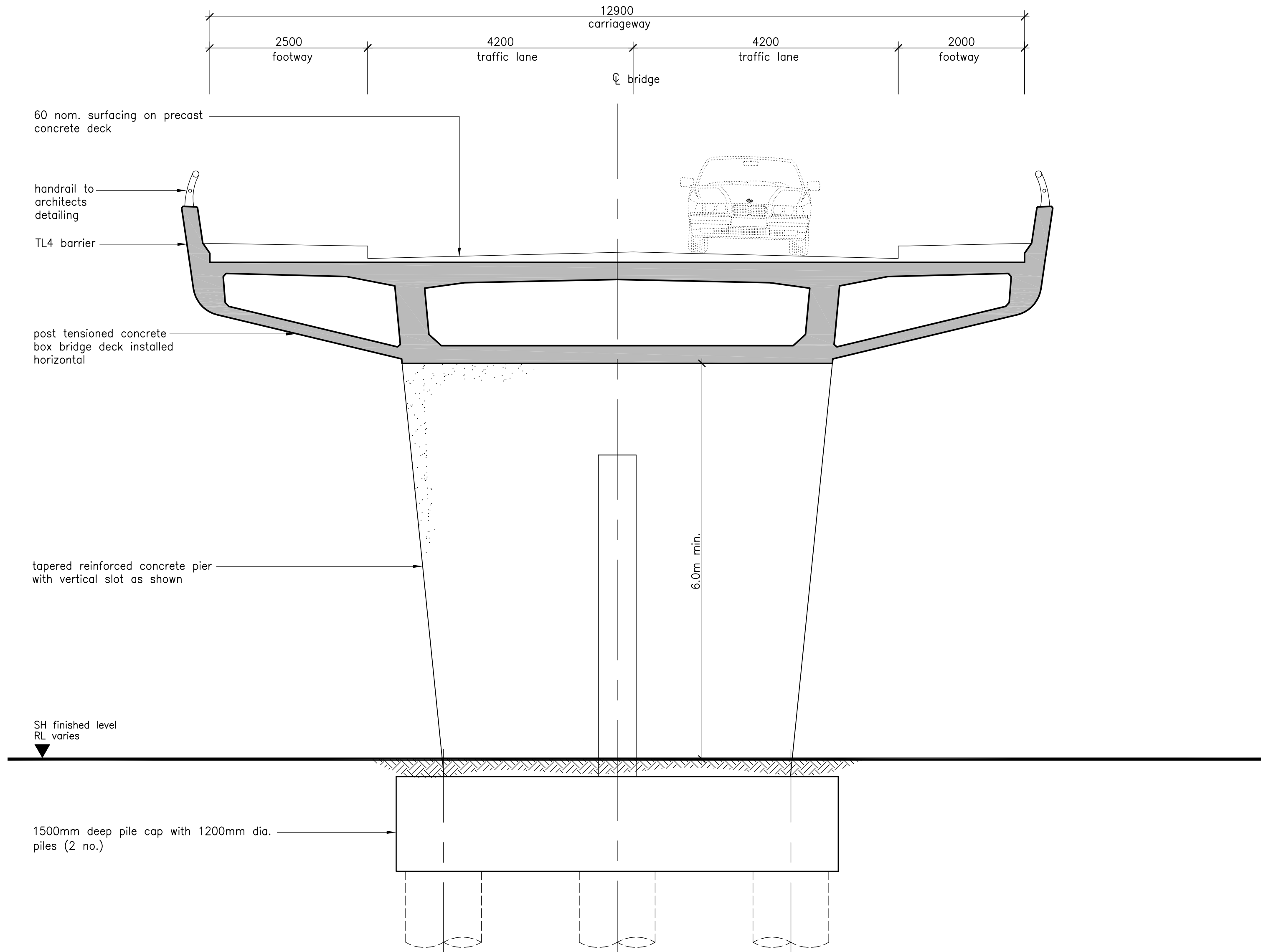

1  
S06  
1:50 bridge cross section at pier

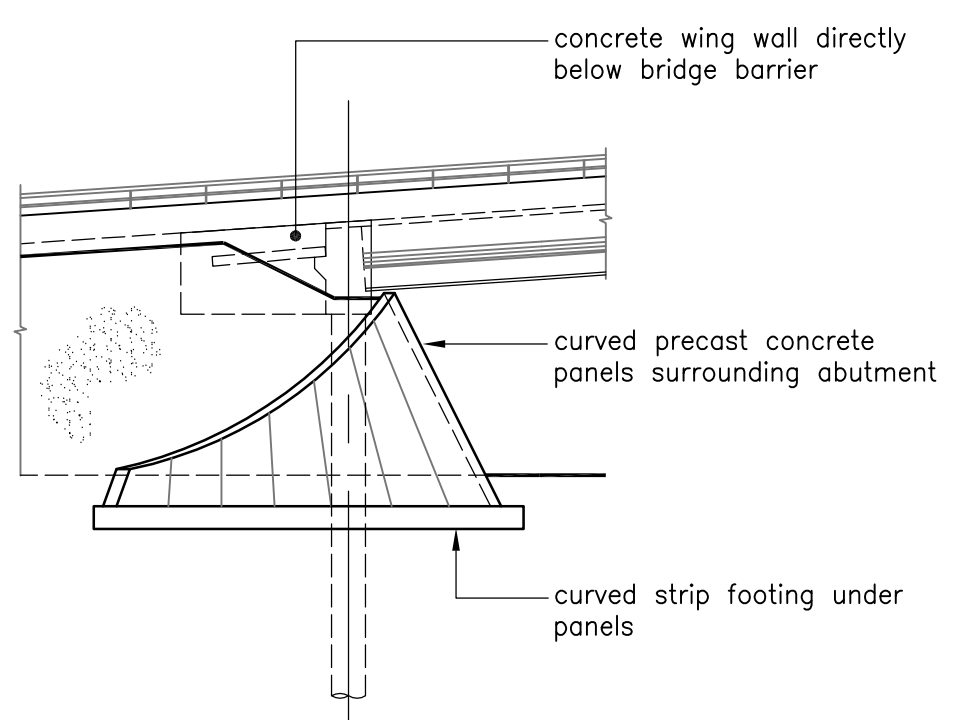

3  
1:200 bridge part elevation showing precast abutment surround

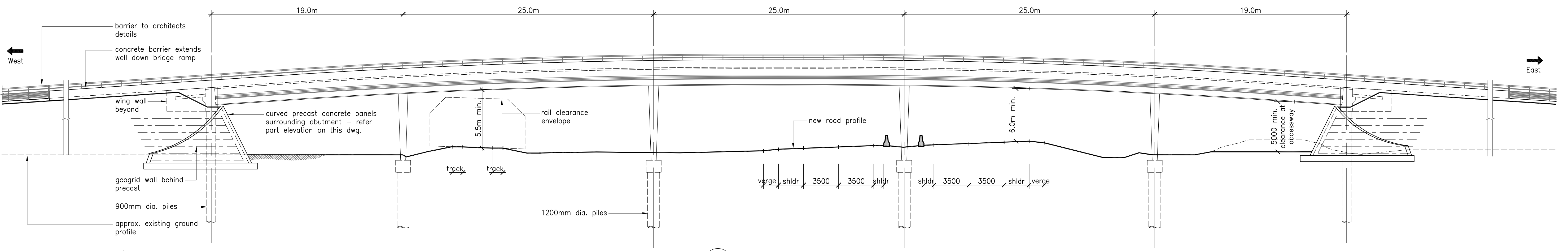

2  
S06  
1:200 bridge elevation

note:  
protection barriers and screens over rail corridor not shown but shall be provided. Details pending discussions with Kiwi Rail

Revision	Amendment	Approved	Revision Date



Drawn	Designed	Approved	Revision Date
JDR	PG	PG	15/03/12
Project No. 5C1814.00		Scale As shown(A1)	Revision Date

Project	
NEW ZEALAND TRANSPORT AGENCY PEKA PEKA TO NORTH OTAKI EXPRESSWAY SCHEME ASSESSMENT	
Sheet	
Structures Plans Bridge No. 4 Rahui Road section & elevation	
Drawing No. 104866-S07	Revision R0



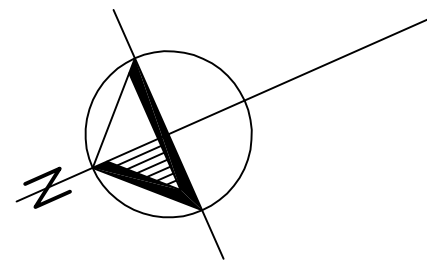

300 mm  
200  
100  
50  
0 10 mm

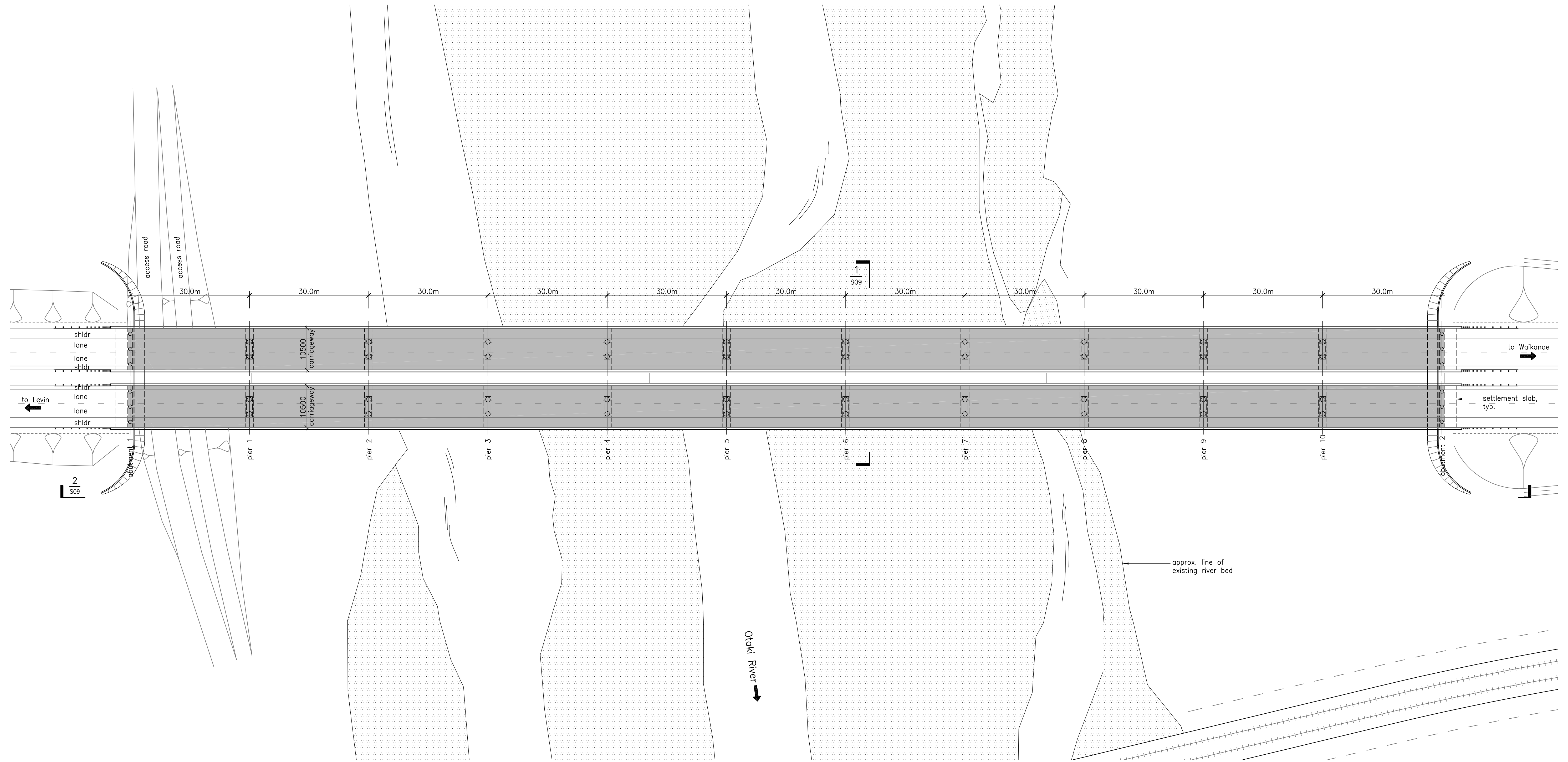

bridge general arrangement plan

Revision	Amendment	Approved	Revision Date



Drawn	Designed	Approved	Revision Date
JDR	PG	PG	15/03/12

Project No.	Scale
5C1814.00	1:500(A1)

Project  
NEW ZEALAND TRANSPORT AGENCY  
PEKA PEKA TO NORTH OTAKI EXPRESSWAY  
SCHEME ASSESSMENT

Sheet  
Structures Plans  
Bridge No. 5 Otaki River plan

Drawing No.	Sheet No.	Revision
104866-S08	S08	R0



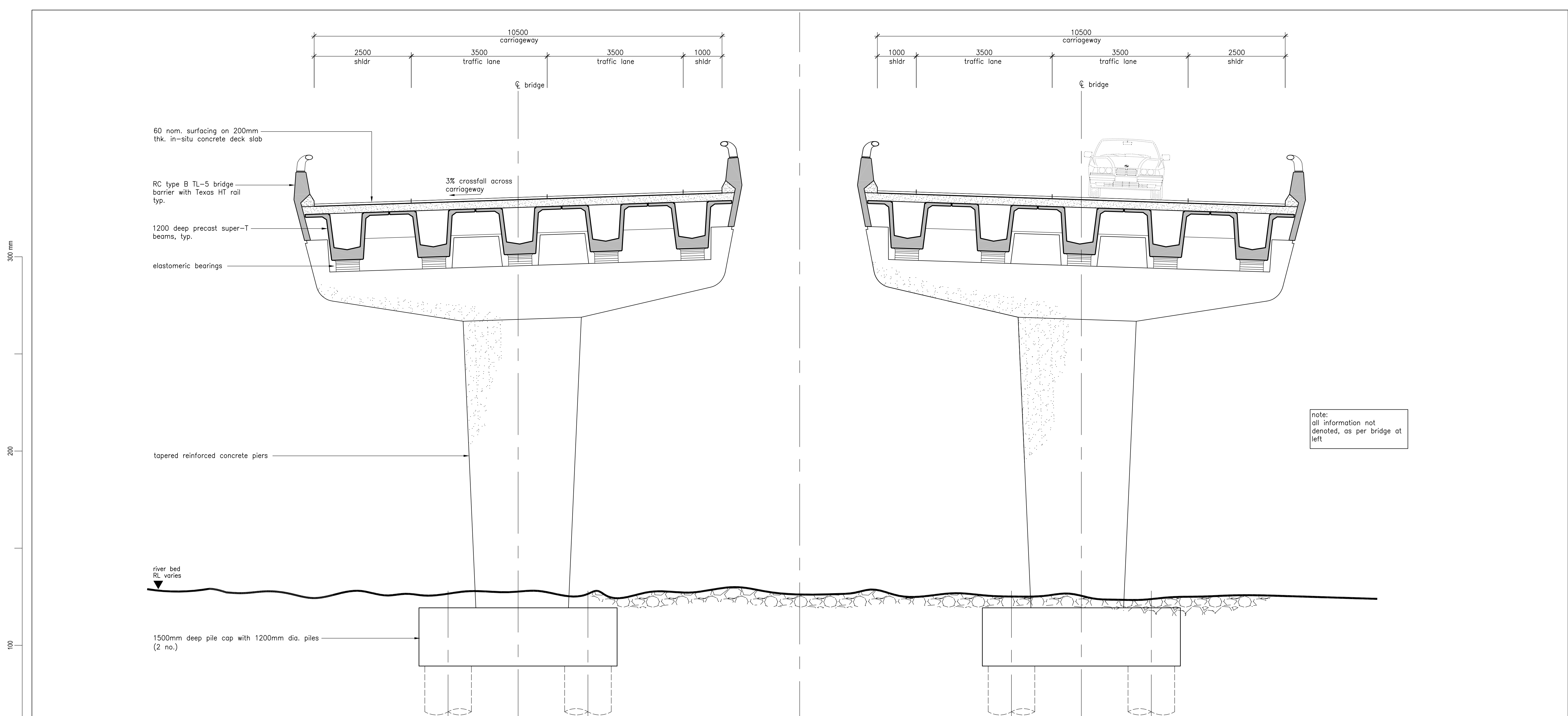

1  
S08  
bridge cross section at pier  
1:50

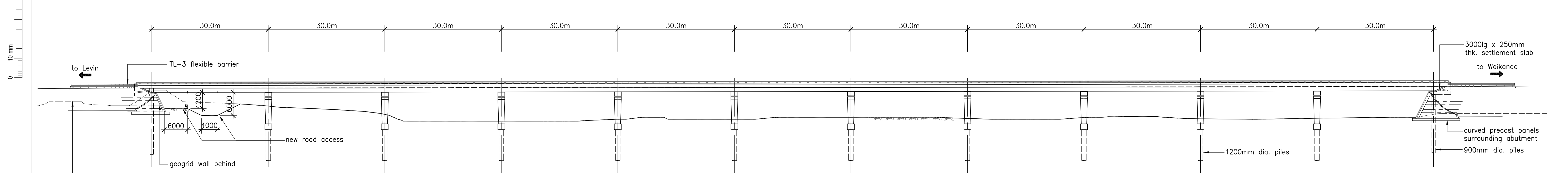

2  
S08  
bridge elevation  
1:500

Revision	Amendment	Approved	Revision Date



Drawn	Designed	Approved	Revision Date
JDR	PG	PG	15/03/12

Project No.	Scale
5C1814.00	As shown(A1)

Project	
NEW ZEALAND TRANSPORT AGENCY PEKA PEKA TO NORTH OTAKI EXPRESSWAY SCHEME ASSESSMENT	
Sheet	
Structures Plans Bridge No. 5 Otaki River section & elevation	
Project No.	Sheet No.
5C1814.00	S09
Drawing No.	Revision
104866-S09	R0

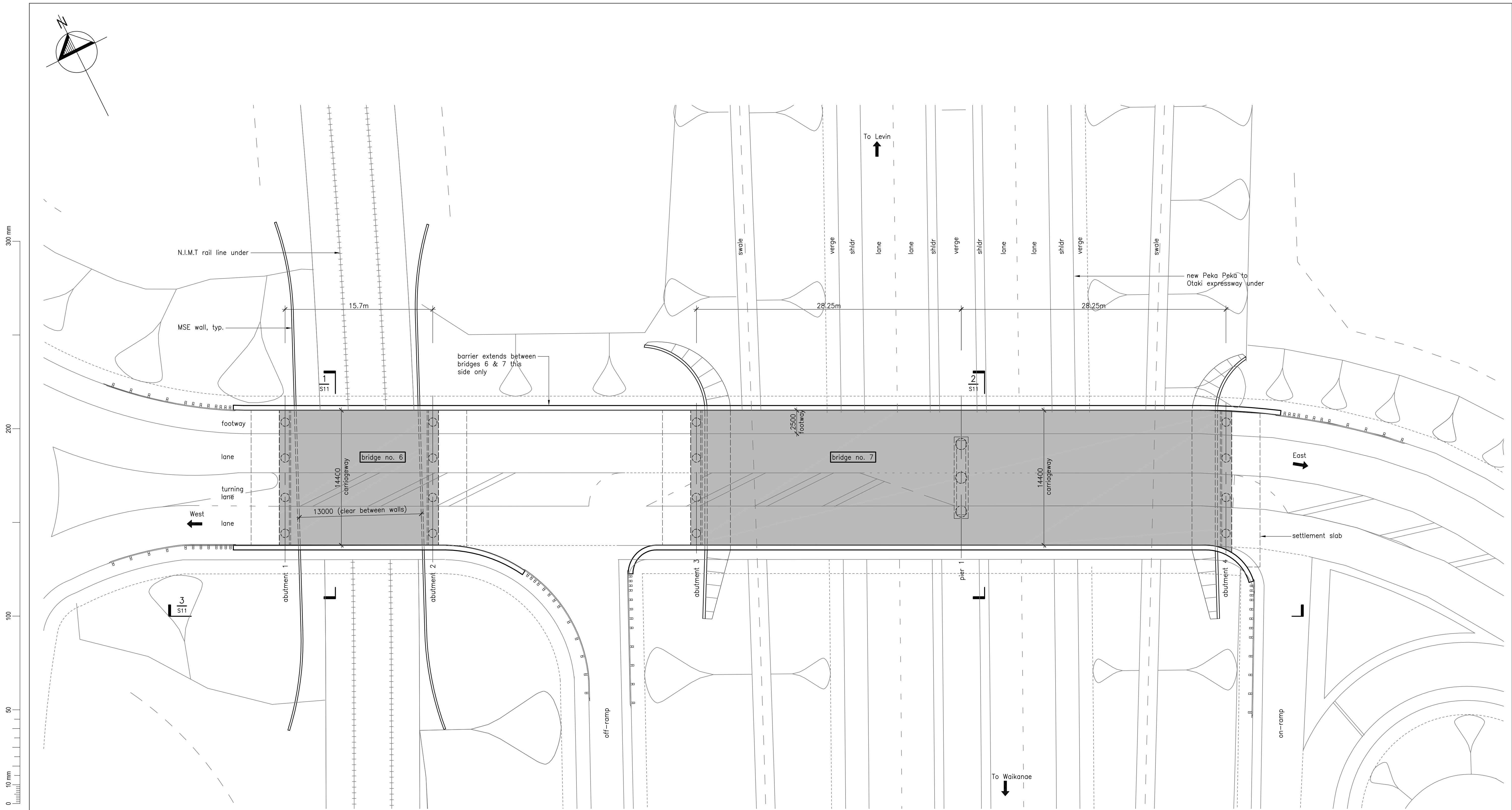

bridges general arrangement plan

Revision	Amendment	Approved	Revision Date



Drawn	Designed	Approved	Revision Date
JDR	PG	PG	15/03/12
Project No. 5C1814.00		Scale 1:200(A1)	

Project	
NEW ZEALAND TRANSPORT AGENCY PEKA PEKA TO NORTH OTAKI EXPRESSWAY SCHEME ASSESSMENT	
Sheet	
Structures Plans Bridges No. 6 & 7 South Otaki plan	
Drawing No. 104866-S10	Sheet No. R0



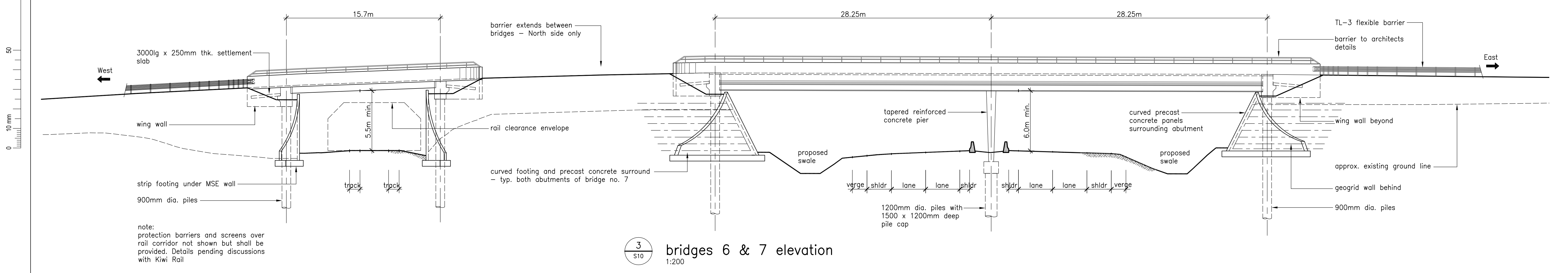
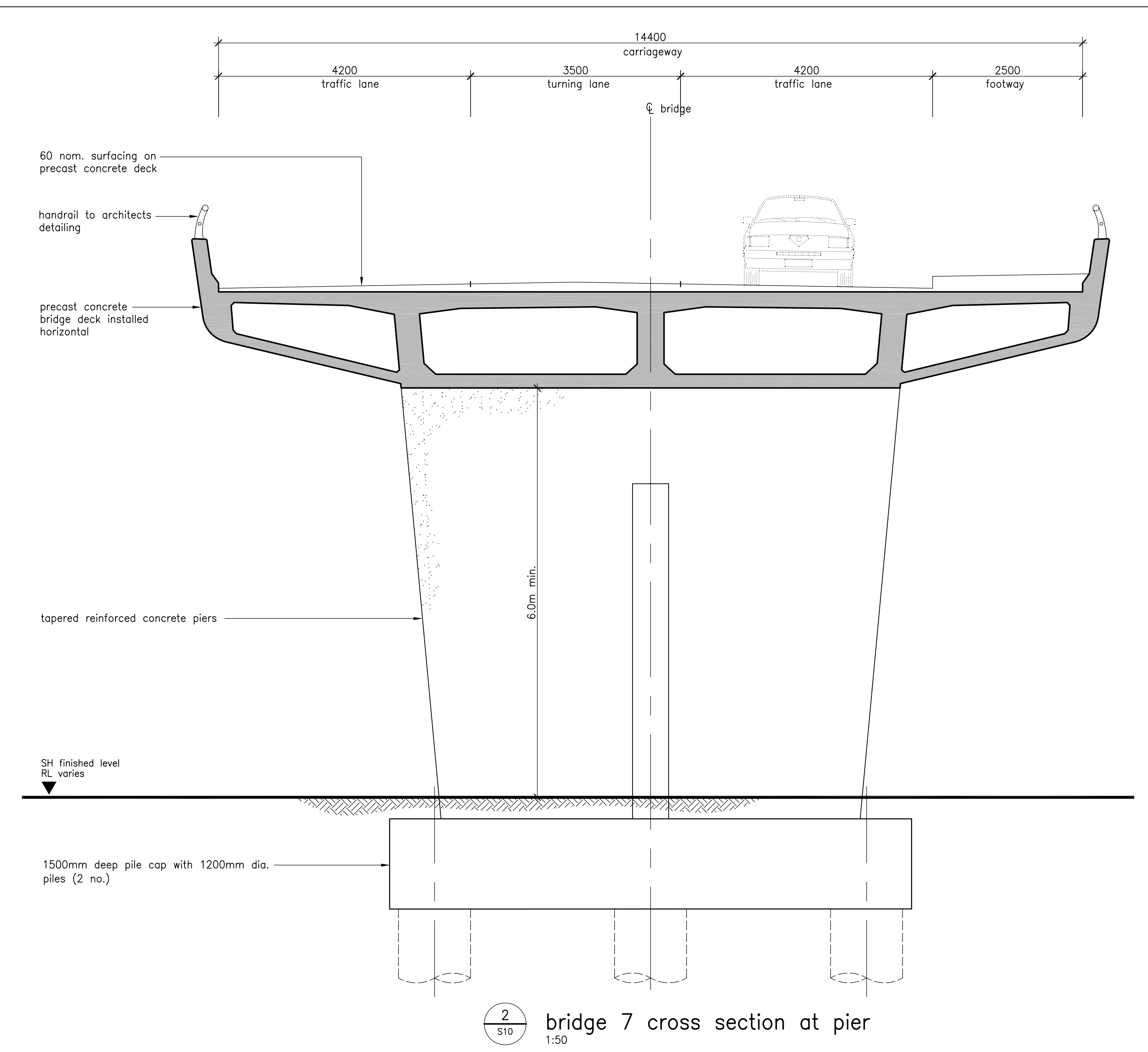
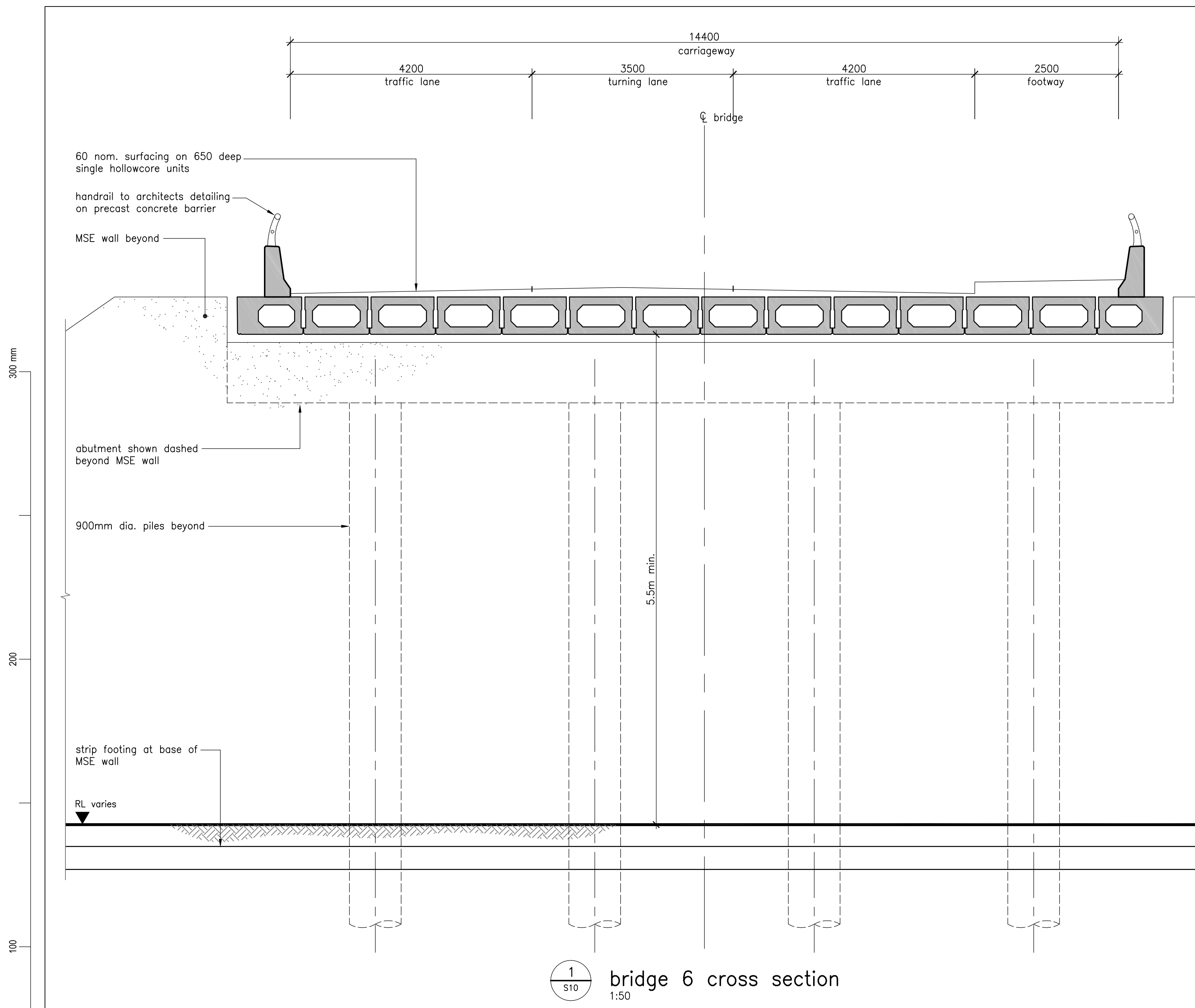

Revision	Amendment	Approved	Revision Date

NZ TRANSPORT AGENCY  
WAKA KOTAHI

OPUS URS

Hobson Consulting Group

Project			
NEW ZEALAND TRANSPORT AGENCY PEKA PEKA TO NORTH OTAKI EXPRESSWAY SCHEME ASSESSMENT			
Sheet			
Structures Plans Bridges No. 6 & 7 South Otaki sections & elevation			
Drawn	Designed	Approved	Revision Date
JDR	PG	PG	15/03/12
Project No.	Scale	Drawing No.	Sheet No. / Revision
5C1814.00	As shown(A1)	104866-S11	S11 / R0

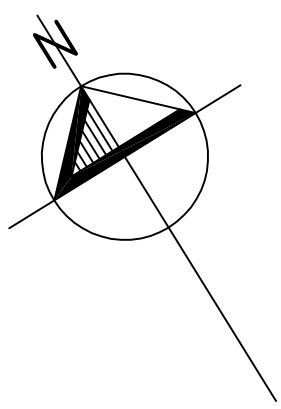

300 mm  
200  
100  
50  
0 10 mm

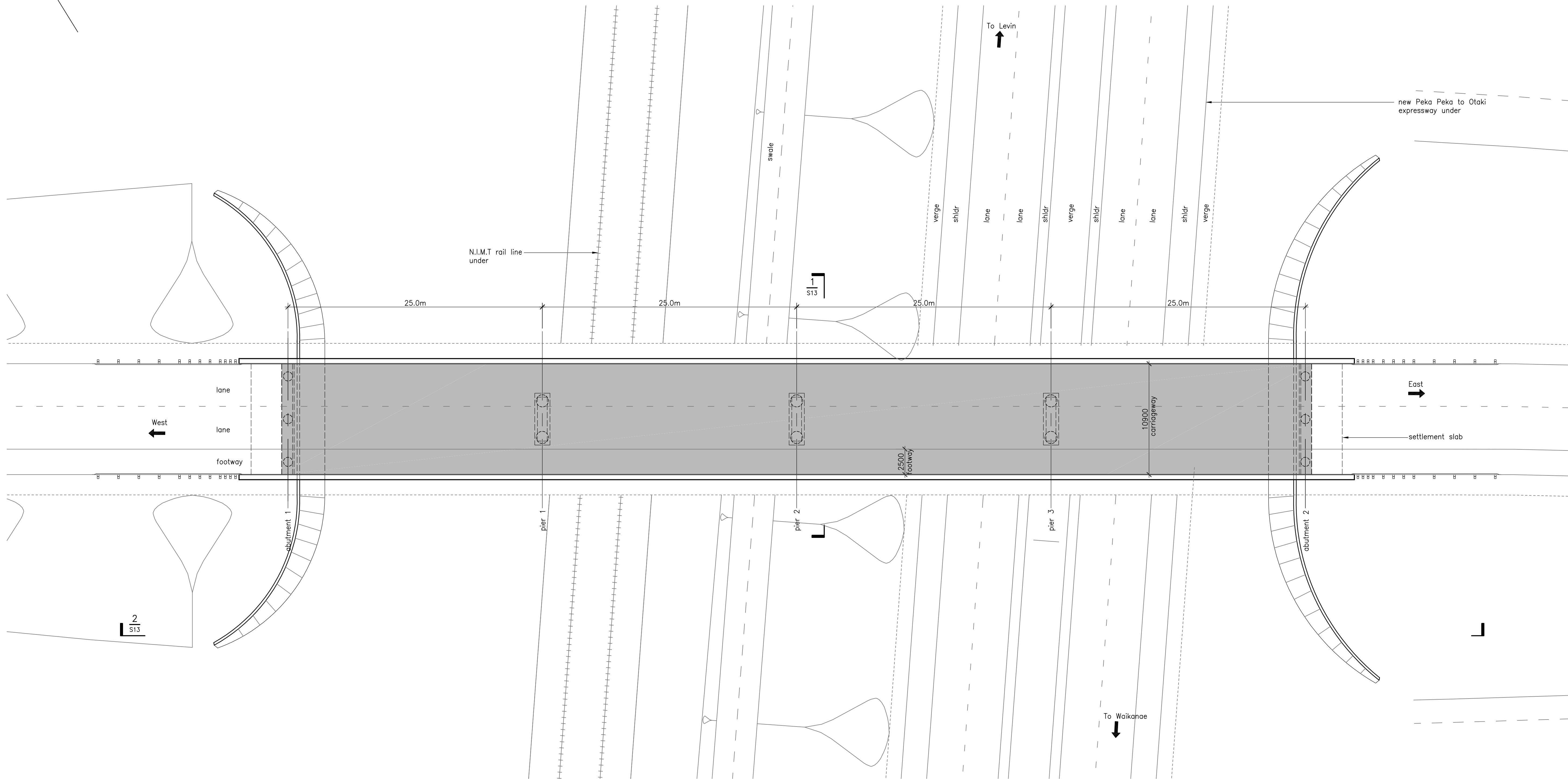

bridge general arrangement plan

Revision	Amendment	Approved	Revision Date



Drawn	Designed	Approved	Revision Date
JDR	PG	PG	15/03/12
Project No. 5C1814.00		Scale 1:200(A1)	

Project	
NEW ZEALAND TRANSPORT AGENCY PEKA PEKA TO NORTH OTAKI EXPRESSWAY SCHEME ASSESSMENT	
Sheet	
Structures Plans Bridge No. 8 Te Horo plan	
Drawing No. 104866-S12	Revision R0



300 mm  
200  
100  
50  
10 mm  
0

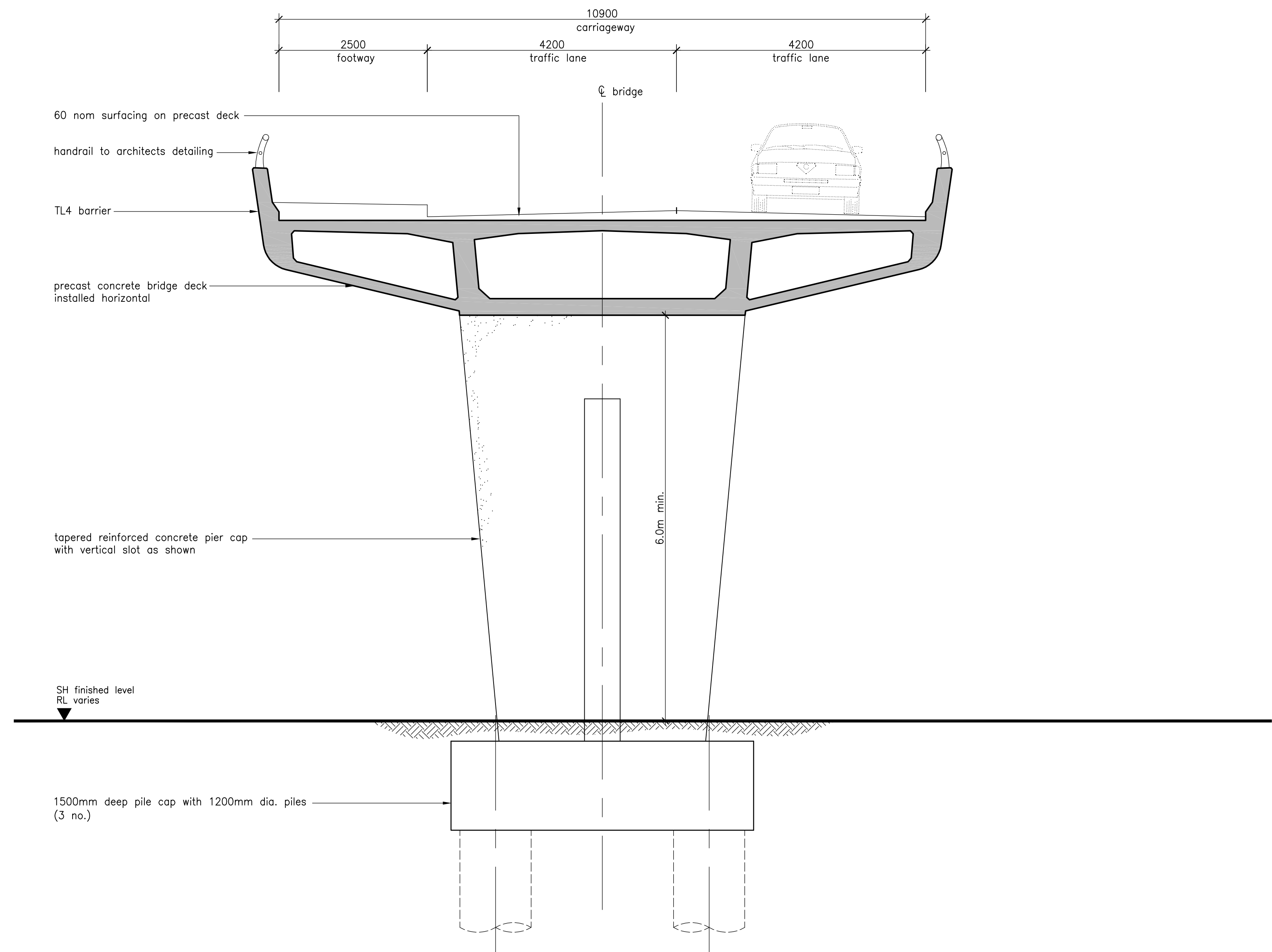

1  
S12  
1:50  
bridge cross section at pier

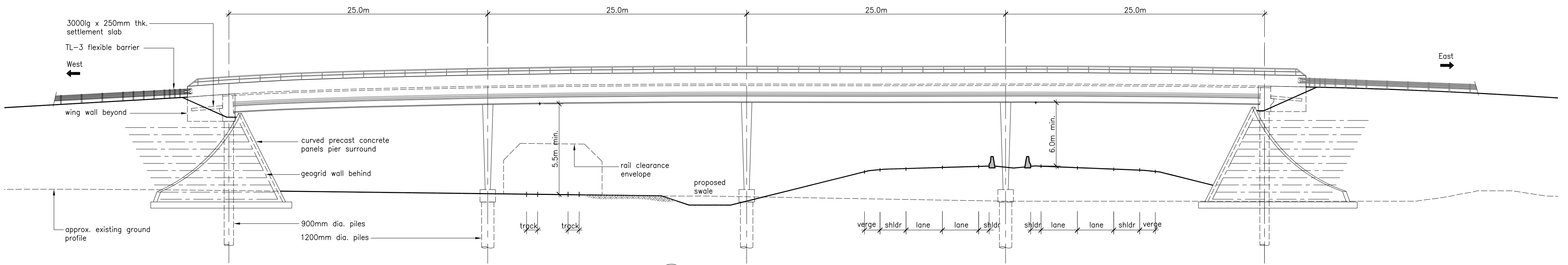

2  
S12  
1:200  
bridge elevation

note:  
protection barriers and screens over rail corridor not shown but shall be provided. Details pending discussions with Kiwi Rail

Revision	Amendment	Approved	Revision Date



Drawn	Designed	Approved	Revision Date
JDR	PG	PG	15/03/12
Project No.	Scale	Drawing No.	
5C1814.00	as shown(A1)	104866-S13	Sheet No. Revision
			S13 R0

Project  
NEW ZEALAND TRANSPORT AGENCY  
PEKA PEKA TO NORTH OTAKI EXPRESSWAY  
SCHEME ASSESSMENT

Sheet  
Structures Plans  
Bridge No. 8 Te Horo section & elevation

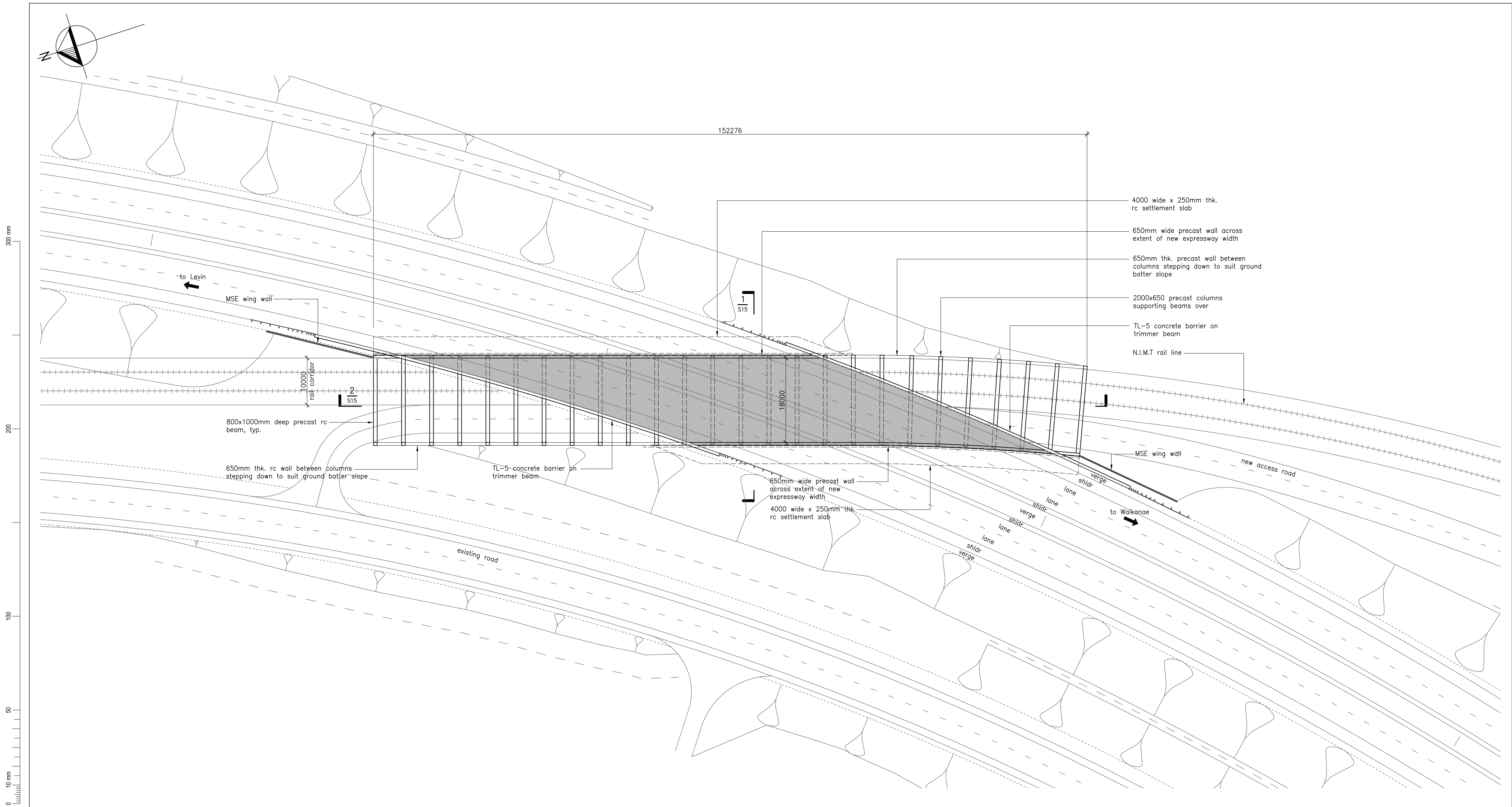

bridge general arrangement plan

Revision	Amendment	Approved	Revision Date



Drawn	Designed	Approved	Revision Date
JDR	PG	PG	15/03/12

Project No.	Scale
5C1814.00	1:400(A1)

Project	
NEW ZEALAND TRANSPORT AGENCY PEKA PEKA TO NORTH OTAKI EXPRESSWAY SCHEME ASSESSMENT	
Sheet	
Structures Plans Bridge No. 9 Mary Crest plan	
Drawing No.	Sheet No.
104866-S14	S14
Revision	R0



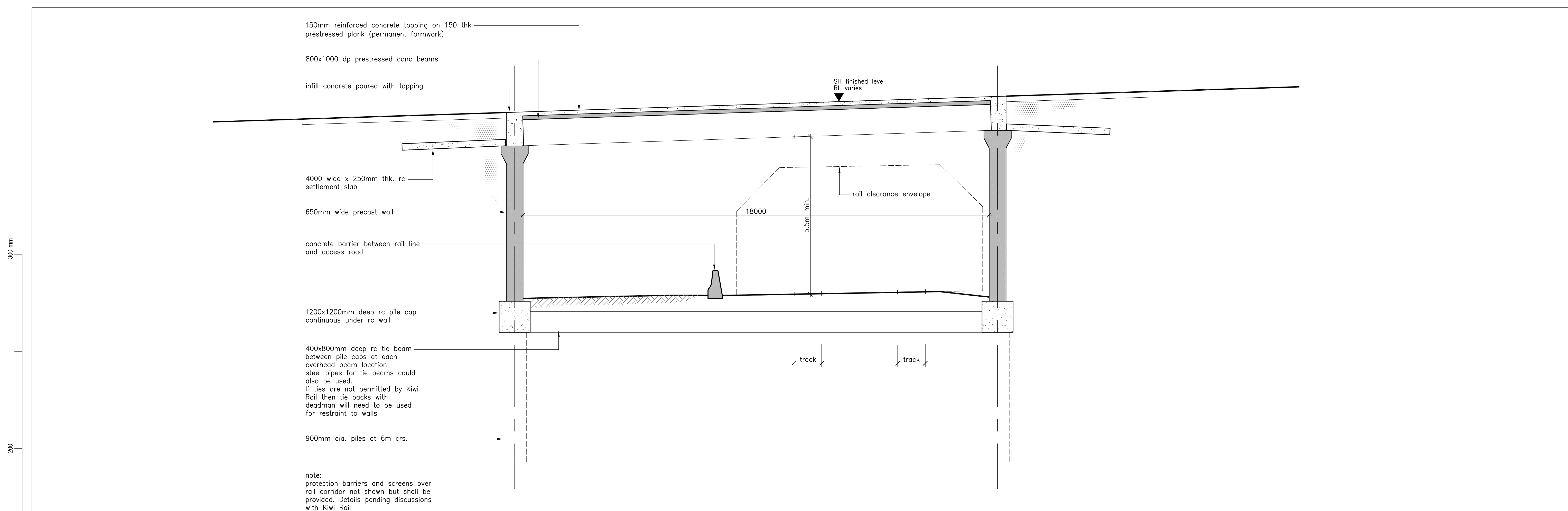

1  
S14  
bridge cross section  
1:75

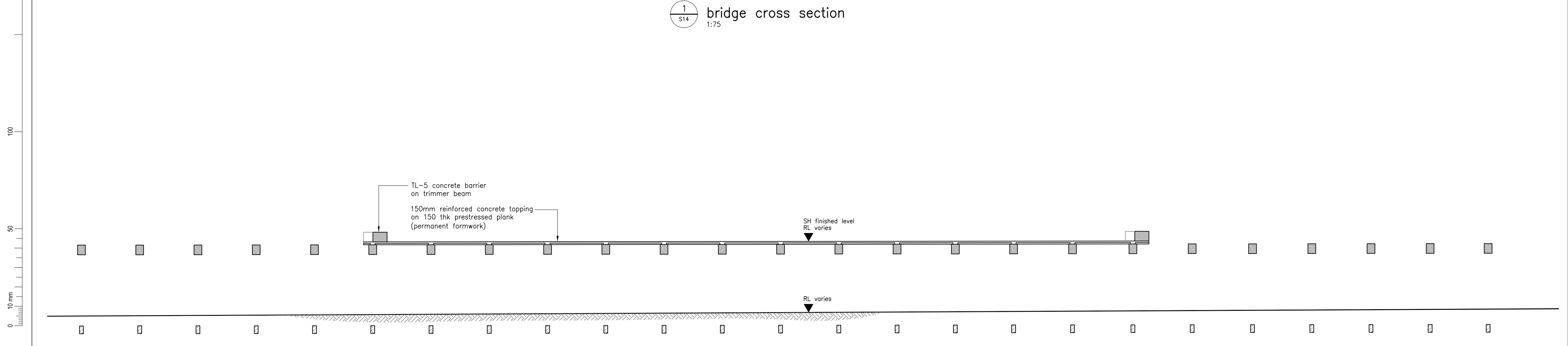

2  
S14  
bridge long section along centreline of structure  
1:200

Revision	Amendment	Approved	Revision Date



Drawn	Designed	Approved	Revision Date
JDR	PG	PG	15/03/12
Project No. 5C1814.00		Scale as shown(A1)	Drawing No. 104866-S15

Project NEW ZEALAND TRANSPORT AGENCY PEKA PEKA TO NORTH OTAKI EXPRESSWAY SCHEME ASSESSMENT			
Sheet Structures Plans Bridge No. 9 Mary Crest section & long section			
Sheet No. S15	Revision R0		

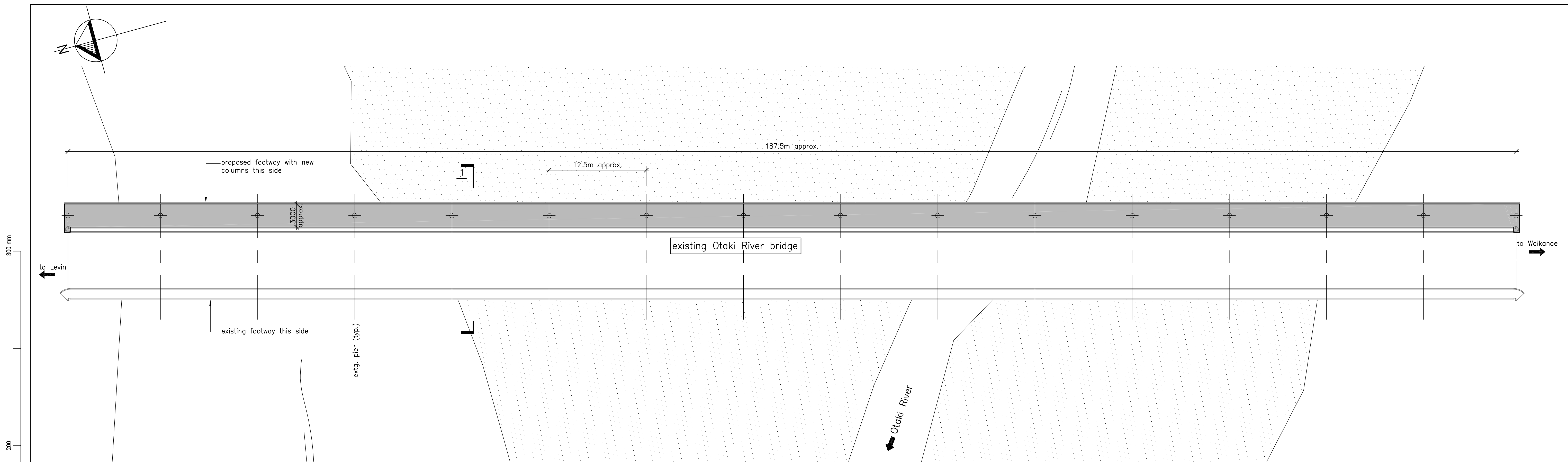

bridge general arrangement plan  
1:250

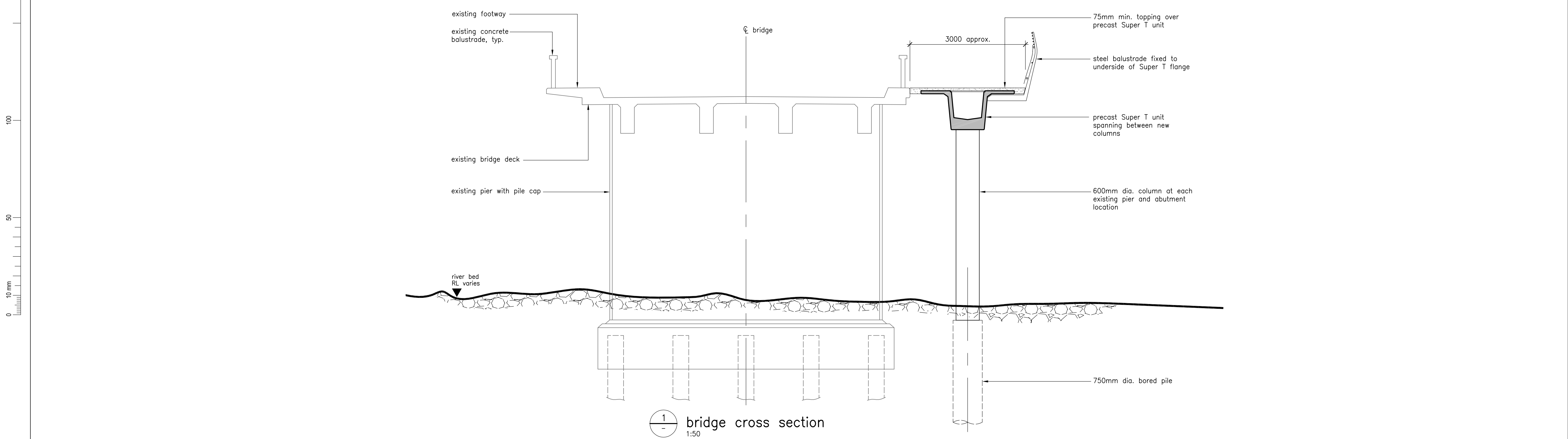

bridge cross section  
1:50

Revision	Amendment	Approved	Revision Date



Drawn	Designed	Approved	Revision Date
JDR	PG	PG	15/03/12
Project No.	Scale	Drawing No.	
G	as shown(A1)	104866-S16	

Project			
NEW ZEALAND TRANSPORT AGENCY PEKA PEKA TO NORTH OTAKI EXPRESSWAY SCHEME ASSESSMENT			
Sheet			
Structures Plans Bridge No. 10 existing Otaki River new footway details			
Sheet No.	Revision		
S16	R0		