

LEGEND

- EXISTING LEVEL
- DESIGN LEVEL

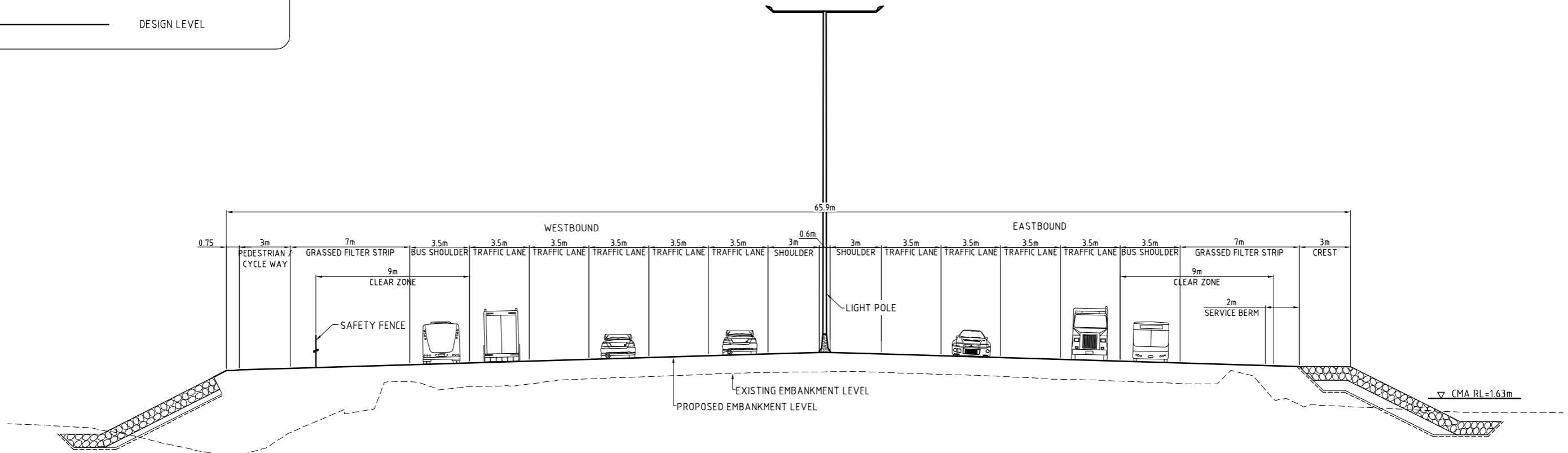

TYPICAL CROSS SECTION THROUGH CAUSEWAY

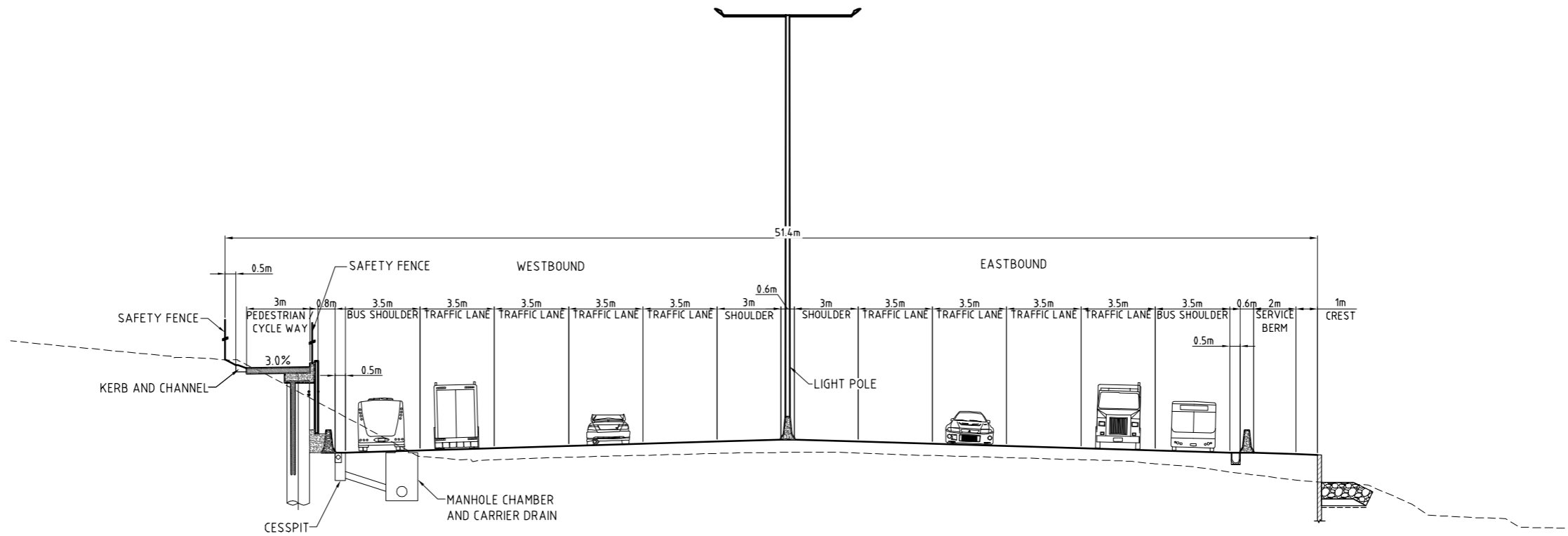

TYPICAL CROSS SECTION BETWEEN ROSEBANK ROAD AND PATIKI ROAD WITH RETAINING WALL

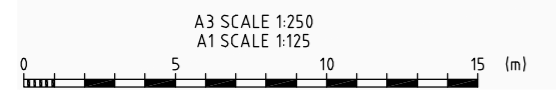

No.	Revision	By	Chk	Appd	Date
B	ISSUED FOR STATUTORY APPROVAL	AG	COB	JH	02.08.10
A	ISSUED FOR SRT/NZTA REVIEW	AG	COB	JH	23.06.10

Drawing Originator:
aurecon
Aurecon New Zealand Limited
139 Carlton Gore Road (PO Box 9762) Newmarket, Auckland New Zealand
Telephone: +64 9 520-8019
Facsimile: +61 9 524-7816
Email: auckland@aurecongroup.com

Original Scale (A1)	1:125	Designer	AG
Reduced Scale (A3)	1:250	Reviewer	COB
		Drafting Checked	WC
		Consultant Approval	JH
		Received by	Beca



Project: **WATERVIEW CONNECTION PROJECT**
SH16 / SH20

Title: **TYPICAL CROSS SECTIONS SHEET 1**

FOR APPROVAL
NOT FOR CONSTRUCTION

Base Level:	MSL AUCK. VERT. DATUM 1946
Grid Reference:	MT EDEN 2000
Originator No.	
Project No.	20111-3-D-C-101-201
Rev.	B

LEGEND

----- EXISTING LEVEL

———— DESIGN LEVEL

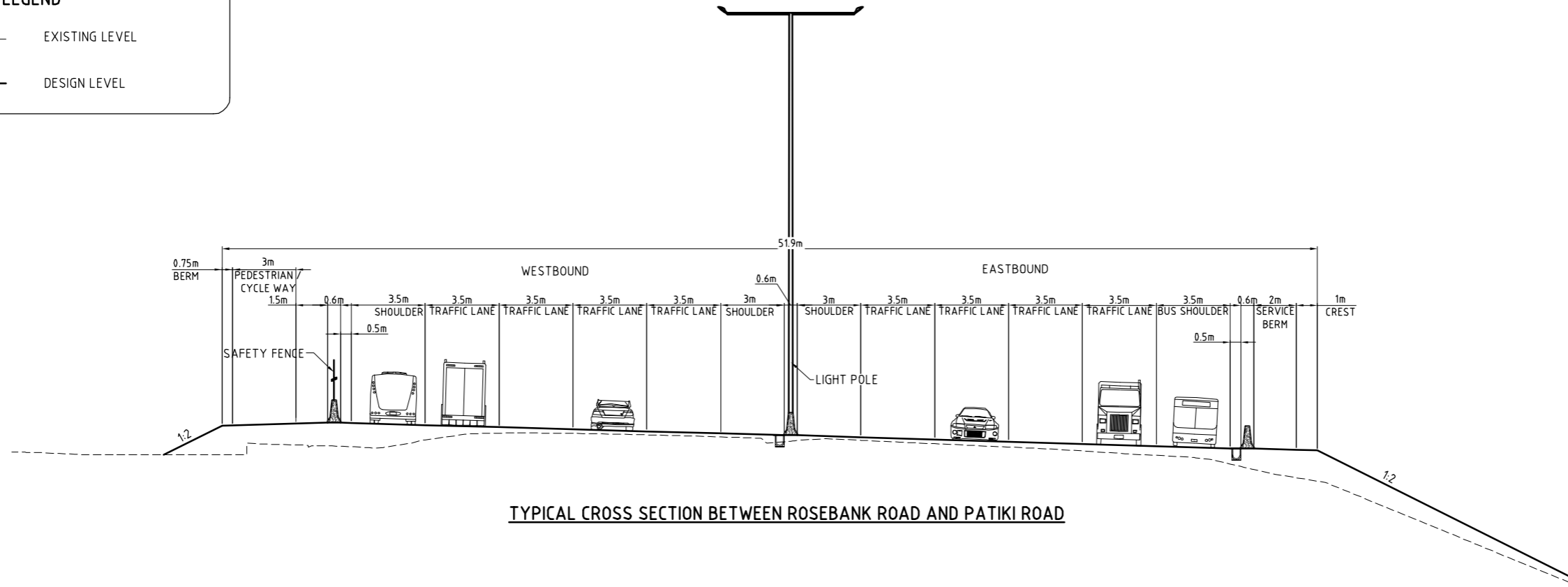

TYPICAL CROSS SECTION BETWEEN ROSEBANK ROAD AND PATIKI ROAD

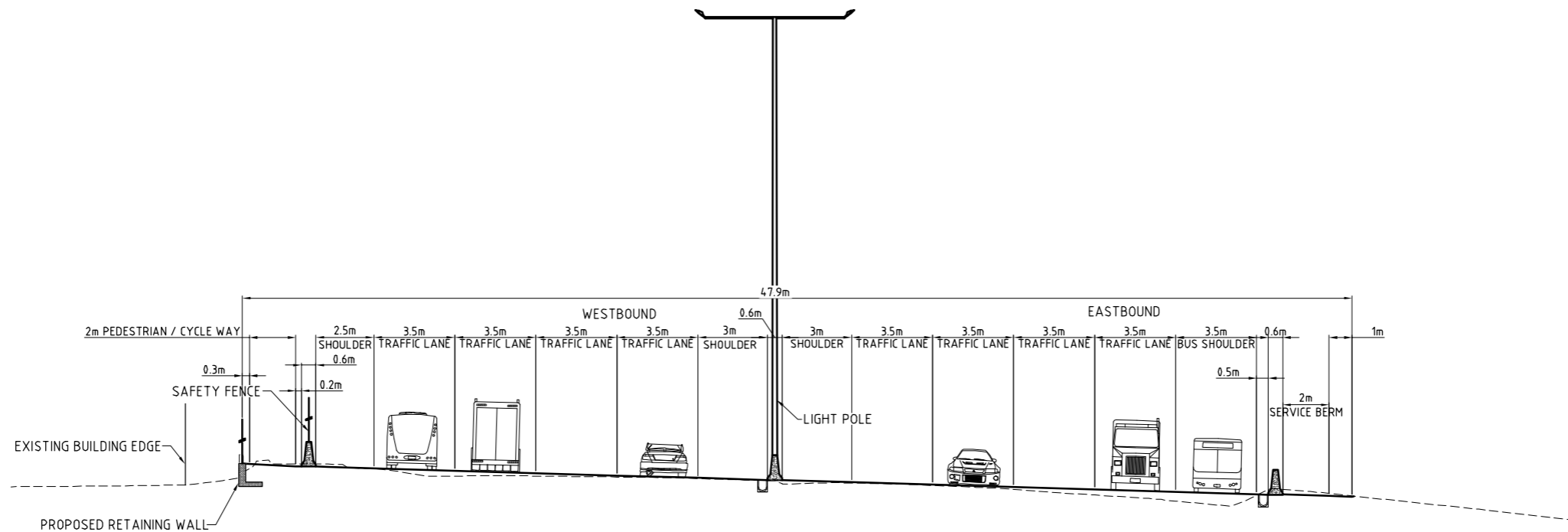

CROSS SECTION SHOWING SHOULDER REDUCTION
REQUIRED TO AVOID INDUSTRIAL BUILDING



FOR APPROVAL
NOT FOR CONSTRUCTION

Base Level: MSL AUCK. VERT. DATUM 1946	
Grid Reference: MT EDEN 2000	
Originator No.	
Project No. 20111-3-D-C-101-202	Rev. B

No.	Revision	By	Chk	Appd	Date
B	ISSUED FOR STATUTORY APPROVAL	AG	COB	JH	02.08.10
A	ISSUED FOR SRT/NZTA REVIEW	AG	COB	JH	23.06.10

Drawing Originator:

aurecon

Aurecon New Zealand Limited
139 Carlton Gore Road (PO Box 9762) Newmarket Auckland New Zealand
Telephone: +64 9 520-8019
Facsimile: +61 9 524-7816
Email: auckland@aurecongroup.com

Original Scale (A1)	1:125	Designer	AG
Reduced Scale (A3)	1:250	Reviewer	COB
		Drafting Checked	WC
		Consultant Approval	JH
		Received by	Beca

NZ TRANSPORT AGENCY
WAKA KOTAHU

Project: **WATERVIEW CONNECTION PROJECT**
SH16 / SH20

Title: **TYPICAL CROSS SECTIONS SHEET 2**

LEGEND

----- EXISTING LEVEL

———— DESIGN LEVEL

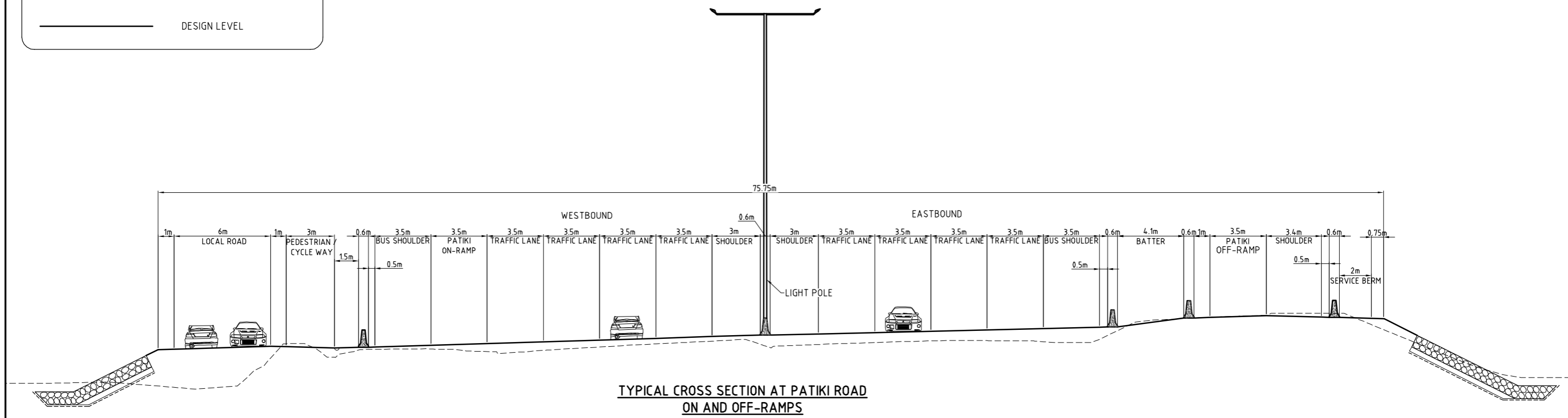

**TYPICAL CROSS SECTION AT PATIKI ROAD
ON AND OFF-RAMPS**

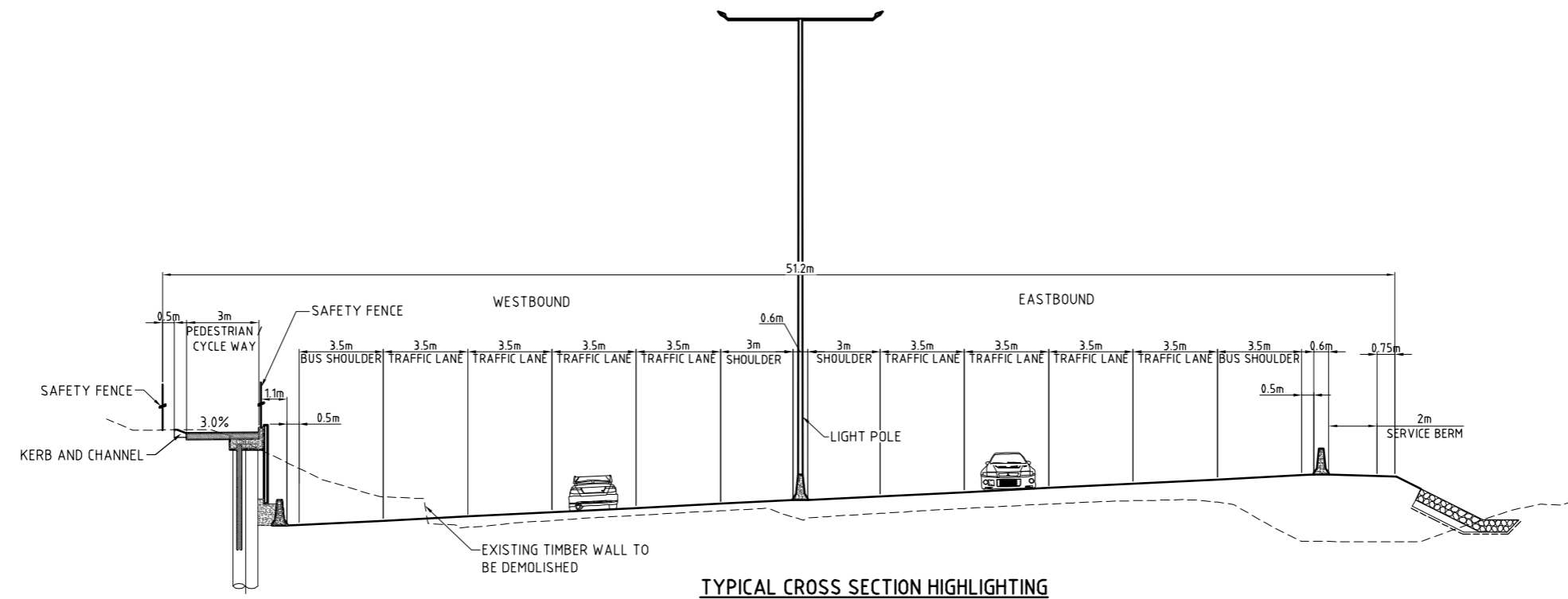

**TYPICAL CROSS SECTION HIGHLIGHTING
RETAINING WALL AT ROSEBANK DOMAIN RACEWAY**

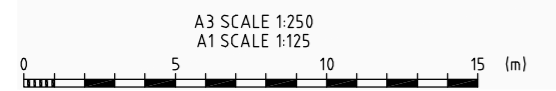

**FOR INFORMATION
NOT FOR CONSTRUCTION**

Base Level:	MSL AUCK. VERT. DATUM 1946
Grid Reference:	MT EDEN 2000
Originator No.	
Project No.	20111-3-D-C-101-203
Rev.	B

No.	Revision	By	Chk	Appd	Date
B	ISSUED FOR STATUTORY APPROVAL	AG	COB	JH	02.08.10
A	ISSUED FOR SRT/NZTA REVIEW	AG	COB	JH	23.06.10

Drawing Originator:

aurecon

Aurecon New Zealand Limited
139 Carlton Gore Road (PO Box 9762) Newmarket, Auckland, New Zealand
Telephone: +64 9 520-8019
Facsimile: +61 9 524-7816
Email: auckland@aurecongroup.com

Original Scale (A1)	1:125	Designer	AG
Reduced Scale (A3)	1:250	Reviewer	COB
		Drafting Checked	WC
		Consultant Approval	JH
		Received by Beca	--

NZ TRANSPORT AGENCY
WAKA KOTAHĪ

Project: **WATERVIEW CONNECTION PROJECT**
SH16 / SH20

Title: **TYPICAL CROSS SECTIONS SHEET 3**

LEGEND

----- EXISTING LEVEL

———— DESIGN LEVEL

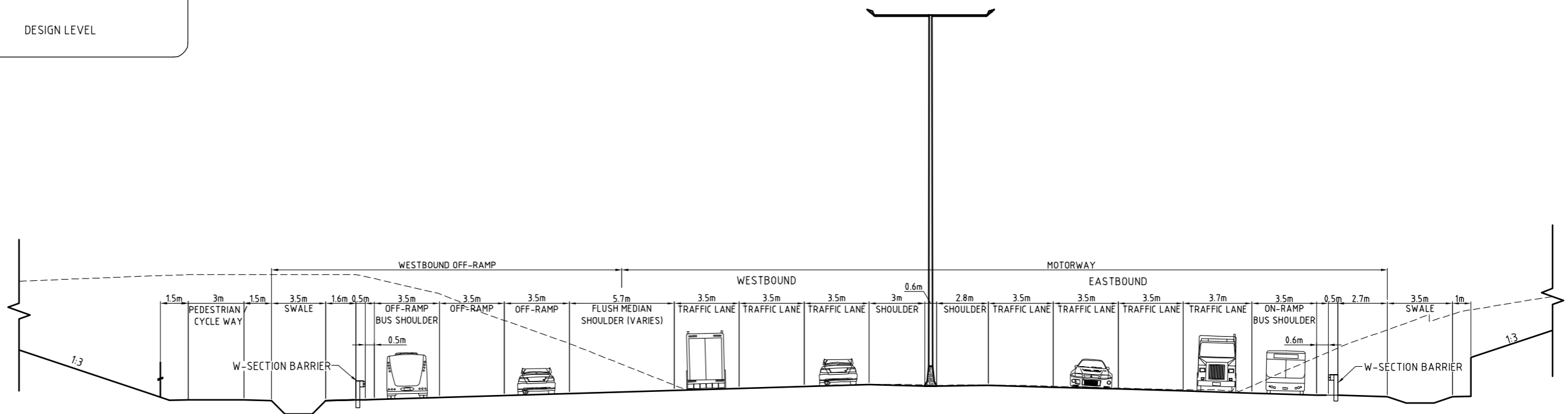

TYPICAL CROSS SECTION AT TE ATATU INTERCHANGE

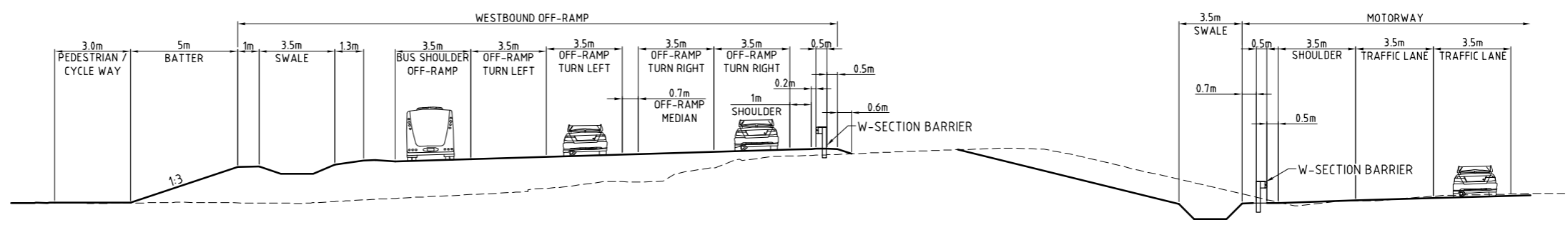

TYPICAL CROSS SECTION AT TE ATATU INTERCHANGE WESTBOUND OFF-RAMP



FOR APPROVAL
NOT FOR CONSTRUCTION

Base Level: MSL AUCK. VERT. DATUM 1946	
Grid Reference: MT EDEN 2000	
Originator No.	
Project No. 2011-3-D-C-101-204	Rev. B

No.	Revision	By	Chk	Appd	Date
B	ISSUED FOR STATUTORY APPROVAL	AG	COB	JH	02.08.10
A	ISSUED FOR SRT/NZTA REVIEW	AG	COB	JH	23.06.10

Drawing Originator:
aurecon
Aurecon New Zealand Limited
139 Carlton Gore Road (PO Box 9762) Newmarket, Auckland, New Zealand
Telephone: +64 9 520-8019
Facsimile: +61 9 524-7816
Email: auckland@aurecongroup.com

Original Scale (A1) 1:125	Designer AG
Reduced Scale (A3) 1:250	Reviewer COB
	Drafting Checked WC
	Consultant Approval JH
	Received by Beca ---

NZ TRANSPORT AGENCY
WAKA KOTAHU

Project: **WATERVIEW CONNECTION PROJECT**
SH16 / SH20

Title: **TYPICAL CROSS SECTIONS SHEET 4**

LEGEND

— DESIGN LEVEL

- - - EXISTING LEVEL

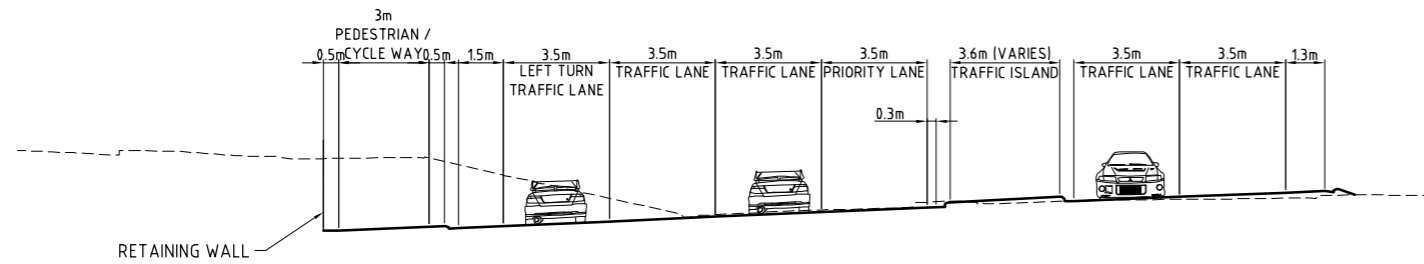

TYPICAL CROSS SECTION ON TE ATATU ROAD SOUTH OF WESTBOUND OFF RAMP INTERSECTION

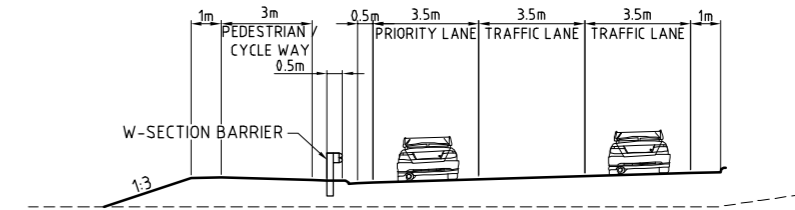

TYPICAL CROSS SECTION AT TE ATATU INTERCHANGE EASTBOUND ON-RAMP

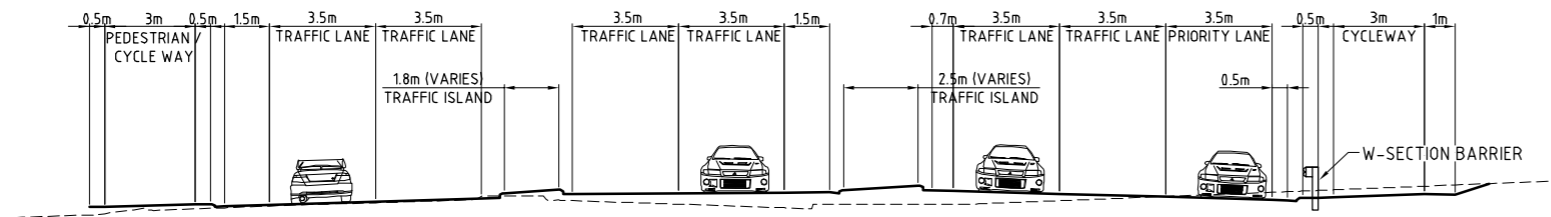

TYPICAL CROSS SECTION ON TE ATATU ROAD NORTH OF EASTBOUND OFF-RAMP INTERSECTION

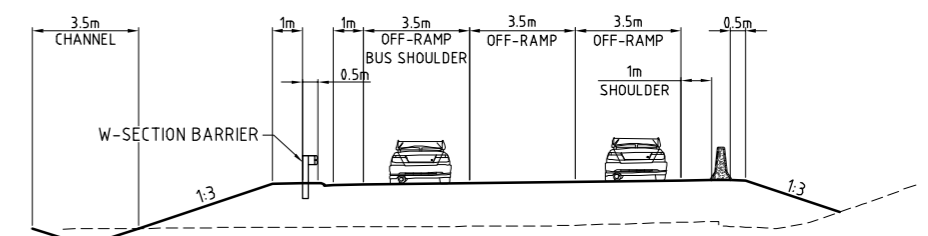

TYPICAL CROSS SECTION AT TE ATATU INTERCHANGE EASTBOUND OFF-RAMP



No.	Revision	By	Chk	Appd	Date
B	ISSUED FOR STATUTORY APPROVAL	AG	COB	JH	02.08.10
A	ISSUED FOR SRT/NZTA REVIEW	AG	COB	JH	23.06.10

Drawing Originator:

aurecon

Aurecon New Zealand Limited
139 Carlton Gore Road (PO Box 9762) Newmarket Auckland New Zealand
Telephone: +64 9 520-8019
Facsimile: +61 9 524-7816
Email: auckland@aurecongroup.com

Original Scale (A1)	1:125	Designer	AG
Reduced Scale (A3)	1:250	Reviewer	COB
		Drafting Checked	WC
		Consultant Approval	JH
		Received by Beca	--

NZ TRANSPORT AGENCY
WAKA KOTAHĪ

Project: **WATERVIEW CONNECTION PROJECT**
SH16 / SH20

Title: **TYPICAL CROSS SECTIONS SHEET 5**

FOR APPROVAL
NOT FOR CONSTRUCTION

Base level: **MSL AUCK. VERT. DATUM 1946**
Grid Reference: **MT EDEN 2000**

Originator No. _____
Project No. **20111-3-D-C-101-205** Rev. **B**

LEGEND

----- EXISTING LEVEL

———— DESIGN LEVEL

NOTES:
1. NUMBER OF LANES ON A RAMP VARIES BETWEEN 1 OR 2.

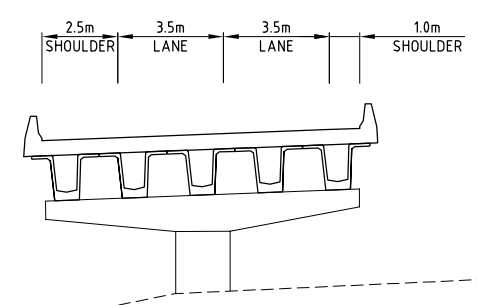

TYPICAL CROSS SECTION THROUGH INTERCHANGE RAMP

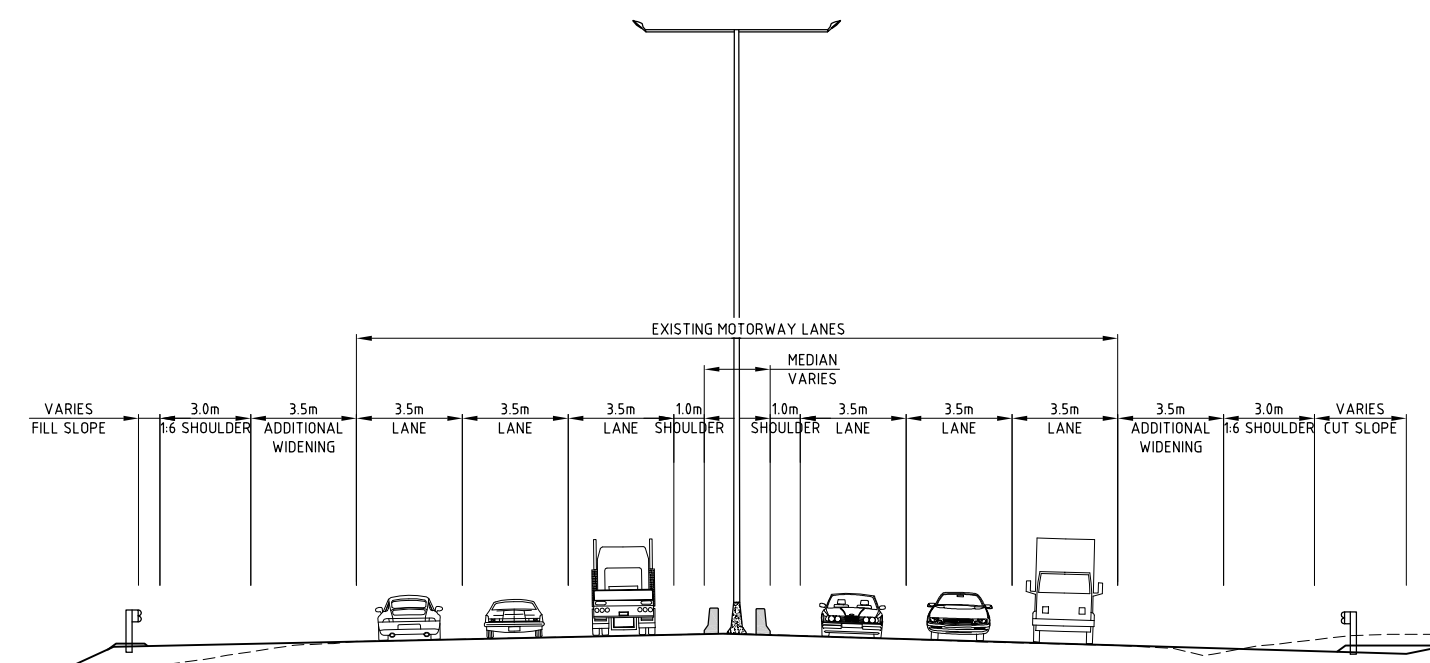

TYPICAL WIDENING TREATMENT SECTOR 6 SH16 (APPROX CH -1000)



FOR APPROVAL
NOT FOR CONSTRUCTION

Base level: MSL AUCK. VERT. DATUM 1946	
Grid Reference: Mt Eden 2000	
Originator No.	
Project No. 20.1.11-3-D-C-101-301	Rev. C

No.	Revision	By	Chk	Appd	Date
C	ISSUE FOR STATUTORY APPROVAL	BNRB			22.07.10
B	ISSUE FOR CONCEPT DESIGN REPORT	ME			12.07.10
A	ISSUE FOR SRT/NZTA REVIEW	BNRB			15.04.10

Drawing Originator:

Original Scale (A1) 1:125	Designer RP
Reduced Scale (A3) 1:250	Reviewer RM
	Drafting Checked BD
	Consultant Approval AL
	Beca Approval
	NZTA Approval

Project: WATERVIEW CONNECTION PROJECT
SH16 / SH20

Title: TYPICAL CROSS SECTIONS
SHEET 6

LEGEND

----- EXISTING LEVEL

———— DESIGN LEVEL

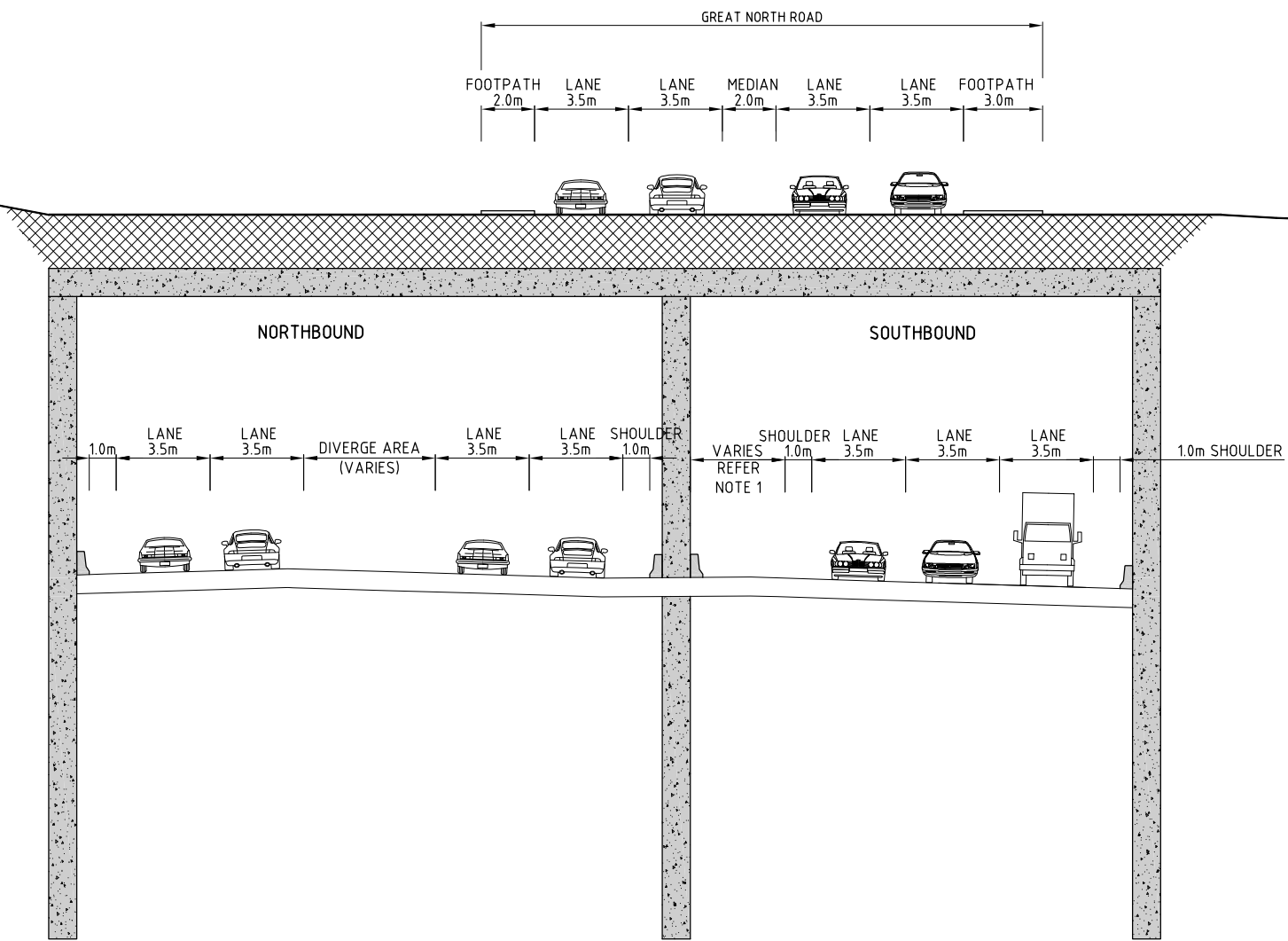

- NOTES**
1. WIDTH OF SHOULDER VARIES TO ACCOMMODATE TIE-IN WITH BORED TUNNEL SEPARATION
 2. VENT BUILDING NOT SHOWN

TYPICAL CROSS SECTION AT CUT & COVER, SECTOR 7 (APPROX CH 4150)

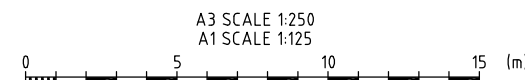

No.	Revision	By	Chk	Appd	Date
C	ISSUE FOR STATUTORY APPROVAL	BNRB			22.07.10
B	ISSUE FOR CONCEPT DESIGN REPORT	ME			12.07.10
A	ISSUE FOR SRT/NZTA REVIEW	BNRB			15.04.10

Drawing Originator:

Original Scale (A1)	1:125	Designer	RP
Reviewer	RM	Drafting Checked	BD
Reduced Scale (A3)	1:250	Consultant Approval	AL
Beca Approval		NZTA Approval	

Project: WATERVIEW CONNECTION PROJECT SH16 / SH20

Title: TYPICAL CROSS SECTION SHEET 7

FOR APPROVAL NOT FOR CONSTRUCTION

Base Level: MSL AUCK. VERT. DATUM 1946
Grid Reference: Mt Eden 2000

Originator No. _____

Project No. 20.1.11-3-D-C-101-302 Rev. C

LEGEND

----- EXISTING LEVEL

———— DESIGN LEVEL

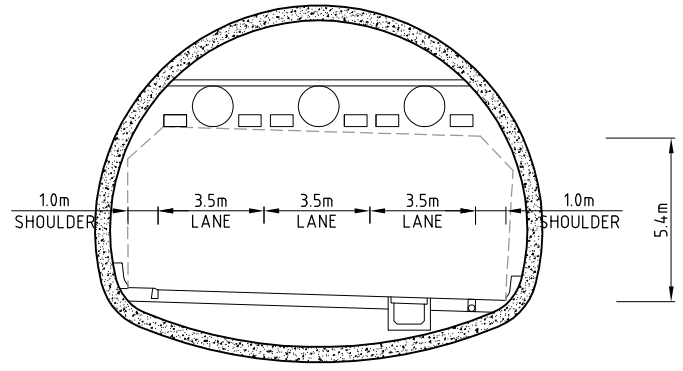

TYPICAL TUNNEL CROSS SECTION

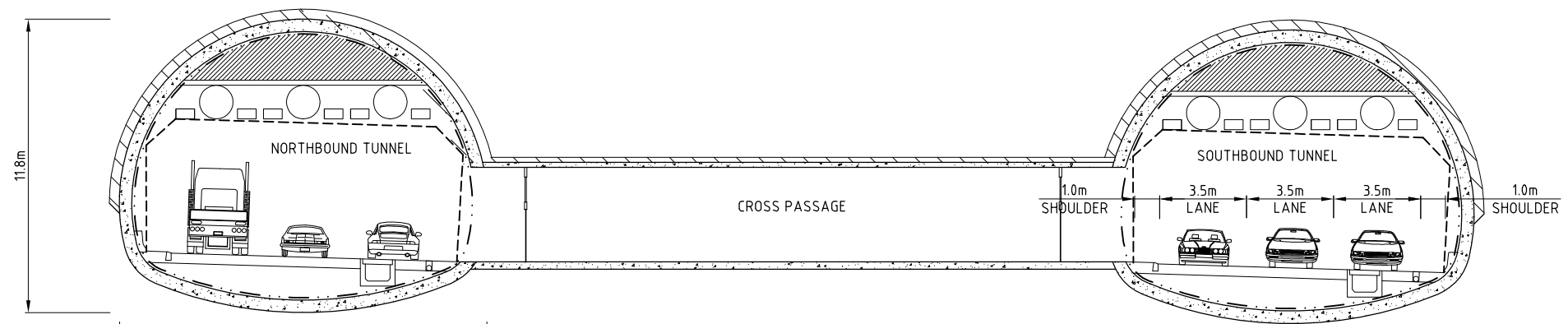

TYPICAL TUNNEL CONFIGURATION
SECTOR 8- TYPICAL CROSS SECTION CONFIGURATION AT CROSS-PASSAGE

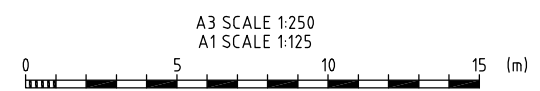

FOR APPROVAL
NOT FOR CONSTRUCTION

Base level: MSL AUCK. VERT. DATUM 1946	
Grid Reference: Mt Eden 2000	
Originator No.	
Project No. 20.1.11-3-D-C-101-303	Rev. C

No.	Revision	By	Chk	Appd	Date
C	ISSUE FOR STATUTORY APPROVAL	BNRB			22.07.10
B	ISSUE FOR CONCEPT DESIGN REPORT	ME			12.07.10
A	ISSUE FOR SRT/NZTA REVIEW	BNRB			15.04.10

Drawing Originator:

Original Scale (A1) 1:125	Designer RP
Reduced Scale (A3) 1:250	Reviewer RM
	Drafting Checked BD
	Consultant Approval AL
	Beca Approval
	NZTA Approval

NZ TRANSPORT AGENCY
WAKA KOTAHI

Project: WATERVIEW CONNECTION
PROJECT
SH16 / SH20

Title: TYPICAL CROSS SECTION
SHEET 8

LEGEND

----- EXISTING LEVEL

———— DESIGN LEVEL

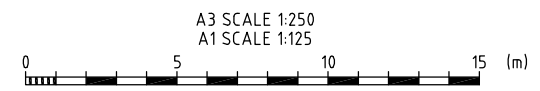
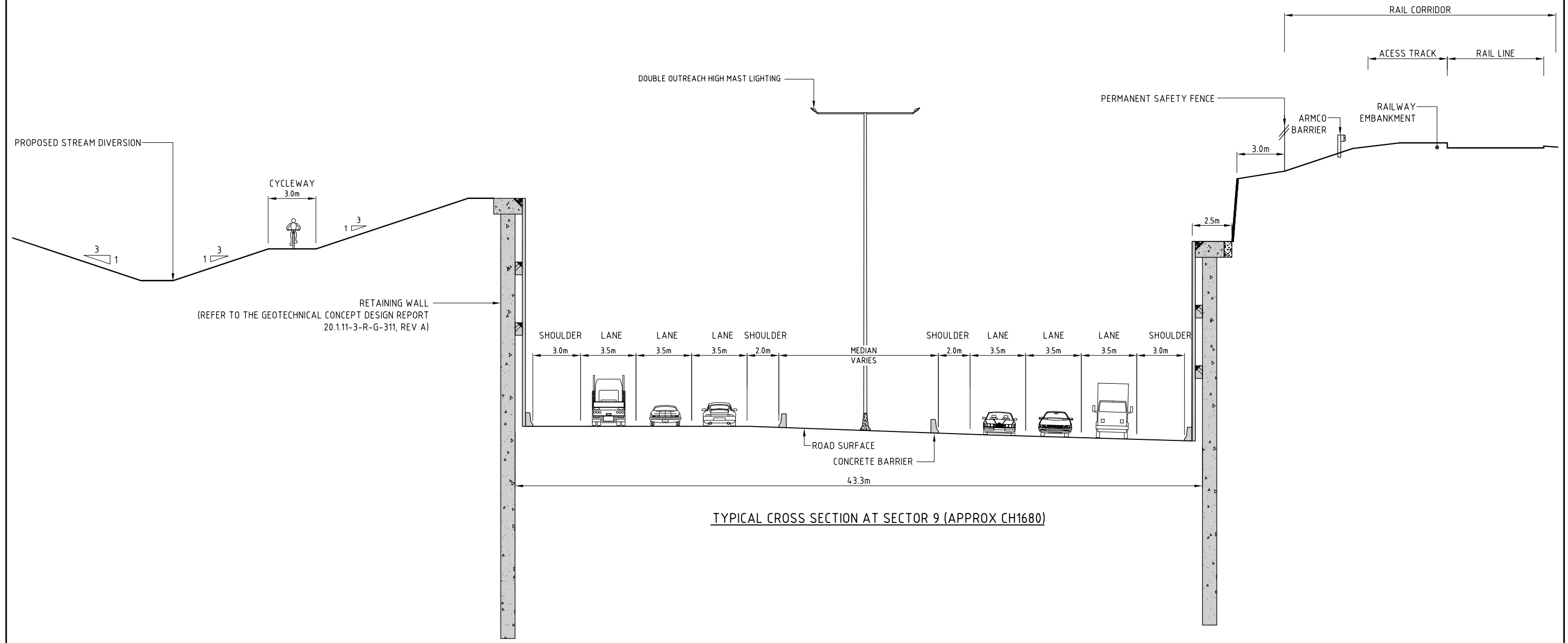

No.	Revision	By	Chk	Appd	Date
C	ISSUE FOR STATUTORY APPROVAL	BNRB			22.07.10
B	ISSUE FOR CONCEPT DESIGN REPORT	ME			12.07.10
A	ISSUE FOR SRT/NZTA REVIEW	BNRB			15.04.10

Drawing Originator:

Original Scale (A1)	1:125	Designer	RP
Reduced Scale (A3)	1:250	Reviewer	RM
		Drafting Checked	BD
		Consultant Approval	AL
		Beca Approval	
		NZTA Approval	

Project: **WATERVIEW CONNECTION PROJECT SH16 / SH20**

Title: **TYPICAL CROSS SECTION SHEET 9**

FOR APPROVAL NOT FOR CONSTRUCTION

Base Level: **MSL AUCK. VERT. DATUM 1946**

Grid Reference: **Mt Eden 2000**

Originator No.:

Project No. **20.11-3-D-C-101-304** Rev. **C**

LEGEND

----- EXISTING LEVEL

———— DESIGN LEVEL

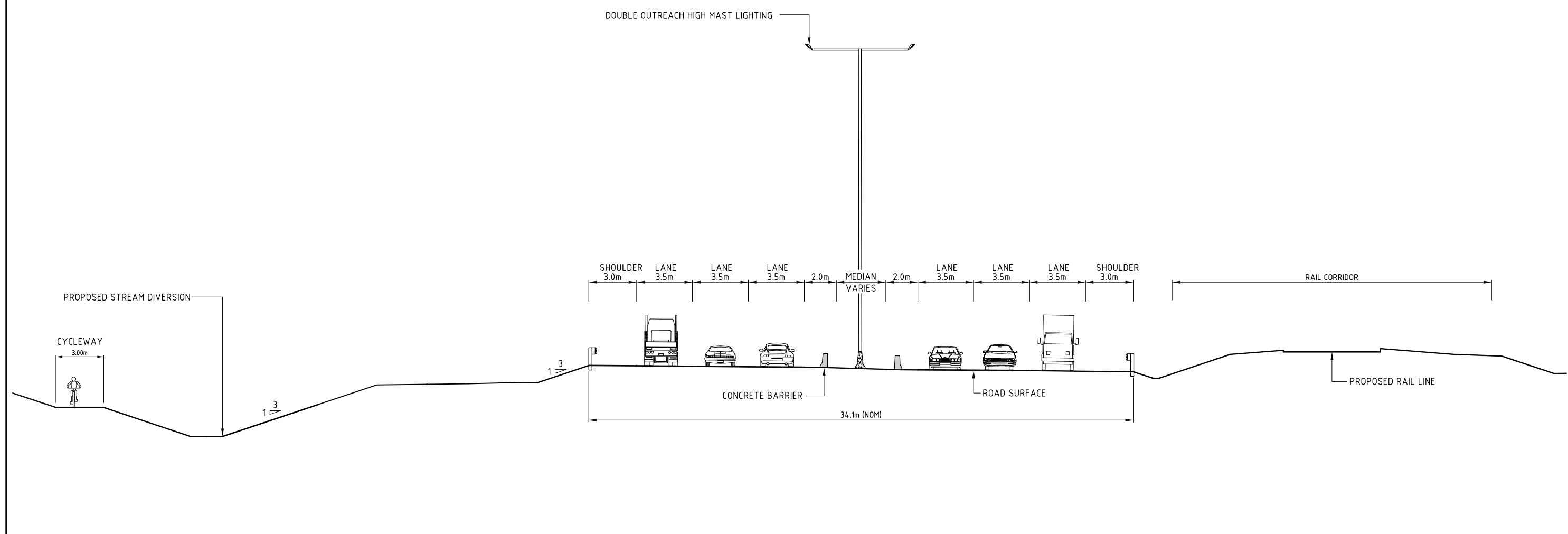

TYPICAL CROSS SECTION AT SECTOR 9 (APPROX CH1200)

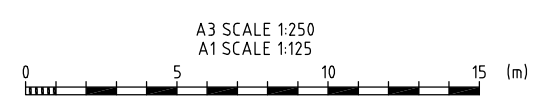

No.	Revision	By	Chk	Appd	Date
C	ISSUE FOR STATUTORY APPROVAL	BNRB			22.07.10
B	ISSUE FOR CONCEPT DESIGN REPORT	ME			12.07.10
A	ISSUE FOR SRT/NZTA REVIEW	BNRB			15.04.10

Drawing Originator:

Original Scale (A1)	1:125	Designer	RP
Reduced Scale (A3)	1:250	Reviewer	RM
		Drafting Checked	BD
		Consultant Approval	AL
		Beca Approval	
		NZTA Approval	

Project: WATERVIEW CONNECTION PROJECT SH16 / SH20

Title: TYPICAL CROSS SECTION SHEET 10

FOR APPROVAL
NOT FOR CONSTRUCTION

Base level: MSL AUCK. VERT. DATUM 1946
Grid Reference: Mt Eden 2000

Originator No. _____

Project No. 20.1.11-3-D-C-101-305 Rev. C